

INVERTER FR-F800

Enhanced Next-Generation Energy-Saving Inverter
[Addition of the IP55 compatible model]



- Energy saving
- Functions ideal for fans and pumps
- Security & safety
- Compatibility with the environment
- Easy setup & operation

GLOBAL IMPACT OF MITSUBISHI ELECTRIC



Through Mitsubishi Electric's vision, "Changes for the Better" are possible for a brighter future.

Changes for the Better

"Changes for the Better" represents the Mitsubishi Electric Group's attitude to "always strive to achieve something better", as we continue to change and grow. Each one of us shares a strong will and passion to continuously aim for change, reinforcing our commitment to creating "an even better tomorrow".

Mitsubishi Electric is involved in many areas including the following:

Energy and Electric Systems

A wide range of power and electrical products from generators to large-scale displays.

Electronic Devices

A wide portfolio of cutting-edge semiconductor devices for systems and products.

Home Appliance

Dependable consumer products like air conditioners and home entertainment systems.

Information and Communication Systems

Commercial and consumer-centric equipment, products and systems.

Industrial Automation Systems

Maximizing productivity and efficiency with cutting-edge automation technology.

The Mitsubishi Electric Group is actively solving social issues, such as decarbonization and labor shortages, by providing production sites with energy-saving equipment and solutions that utilize automation systems, thereby helping towards a sustainable society.



Features	4	1
Example Applications, PLC Functions, FR Configurator2	15	2
Example Connection	20	3
Standard Specifications	21	4
Outline Dimensions	27	5
Terminal Connection Diagram, Terminal Specifications	39	6
Operation Panel (FR-DU08(-01)) and LCD Operation Panel (FR-LU08(-01))	49	7
Operation Steps	54	8
Parameter List	65	9
Protective Functions	87	10
Option and Peripheral Devices	90	11
Low-Voltage Switchgear/Cables	111	12
Precaution on Selection and Operation	117	13
Compatible Motors	124	14
Compatibility	140	15
Warranty	144	16

1

ENERGY SAVING

Energy Saving with Inverters

The consumed power of a variable-torque load, such as fans, pumps, and blowers, is proportional to the cube of its rotation speed. Adjusting the air volume by the inverter rotation speed control can lead to energy savings.

[Example of blower operation characteristic]

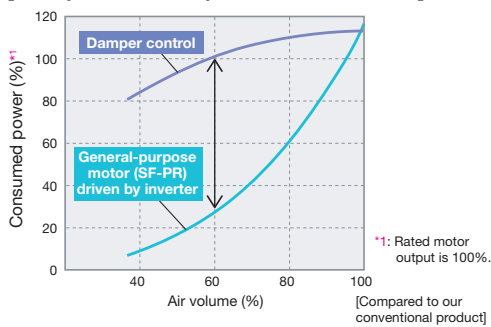

Utilizing the motor capability to the full

Optimum excitation control

- Optimum excitation control continuously adjusts the excitation current to an optimum level to provide the highest motor efficiency. With a small load torque, a substantial energy saving can be achieved. For example, at 4% motor load torque for a general-purpose motor, the motor efficiency under Optimum excitation control is about 30% higher than the motor efficiency under V/F control.

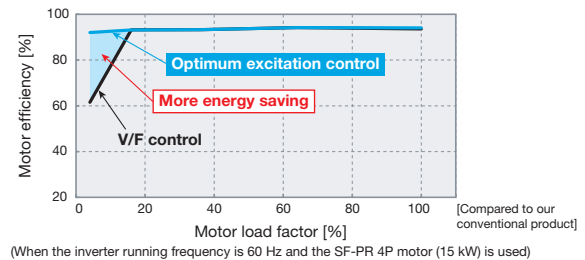

NEW Improving starting torque and saving energy at the same time

Advanced optimum excitation control

Advanced optimum excitation control, which has been newly developed, provides a large starting torque while maintaining the motor efficiency under the conventional Optimum excitation control. Without the need of troublesome adjustment of parameters (acceleration/deceleration time, torque boost, etc.), acceleration is done in a short time. Also, energy saving operation with the utmost improved motor efficiency is performed during constant-speed operation. To use Advanced optimum excitation control, set the energy saving control selection parameter (Pr.60) = "9" under Advanced magnetic flux vector control.



NEW Supporting operations of various motors

Offline auto tuning

The offline auto tuning function to measure circuit constants of the motor enables optimal operation of motors even when motor constants vary, when a non-Mitsubishi Electric motor is used, or when the wiring distance is long. Sensorless operation can be performed with Mitsubishi Electric general-purpose (induction) and PM motors (MM-EFS, MM-THE4) as well as non-Mitsubishi Electric general-purpose (induction) and PM motors*2.

The tuning function enables the Advanced optimum excitation control of non-Mitsubishi Electric general-purpose (induction) motors*2, which increases the usability in energy saving applications.

*2: Depending on the motor characteristics, tuning may not be available.

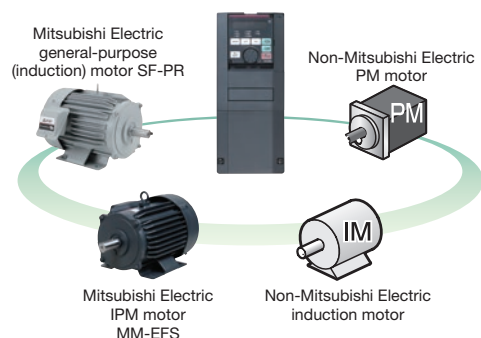

2 Energy Saving with High-Efficiency Motor

In the international context of global warming prevention, many countries in the world have started to introduce laws and regulations to mandate manufacturing and sales of high-efficiency motors. With the use of high-efficiency motors, further energy saving is achieved.

[IE code]

As an international standard of the efficiency, IEC60034-30 (energy-efficiency classes for single-speed, three-phase, cage-induction motors) was formulated in October 2008. The efficiency is classified into four classes from IE1 to IE4. The larger number means the higher efficiency.

Efficiency class IEC 60034-30	Mitsubishi Electric motor efficiency	
	General-purpose motor	IPM motor
IE4 (super premium efficiency)*1	—	Premium high-efficiency IPM (MM-EFS/MM-THE4)
IE3 (premium efficiency)	Superline premium series (SF-PR)	—
IE2 (high efficiency)	Superline eco series (SF-HR)	—
IE1 (standard efficiency)	Superline series (SF-JR)	—
Below the class	—	—

*1: The details of IE4 are specified in IEC 60034-31.

Further energy saving with the premium high-efficiency IPM motor

MM-EFS / MM-THE4

- The IPM motor, with permanent magnets embedded in the rotor, achieves even higher efficiency as compared to the general-purpose motor (SF-PR/SF-THE3).
- The IM driving setting can be switched to IPM driving setting by only one setting. ("12" (MM-EFS/MM-THE4) in the parameter [IPM]. Refer to **page 135** for details.)

Do not drive an IPM motor in the induction motor control settings.

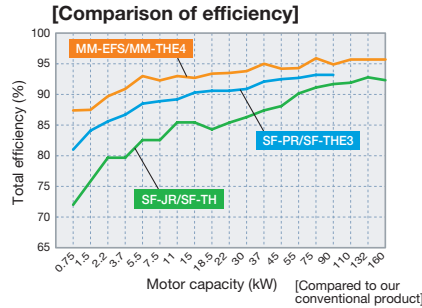

Why is an IPM motor more efficient?

- No current flows to the rotor (secondary side), and no secondary copper loss is generated.
- Magnetic flux is generated with permanent magnets, and less motor current is required.
- Embedded magnets provide reluctance torque*4, and the reluctance torque can be applied.

*4: Reluctance torque occurs due to magnetic imbalance on the rotor.

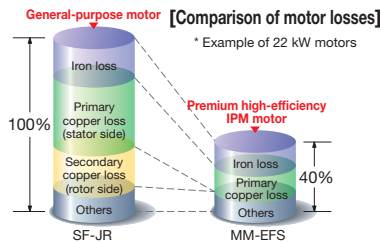

Excellent compatibility with the high-performance energy-saving motor

SF-PR

Motor constants are stored in the inverter. Energy-saving operation can be started just by setting parameters. The SF-PR motor conforms to the Japanese domestic Top Runner Standard (IE3 equivalent). Its energy-saving operation contributes reduction in the electricity charges, which in turn lowers the running cost.

Refer to **page 125** for the other features.

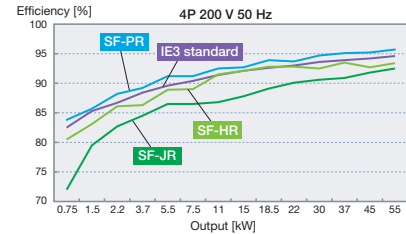

3 Energy-Saving Functions Suitable for Various Systems

Standby power reduction



- With the 24 VDC external power supply, the input MC signal can be turned OFF after the motor is stopped, and turned ON before activating the motor. The inverter enables self power management to reduce standby power.
- The inverter cooling fan can be controlled depending on the temperature of the inverter heatsink. Also, signals can be output in accordance with the inverter cooling fan operation. When the fan is installed on the enclosure, the enclosure fan can be synchronized with the inverter cooling fan. Extra power consumption when the motor is stopped can be reduced.

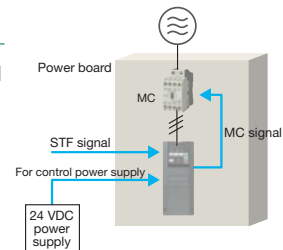

Energy saving at a glance

Energy saving monitor / Pulse train output of output power

- Energy saving monitor is available. The energy saving effect can be checked using an operation panel, output terminal, or network.
- The output power amount measured by the inverter can be output in pulses. The cumulative power amount can be easily checked.

(This function cannot be used as a meter to certify electricity billings.)



With the Mitsubishi Electric energy measuring module, the energy saving effect can be displayed, measured, and collected.

Effective use of the regenerative energy Option

FR-XC / FR-HC2

Multiple inverters can be connected to the multifunction regeneration converter (FR-XC) or the high power factor converter (FR-HC2) through a common PN bus. The regenerated energy is used by another inverter, and if there is still an excess, it is returned to the power supply, saving on the energy consumption. The 355 kW or higher models are inverter-converter separated types, which are suitable for power regeneration.



2

FUNCTIONS IDEAL FOR FANS AND PUMPS



1 Optimum Inverter Capacity Selection

Multiple rating

The rating can be selected between the two types (LD (light duty) or SLD (superlight duty)) depending on the load of the fan/pump to be used. The optimum inverter capacity can be selected suitable for the motor to be used.

For the 200 V class 90 kW or higher and the 400 V class 75 kW or higher, a motor with one-rank higher capacity can be combined.

Load	Rating	Overload current rating
Superlight duty	SLD rating	110% 60 s, 120% 3 s (inverse-time characteristics) at surrounding air temperature of 40°C
Light duty	LD rating	120% 60 s, 150% 3 s (inverse-time characteristics) at surrounding air temperature of 50°C

For the list of inverters by rating, refer to **page 13**.

2 Further Enhanced PID Control



System cost reduction **PID multiple loops (two loops)**

Two PID operation units are available in the inverter. The inverter can perform PID control of the motor operation and control the external equipment at the same time. The system cost can be reduced because no external PID controller is required for controlling the external equipment.

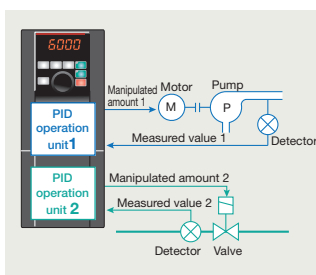

Water volume control with multiple pumps

Multi-pump function

By controlling the pumps connected in parallel (up to four pumps) by the PID control by one inverter, water volume, etc. can be adjusted.

One of the connected pumps is driven by the inverter. Other pumps are driven by commercial power supply. The number of pumps to be driven by commercial power supply is automatically adjusted according to the water volume.

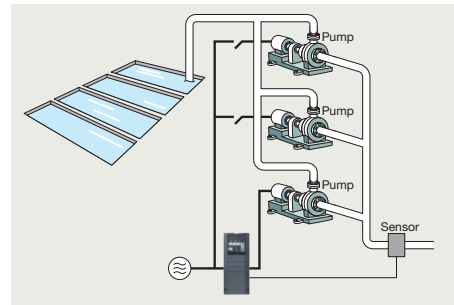

Direct setting of the PID set point

The PID set point can be set directly from the operation panel. The setting can be easily changed at hand.



Visibility improvement **Option**

With the optional LCD operation panel (FR-LU08), the unit can be changed from "% " to other easy-to-see units. Maintenance and adjustment is facilitated by using a familiar unit of air volume, temperature, etc. for indication.

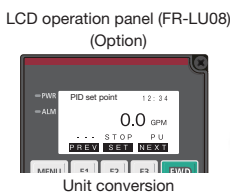

Pump water volume control

PID input pressure control

In order to prevent air intake and cavitation inside the pump, the pump inlet pressure can be controlled so that there is no water shortage.

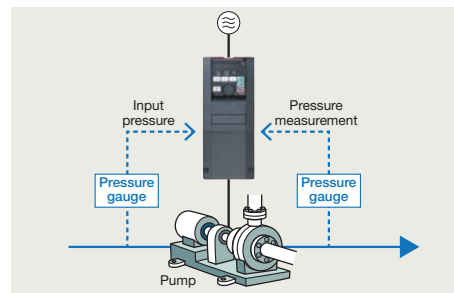

Avoidance of rapid acceleration/deceleration using PID action

PID pre-charge function

Before PID action, the water flow to the pipe is controlled by operating the motor at a constant speed until the measured value (pressure, etc.) reaches the set level. This function is used to avoid rapid acceleration/deceleration caused by starting the PID action while the pipe is empty, and prevent a water hammer action, etc.

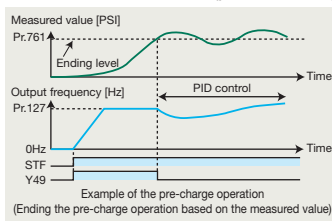

3 Operating Status Monitoring

NEW Detection of mechanical faults

Load characteristics measurement function

The speed/torque relationship is stored while no fault occurs. By comparing the present load status with the stored load characteristics, out-of-range warnings can be output if applicable. Mechanical faults such as clogging of the filter or breakage of the belt can be easily detected, and maintenance is facilitated.

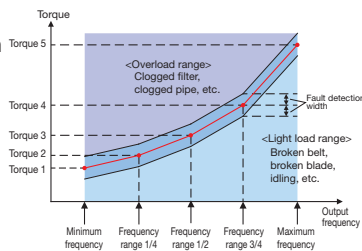

NEW Cleaning of fans and pumps

Cleaning function

Foreign matter on the impellers or fans of pumps can be removed by repeating forward/reverse rotation and stopping of the motor. (Use this function when a back flush does not pose a problem.) This function can be also automatically started when the result of load characteristics measurement is out of range (overload).

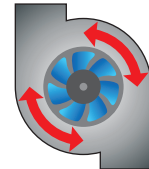

4 Smooth Restart

Automatic restart after instantaneous power failure / flying start function

After an instantaneous power failure, the operation is restartable from the coasting motor speed. With the advanced flying start function, the operation can be smoothly started from low speed.

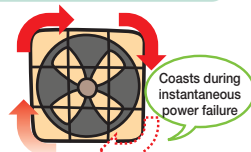

Automatic restart after instantaneous power failure function

5 Keep Running during Flying Start Operation

Regeneration avoidance function

The operation frequency is automatically increased to prevent the regenerative overvoltage fault from occurring. This function is useful when a load is forcibly rotated by another fan in the duct.

6 PLC Control with an Inverter

NEW PLC function in the inverter

- Parameters and setting frequency can be changed at the program. Control programs can be created in sequence ladders using the inverter setup software (FR Configurator2).
- Inverter control such as inverter operations triggered by input signals, signal output based on inverter operation status, and monitor output can be freely customized based on the machine specifications.
- All machines can be controlled by the inverter alone, and control can also be dispersed.
- Time-based operation is possible by using in combination with the real-time clock function (when using an optional LCD operation panel (FR-LU08)).

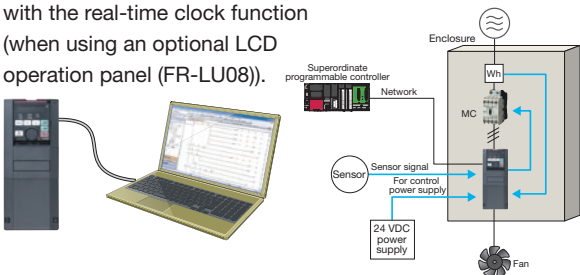

7 Compatibility with Various Systems

Compatibility with various networks

It supports BACnet® MS/TP as standard, as well as Mitsubishi inverter protocol and MODBUS®RTU (binary) protocol. Communication options are also available for major network protocols such as CC-Link, CC-Link IE Field Network, LONWORKS®, FL remote, PROFIBUS-DP V0, and DeviceNet™.

FR-F800-E

CC-Link IE Field Basic

The CC-Link IE Field Network Basic is supported, so the network can be created easily. The inverter's status can be monitored and the parameters can be set via Internet. (MODBUS/TCP and BACnet/IP are also supported.)

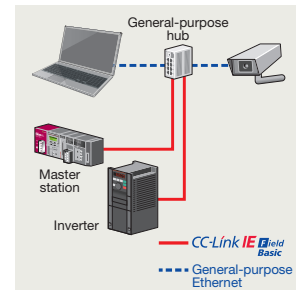

Simplified external equipment

The CA-type inverters are available. For the CA type, the monitor output terminal FM/CA operates as terminal CA (analog current output 0 to 20 mA), not as terminal FM (pulse train output). An external converter is not required. (The factory setting is different for the CA type and the FM type. (Refer to page 12.))

8 Mechanical Resonance Suppression

Speed smoothing control

Vibration caused by mechanical resonance can be reduced. (Enabled only under V/F control.)

9 Extended Functions

Support for up to three types of options

Three types of plug-in options can be attached. The functions of the inverter can be extended through network. For example, additional I/O terminals can be used.

3

SECURITY & SAFETY

1 Improved System Safety

NEW Safety standards compliance

Controls with safety functions can be easily performed.

The Safe Torque Off (STO) safety function is supported by the inverter. The FR-F800 inverter with the safety function complies with safety standards while incurring little expense.

- EN ISO 13849-1 PLd / Cat.3
- EN 61508, EN 61800-5-2 SIL2

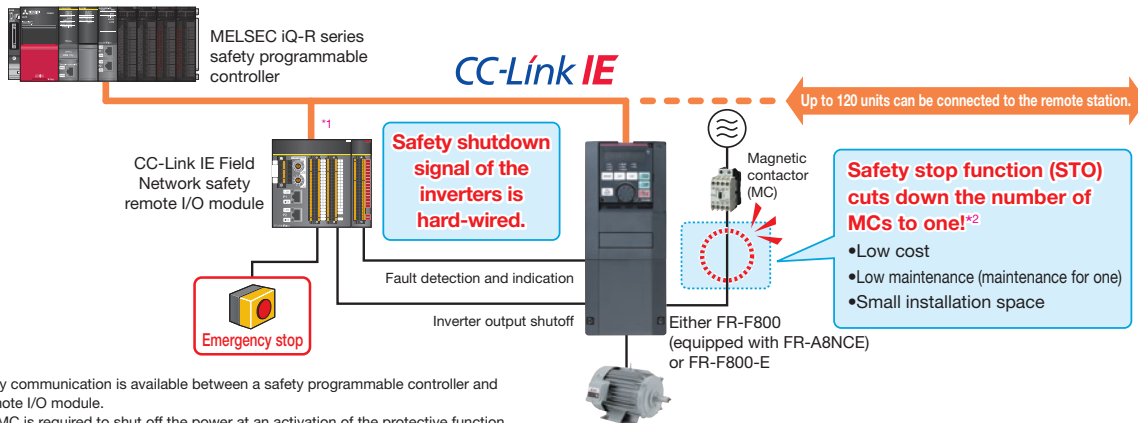

*1: Safety communication is available between a safety programmable controller and a remote I/O module.
 *2: One MC is required to shut off the power at an activation of the protective function.

2 Reliable and Secure Maintenance

NEW Standard 24 VDC power supply for the control circuit

In addition to the existing power supply input terminals (R1 and S1) of the control circuit, 24 VDC input is equipped as standard. The 24 VDC power supplied from outside can be fed to the control circuit locally.

The parameter setting and communication operation can be done without turning ON the main power.

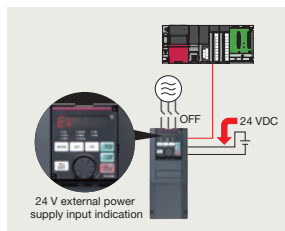

NEW Prevention of trouble with temperature monitoring

The inverter is equipped with an internal temperature sensor, which outputs a signal when the internal temperature is high. This facilitates the detection of rises in temperature inside the inverter following cooling fan malfunction, or rises in the surrounding air temperature due to inverter operating conditions.

3 Long Life Components and Life Check Function

Long life components

- The service life of the cooling fans is now 10 years*³. The service life can be further extended by ON/OFF control of the cooling fan.
- Capacitors with a design life of 10 years*³⁺⁴ are adapted.
- Life indication of life components

Components	Estimated lifespan of the FR-F800 ³⁾	Guideline of JEMA ⁵⁾
Cooling fan	10 years	2 to 3 years
Main circuit smoothing capacitor	10 years* ⁴	5 years
Printed board smoothing capacitor	10 years* ⁴	5 years

*³ Surrounding air temperature: Annual average of 40°C (free from corrosive gas, flammable gas, oil mist, dust and dirt). The design life is a calculated value from the LD rating and is not a guaranteed product life.

*⁴ Output current: 80% of the inverter LD rating

*⁵ Excerpts from "Periodic check of the transistorized inverter" of JEMA (Japan Electrical Manufacturer's Association).

NEW Enhanced life check function

- An internal thermal sensor is equipped to all inverters as standard, which enables monitoring of the installation environment. Use this function as a guide for the life diagnosis.
- Maintenance timers are available for up to three peripheral devices, such as a motor and bearings.

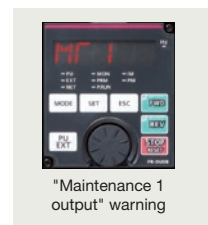

4 Quick Reaction to Troubles

NEW Easy fault diagnosis

- The operating status (output frequency, etc.) immediately before the protection function activates can be stored in the inverter built-in RAM with the trace function. The stored data (trace data) can be copied to a USB memory device or directly imported to a computer, facilitating trouble analysis using the inverter setup software (FR Configurator2).

Trace data stored in the built-in RAM is deleted when the power is turned OFF or the inverter is reset.

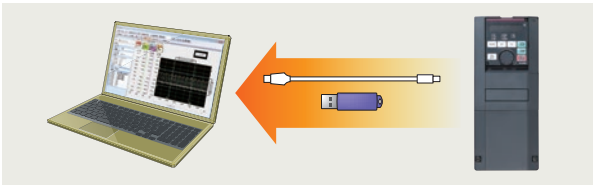

- Clock setting is now available in addition to the already-available cumulative energization time. The time and date at a protective function activation are easily identified. (The clock is reset at power-OFF.) The date and time are also saved with the trace data, making the fault analysis easier. By using the real-time clock function with the optional LCD operation panel (FR-LU08) (when using battery), the time is not reset even when the power supply is turned OFF.

NEW Backup/restore

- The GOT can be used to back up the inverter's parameter settings or the data used in the inverter's PLC function. The backup stored in the GOT can be used to restore the data in the inverter.

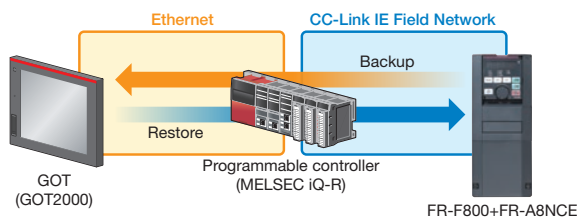

5 Protection of Critical Parameter Settings

Misoperation prevention by setting a password

- Setting a 4-digit password can restrict parameter reading/writing.



6 Renewal Assurance

Compatibility with existing models

- The inverter installation method is the same as that for the FR-F700(P) series, eliminating any concerns over replacement (except for some capacity models). Furthermore, the FR-F700(P) series control circuit terminal blocks can be installed with the use of an option (FR-A8TAT).



- The terminal response adjustment function allows a user to adjust the response speed in accordance with the existing facility. (The response time is shorter for the FR-F800 series.)
- In addition to the FR-F700(P) series' parameter settings, the FR-F500 series parameter settings (to be supported soon) can be easily copied to the FR-F800 series by using the conversion function of FR Configurator2. (Refer to **page 18** for FR Configurator2.)

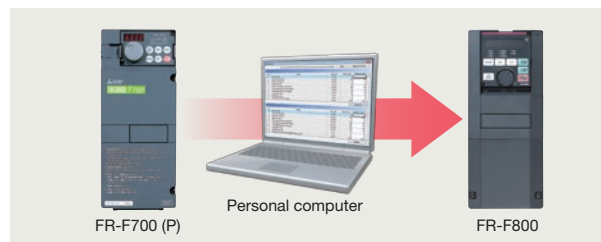

4

COMPATIBILITY WITH THE ENVIRONMENT



1 Suppression of Outgoing Harmonic Current and EMI

•Harmonic current may adversely affect the power supply. To suppress such harmonic current, the power-factor-improving compact AC reactor (FR-HAL) and the DC reactor (FR-HEL) are available. (For the 75 kW or higher inverter, always connect a DC reactor. Select a DC reactor according to the applied motor capacity.)

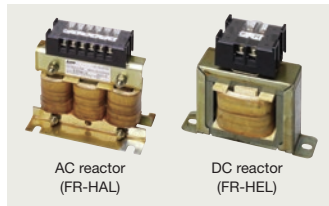

•By attaching the EMC filter connector to the ON or OFF position, the built-in EMC filter can be set enabled/disabled*1*2. When it is enabled, the inverter conforms to the EMC Directive (EN61800-3/2nd Environment Category C3*3) by itself.

*1: Enabling the EMC filter increases leakage current.
 *2: The input side common mode choke, which is built in the 55 kW or lower inverter, is always enabled regardless of the EMC filter ON/OFF connector setting.
 *3: Refer to the EMC Installation Guidelines for the required specifications.

	Capacitive filter	Common mode choke	DC reactor
55 kW or lower	Standard (built-in)	Standard (built-in)	Option (sold separately)
75 kW or higher	Standard (built-in)	Option (sold separately)	Option (sold separately)

•The F800 series 55 kW or lower inverter is equipped with built-in capacitive filters (capacitors) and common mode chokes. By installing the optional DC reactor (FR-HEL), the inverter can conform with Architectural Standard Specifications (Electrical Installation) and the Architectural Standard Specifications (Machinery Installation) supervised by the Ministry of Land, Infrastructure, Transport and Tourism of Japan. (For the F800 series 75 kW or higher inverter, prepare common mode chokes (line noise filters) and a DC reactor.)

•With a high power factor converter (FR-HC2), the inverter is equivalent to a self-excitation three-phase bridge circuit in the "Harmonic Suppression Guidelines for Specific Consumers" in Japan, and realizes the equivalent capacity conversion coefficient $K5=0$. For the 355 kW or higher inverters, the converter is separated. Therefore, installation space can be saved when connecting the FR-HC2.



FR-HC2

2 Protected in Hazardous Environments

Inverters with circuit board coating (IEC60721-3-3:1994 3C2/3S2) and plated conductors are available for improved environmental resistance. ("-60" or "-06" is affixed to the end of the inverter model name.)

3 Global Compatibility

- Complies with UL, cUL, and EC Directives (CE marking), and the Radio Waves Act (South Korea) (KC marking). It is also certified as compliant with the Eurasian Conformity (EAC).
- The inverters are compliant with the EU RoHS Directive (Restriction of the Use of Certain Hazardous Substances in Electrical and Electronic Equipment), friendly to people and to the environment.



For details of the models compliant with global standards, contact your local sales office.

5

EASY SETUP & OPERATION



1 Streamlining the Startup Process

NEW Parameter copy with a USB memory device

A USB host connector (A type), which allows external device connections, has been added. Parameters can be copied to commercial USB memory devices.

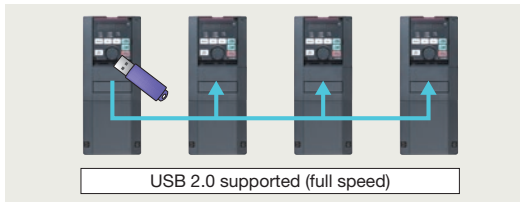

NEW Easy setup with FR Configurator2

- With the sense of unity with other Mitsubishi Electric FA products with common MELSOFT design and operability, the software is easy to use.
- Easy plug-and-play connection is available to the USB terminal equipped as standard.

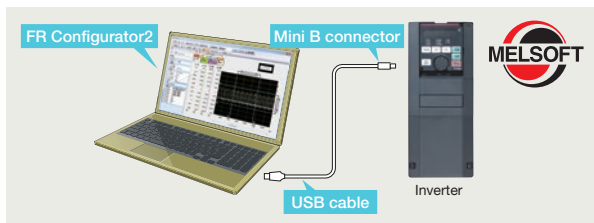

- A free trial version, which contains start-up functions, is available. It can be downloaded at Mitsubishi Electric FA Global Website. (Refer to **page 18** for FR Configurator2.)

NEW Easy wiring to the control circuit

Spring clamp terminals have been adopted for control circuit terminals. Wires can be protected against loosening under vibrations during transportation of the inverter. Ten additional terminals are used as compared to the FR-F700(P) series. Round crimping terminals can also be used by employing a control terminal option (FR-A8TR).

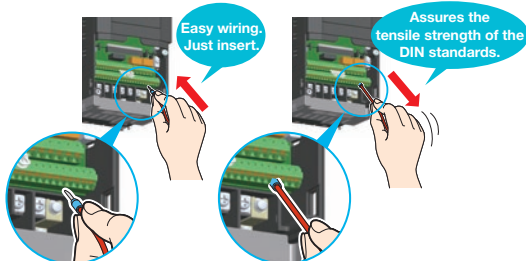

2 Easy-to-follow Display Improves the Operability

NEW Easy operation with GOT

- Automatic communication is possible without specifying any parameter settings simply by connecting to the GOT2000 series.
- The PLC function device monitor can be displayed at the GOT2000 series. Batch control of multiple inverter device monitors is possible with a single GOT unit.
- The sample screen data for the FR-F800 can be found in the screen design software of the GOT2000 series. For the latest version of the screen design software, please contact your local sales office.



NEW Easy-to-follow parameter configuration

With the parameter setting mode selection of the operation panel, the group parameter mode can be selected to provide intuitive and simple parameter settings. (The conventional parameter setting mode is selected by default.)

Major division	Name
E	Environment
F	Acceleration/deceleration
D	Start and frequency commands
H	Protective function
M	Monitor
T	Multiple function input terminals
C	Motor constant
A	Applications
N	Communication
G	Control

Conventional parameter (F700(P)) Pr. 1 2 7

New parameter (F800) Pr. A + 6 + 1 2

Group number Major division Minor division Parameter number

NEW Easy-to-read operation panel

A 5-digit, 12-segment display has been adopted for the operation panel (FR-DU08) for a more natural character display. Furthermore, an optional operation panel (FR-LU08) adopting an LCD panel capable of displaying text and menus is also available.

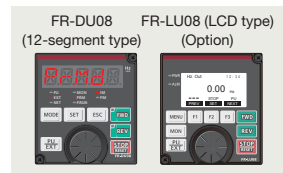

3 To Aid with Maintenance

Reduced wiring check time

Split-type covers are adapted for all capacity models. Maintenance is now easy because all an operator has to do is to remove the cover for the target wiring area.



NEW Maintenance and control of multiple inverters Option

Serial number reading is possible using the optional LCD operation panel (FR-LU08) or the inverter setup software (FR Configurator2). Administration of different inverters has become much more simple.

Wide range of lineup

Inverter

Standard model

FR - F 8 2 0 - 0.75K - 1 -

IP55 compatible model

Symbol	Voltage class	Symbol ^{*)}	Description	Symbol	Type ^{*)}	Communication type	Symbol	Circuit board coating (IEC60721-3-3:1994 3C2/3S2 compatible)	Plated conductor	Symbol	EMC filter
2	200 V class	0.75K to 315K	LD rated inverter capacity (kW)	1	FM	RS-485	None ^{*)}	Without	Without	None ^{*)}	Built-in C3 filter
4	400 V class	00023 to 06830	SLD rated inverter current (A)	2	CA		60	With	Without	C2 ^{*)}	Built-in C2 filter
				E1	FM	Ethernet	06 ^{*)}	With	With	C3 ^{*)}	Built-in C3 filter
				E2	CA						

Symbol	Structure, functionality
0	Standard model
6	IP55 compatible model ^{*)}

Three-phase 200 V class FR-F820-[] ^{*)}	0.75K	1.5K	2.2K	3.7K	5.5K	7.5K	11K	15K	18.5K	22K	30K	37K	45K	55K	75K	90K	110K
	00046	00077	00105	00167	00250	00340	00490	00630	00770	00930	01250	01540	01870	02330	03160	03800	04750
Three-phase 400 V class FR-F840-[] ^{*)} FR-F846-[] ^{*)}	0.75K	1.5K	2.2K	3.7K	5.5K	7.5K	11K	15K	18.5K	22K	30K	37K	45K	55K	75K	90K	110K
	00023	00038	00052	00083	00126	00170	00250	00310	00380	00470	00620	00770	00930	01160	01800	02160	02600
	132K	160K	185K	220K	250K	280K	315K										
	03250	03610	04320	04810	05470	06100	06830										

Separated converter type

FR - F 8 4 2 - 355K - 1 -

Symbol	Voltage class	Symbol	Structure, functionality	Symbol ^{*)}	Description	Symbol	Type ^{*)}	Communication type	Symbol	Circuit board coating (IEC60721-3-3:1994 3C2/3S2 compatible)	Plated conductor
4	400 V class	355K to 560K	Separated converter type	1	LD rated inverter capacity (kW)	1	FM	RS-485	None	Without	Without
		07700 to 12120	SLD rated inverter current (A)	2	CA	2	CA		60	With	Without
				E1	FM	E1	FM	Ethernet	06	With	With
				E2	CA	E2	CA				

Three-phase 400 V class FR-F842-[] ^{*)}	355K	400K	450K	500K	560K
	07700	08660	09620	10940	12120

*1: Applicable for the FR-F846-03610(160K) or lower.

*2: Models can be alternatively indicated with the inverter rated current (SLD rating).

*3: Specification differs by the type as follows.

Type	Monitor output	Initial setting				
		Built-in EMC filter	Control logic	Rated frequency	Pr.19 Base frequency voltage	Pr.570 Multiple rating setting
FM (terminal FM equipped model)	Terminal FM (pulse train output) Terminal AM (analog voltage output (0 to ±10 VDC))	OFF	Sink logic	60 Hz	9999 (same as the power supply voltage)	1 (LD rating)
CA (terminal CA equipped model)	Terminal CA (analog current output (0 to 20 mADC)) Terminal AM (analog voltage output (0 to ±10 VDC))	ON	Source logic	50 Hz	8888 (95% of the power supply voltage)	0 (SLD rating)

*4: Applicable for the standard model only.

*5: Available for the IP55 compatible model, the FR-F820-00340(7.5K) or higher, and the FR-F840-00170(7.5K) or higher.

*6: Applicable for the IP55 compatible model only.

*7: For the FR-F820-03160(75K) or higher, and the FR-F840-01800(75K) or higher, always connect a DC reactor (FR-HEL), which is available as an option. Select a DC reactor according to the applied motor capacity.

*8: Always install the converter unit (FR-CC2). (Not required when a high power factor converter (FR-HC2) is used)

Converter unit

FR - CC2 - H 355K - 60

Symbol	Voltage class	Symbol	Description	Symbol	Circuit board coating (IEC60721-3-3:1994 3C2/3S2 compatible)	Plated conductor
H	400 V class	355K to 630K	Applicable motor capacity (kW)	60	With	Without
				06	With	With

Three-phase 400 V class FR-CC2-H[] (with the built-in DC reactor)	355K	400K	450K	500K	560K	630K
	●	●	●	●	●	●

Premium high-efficiency IPM motor

55 kW or lower **MM-EFS 7 1M 4 -S10**

Symbol	Output	Symbol	Output	Symbol	Output	Symbol	Rated speed ⁹¹	Symbol	Voltage class	Symbol	Dedicated specification	Symbol	Specifications ⁹²	Symbol	Specifications ⁹²
7	0.75 kW	75	7.5 kW	30K	30 kW	1M	1500 r/min	None	200 V	None	Standard model	None	Standard model	None	Standard model
15	1.5 kW	11K	11 kW	37K	37 kW	3	3000 r/min	4	400 V	-S10	Belt drive model	Q	Class B	P1	Outdoor type
22	2.2 kW	15K	15 kW	45K	45 kW										
37	3.7 kW	18K	18.5 kW	55K	55 kW										
55	5.5 kW	22K	22 kW												

⁹¹: The motor can also be used for applications which required the rated speed of 1800 r/min.
⁹²: The outdoor type and class B are semi-standard models.

75 kW or higher **MM-THE4**

- The motor can be used for applications which required the rated speed of 1500 r/min and 1800 r/min.
- For dedicated motors such as the outdoor type, the long-axis type, the flange type, the waterproof outdoor type, and the corrosion proof type, contact your sales representative.

Rated output (kW)		0.75	1.5	2.2	3.7	5.5	7.5	11	15	18.5	22	30	37	45	55	75	90	110	132	160
Motor model		7	15	22	37	55	75	11K	15K	18K	22K	30K	37K	45K	55K	-	-	-	-	-
200 V class	MM-EFS[]1M	●	●	●	●	●	●	●	●	●	●	●	●	●	●	-	-	-	-	-
	MM-EFS[]1M-S10	-	-	-	-	-	-	-	-	-	-	-	-	-	-	-	-	-	-	-
400 V class	MM-EFS[]3	●	●	●	●	●	●	●	●	-	-	-	-	-	-	-	-	-	-	-
	MM-EFS[]1M4	●	●	●	●	●	●	●	●	●	●	●	●	●	●	-	-	-	-	-
400 V class	MM-EFS[]1M4-S10	-	-	-	-	-	-	-	-	-	-	-	-	-	-	-	-	-	-	-
	MM-EFS[]34	●	●	●	●	●	●	●	●	-	-	-	-	-	-	-	-	-	-	-
200 V class	MM-THE4	-	-	-	-	-	-	-	-	-	-	-	-	-	-	●	●	●	●	●
400 V class	MM-THE4	-	-	-	-	-	-	-	-	-	-	-	-	-	-	●	●	●	●	●

- < Note >**
- The IPM motor MM-EFS/MM-THE4 series cannot be driven by the commercial power supply.
 - For IPM motors, the wiring length is 100 m maximum.
 - Only one IPM motor can be connected to an inverter.
 - For belt drive application of the 11 kW or higher MM-EFS series IPM motor with the 1500 r/min specification, use a dedicated belt drive motor. The 11 kW or higher motors with 3000 r/min specification are designed for a direct connection only.

●: Released model -: Not applicable

Inverter by rating

•200 V class

Inverter model FR-F820-[]	SLD (superlight duty)		LD (light duty, initial value)		
	Motor capacity (kW) ⁹¹	Rated current (A)	Motor capacity (kW) ⁹¹	Rated current (A)	
0.75K	00046	0.75	4.6	0.75	4.2
1.5K	00077	1.5	7.7	1.5	7
2.2K	00105	2.2	10.5	2.2	9.6
3.7K	00167	3.7	16.7	3.7	15.2
5.5K	00250	5.5	25	5.5	23
7.5K	00340	7.5	34	7.5	31
11K	00490	11	49	11	45
15K	00630	15	63	15	58
18.5K	00770	18.5	77	18.5	70.5
22K	00930	22	93	22	85
30K	01250	30	125	30	114
37K	01540	37	154	37	140
45K	01870	45	187	45	170
55K	02330	55	233	55	212
75K	03160	75	316	75	288
90K	03800	90/110	380	90	346
110K	04750	132	475	110	432

•400 V class

Inverter model FR-F84[]-[]	SLD (superlight duty)		LD (light duty, initial value)		Inverter model FR-F84[]-[]	SLD (superlight duty)		LD (light duty, initial value)			
	Motor capacity (kW) ⁹¹	Rated current (A)	Motor capacity (kW) ⁹¹	Rated current (A)		Motor capacity (kW) ⁹¹	Rated current (A)	Motor capacity (kW) ⁹¹	Rated current (A)		
0.75K	00023	0.75	2.3	0.75	2.1	90K	02160	110	216	90	180
1.5K	00038	1.5	3.8	1.5	3.5	110K	02600	132	260	110	216
2.2K	00052	2.2	5.2	2.2	4.8	132K	03250	160	325	132	260
3.7K	00083	3.7	8.3	3.7	7.6	160K	03610	185	361	160	325
5.5K	00126	5.5	12.6	5.5	11.5	185K	04320	220	432	185	361
7.5K	00170	7.5	17	7.5	16	220K	04810	250	481	220	432
11K	00250	11	25	11	23	250K	05470	280	547	250	481
15K	00310	15	31	15	29	280K	06100	315	610	280	547
18.5K	00380	18.5	38	18.5	35	315K	06830	355	683	315	610
22K	00470	22	47	22	43	355K	07700	400	770	355	683
30K	00620	30	62	30	57	400K	08660	450	866	400	770
37K	00770	37	77	37	70	450K	09620	500	962	450	866
45K	00930	45	93	45	85	500K	10940	560	1094	500	962
55K	01160	55	116	55	106	560K	12120	630	1212	560	1094
75K	01800	75/90	180	75	144						

•Overload current rating

SLD	110% 60 s, 120% 3 s (inverse-time characteristics) at surrounding air temperature of 40°C
LD	120% 60 s, 150% 3 s (inverse-time characteristics) at surrounding air temperature of 50°C









⁹¹: Indicates the maximum capacity applicable with the Mitsubishi Electric 4-pole standard motor.

For selection of the DC reactor and the converter unit, refer to **page 124**.

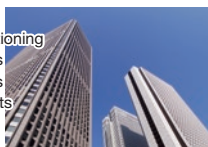
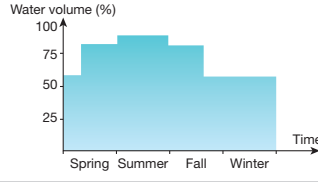
Trial Calculation Example of Energy Saving Effect

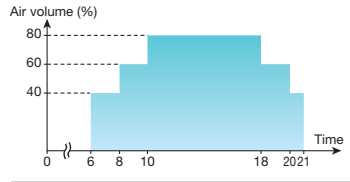
The longer the operating period with medium air volume is, the higher energy saving effect obtained with an inverter.

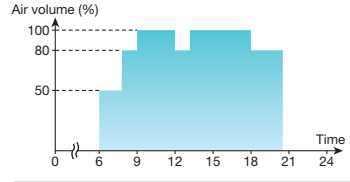
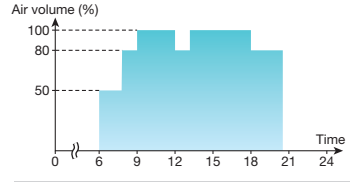
(Conditions: The electricity cost is 14 yen/kWh. The CO₂ emission is 1,000 kWh ≈ 0.55 ton-CO₂)

	Water-cooling pump for a showcase	Air conditioning in a Mitsubishi plant	Air conditioning in a building
Condition	<p>Commercial power supply (valve) + General-purpose motor (SF-PR)</p> <p>Inverter + General-purpose motor (SF-PR)</p> <p>[Units to drive]</p> <ul style="list-style-type: none"> Water-cooling pump 2.2 kW x 2 units 	<p>Inverter + General-purpose motor (SF-JR)</p> <p>Inverter + General-purpose motor (SF-PR)</p> <p>[Units to drive]</p> <ul style="list-style-type: none"> Ventilator 0.75 kW x 3 units, 1.5 kW x 1 unit, 2.2 kW x 3 units Air conditioner 15 kW x 1 unit, 18.5 kW x 1 unit, 30 kW x 2 units 	<p>Inverter + General-purpose motor (SF-PR)</p> <p>Inverter + IPM motor (MM-EFS)</p> <p>[Units to drive]</p> <ul style="list-style-type: none"> Fan for air conditioning 5.5 kW x 10 units, 7.5 kW x 10 units, 3.7 kW x 100 units 
Operation patterns	<p>Water volume (%)</p>  <p>8760 hours/year</p> <ul style="list-style-type: none"> With commercial power supply Approx. 0.04 million kWh Approx. 0.56 million yen With inverter Approx. 0.02 million kWh Approx. 0.29 million yen 	<p>Air volume (%)</p>  <p>5475 hours/year</p> <ul style="list-style-type: none"> With SF-JR Approx. 0.25 million kWh Approx. 3.44 million yen With SF-PR Approx. 0.23 million kWh Approx. 3.20 million yen  	<p>Air volume (%)</p>  <p>5110 hours/year</p> <ul style="list-style-type: none"> With SF-PR Approx. 2.23 million kWh Approx. 31.27 million yen With IPM motor Approx. 2.10 million kWh Approx. 29.43 million yen  
Annual energy saving effect	<p>(Annual) energy saving effect produced by replacing to IPM motors driven with inverters</p> <p>(differences in the amount and cost) Approx. 0.02 million kWh</p> <p>Approx. 0.27 million yen</p> <p>Annual CO₂ emission reduction Approx. 0.02 million kWh 10.7 tons</p>	<p>(differences in the amount and cost) Approx. 0.017 million kWh</p> <p>Approx. 0.24 million yen</p> <p>Annual CO₂ emission reduction Approx. 0.017 million kWh 9.5 tons</p>	<p>(differences in the amount and cost) Approx. 0.131 million kWh</p> <p>Approx. 1.84 million yen</p> <p>Annual CO₂ emission reduction Approx. 0.131 million kWh 72.3 tons</p>

Your best assistant - Mitsubishi Electric inverter software

IPM energy savings simulation file

The IPM energy savings simulation file calculates the energy saving effect and CO₂ reduction rate achieved by replacing commercial power supply (damper/valve control) operation with IPM motor operation by inverter. This file requires inputs such as the capacity, quantity, air volume, and operating time of motors.



FR Configurator2 (SW1DND-FRC2) Option

Support tool for the inverter operations from start-up to maintenance. Refer to page 18 for details.

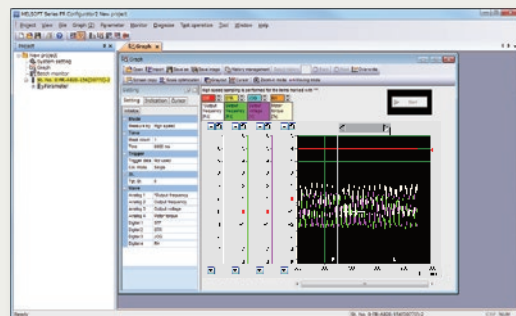

BEST SUITED FOR EVERY MACHINE

Cooling tower

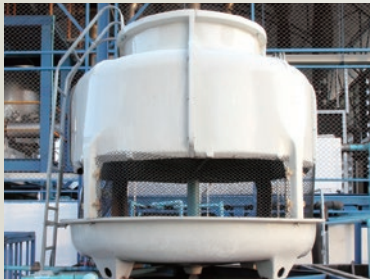

PID control

A sensor monitors a cooling water temperature, which enables the operation corresponding to the target temperature. The system cost can be reduced because no external PID controller is required.

Electronic bypass function

The inverter contains complicated sequence circuits for switching between the commercial power supply operation and inverter operation. The operation can be automatically switched over to the commercial power supply operation if a fault occurs in the inverter.

Building water pumps



Multi-pump function NEW

By controlling the pumps connected in parallel (up to four pumps) by the PID control by one inverter, water volume, etc. can be adjusted.

PID pre-charge function NEW

The system avoids sudden acceleration at the pump start and prevents the pump from being damaged by water hammer.

Load characteristics measurement function NEW

The system quickly detects faults such as adhesion of foreign matter to the impellers, etc.

Air conditioning of buildings



PM motor control

Driving a PM motor, which is more efficient than an induction motor, achieves more energy savings.

Automatic restart after instantaneous power failure / flying start function

When the power is restored after an instantaneous power failure, the operation can be restarted from the motor coasting speed. Even if a flying start changes the rotation direction, the operation can be smoothly started.

PID control PID forward/reverse action switchover

The forward/reverse rotation under PID control can be switched by turning ON/OFF the signal input, which allows easy switching between the heating and cooling temperature controls.

BACnet[®]MS/TP NEW

BACnet[®]MS/TP is a suitable network for use with air conditioning controls. This makes it possible to achieve efficient air conditioning controls with all-in-one management of the air conditioning in the entire building.

Compressor



Advanced optimum excitation control NEW

While saving energy just as with the conventional Optimum excitation control, the new Advanced optimum excitation control provides a large starting torque, which allows for both a large starting torque and energy saving operation.

High-speed operation NEW

[Maximum output frequency]

- V/F control 590 Hz
- Advanced magnetic flux vector control 400 Hz

CONTRIBUTION TO FACTORY AUTOMATION

The PLC function will help you to provide the control sequence best suited for the machine specifications.

2

Example Applications, PLC Functions, FR Configurator2

1 Inverter operation sequence customized for the machine

- A set of operations (operation at different signal inputs, signal and monitor outputs at different inverter status, etc.) can be freely programmed in accordance with the machine specifications. For example, a shutter opening/closing can be performed based on a signal from a sensor, or based on the opening/closing times. Control programs can be created in sequence ladders using the inverter setup software (FR Configurator2).

2 Realizes the decentralized control

- The control of the whole system is decentralized to inverters that manage their subordinating devices individually.
- A group of dedicated sequence programs is created and saved in each inverter. The master controller no longer has to process all the sequence programs, and the decentralized system accepts program changes more flexibly.

3 Automatic operation in accordance with the time

- With the real-time clock, automatic operation can be performed at certain times (when the optional LCD operation panel (FR-LU08) is used).

4 Useful functions

- **User parameter**
Up to 50 parameters, which are linked with the data registers, can be saved. The variables (data registers) used in the PLC function can be saved as inverter parameters. Furthermore, parameter settings can be saved in the EEPROM of inverter. When results of calculation using the PLC function are saved in the parameters, the data can be retained after the power is turned OFF.
- **User initiated fault**
Inverter output can be shut off under conditions other than those of the existing protective functions. Up to five specific fault-initiating conditions can be set to activate a protective function and shut off the inverter output.
- **Monitored item for the user**
Special register values can be displayed for monitoring on the operation panel. Arbitrary data designated by the user such as results of calculation using the PLC function can be displayed.
- **Inverter parameter read/write**
Parameter settings can be changed using sequence programs. The acceleration/deceleration patterns can also be set with sequence programs to be changed at certain operation statuses. You can choose RAM or EEPROM to save the parameter settings. When the settings are changed frequently, choose RAM.
- **PID function**
Two different loops of PID inverter operations can be pre-set, and those can be controlled using sequence programs.
- **Inverter operation lock**
The inverter operation can be restricted for the command sources other than the sequence programs.

PLC function

Item	Description
I/O	
General-purpose I/O	Sequence programs enable I/O signal transmission to/from the inverter and its plug-in options.
Analog I/O	Sequence programs enable reading of analog input values or analog output transmission by the inverter, and analog output transmission to the plug-in options.
Pulse train I/O	Sequence programs enable pulse train inputs (to terminal JOG) and pulse train outputs (from terminal F/C(FM)).
Inverter parameter read/write	Sequence programs enable inverter parameter write/read.
User parameter	Fifty user parameters (Pr.1150 to Pr.1199) are available and are linked with the data registers D206 to D255, which accept direct access by sequence programs.
CC-Link	A plug-in option (FR-A8NC) enables handling of remote registers as arbitrary data in the sequence programs.
Special function	
PID operation	Inverter's PID operations can be set (up to two loops).
User initiated fault	Up to five fault-initiating conditions can be set to activate a protective function.
Fault clear	The protective function occurring in the inverter can be reset.
Inverter operation lock	Inverters can start up while the PLC function is running.
Monitored item for the user	Desired data is displayable on the operation panel.

Application Example

Fountain height control



Controlling the water pressure (rotations per minute) allows the fountain height to be changed. PLC programs allow various operation patterns to create a variety of effects. The time-based automatic operation is possible by using the sequence programs in combination with the real-time clock function (when using an optional LCD operation panel (FR-LU08)).

Inverter parameter read/write

Inverter parameters can be changed through the sequence programs. The height and duration of the spouting water can be set.

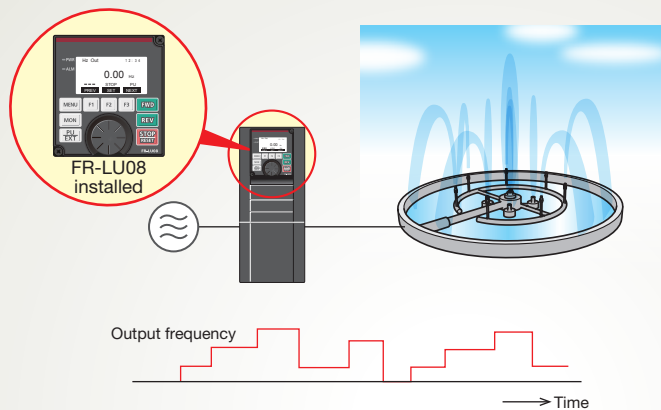

Fan control



Signals sent via the enclosure (relay panel, etc.) such as input magnetic contactor signals, watt hour meter signals, and sensor signals can be read directly into the inverter and controlled. A fan can be controlled in accordance with the conditions without using relays, etc. Furthermore, by using an external 24 VDC power source for the control power supply, input machine signals can be turned ON and OFF regardless of whether there is an input power source. And by employing an external 24 VDC power supply for the control power, input machine signals can be turned ON and OFF, regardless of the existence of a main circuit power supply.

CC-Link

A plug-in option (FR-A8NC) enables handling of remote registers as arbitrary data in the sequence programs. A variety of equipment inside the factory can be centrally controlled with a CC-Link Network.

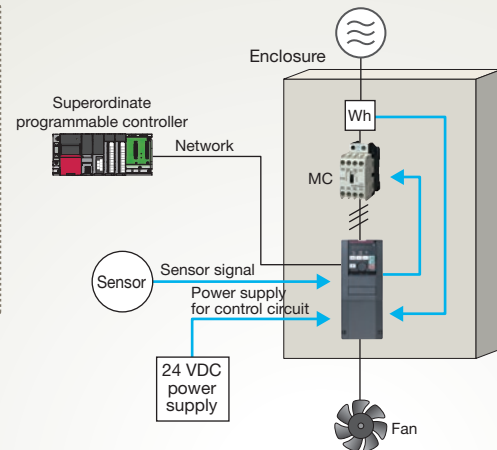

DELIVERING A COMFORTABLE INVERTER

From inverter startup to maintenance, this versatile software allows the user to specify settings easily at the computer.



[Compatible operating systems]

Windows® 10 (Home, Pro, Enterprise, IoT Enterprise (64-bit)), Windows® 8.1, Windows® 7 SP1 or later (Professional, Enterprise)

2

Example Applications, PLC Functions, FR Configurator2

Easy connection with a USB cable

A USB connector (Mini-B connector) is provided as standard. Easy connection to the computer without the need for a converter.

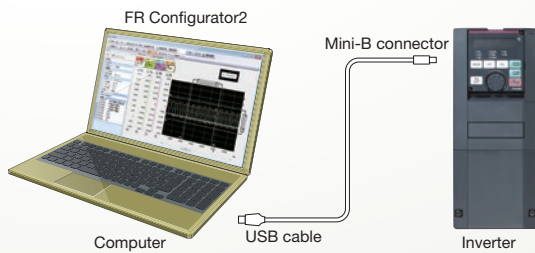

Intuitive user interface

Connected inverters are displayed in tree view format. Windows for each function can be accessed by changing the tab for maximum efficiency.

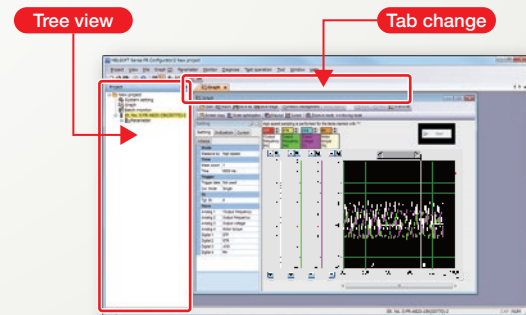

Work can be carried out away from the equipment using a USB memory device

By loading trace data and parameter settings copied to a USB memory device into FR Configurator2, analysis and adjustments can be carried out with ease away from the equipment.

Sequence control (Developer function)

The Developer function is used for creating sequence programs and writing them to the inverter to enable the use of the PLC function of the inverter.

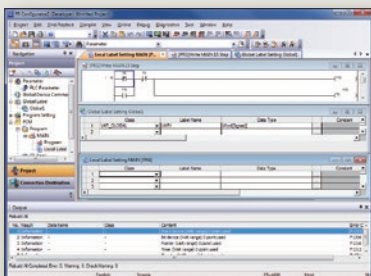

Free trial version Supported

The function with the marking above is available in the free trial version (usable free of charge with limited functions). It can be downloaded at Mitsubishi Electric FA Global Website.

Function	Free trial version	Function	Free trial version
Parameter list	○	Developer	×
Diagnosis	○	USB memory parameter copy file edit	×
AI fault diagnosis	×	Ethernet parameter setting	○
Graph	×	iQSS backup file conversion	○
Batch monitor	×	Firmware Update Tool	○
Test operation	○	Help	○
I/O terminal monitor	×		
Convert	○		

A full functional trial version, which has the same functionality as the release version, is also offered for a limited period of 30 days.

OPERATING ENVIRONMENT



1 Efficient startup settings

System settings

Free trial version Supported

This sets the method used to connect the inverters and the computer. Automatic recognition of connected inverters can also be set. The station number, model, capacity, and plug-in options of the connected inverters can also be set manually.

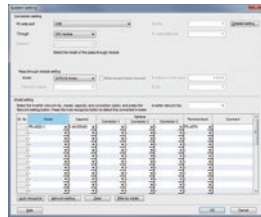

Test operation

Free trial version Supported

Operating commands, frequency settings, and the operating mode can be set for the selected inverter.



Conversion function

Free trial version Supported

Parameters can be set with the parameter auto conversion function when renewing from the FR-F700(P) series or FR-F500 series.

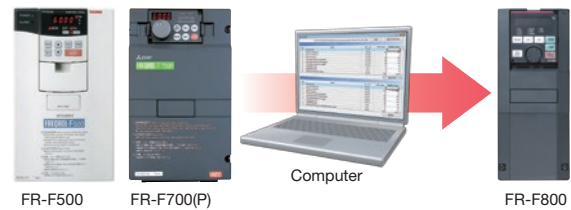

Parameter settings for Ethernet communication (FR-F800-E only)

The network number, station number, host name, IP address, and subnet mask can be set.

At the initial startup of FR Configurator2, inverters connected to the same network are detected automatically.



2 Perform pre-operation adjustments and checks during operation with ease

Parameter list

Free trial version Supported

Parameters for selected station numbers can be displayed and changed.

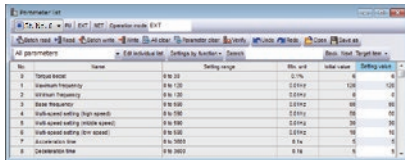

I/O signals can be assigned using settings by function.

Offline auto tuning

Tuning is performed in wizard format after specifying necessary parameter settings.

Batch monitor function

Multiple inverter monitor items can be monitored simultaneously.

With a terminal monitor, the ON/OFF status can be monitored.

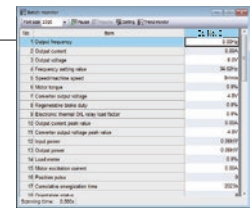

USB memory parameter copy file edit

Parameter settings (USB memory device parameter copy file) read from the inverter to a USB memory device can be edited. With the iQSS backup file conversion function, the files in the backup/restore format generated by the GOT can be converted and edited.



3 Easy-to-follow platform facilitates easy maintenance

Diagnosis (fault history)

Free trial version Supported

Inverter fault history can be read and displayed together with the alarm occurrence time. Activating faults can be displayed, and inverters can also be reset.



Graph function

Inverter data can be sampled and displayed in a graphical format. Trace data can also be read and displayed in a graph.

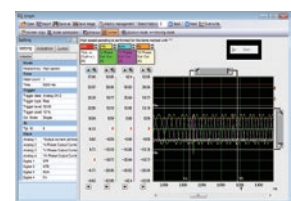

Help

Free trial version Supported

Displays the content of inverter and software Instruction Manuals.

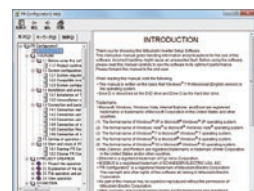

Life diagnosis

Free trial version Supported

Life information read from the inverter is displayed. An alert icon is shown in the parts life alarm field for the parts recommended for replacement. The diagnosis result output function is available to output the data of diagnosis results to a file.

Example Connection

● Connection example for standard models



Three-phase AC power supply
Must be within the permissible power supply specifications of the inverter. (Refer to page 21.)



Molded case circuit breaker (MCCB) or earth leakage current breaker (ELB), fuse
Must be selected carefully since an inrush current flows in the inverter at power ON. (Refer to page 111.)



Magnetic contactor (MC)
Install this to ensure safety. Do not use this to start and stop the inverter. Doing so will shorten the life of the inverter. (Refer to page 112.)

AC reactor (FR-HAL)
(Refer to page 95.)

DC reactor (FR-HEL)
(Refer to page 96.)



Line noise filter (FR-BLF)
The FR-F820-02330(55K) or lower and the FR-F840-01160(55K) or lower are equipped with the common mode choke. (Refer to page 97.)

For the FR-F820-03160(75K) or higher, the FR-F840-01800(75K) or higher, always connect a DC reactor. (The IP55 compatible model and the converter unit (FR-CC2) have a built-in DC reactor.)



USB connector

USB host (A connector)
Communication status LED indicator (USB host)



USB memory device
(Refer to page 51.)

USB device (Mini B connector)



Personal computer (FR Configurator2)
(Refer to page 18.)

3

Example Connection

P/+ P1 R/L1 S/L2T/L3 P/+ N/-

Earth (Ground)

IM connection

PM connection



EMC filter (ferrite core) (FR-BSF01, FR-BLF)
(Refer to page 97.)

Contactor
(Example: No-fuse switch (DSN type))
Connect this for an application where a PM motor is driven by the load even while the inverter power is OFF. Do not open or close the contactor while the inverter is running (outputting). (Refer to page 118.)

Induction motor
(Refer to page 124.)

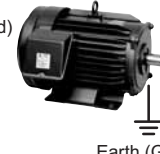

Earth (Ground)

IPM motor (MM-EFS, MM-THE4)
(Refer to page 129.)

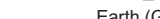

Earth (Ground)



High power factor converter (FR-HC2)
(Refer to page 107.)



Multifunction regeneration converter (FR-XC)
(Refer to page 101.)
Power regeneration converter (MT-RC*2)
(Refer to page 106.)



Brake unit (FR-BU2)
(Refer to page 98.)
Resistor unit (FR-BR*1, MT-BR5*2)
(Refer to page 98.)

■ : Install them as required.

*1 Compatible with the FR-F820-02330(55K) or lower and the FR-F840-01160(55K) or lower.
*2 Compatible with the FR-F820-03160(75K) or higher and the FR-F840-01800(75K) or higher.

Standard Specifications

● Rating (standard model)

◆ 200 V class

Model FR-F820-[-E]		00046	00077	00105	00167	00250	00340	00490	00630	00770	00930	01250	01540	01870	02330	03160	03800	04750		
		0.75K	1.5K	2.2K	3.7K	5.5K	7.5K	11K	15K	18.5K	22K	30K	37K	45K	55K	75K	90K	110K		
Applicable motor capacity (kW) *1	SLD	0.75	1.5	2.2	3.7	5.5	7.5	11	15	18.5	22	30	37	45	55	75	90/110	132		
	LD	0.75	1.5	2.2	3.7	5.5	7.5	11	15	18.5	22	30	37	45	55	75	90	110		
Output	Rated capacity (kVA) *2	SLD	1.8	2.9	4	6.4	10	13	19	24	29	35	48	59	71	89	120	145	181	
		LD	1.6	2.7	3.7	5.8	8.8	12	17	22	27	32	43	53	65	81	110	132	165	
	Rated current (A)	SLD	4.6	7.7	10.5	16.7	25	34	49	63	77	93	125	154	187	233	316	380	475	
		LD	4.2	7	9.6	15.2	23	31	45	58	70.5	85	114	140	170	212	288	346	432	
Overload current rating *3	SLD	110% 60 s, 120% 3 s (inverse-time characteristics) at surrounding air temperature of 40°C																		
	LD	120% 60 s, 150% 3 s (inverse-time characteristics) at surrounding air temperature of 50°C																		
Rated voltage *4		Three-phase 200 to 240 V																		
Rated input AC voltage/frequency		Three-phase 200 to 240 V 50 Hz/60 Hz																		
Permissible AC voltage fluctuation		170 to 264 V 50 Hz/60 Hz																		
Permissible frequency fluctuation		±5%																		
Power supply	Rated input current (A) *5	Without DC reactor	SLD	5.3	8.9	13.2	19.7	31.3	45.1	62.8	80.6	96.7	115	151	185	221	269	-	-	-
			LD	5	8.3	12.2	18.3	28.5	41.6	58.2	74.8	90.9	106	139	178	207	255	-	-	-
	With DC reactor	SLD	4.6	7.7	10.5	16.7	25	34	49	63	77	93	125	154	187	233	316	380	475	
		LD	4.2	7	9.6	15.2	23	31	45	58	71	85	114	140	170	212	288	346	432	
	Power supply capacity (kVA) *6	Without DC reactor	SLD	2	3.4	5	7.5	12	17	24	31	37	44	58	70	84	103	-	-	-
			LD	1.9	3.2	4.7	7	11	16	22	29	35	41	53	68	79	97	-	-	-
With DC reactor		SLD	1.8	2.9	4	6.4	10	13	19	24	29	35	48	59	71	89	120	145	181	
	LD	1.6	2.7	3.7	5.8	8.8	12	17	22	27	32	43	53	65	81	110	132	165		
Protective structure (IEC 60529) *7		Enclose type (IP20)											Open type (IP00)							
Cooling system		Natural			Forced air															
Approx. mass (kg)		1.9	2.1	3.0	3.0	3.0	6.3	6.3	8.3	15	15	15	22	42	42	54	74	74		

- *1 The applicable motor capacity indicated is the maximum capacity applicable for use of the Mitsubishi Electric 4-pole standard motor.
- *2 The rated output capacity indicated assumes that the output voltage is 220 V for 200 V class.
- *3 The % value of the overload current rating indicated is the ratio of the overload current to the inverter's rated output current. For repeated duty, allow time for the inverter and motor to return to or below the temperatures under 100% load.
- *4 The maximum output voltage does not exceed the power supply voltage. The maximum output voltage can be changed within the setting range. However, the maximum point of the voltage waveform at the inverter output side is the power supply voltage multiplied by about $\sqrt{2}$.
- *5 The rated input current indicates a value at a rated output voltage. The impedance at the power supply side (including those of the input reactor and cables) affects the rated input current.
- *6 The power supply capacity is the value when at the rated output current. It varies by the impedance at the power supply side (including those of the input reactor and cables).
- *7 FR-DU08: IP40 (except for the PU connector section)

◆ 400 V class

Model FR-F840-[] (-E)		00023	00038	00052	00083	00126	00170	00250	00310	00380	00470	00620	00770	00930	01160	01800	02160	02600	03250	03610	04320	04810	05470	06100	06830		
		0.75K	1.5K	2.2K	3.7K	5.5K	7.5K	11K	15K	18.5K	22K	30K	37K	45K	55K	75K	90K	110K	132K	160K	185K	220K	250K	280K	315K		
Applicable motor capacity (kW) *1	SLD	0.75	1.5	2.2	3.7	5.5	7.5	11	15	18.5	22	30	37	45	55	75/90	110	132	160	185	220	250	280	315	355		
	LD	0.75	1.5	2.2	3.7	5.5	7.5	11	15	18.5	22	30	37	45	55	75	90	110	132	160	185	220	250	280	315		
Output	Rated capacity (kVA) *2	SLD	1.8	2.9	4	6.3	10	13	19	24	29	36	47	59	71	88	137	165	198	248	275	329	367	417	465	521	
		LD	1.6	2.7	3.7	5.8	8.8	12	18	22	27	33	43	53	65	81	110	137	165	198	248	275	329	367	417	465	
	Rated current (A)	SLD	2.3	3.8	5.2	8.3	12.6	17	25	31	38	47	62	77	93	116	180	216	260	325	361	432	481	547	610	683	
		LD	2.1	3.5	4.8	7.6	11.5	16	23	29	35	43	57	70	85	106	144	180	216	260	325	361	432	481	547	610	
Overload current rating *3	SLD	110% 60 s, 120% 3 s (inverse-time characteristics) at surrounding air temperature of 40°C																									
	LD	120% 60 s, 150% 3 s (inverse-time characteristics) at surrounding air temperature of 50°C																									
Rated voltage *4		Three-phase 380 to 500 V																									
Rated input AC voltage/frequency		Three-phase 380 to 500 V 50 Hz/60 Hz *8																									
Permissible AC voltage fluctuation		323 to 550 V 50 Hz/60 Hz																									
Permissible frequency fluctuation		±5%																									
Power supply	Rated input current (A) *5	Without DC reactor	SLD	3.2	5.4	7.8	10.9	16.4	22.5	31.7	40.3	48.2	58.4	76.8	97.6	115	141	-	-	-	-	-	-	-	-	-	
			LD	3	4.9	7.3	10.1	15.1	22.3	31	38.2	44.9	53.9	75.1	89.7	106	130	-	-	-	-	-	-	-	-	-	-
		With DC reactor	SLD	2.3	3.8	5.2	8.3	12.6	17	25	31	38	47	62	77	93	116	180	216	260	325	361	432	481	547	610	683
			LD	2.1	3.5	4.8	7.6	11.5	16	23	29	35	43	57	70	85	106	144	180	216	260	325	361	432	481	547	610
	Power supply capacity (kVA) *6	Without DC reactor	SLD	2.5	4.1	5.9	8.3	12	17	24	31	37	44	59	74	88	107	-	-	-	-	-	-	-	-	-	-
			LD	2.3	3.7	5.5	7.7	12	17	24	29	34	41	57	68	81	99	-	-	-	-	-	-	-	-	-	-
		With DC reactor	SLD	1.8	2.9	4	6.3	10	13	19	24	29	36	47	59	71	88	137	165	198	248	275	329	367	417	465	521
			LD	1.6	2.7	3.7	5.8	8.8	12	18	22	27	33	43	53	65	81	110	137	165	198	248	275	329	367	417	465
Protective structure (IEC 60529) *7		Enclose type (IP20)												Open type (IP00)													
Cooling system		Natural						Forced air																			
Approx. mass (kg)		2.7	2.7	2.7	3.1	3.1	6.3	6.3	8.3	8.3	15	15	23	41	41	43	52	55	71	78	117	117	166	166	166		

- *1 The applicable motor capacity indicated is the maximum capacity applicable for use of the Mitsubishi Electric 4-pole standard motor.
- *2 The rated output capacity indicated assumes that the output voltage is 440 V for 400 V class.
- *3 The % value of the overload current rating indicated is the ratio of the overload current to the inverter's rated output current. For repeated duty, allow time for the inverter and motor to return to or below the temperatures under 100% load.
- *4 The maximum output voltage does not exceed the power supply voltage. The maximum output voltage can be changed within the setting range. However, the maximum point of the voltage waveform at the inverter output side is the power supply voltage multiplied by about $\sqrt{2}$.
- *5 The rated input current indicates a value at a rated output voltage. The impedance at the power supply side (including those of the input reactor and cables) affects the rated input current.
- *6 The power supply capacity is the value when at the rated output current. It varies by the impedance at the power supply side (including those of the input reactor and cables).
- *7 FR-DU08: IP40 (except for the PU connector section)
- *8 For the power voltage exceeding 480 V, set **Pr.977 Input voltage mode selection**.

● Rating (separated converter type)

◆ 400 V class

• Inverter

Model FR-F842-[-E]		07700	08660	09620	10940	12120
		355K	400K	450K	500K	560K
Applicable motor capacity (kW) *1	SLD	400	450	500	560	630
	LD	355	400	450	500	560
Rated capacity (kVA) *2	SLD	587	660	733	834	924
	LD	521	587	660	733	834
Rated current (A)	SLD	770	866	962	1094	1212
	LD	683	770	866	962	1094
Overload current rating *3	SLD	110% 60 s, 120% 3 s (inverse-time characteristics) at surrounding air temperature of 40°C				
	LD	120% 60 s, 150% 3 s (inverse-time characteristics) at surrounding air temperature of 50°C				
Rated voltage *4		Three-phase 380 to 500 V				
Regenerative braking torque *5 (When the converter unit (FR-CC2) is used)	Maximum brake torque	10% torque/continuous				
DC power supply voltage		430 to 780 VDC				
Control power supply auxiliary input		Single phase 380 to 500 V 50 Hz/60 Hz *7				
Permissible control power supply auxiliary input fluctuation		Frequency ±5%, voltage ±10%				
Protective structure (IEC 60529) *6		Open type (IP00)				
Cooling system		Forced air				
Approx. mass (kg)		163	163	243	243	243

*1 The applicable motor capacity indicated is the maximum capacity applicable for use of the Mitsubishi Electric 4-pole standard motor.

*2 The rated output capacity indicated assumes that the output voltage is 440 V.

*3 The % value of the overload current rating indicated is the ratio of the overload current to the inverter's rated output current. For repeated duty, allow time for the inverter and motor to return to or below the temperatures under 100% load.

*4 The maximum output voltage does not exceed the power supply voltage. The maximum output voltage can be changed within the setting range. However, the maximum point of the voltage waveform at the inverter output side is the power supply voltage multiplied by about $\sqrt{2}$.

*5 LD rating reference value

*6 FR-DU08: IP40 (except for the PU connector section)

*7 For the power voltage exceeding 480 V, set **Pr.977 Input voltage mode selection**.

• Converter unit (FR-CC2)

Model FR-CC2-H[]		355K	400K	450K	500K	560K	630K
Applicable motor capacity (kW)		355	400	450	500	560	630
Output	Overload current rating *1	200% 60 s, 250% 3 s			150% 60 s, 200% 3 s	120% 60 s, 150% 3 s	110% 60 s, 120% 3 s
	Rated voltage *2	430 to 780 VDC *4					
Power supply	Rated input AC voltage/frequency	Three-phase 380 to 500 V 50 Hz/60 Hz					
	Permissible AC voltage fluctuation	Three-phase 323 to 550 V 50 Hz/60 Hz					
	Permissible frequency fluctuation	±5%					
	Rated input current (A)	683	770	866	962	1094	1212
Power supply capacity (kVA) *3		521	587	660	733	833	924
Protective structure (IEC 60529)		Open type (IP00)					
Cooling system		Forced air					
DC reactor		Built-in					
Approx. mass (kg)		213	282	285	288	293	294

*1 The % value of the overload current rating indicated is the ratio of the overload current to the inverter's rated output current. For repeated duty, allow time for the converter unit and the inverter to return to or below the temperatures under 100% load.

*2 The converter unit output voltage varies according to the input power supply voltage and the load. The maximum point of the voltage waveform at the converter unit output side is approximately the power supply voltage multiplied by $\sqrt{2}$.

*3 The power supply capacity is the value when at the rated output current. It varies by the impedance at the power supply side (including those of the input reactor and cables).

*4 The permissible voltage imbalance ratio is 3% or less. (Imbalance ratio = (highest voltage between lines - average voltage between three lines) / average voltage between three lines × 100)

● Rating (IP55 compatible model)

◆ 400 V class

Model FR-F846-□		00023	00038	00052	00083	00126	00170	00250	00310	00380	00470	00620	00770	00930	01160	01800	02160	02600	03250	03610	
		0.75K	1.5K	2.2K	3.7K	5.5K	7.5K	11K	15K	18.5K	22K	30K	37K	45K	55K	75K	90K	110K	132K	160K	
Applicable motor capacity (kW) *1		0.75	1.5	2.2	3.7	5.5	7.5	11	15	18.5	22	30	37	45	55	75	90	110	132	160	
Output	Rated capacity (kVA) *2	1.6	2.7	3.7	5.8	8.8	12	18	22	27	33	43	53	65	81	110	137	165	198	248	
	Rated current (A)	2.1	3.5	4.8	7.6	11.5	16	23	29	35	43	57	70	85	106	144	180	216	260	325	
Overload current rating *3		120% 60 s, 150% 3 s (inverse-time characteristics) at surrounding air temperature of 40°C																			
Rated voltage *4		Three-phase 380 to 500 V																			
Power supply	Rated input AC voltage/frequency	Three-phase 380 to 500 V 50 Hz/60 Hz *7																			
	Permissible AC voltage fluctuation	323 to 550 V 50 Hz/60 Hz																			
	Permissible frequency fluctuation	±5%																			
	Rated input current (A) *5	2.1	3.5	4.8	7.6	11.5	16	23	29	35	43	57	70	85	106	144	180	216	260	325	
Power supply capacity (kVA) *6		1.6	2.7	3.7	5.8	9	12	18	22	27	33	43	53	65	81	110	137	165	198	248	
Protective structure	IEC 60529	Dust- and water-proof type (IP55) *9																			
	UL50	UL Type12 *8																			
Cooling system		Self cooling + internal fan							Forced-air-cooling + internal fan												
Approx. mass (kg)		15	15	15	15	16	17	26	26	27	27	59	60	63	64	147	150	153	189	193	

- *1 The applicable motor capacity indicated is the maximum capacity applicable for use of the Mitsubishi Electric 4-pole standard motor.
- *2 The rated output capacity indicated assumes that the output voltage is 440 V.
- *3 The % value of the overload current rating indicated is the ratio of the overload current to the inverter's rated output current. For repeated duty, allow time for the inverter and motor to return to or below the temperatures under 100% load.
- *4 The maximum output voltage does not exceed the power supply voltage. The maximum output voltage can be changed within the setting range. However, the maximum point of the voltage waveform at the inverter output side is the power supply voltage multiplied by about $\sqrt{2}$.
- *5 The rated input current indicates a value at a rated output voltage. The impedance at the power supply side (including those of the input reactor and cables) affects the rated input current.
- *6 The power supply capacity is the value when at the rated output current. It varies by the impedance at the power supply side (including those of the input reactor and cables).
- *7 For the power voltage exceeding 480 V, set **Pr.977 Input voltage mode selection**.
- *8 UL Type 12 Enclosure-Suitable for Installation in a Compartment Handling Conditioned Air (Plenum)
- *9 For compliance with IP55, remove the protective bushes and install the recommended cable glands.

● Common specifications

Control specifications	Control method		Soft-PWM control, high carrier frequency PWM control (selectable among V/F control (Optimum excitation control), Advanced magnetic flux vector control (Advanced optimum excitation control) and PM motor control)
	Output frequency range		0.2 to 590 Hz (The upper-limit frequency is 400 Hz under Advanced magnetic flux vector control, and PM motor control.)
	Frequency setting resolution	Analog input	0.015 Hz/60 Hz (terminal 2, 4: 0 to 10 V/12 bits) 0.03 Hz/60 Hz (0 to 5 V/11 bits or 0 to 20 mA/approx. 11 bits for terminals 2 and 4, 0 to ±10 V/12 bits for terminal 1) 0.06 Hz/60 Hz (0 to ±5 V/11 bits for terminal 1)
		Digital input	0.01 Hz
	Frequency accuracy	Analog input	Within ±0.2% of the max. output frequency (25°C ±10°C)
		Digital input	Within 0.01% of the set output frequency
	Voltage/frequency characteristics		Base frequency can be set from 0 to 590 Hz. Constant-torque/variable-torque pattern or adjustable 5 points V/F can be selected.
	Starting torque	Induction motor	120% 0.5 Hz (Advanced magnetic flux vector control)
		IPM motor	50%
	Torque boost		Manual torque boost
Acceleration/deceleration time setting		0 to 3600 s (acceleration and deceleration can be set individually), linear or S-pattern acceleration/deceleration mode, backlash countermeasures acceleration/deceleration can be selected.	
DC injection brake (induction motor)		Operation frequency (0 to 120 Hz), operation time (0 to 10 s), operation voltage (0 to 30%) variable	
Stall prevention operation level		Activation range of stall prevention operation (SLD rating: 0 to 120%, LD rating: 0 to 150%). Whether to use the stall prevention or not can be selected. (V/F control, Advanced magnetic flux vector control)	
Operation specifications	Frequency setting signal	Analog input	Terminals 2 and 4: 0 to 10 V, 0 to 5 V, 4 to 20 mA (0 to 20 mA) are available. Terminal 1: -10 to +10 V, -5 to 5 V are available.
		Digital input	Input using the setting dial of the operation panel or the parameter unit Four-digit BCD or 16-bit binary (when used with option FR-A8AX)
	Start signal		Forward and reverse rotation or start signal automatic self-holding input (3-wire input) can be selected.
	Input signals (twelve terminals)		Low-speed operation command, Middle-speed operation command, High-speed operation command, Second function selection, Terminal 4 input selection, Jog operation selection, Output stop, Start self-holding selection, Forward rotation command, Reverse rotation command, Inverter reset The input signal can be changed using Pr.178 to Pr.189 (input terminal function selection) .
	Pulse train input		100 k pulses/s
	Operational functions		Maximum and minimum frequency settings, multi-speed operation, acceleration/deceleration pattern, thermal protection, DC injection brake, starting frequency, JOG operation, output stop (MRS), stall prevention, regeneration avoidance, increased magnetic excitation deceleration, DC feeding*1, frequency jump, rotation display, automatic restart after instantaneous power failure, electronic bypass sequence, remote setting, retry function, carrier frequency selection, fast-response current limit, forward/reverse rotation prevention, operation mode selection, slip compensation, speed smoothing control, traverse, auto tuning, applied motor selection, RS-485 communication, Ethernet communication*6, PID control, PID pre-charge function, cooling fan operation selection, stop selection (deceleration stop/coasting), power-failure deceleration stop function, PLC function, life diagnosis, maintenance timer, current average monitor, multiple rating, test run, 24 V power supply input for control circuit, safety stop function, self power management, BACnet communication, PID gain tuning, cleaning, load characteristics storage, emergency drive*1
	Output signal	Open collector output (five terminals)	Inverter running, Up to frequency, Instantaneous power failure/undervoltage*1, Overload warning, Output frequency detection, Fault
		Relay output (two terminals)	The output signal can be changed using Pr.190 to Pr.196 (output terminal function selection) . Fault codes of the inverter can be output (4 bits) from the open collector.
		Pulse train output (FM type)	50 k pulses/s
	Indication	For meter	Pulse train output (FM type)
Current output (CA type)			Max. 20 mADC: one terminal (output current) The monitored item can be changed using Pr.54 FM/CA terminal function selection .
Voltage output			Max. 10 VDC: one terminal (output voltage) The monitored item can be changed using Pr.158 AM terminal function selection .
Operation panel (FR-DU08)		Operating status	Output frequency, output current, output voltage, frequency setting value The monitored item can be changed using Pr.52 Operation panel main monitor selection .
	Fault record	Fault record is displayed when a fault occurs. Past 8 fault records and the conditions immediately before the fault (output voltage/current/frequency/cumulative energization time/year/month/date/time) are saved.	
Protective/warning function	Protective function		Overcurrent trip during acceleration, Overcurrent trip during constant speed, Overcurrent trip during deceleration or stop, Regenerative overvoltage trip during acceleration, Regenerative overvoltage trip during constant speed, Regenerative overvoltage trip during deceleration or stop, Inverter overload trip (electronic thermal relay function), Motor overload trip (electronic thermal relay function), Heat sink overheat, Instantaneous power failure*1, Undervoltage*1, Input phase loss*1*2, Stall prevention stop, Loss of synchronism detection*2, Upper limit fault detection, Lower limit fault detection, Output side earth (ground) fault overcurrent, Output short circuit, Output phase loss, External thermal relay operation*2, PTC thermistor operation*2, Option fault, Communication option fault, Parameter storage device fault (control circuit board), PU disconnection, Retry count excess*2, Parameter storage device fault (main circuit board), CPU fault, Operation panel power supply short circuit/RS-485 terminals power supply short circuit, 24 VDC power fault, Abnormal output current detection*2, Inrush current limit circuit fault*1, Communication fault, Analog input fault, USB communication fault, Safety circuit fault, Overspeed occurrence*2, 4 mA input fault*2, Pre-charge fault*2, PID signal fault*2, Internal circuit fault, User definition error in the PLC function, Abnormal internal temperature*3, Internal storage device fault
	Warning function		Fan alarm, Stall prevention (overcurrent), Stall prevention (overvoltage), Electronic thermal relay function pre-alarm, PU stop, Parameter copy, Safety stop, Maintenance timer 1 to 3*2, USB host error, Operation panel lock*2, Password locked*2, Parameter write error, Copy operation error, 24 V external power supply operation, Internal fan alarm*3, Load fault warning, Emergency drive in operation*1, Continuous operation during communication fault*2, Ethernet communication fault*6

Environment	Surrounding air temperature	-10°C to +50°C (non-freezing) (LD rating) -10°C to +40°C (non-freezing) (SLD rating, or IP55 compatible model)
	Surrounding air humidity	With circuit board coating (conforming to class 3C2/3S2 in IEC 60721-3-3:1994), or IP55 compatible model: 95% RH or less (non-condensing) Without circuit board coating: 90% RH or less (non-condensing)
	Storage temperature*4	-20°C to +65°C
	Atmosphere	Indoors (without corrosive gas, flammable gas, oil mist, dust and dirt, etc.)
	Altitude/vibration	Maximum 2500 m (For the installation at an altitude above 1000 m, consider a 3% reduction in the rated current per 500 m increase in altitude.), 5.9 m/s ² or less*5 at 10 to 55 Hz (directions of X, Y, Z axes)

*1 Available for the standard model and the IP55 compatible model.

*2 This protective function is not available in the initial status.

*3 Available for the IP55 compatible model only.

*4 Temperature applicable for a short time, e.g. in transit.

*5 2.9 m/s² or less for the FR-F840-04320(185K) or higher.

*6 Available for the FR-F800-E only.

● PLC function specifications

Item		F800 PLC function specifications	
Control method		Repeated operation (by stored program)	
I/O control mode		Refresh	
Programming language		Relay symbolic language (ladder) Function block	
No. of instructions	Sequence instructions	25	
	Basic instructions	84	
	Application instructions	37	
Processing speed		Sequence instructions 1.9 μs to 12 μs/step*1	
Number of I/O device points		128 (input: 64 points, output: 64 points) 19 points built-in (input: 12 points, output: 7 points)*2 FR-A8AX (input: 16 points) FR-A8AY (output: 7 points) FR-A8AR (output: 3 points)	
Number of analog I/O points		3 input points built-in (Terminals 1, 2, and 4) 2 output points built-in (Terminals FM/CA and AM), FR-A8AY: 2 output points (AM0 and AM1)	
Pulse train I/O	Input	Terminal JOG maximum input pulse: 100k pulses/s *3	
	Output	Terminal FM maximum output pulse: 50k pulses/s *3	
Watchdog timer		10 to 2000 ms	
Program capacity		6K steps (24K bytes) (0 to 6144 steps can be set) Contained in one program	
Device	Internal relay (M)	128 (M0 to M127)	
	Latch relay (L)	Not used (Can be set with parameters but will not latch)*4	
	Timer (T)	Number of points	32 (T0 to T31)
		Specifications	100 ms timer: 0.1 to 3276.7 s can be set 10 ms timer: 0.01 to 327.67 s can be set
	Retentive timer (ST)	Number of points	16 (ST0 to ST15)*5, 32 (ST0 to ST31)*5
		Specifications	100 ms retentive timer: 0.1 to 3276.7 s can be set 10 ms retentive timer: 0.01 to 327.67 s can be set
	Counter (C)	Number of points	32 (C0 to C31)
		Specifications	Normal counter: Setting range 1 to 32767 Interrupt program counter: Not used
	Data register (D)	256 (D0 to D255)	
	Special relay (SM)	2048 (SM0 to SM2047) with limited functions	
Special register (SD)	2048 (SD0 to SD2047) with limited functions		

*1 The scan time is approximately 40 ms for 1K steps as inverter control is also performed in actual operations.

*2 The signals same as the ones assigned to the inverter I/O terminals are used.

One point is always required for a sequence start (RUN/STOP).

*3 **Pr.291 Pulse train I/O selection** must be set.

*4 There is no device latch function for power failures.

Use the **Pr.1150 to Pr.1199 PLC function user parameters 1 to 50** (D206 to D255) to store device values in the EEPROM.

*5 The initial value is "0".



NOTE

- There is no buffer memory.

Outline Dimensions

● Standard model

FR-F820-00046(0.75K), FR-F820-00077(1.5K)(-E)

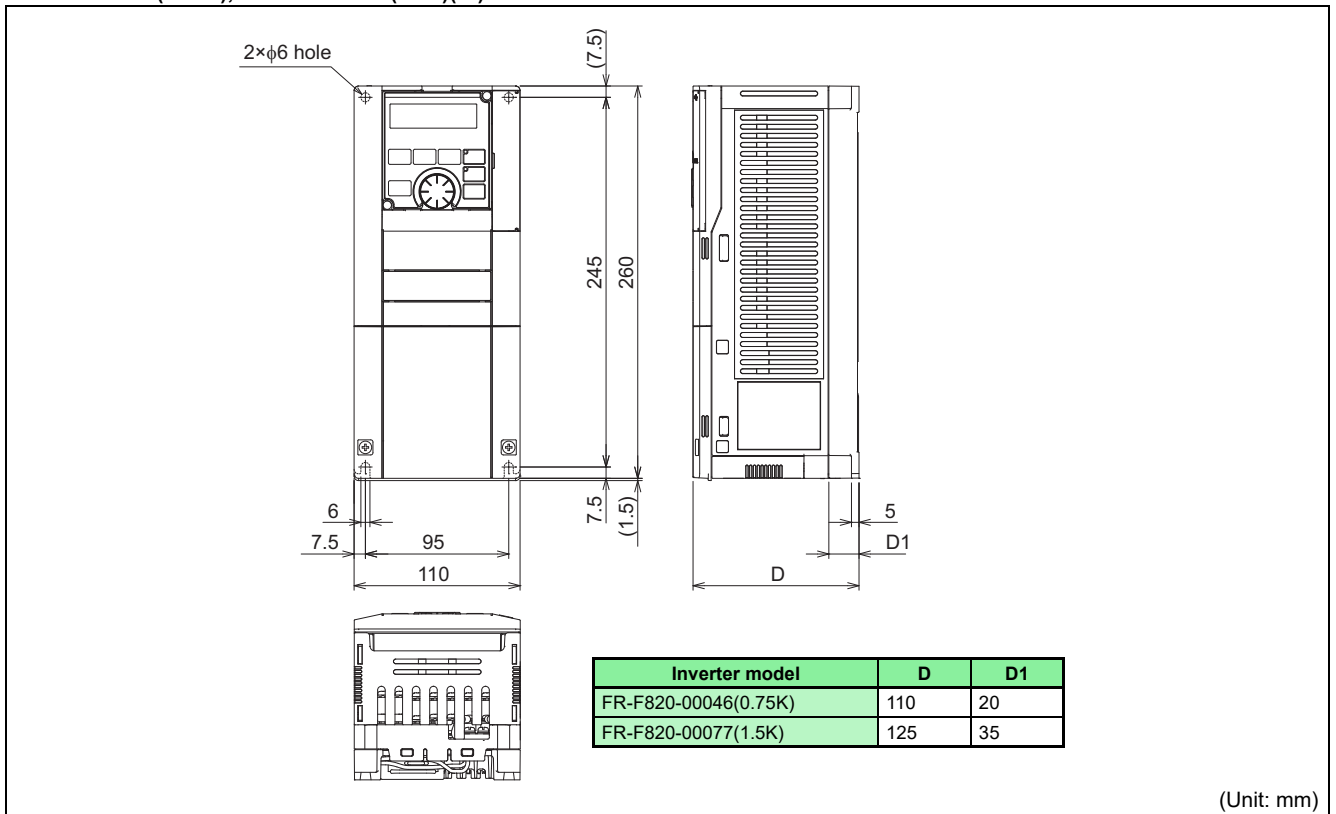

FR-F820-00105(2.2K), 00167(3.7K), 00250(5.5K)(-E)

FR-F840-00023(0.75K), 00038(1.5K), 00052(2.2K), 00083(3.7K), 00126(5.5K)(-E)

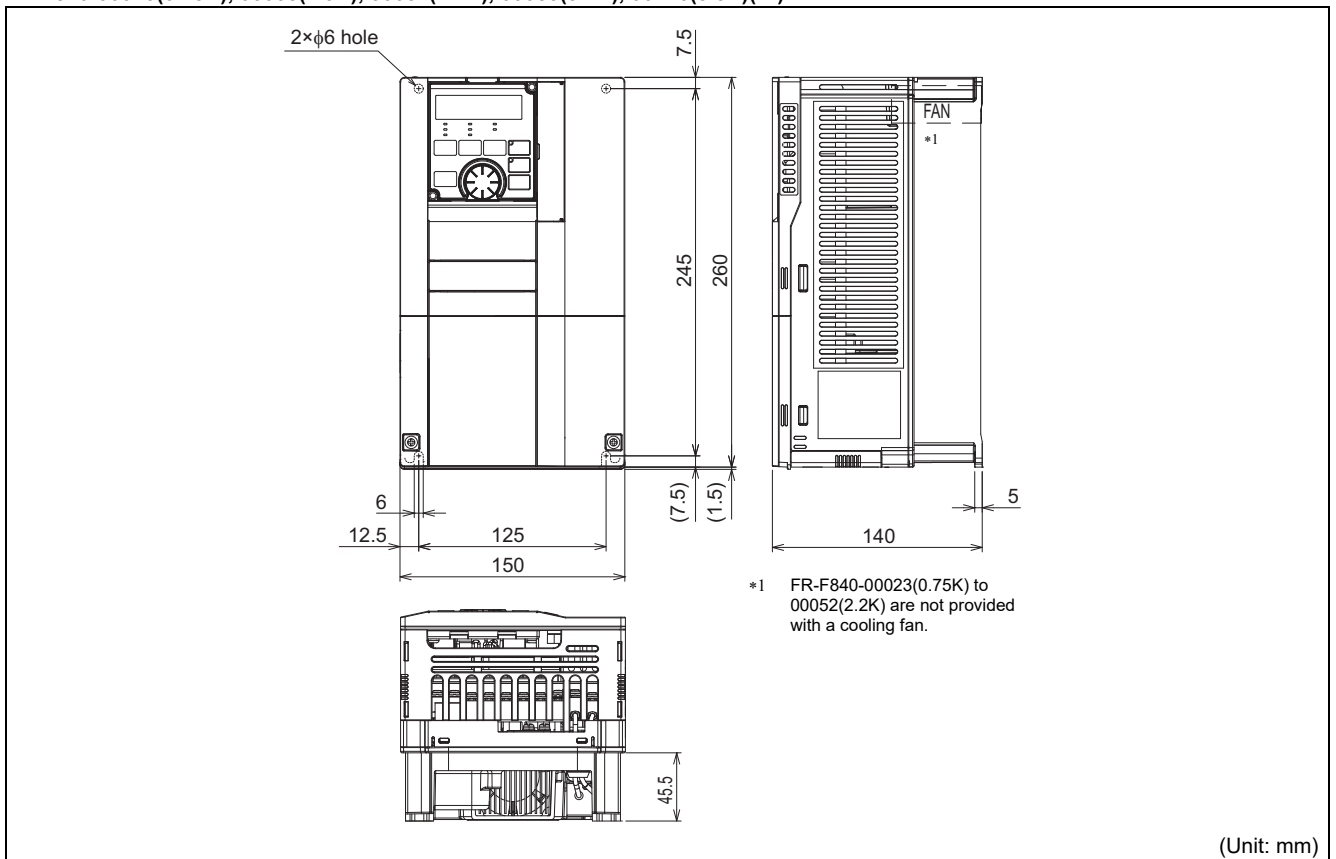

5

Outline Dimensions

FR-F820-00340(7.5K), 00490(11K), 00630(15K)(-E)
 FR-F840-00170(7.5K), 00250(11K), 00310(15K), 00380(18.5K)(-E)

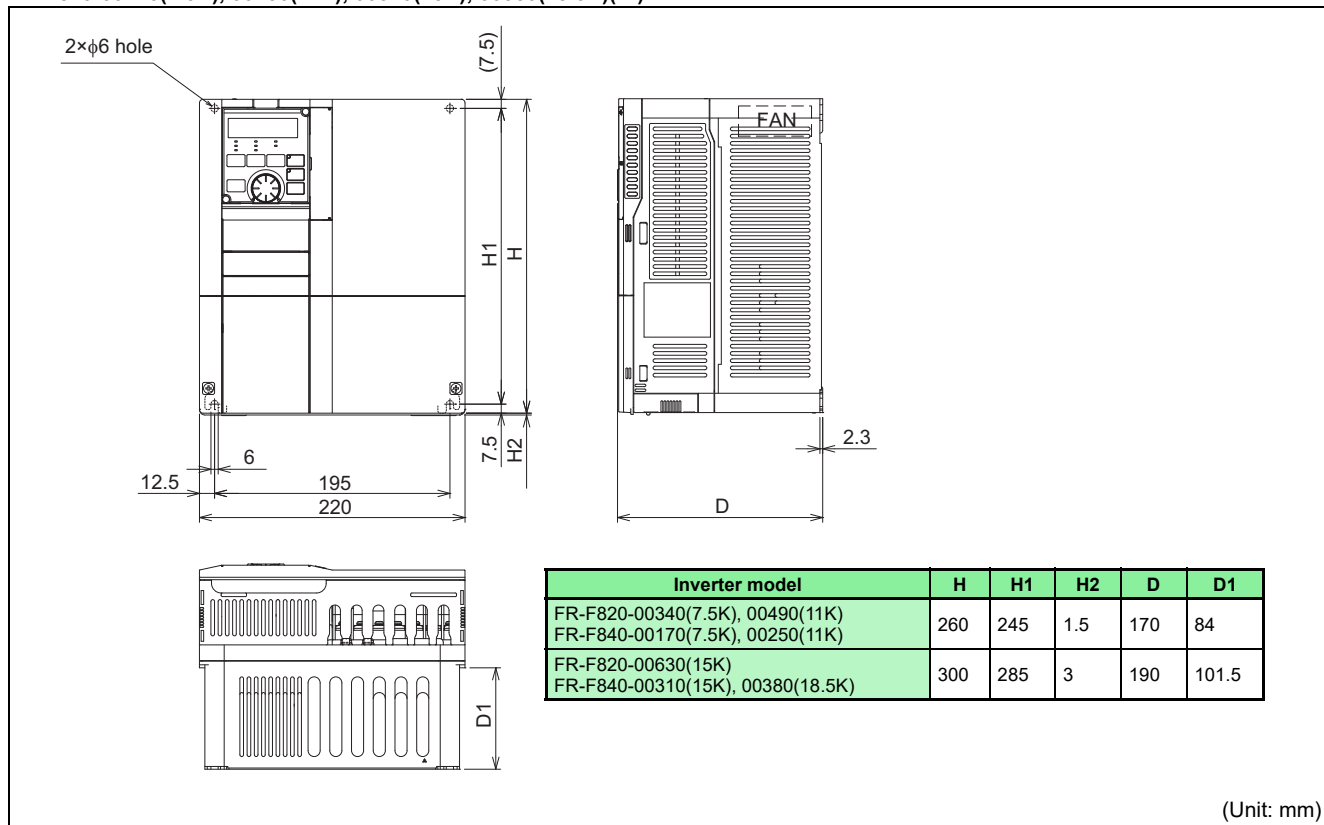

FR-F820-00770(18.5K), 00930(22K), 01250(30K)(-E)
 FR-F840-00470(22K), 00620(30K)(-E)

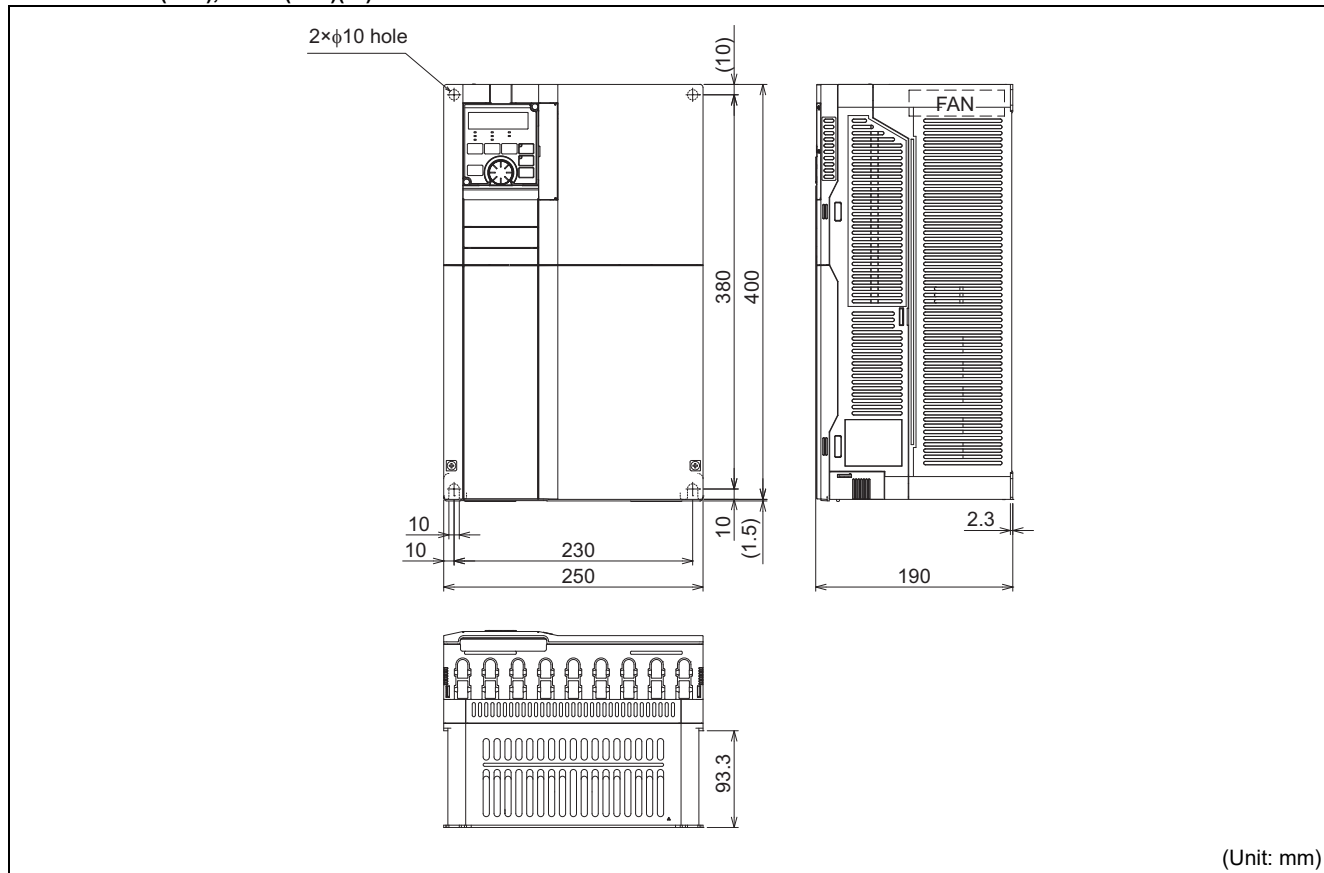

FR-F820-01540(37K)(-E)
FR-F840-00770(37K)(-E)

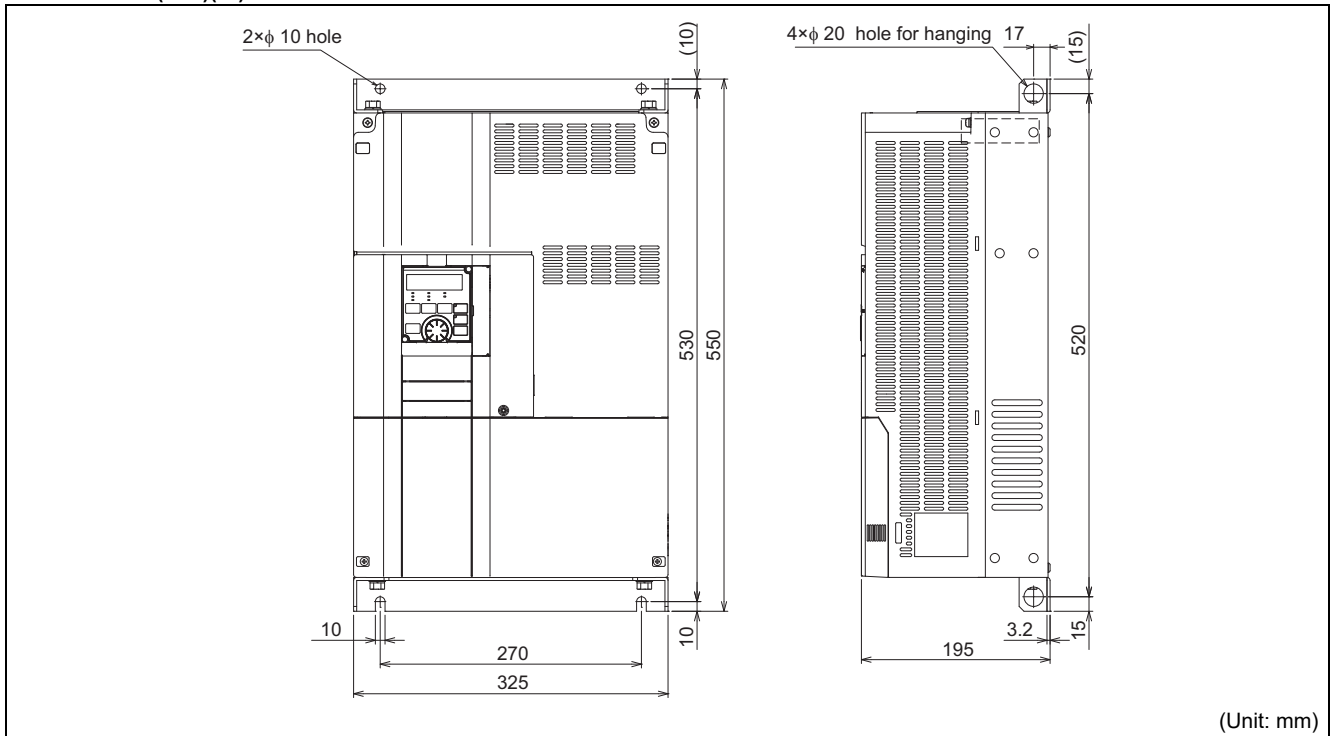

(Unit: mm)

FR-F820-01870(45K), 02330(55K), 03160(75K), 03800(90K), 04750(110K)(-E)
FR-F840-00930(45K), 01160(55K), 01800(75K), 02160(90K), 02600(110K), 03250(132K), 03610(160K)(-E)

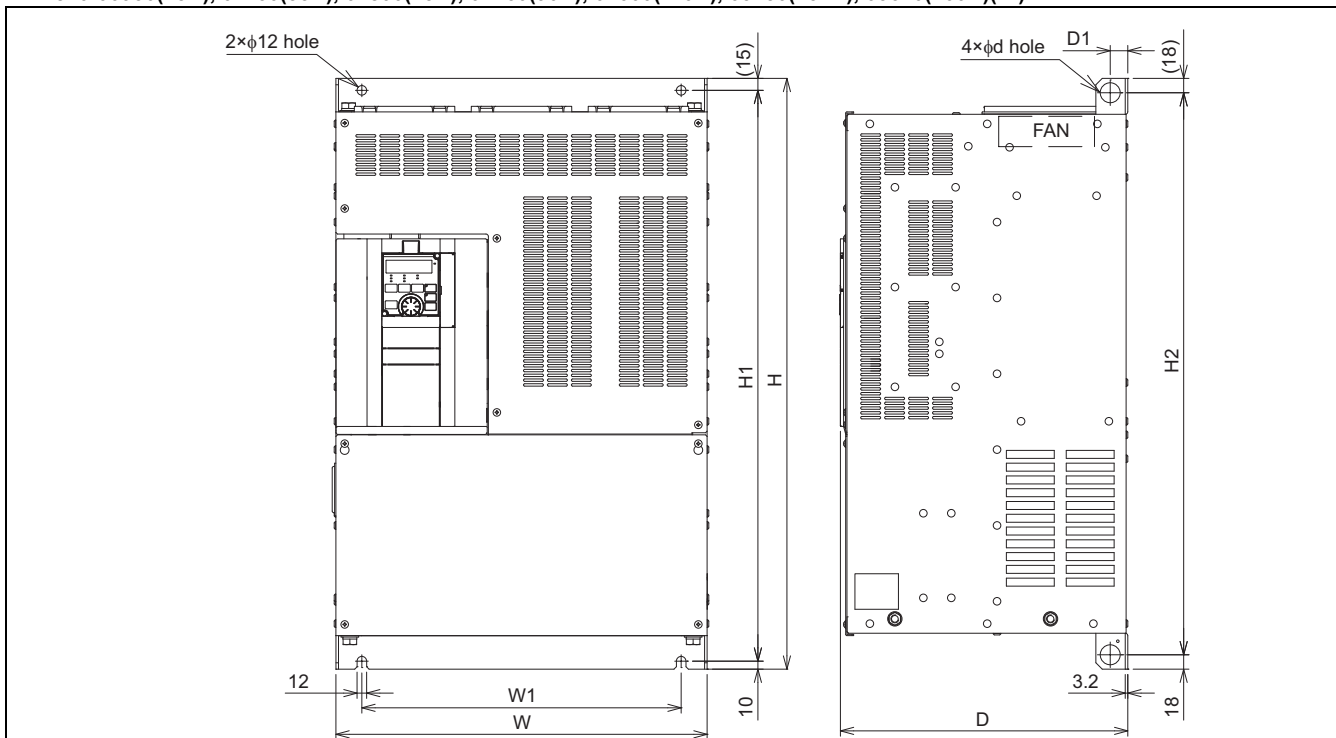

Inverter model	W	W1	H	H1	H2	d	D	D1
FR-F820-01870(45K), 02330(55K) FR-F840-00930(45K), 01160(55K), 01800(75K)*2	435	380	550	525	514	25	250	24
FR-F820-03160(75K)*2	465	410	700	675	664	25	250	22
FR-F820-03800(90K)*2, 04750(110K)*2	465	400	740	715	704	24	360	22
FR-F840-02160(90K)*2, 02600(110K)*2	465	400	620	595	584	24	300	22
FR-F840-03250(132K)*2, 03610(160K)*2	465	400	740	715	704	25	360	22

*2 Always connect a DC reactor (FR-HEL), which is available as an option.

(Unit: mm)

5

Outline Dimensions

FR-F840-04320(185K), 04810(220K)(-E)

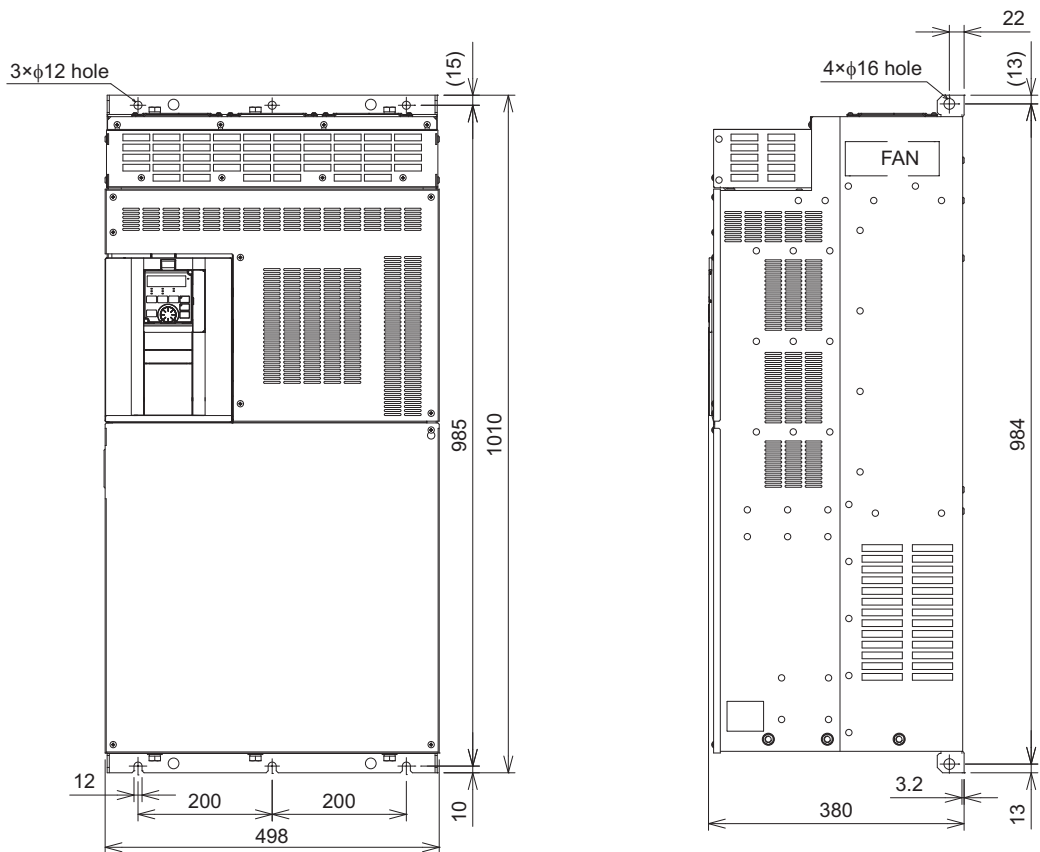

Always connect a DC reactor (FR-HEL), which is available as an option.

(Unit: mm)

FR-F840-05470(250K), 06100(280K), 06830(315K)(-E)

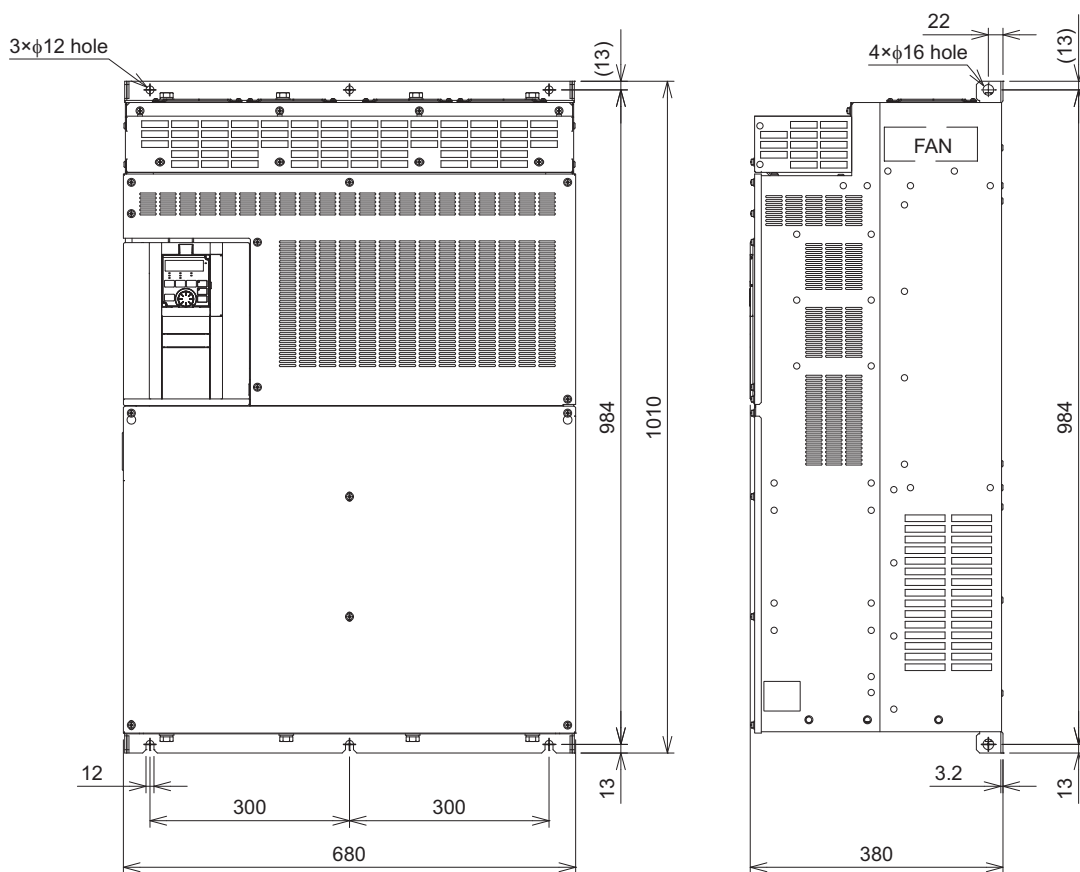

Always connect a DC reactor (FR-HEL), which is available as an option.

(Unit: mm)

● Separated converter type

◆ Inverter

FR-F842-07700(355K), 08660(400K)(-E)

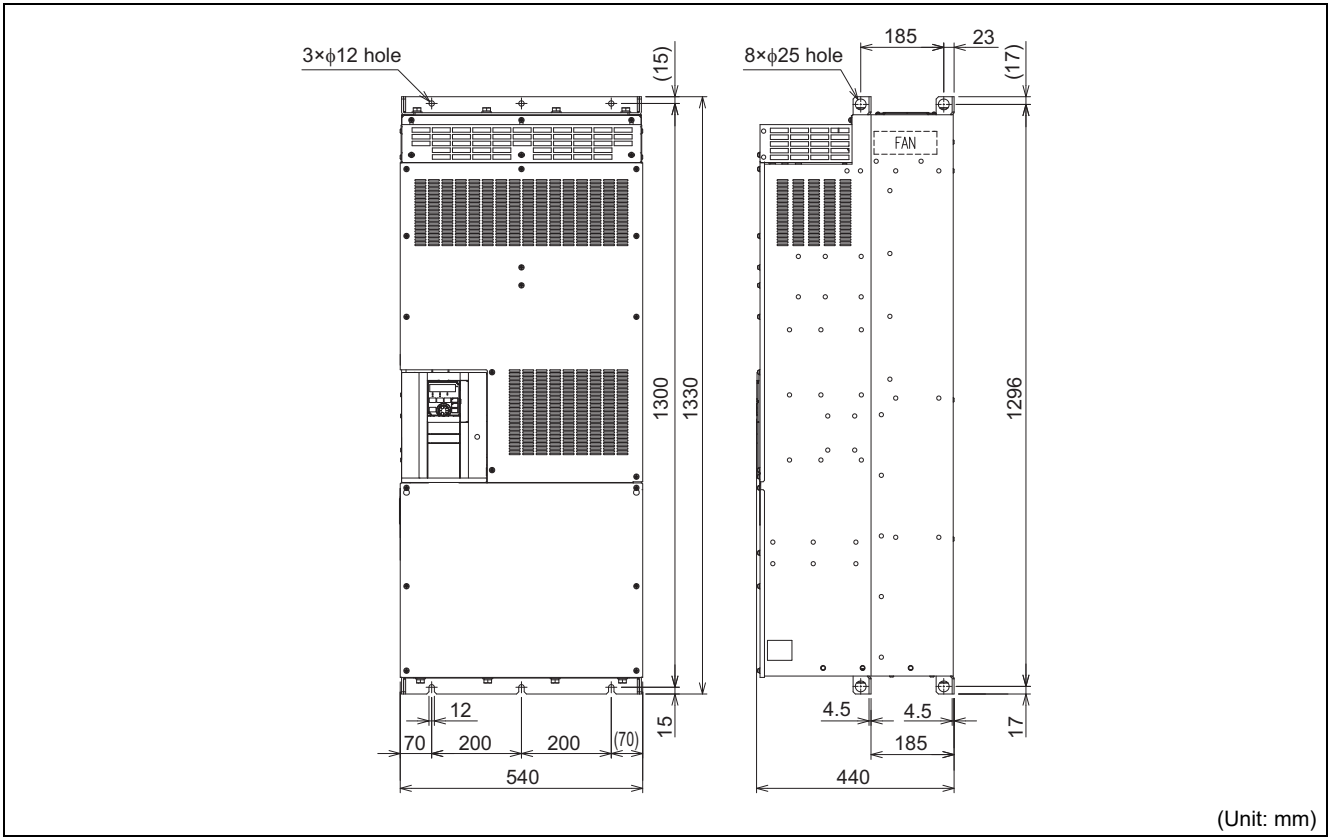

FR-F842-09620(450K), 10940(500K), 12120(560K)(-E)

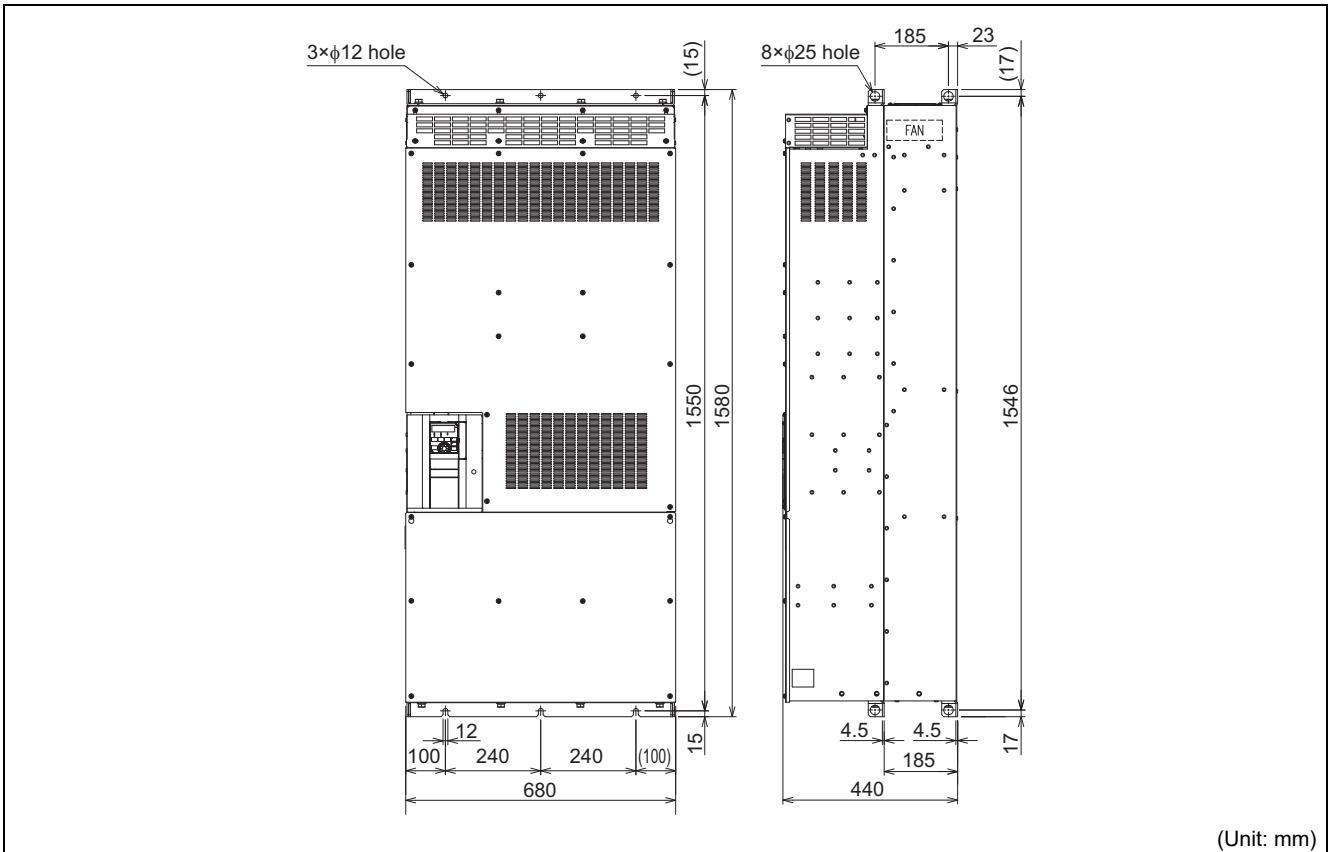

◆ Converter unit
FR-CC2-H355K

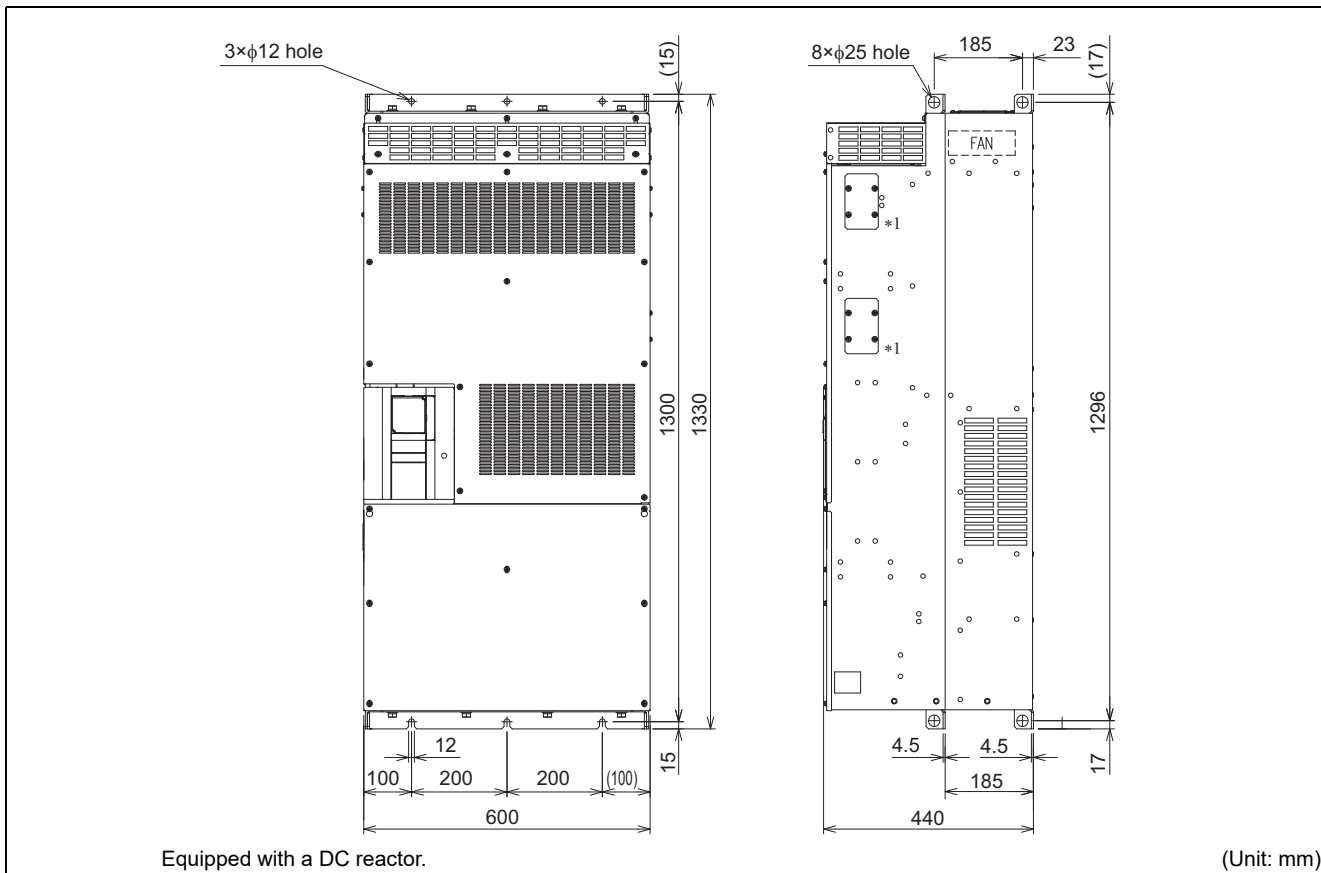

FR-CC2-H400K, H450K, H500K, H560K, H630K

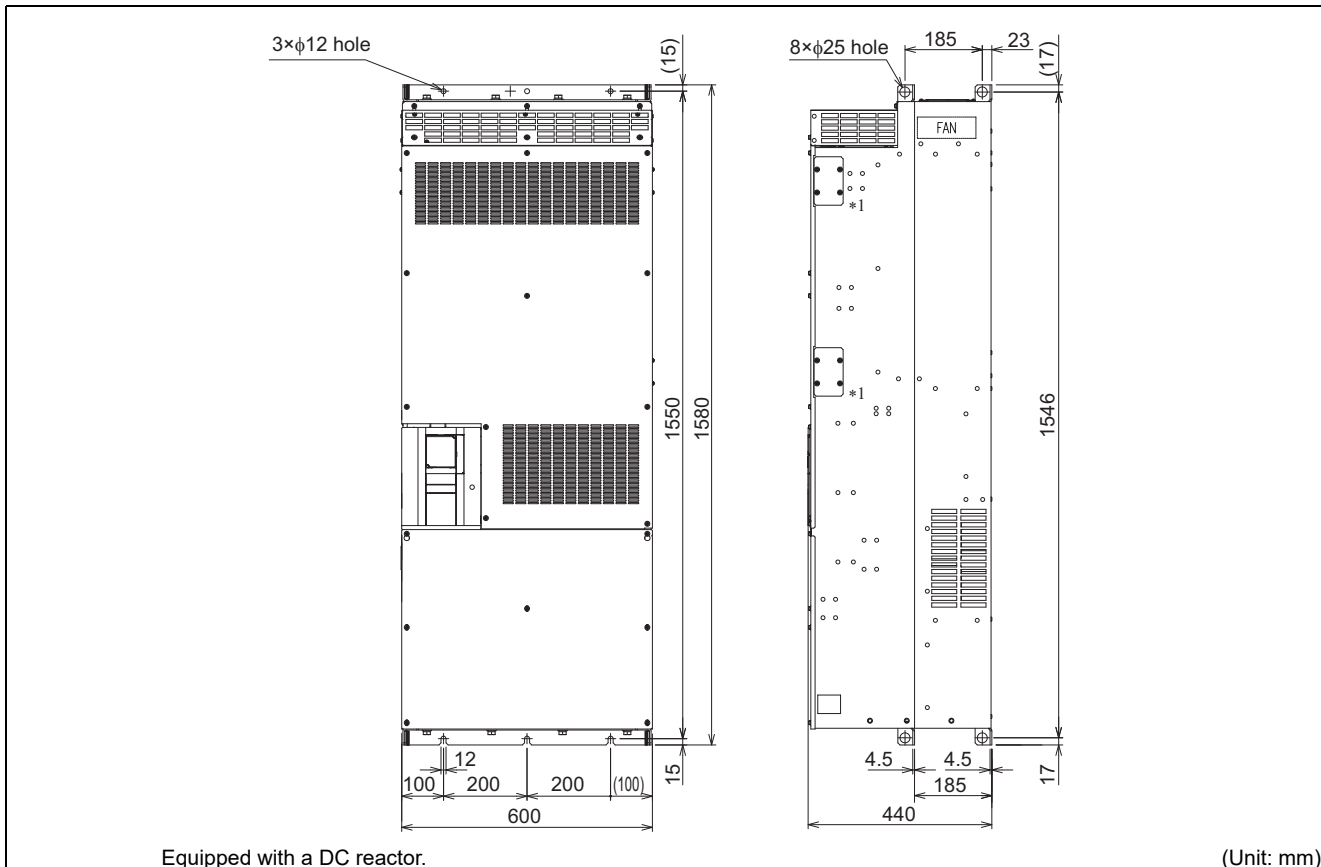

*1 Do not remove the cover on the side of the converter unit.

● IP55 compatible model

A DC reactor is built in.

FR-F846-00023(0.75K), 00038(1.5K), 00052(2.2K), 00083(3.7K), 00126(5.5K), 00170(7.5K)(-E)

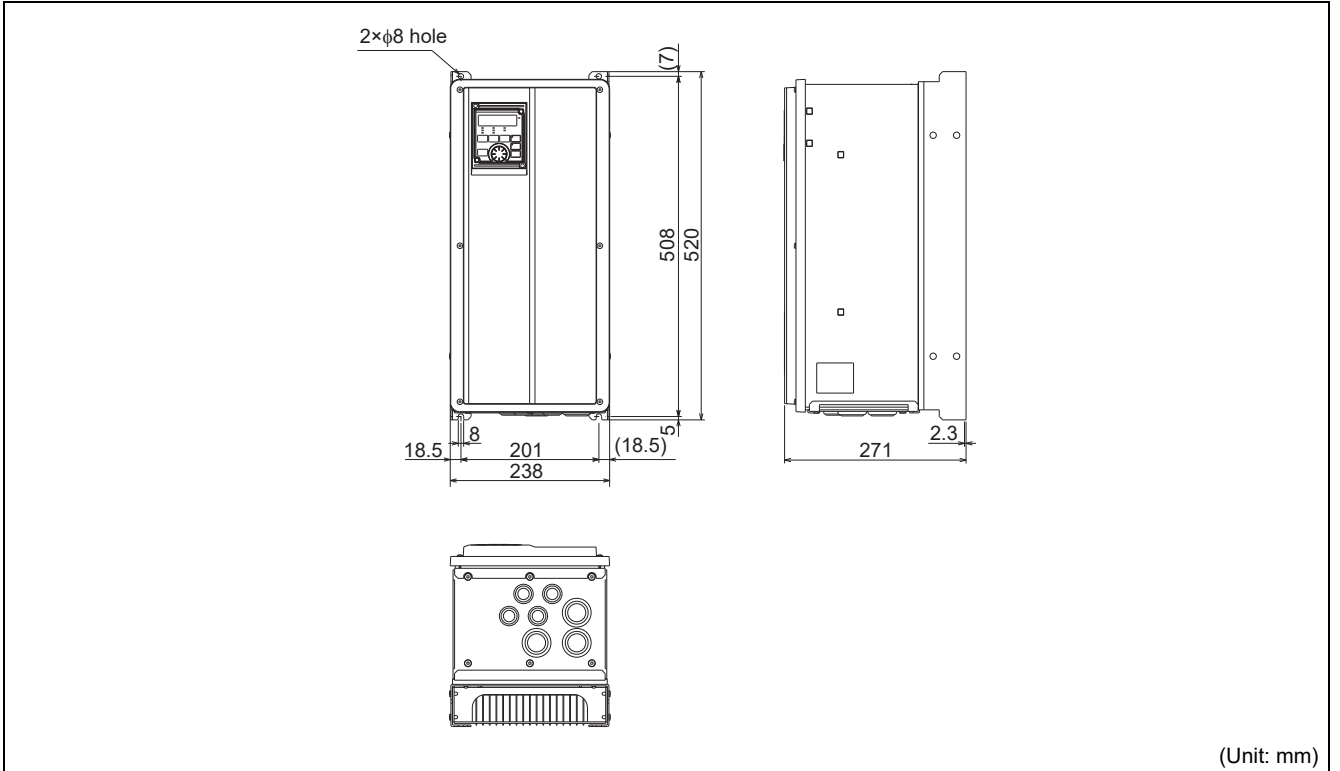

FR-F846-00250(11K), 00310(15K), 00380(18.5K), 00470(22K)(-E)

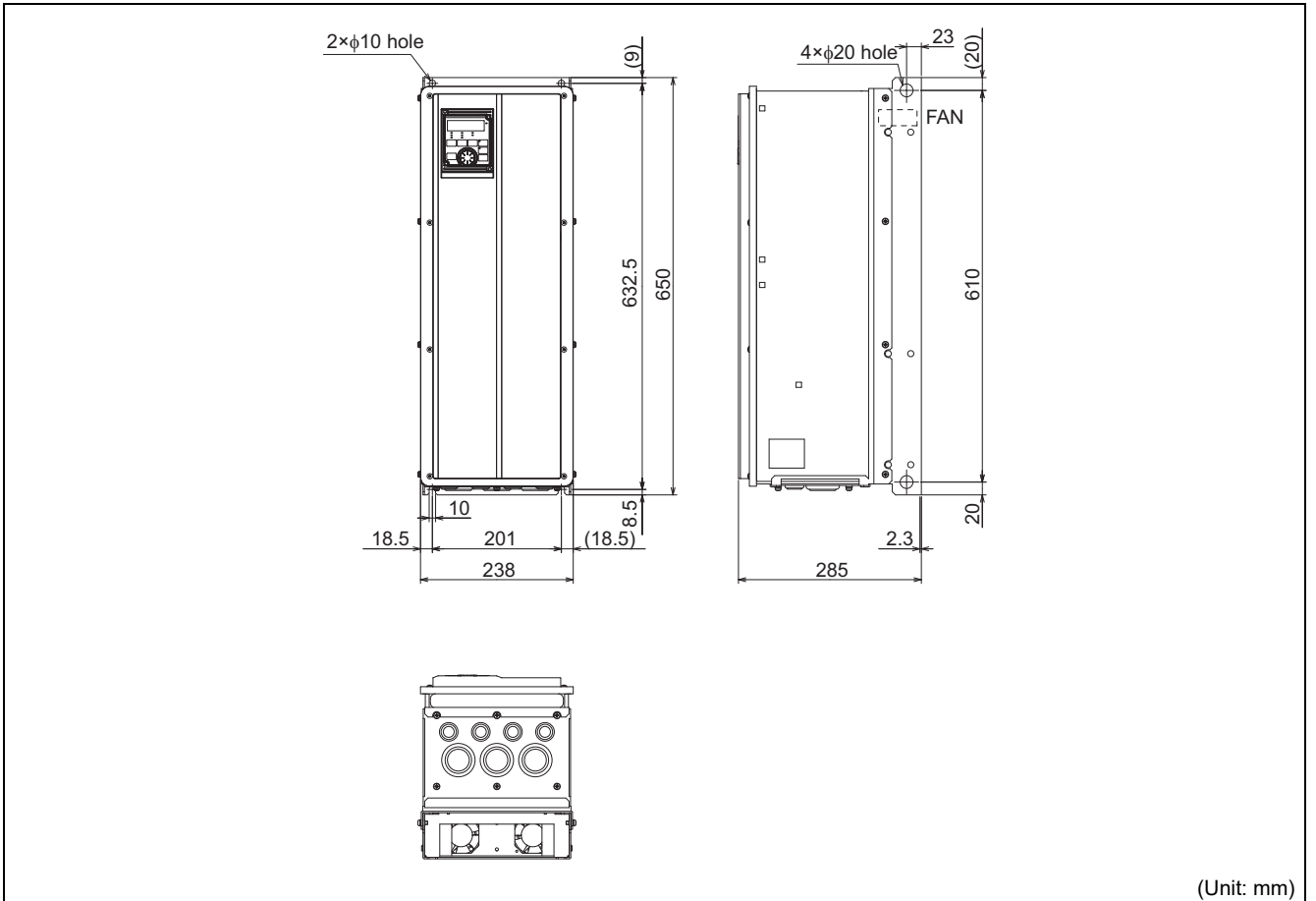

FR-F846-00620(30K), 00770(37K), 00930(45K), 01160(55K)(-E)

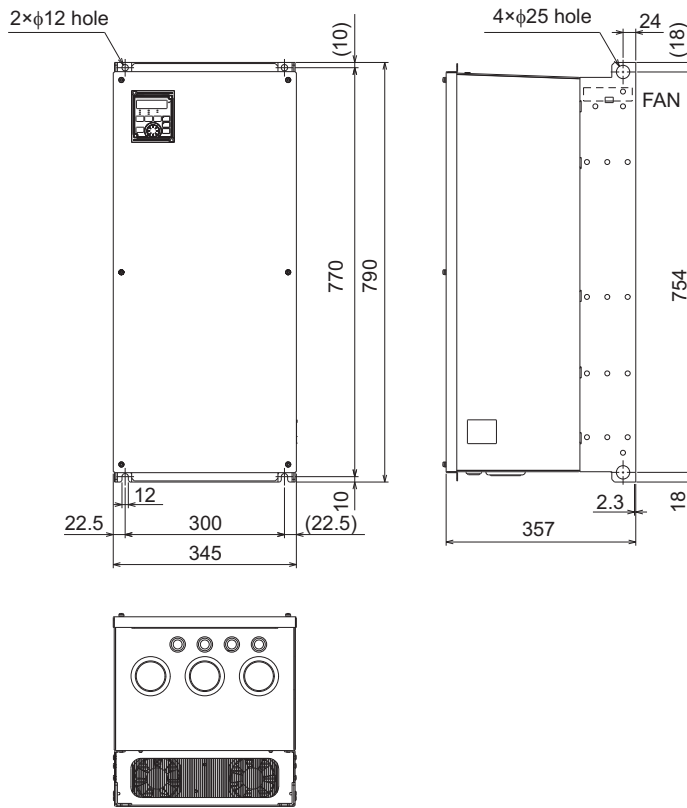

(Unit: mm)

FR-F846-01800(75K), 02160(90K), 02600(110K), 03250(132K), 03610(160K)(-E)

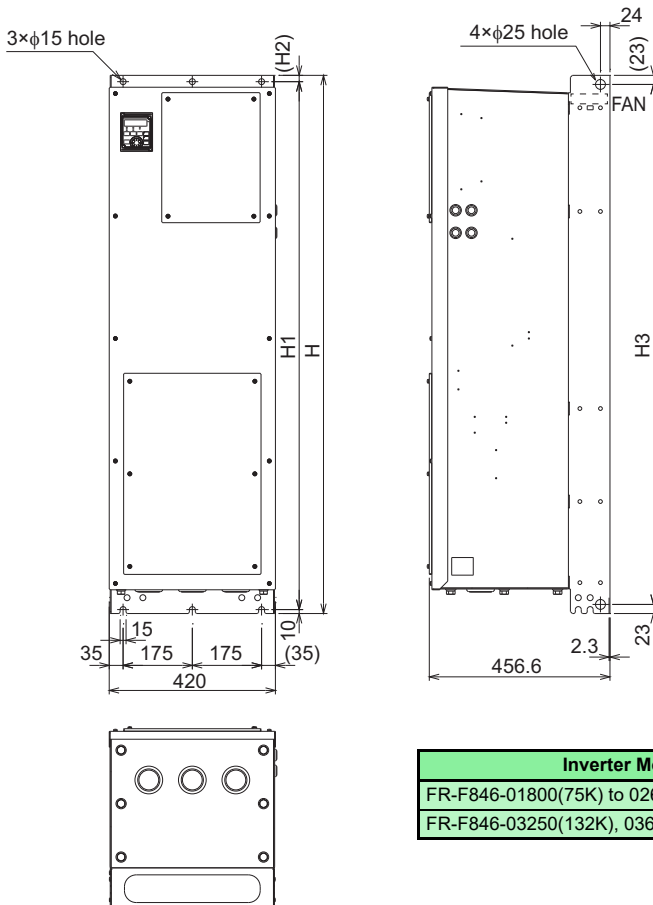

Inverter Model	H	H1	H2	H3
FR-F846-01800(75K) to 02600(110K)	1360	1334	16	1314
FR-F846-03250(132K), 03610(160K)	1510	1482	18	1464

(Unit: mm)

● Operation panel (FR-DU08, FR-LU08)

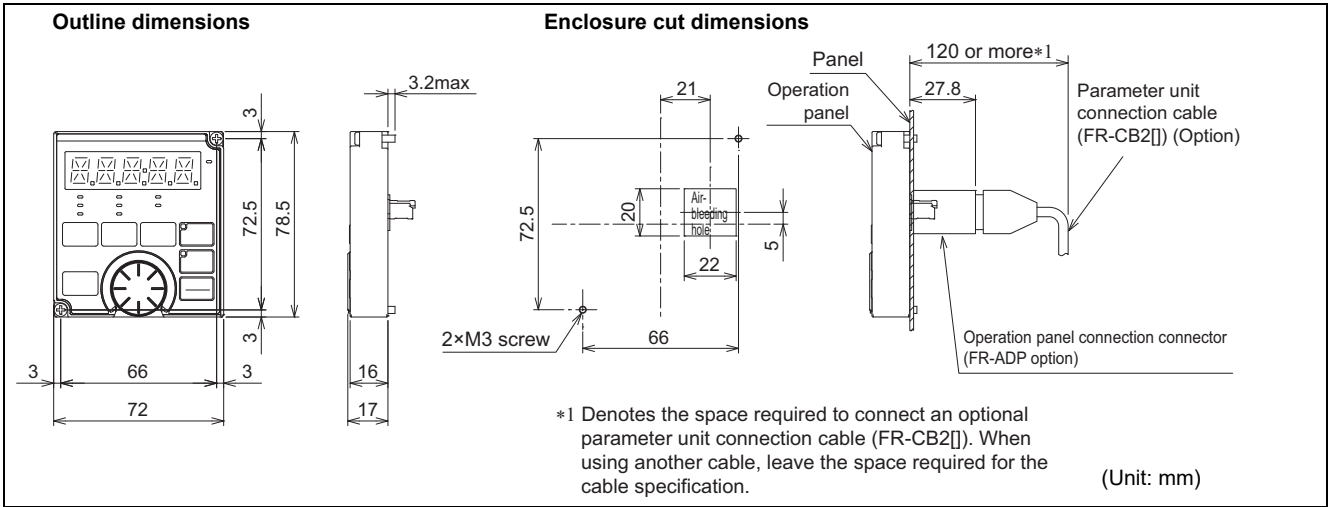

● Protruding the heat sink through the panel

When encasing the inverter or the converter unit in an enclosure, the heat generated in the enclosure can be greatly reduced by protruding the heat sink of the inverter or the converter unit. When installing the inverter in a compact enclosure, etc., this installation method is recommended. For the FR-F840-04320(185K) or higher, a heat sink can be protruded outside the enclosure without using an attachment.

◆ When using a panel through attachment (FR-A8CN)

For the FR-F820-00105(2.2K) to FR-F820-04750(110K) and FR-F840-00023(0.75K) to FR-F840-03610(160K), a heat sink can be protruded outside the enclosure using a panel through attachment (FR-A8CN). Refer to the instruction manual of the panel through attachment (FR-A8CN) for details.

- Drawing after attachment installation (when used with the FR-A8CN)

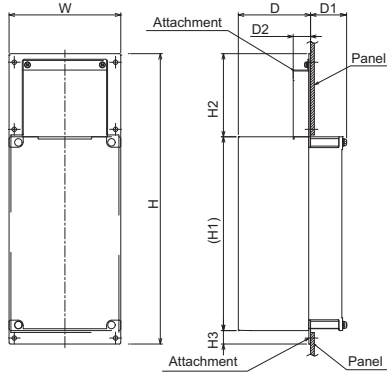

Type	W	H	H1	H2	H3	D	D1	D2
FR-A8CN01	150	389.5	260	111.5	18	97	48.4	24.3
FR-A8CN02	245	408.5	260	116.5	32	86	89.4	21.3
FR-A8CN03	245	448.5	300	116.5	32	89	106.4	21.3
FR-A8CN04	280	554	400	113.5	32	96.7	102.4	40.6
FR-A8CN05	357	654	480	130	44	130.8	64.2	105
FR-A8CN06	478.2	650	465	145	40	96	154	55
FR-A8CN07	510.2	805	610	150	45	130	120	105
FR-A8CN08	510.2	845	650	150	45	176.5	183.5	40
FR-A8CN09	510.2	725	530	150	45	152.3	147.7	65

(Unit: mm)

- Enclosure cut dimensions (when used with the FR-A8CN)

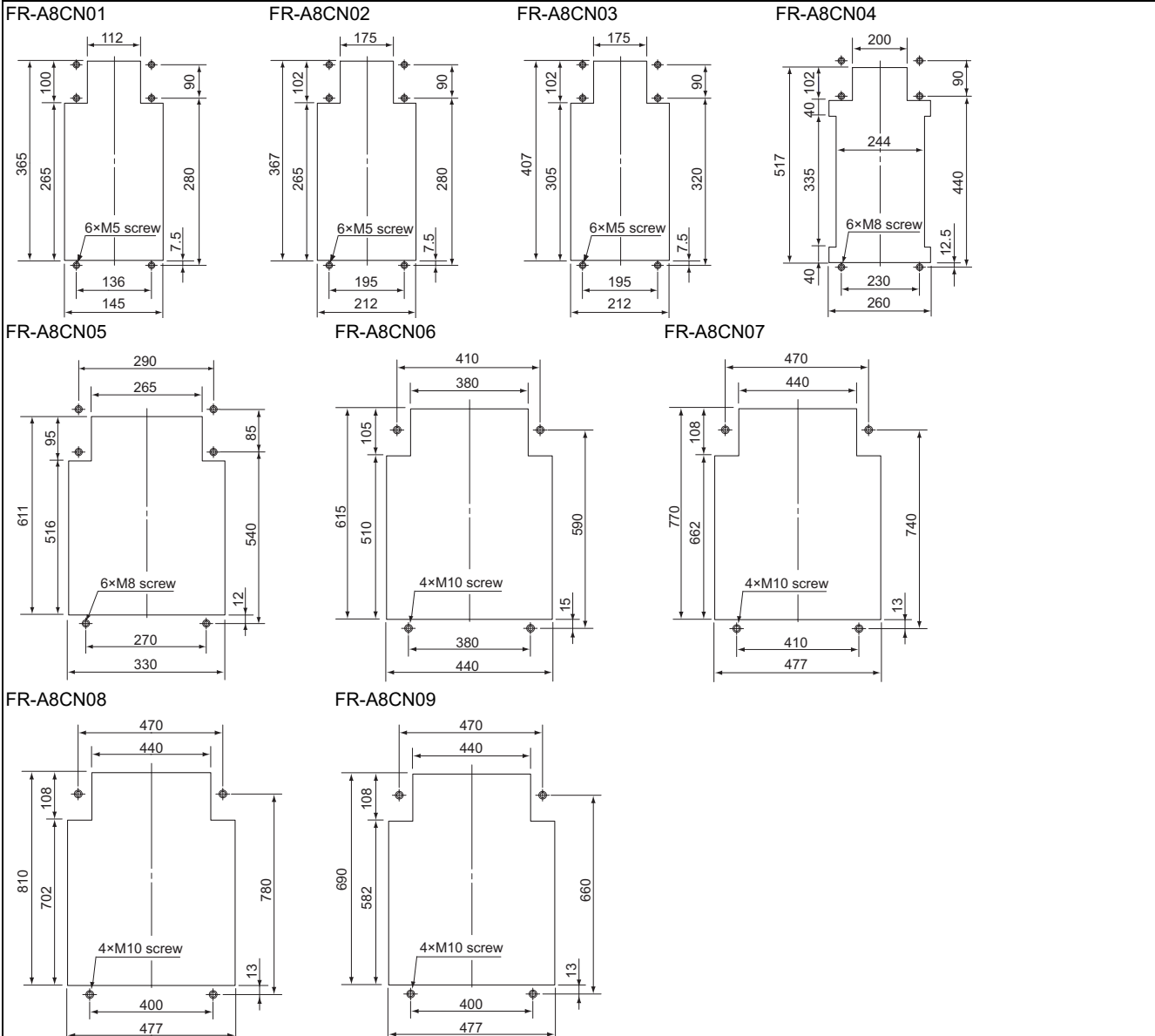

For a compatibility table between the attachment and the inverter, refer to **page 93**.

◆ Heat sink protrusion through the panel for the FR-F840-04320(185K) or higher

- Enclosure cutting

Cut an enclosure according to the capacity of the inverter or the converter unit.

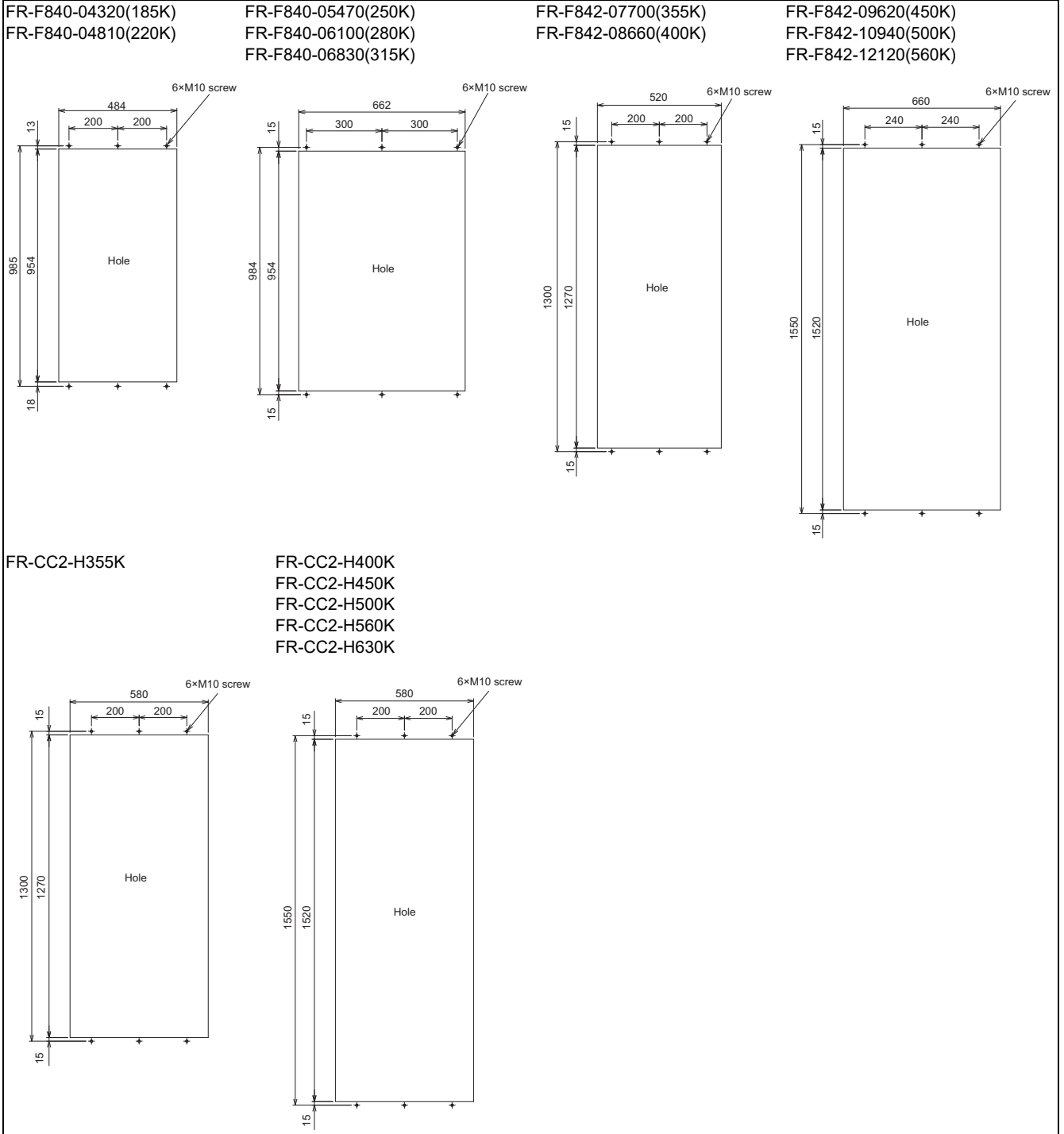

- Shift and removal of a rear side installation frame
For the FR-F840-04320(185K) to FR-F840-06830(315K)

One installation frame is attached to each of the upper and lower parts of the inverter. Change the position of the rear side installation frame on the upper and lower sides of the inverter to the front side as shown below. When changing the installation frames, make sure that the installation orientation is correct.

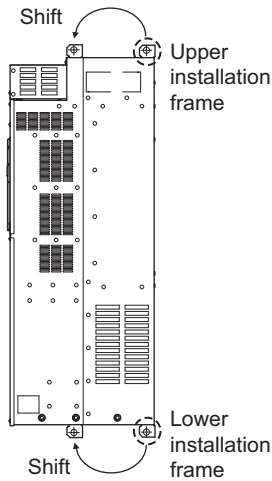

- For the FR-F842-07700(355K) to FR-F842-12120(560K), FR-CC2-H355K to FR-CC2-H630K

Two installation frames are attached to each of the upper and lower parts of the inverter or the converter unit. Remove the rear side installation frame on the upper and lower sides of the inverter or the converter unit as shown below.

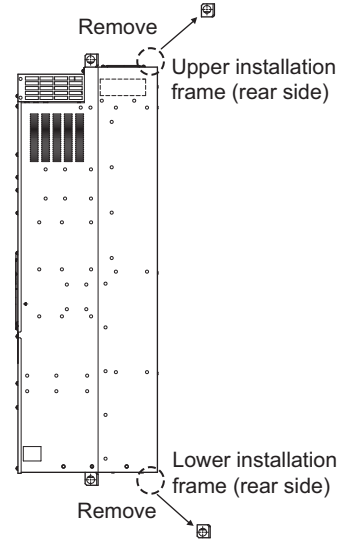

- Installation of the inverter or the converter unit
Push the inverter heat sink portion outside the enclosure and fix the enclosure and the inverter or the converter unit with upper and lower installation frame.

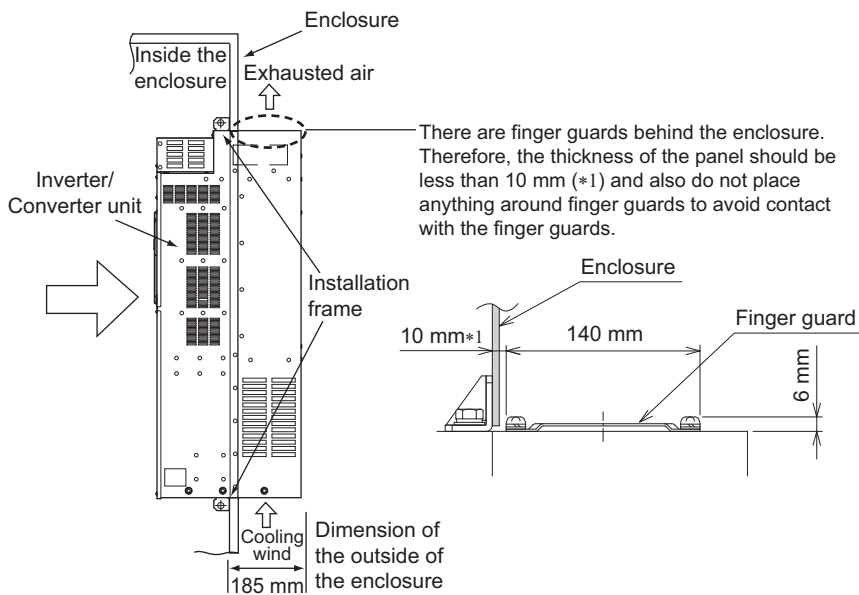

NOTE

- Having a cooling fan, the cooling section which comes out of the enclosure cannot be used in the environment of water drops, oil, mist, dust, etc.
- Be careful not to drop screws, dust etc. into the inverter or the converter unit and the cooling fan section.
- The FR-A7CN panel through attachment cannot be installed on the FR-F800 series.

Terminal Connection Diagram

● Standard models and IP55 compatible models

◆ FM type

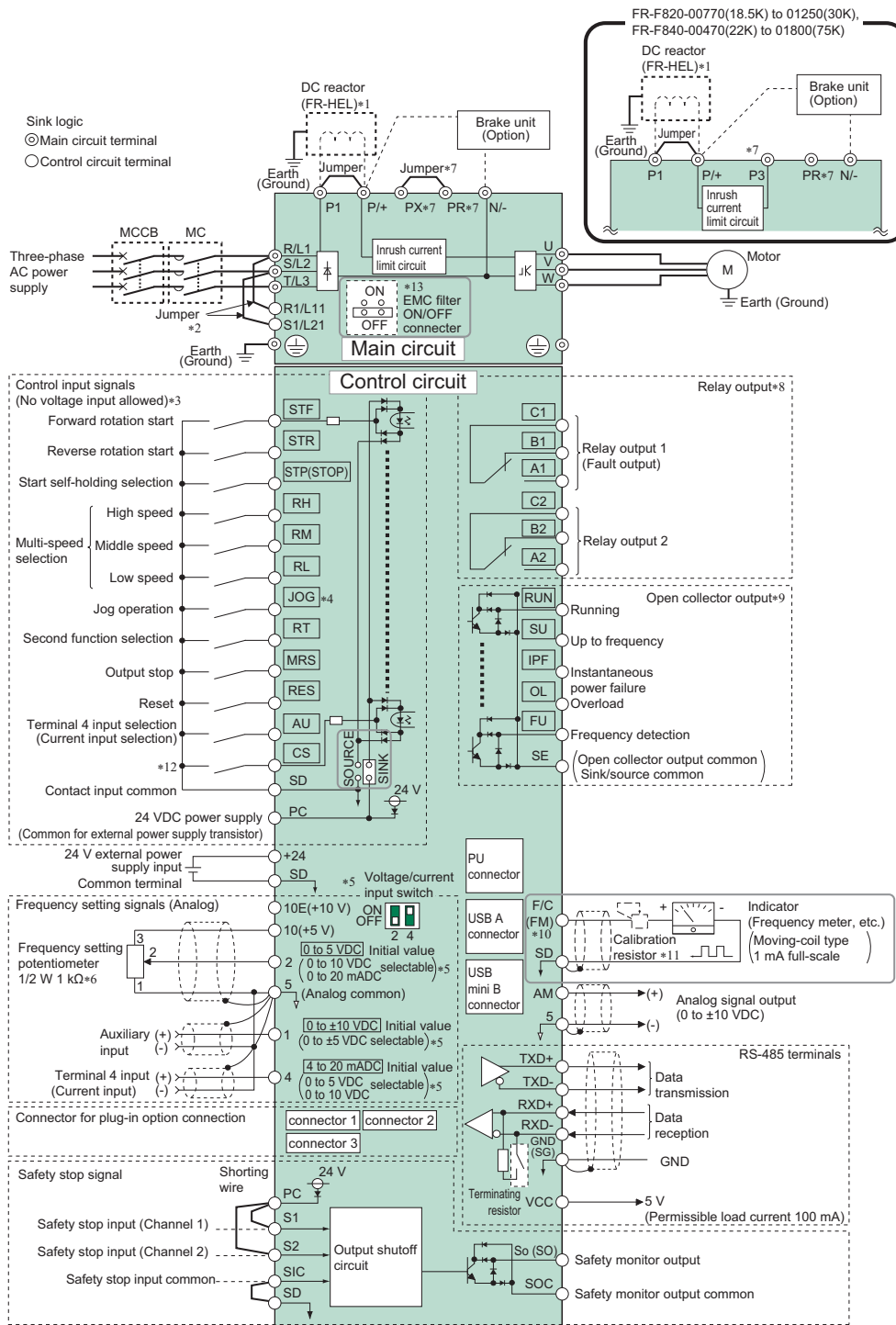

- *1 For the FR-F820-03160(75K) or higher, the FR-F840-01800(75K) or higher, always connect a DC reactor (FR-HEL), which is available as an option. (To select a DC reactor, refer to **page 21**, **page 124**, and select one according to the applicable motor capacity.) When connecting a DC reactor, if a jumper is installed across terminals P1 and P+, remove the jumper before installing the DC reactor. The IP55 compatible model is equipped with a DC reactor. (A jumper is not installed in the FR-F820-03160(75K) or higher and the FR-F840-01800(75K) or higher.)
- *2 When using separate power supply for the control circuit, remove the jumper between R1/L11 and S1/L21. The IP55 compatible model does not have terminals R1/L11 and S1/L21, and a jumper.
- *3 The function of these terminals can be changed with the input terminal assignment (**Pr.178 to Pr.189**).
- *4 Terminal JOG is also used as the pulse train input terminal. Use **Pr.291** to choose JOG or pulse.
- *5 Terminal input specifications can be changed by analog input specification switchover (**Pr.73**, **Pr.267**). To input a voltage, set the voltage/current input switch OFF. To input a current, set the voltage/current input switch ON. Terminals 10 and 2 are also used as a PTC input terminal. (**Pr.561**)
- *6 It is recommended to use 2 W 1 k Ω when the frequency setting signal is changed frequently.
- *7 Do not use terminals PR, PX, and P3. The jumper may or may not be attached depending on the inverter. (Refer to the Instruction Manual (Startup).) The IP55 compatible model does not have terminals PR, PX, and P3, and a jumper.
- *8 The function of these terminals can be changed with the output terminal assignment (**Pr.195**, **Pr.196**).
- *9 The function of these terminals can be changed with the output terminal assignment (**Pr.190 to Pr.194**).
- *10 The terminal F/C (FM) can be used to output pulse trains as open collector output by setting **Pr.291**.
- *11 Not required when calibrating the scale with the operation panel.
- *12 No function is assigned in the initial status. Assign the function using **Pr.186 CS terminal function selection**.
- *13 For the inverter with a built-in C2 filter (IP55 compatible model), do not change the initially set ON (enabled) position of the EMC filter ON/OFF connector. The Class C2 compatibility condition is not satisfied with the EMC filter OFF. The FR-F846-00250(11K)-C2 to FR-F846-00470(22K)-C2 are not equipped with an EMC filter ON/OFF connector. The EMC filter is always ON.

◆ CA type

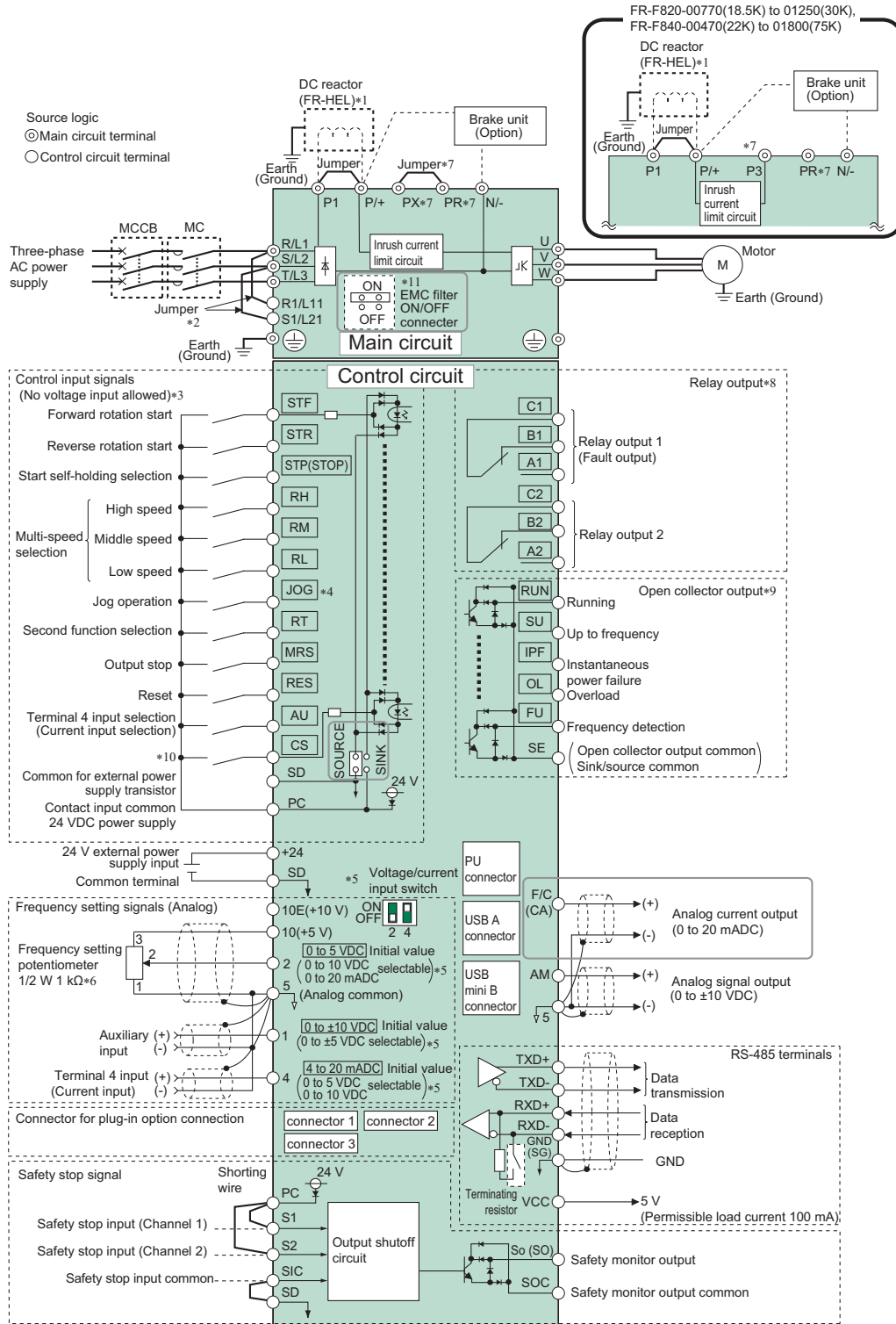

- *1 For the FR-F820-03160(75K) or higher, the FR-F840-01800(75K) or higher, always connect a DC reactor (FR-HEL), which is available as an option. (To select a DC reactor, refer to **page 21**, **page 124**, and select one according to the applicable motor capacity.) When connecting a DC reactor, if a jumper is installed across terminals P1 and P/+, remove the jumper before installing the DC reactor. The IP55 compatible model is equipped with a DC reactor. (A jumper is not installed in the FR-F820-03160(75K) or higher and the FR-F840-01800(75K) or higher.)
- *2 When using separate power supply for the control circuit, remove the jumper between R1/L11 and S1/L21. The IP55 compatible model does not have terminals R1/L11 and S1/L21, and a jumper.
- *3 The function of these terminals can be changed with the input terminal assignment (**Pr.178 to Pr.189**).
- *4 Terminal JOG is also used as the pulse train input terminal. Use **Pr.291** to choose JOG or pulse.
- *5 Terminal input specifications can be changed by analog input specification switchover (**Pr.73**, **Pr.267**). To input a voltage, set the voltage/current input switch OFF. To input a current, set the voltage/current input switch ON. Terminals 10 and 2 are also used as a PTC input terminal. (**Pr.561**)
- *6 It is recommended to use 2 W 1 kΩ when the frequency setting signal is changed frequently.
- *7 Do not use terminals PR, PX, and P3. The jumper may or may not be attached depending on the inverter. (Refer to the Instruction Manual (Startup).) The IP55 compatible model does not have terminals PR, PX, and P3, and a jumper.
- *8 The function of these terminals can be changed with the output terminal assignment (**Pr.195**, **Pr.196**).
- *9 The function of these terminals can be changed with the output terminal assignment (**Pr.190 to Pr.194**).
- *10 No function is assigned in the initial status. Assign the function using **Pr.186 CS terminal function selection**.
- *11 For the inverter with a built-in C2 filter (IP55 compatible model), do not change the initially set ON (enabled) position of the EMC filter ON/OFF connector. The Class C2 compatibility condition is not satisfied with the EMC filter OFF. The FR-F846-00250(11K)-C2 to FR-F846-00470(22K)-C2 are not equipped with an EMC filter ON/OFF connector. The EMC filter is always ON.

● Separated converter type

◆ Inverter (FM type)

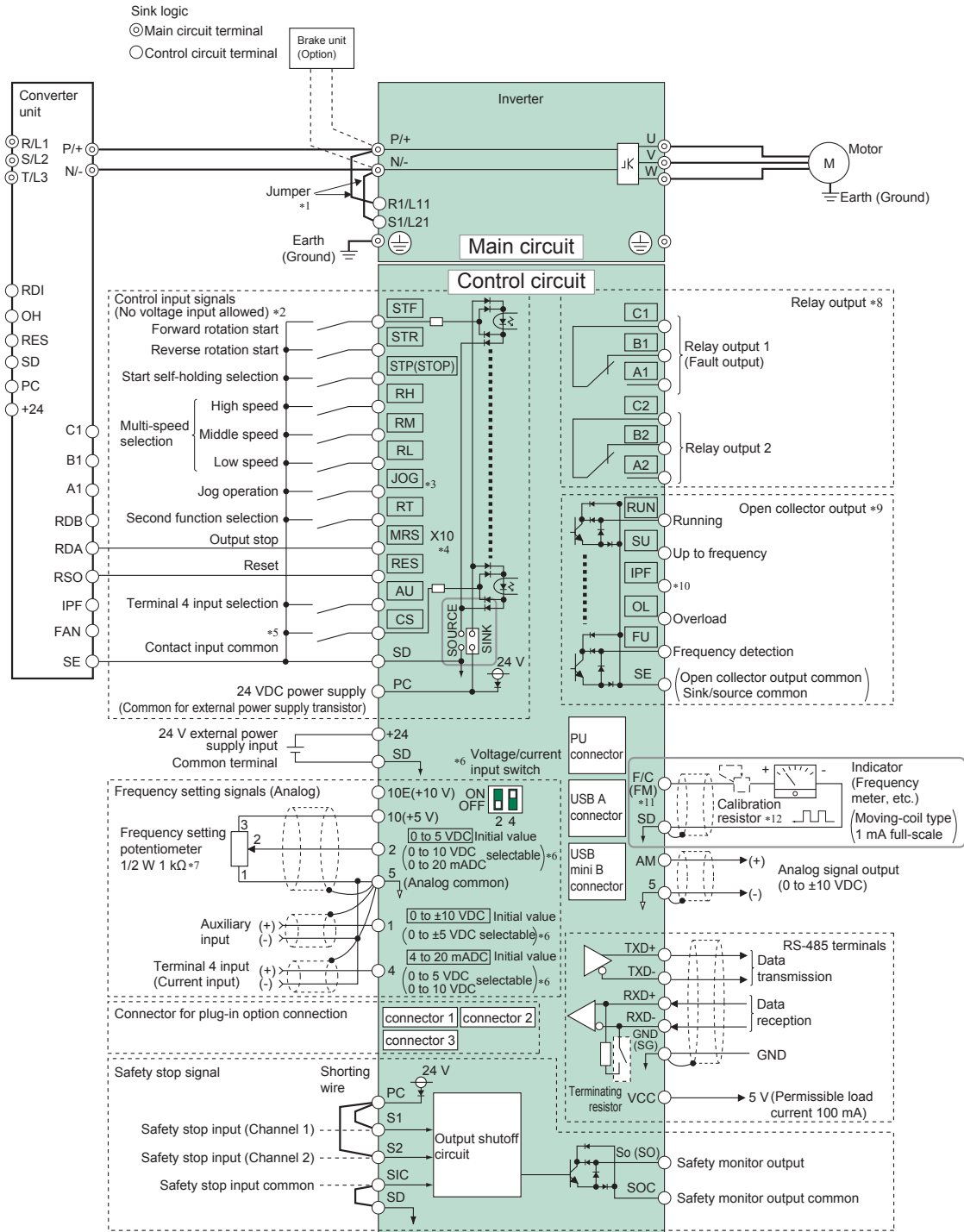

- *1 The terminals R1/L11 and S1/L21 are connected to the terminals P/+ and N/- with a jumper respectively. When using separate power supply for the control circuit, remove the jumpers from R1/L11 and S1/L21.
- *2 The function of these terminals can be changed with the input terminal assignment (Pr.178 to Pr.189).
- *3 Terminal JOG is also used as the pulse train input terminal. Use Pr.291 to choose JOG or pulse.
- *4 The X10 signal (NC contact input specification) is assigned to the terminal MRS in the initial setting. Set Pr.599 = "0" to change the input specification of the X10 signal to NO contact.
- *5 No function is assigned in the initial setting. Use Pr.186 for function assignment.
- *6 Terminal input specifications can be changed by analog input specification switchover (Pr.73, Pr.267). To input a voltage, set the voltage/current input switch OFF. To input a current, set the voltage/current input switch ON. Terminals 10 and 2 are also used as a PTC input terminal. (Pr.561)
- *7 It is recommended to use 2 W 1 kΩ when the frequency setting signal is changed frequently.
- *8 The function of these terminals can be changed with the output terminal assignment (Pr.195, Pr.196).
- *9 The function of these terminals can be changed with the output terminal assignment (Pr.190 to Pr.194).
- *10 No function is assigned in the initial setting. Use Pr.192 for function assignment.
- *11 The terminal F/C (FM) can be used to output pulse trains as open collector output by setting Pr.291.
- *12 Not required when calibrating the scale with the operation panel.

● Converter unit (FR-CC2)

◆ When the sink logic is selected

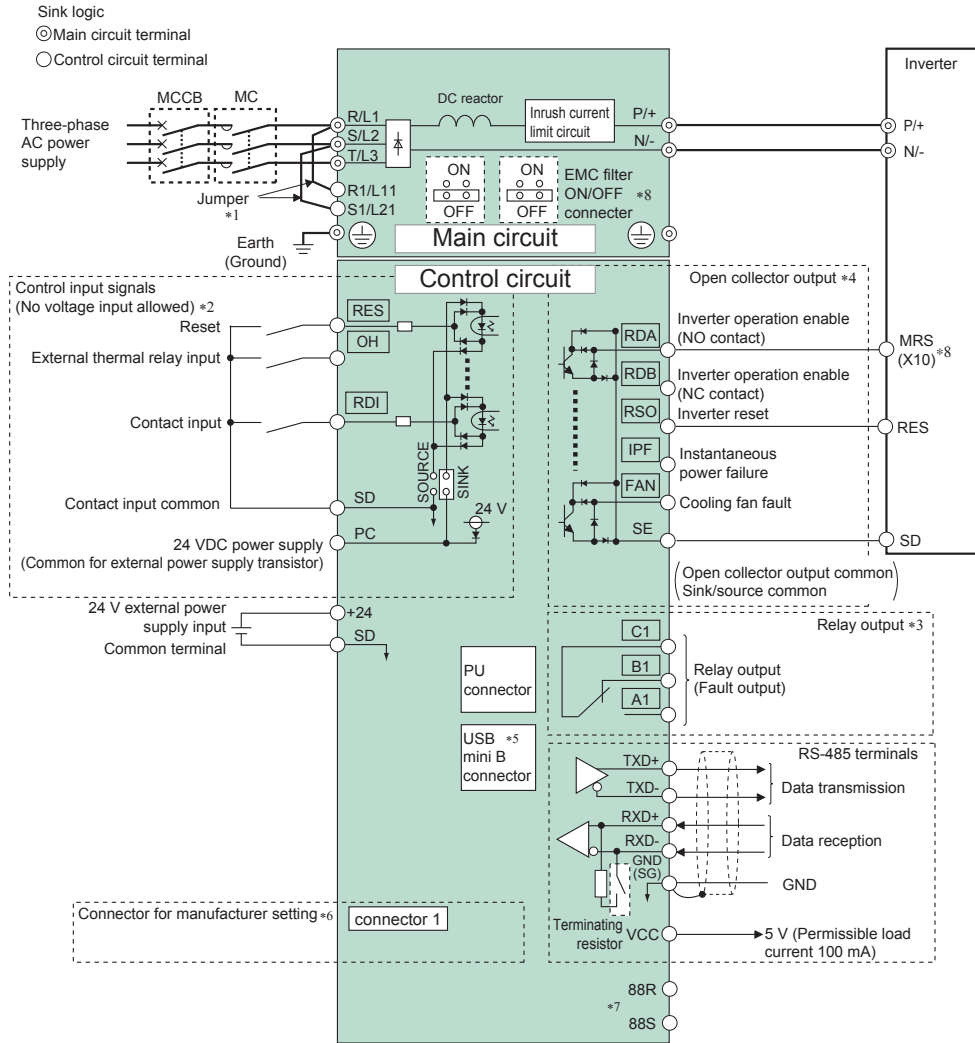

◆ For a 12-phase application

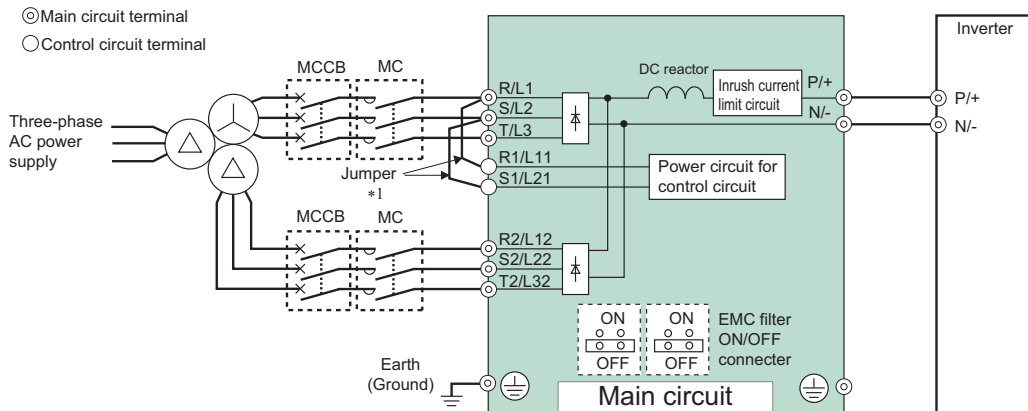

- *1 When using separate power supply for the control circuit, remove the jumpers from R1/L11 and S1/L21.
- *2 The function of these terminals can be changed with the input terminal assignment (Pr.178, Pr.187, Pr.189).
- *3 The function of these terminals can be changed with the output terminal assignment (Pr.195).
- *4 The function of these terminals can be changed with the output terminal assignment (Pr.190 to Pr.194).
- *5 The connector is for manufacturer setting. Do not use.
- *6 Plug-in options cannot be used.
- *7 For manufacturer setting. Do not use.
- *8 To use RDA signal of the converter unit, select the NC contact input specification for the input logic of MRS signal or X10 signal of the inverter. To use RDB signal of the converter unit, select the NO contact input specification for the input logic of MRS signal or X10 signal of the inverter. (For changing the input logic, refer to the Instruction Manual of the inverter.)

● Standard models and IP55 compatible models (FR-F800-E)

◆ FM type

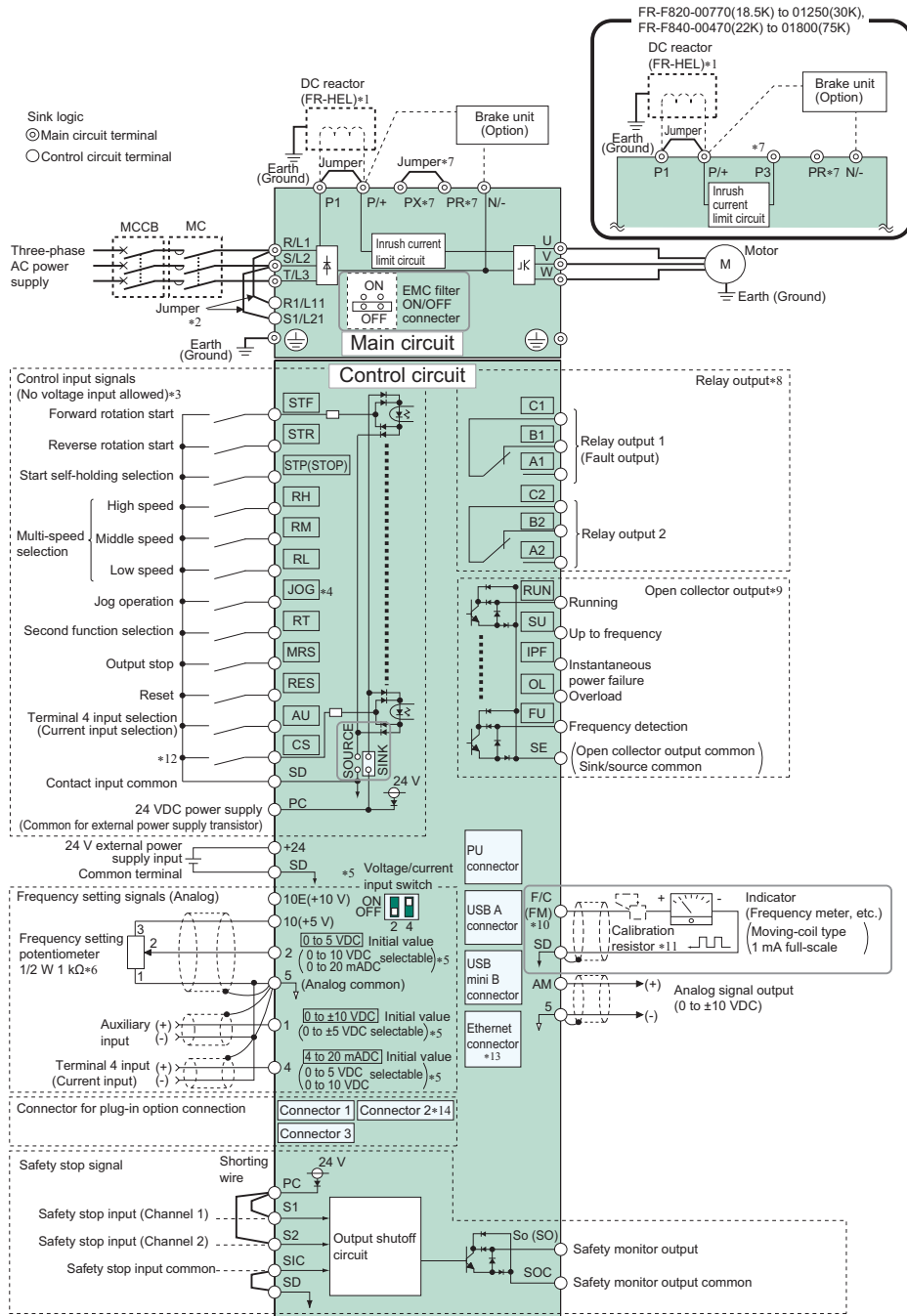

- *1 For the FR-F820-03160(75K) or higher, the FR-F840-01800(75K) or higher, always connect a DC reactor (FR-HEL), which is available as an option. (To select a DC reactor, refer to **page 21**, **page 124**, and select one according to the applicable motor capacity.) When connecting a DC reactor, if a jumper is installed across terminals P1 and P/+, remove the jumper before installing the DC reactor. The IP55 compatible model is equipped with a DC reactor. (A jumper is not installed in the FR-F820-03160(75K) or higher and the FR-F840-01800(75K) or higher.)
- *2 When using separate power supply for the control circuit, remove the jumper between R1/L11 and S1/L21. The IP55 compatible model does not have terminals R1/L11 and S1/L21, and a jumper.
- *3 The function of these terminals can be changed with the input terminal assignment (**Pr.178 to Pr.189**). (Refer to **page 18**.)
- *4 Terminal JOG is also used as the pulse train input terminal. Use **Pr.291** to choose JOG or pulse.
- *5 Terminal input specifications can be changed by analog input specification switchover (**Pr.73**, **Pr.267**). To input a voltage, set the voltage/current input switch OFF. To input a current, set the voltage/current input switch ON. Terminals 10 and 2 are also used as a PTC input terminal. (**Pr.561**) (Refer to the FR-F800 Instruction Manual (Detailed).)
- *6 It is recommended to use 2 W 1 k Ω when the frequency setting signal is changed frequently.
- *7 Do not use terminals PR, PX, and P3. The jumper may or may not be attached depending on the inverter. (Refer to the Instruction Manual (Startup).) The IP55 compatible model does not have terminals PR, PX, and P3, and a jumper.
- *8 The function of these terminals can be changed with the output terminal assignment (**Pr.195**, **Pr.196**).
- *9 The function of these terminals can be changed with the output terminal assignment (**Pr.190 to Pr.194**).
- *10 Terminal F/C (FM) can be used to output pulse trains as open collector output by setting **Pr.291**.
- *11 Not required when calibrating the scale with the operation panel.
- *12 No function is assigned in the initial status. Assign the function using **Pr.186 CS terminal function selection**.
- *13 The option connector 2 cannot be used because the Ethernet board is installed in the initial status. The Ethernet board must be removed to install a plug-in option to the option connector 2. (However, Ethernet communication is disabled in that case.)
- *14 For the inverter with a built-in C2 filter (IP55 compatible model), do not change the initially set ON (enabled) position of the EMC filter ON/OFF connector. The Class C2 compatibility condition is not satisfied with the EMC filter OFF. The FR-F846-00250(11K)-C2 to FR-F846-00470(22K)-C2 are not equipped with an EMC filter ON/OFF connector. The EMC filter is always ON.

◆ CA type

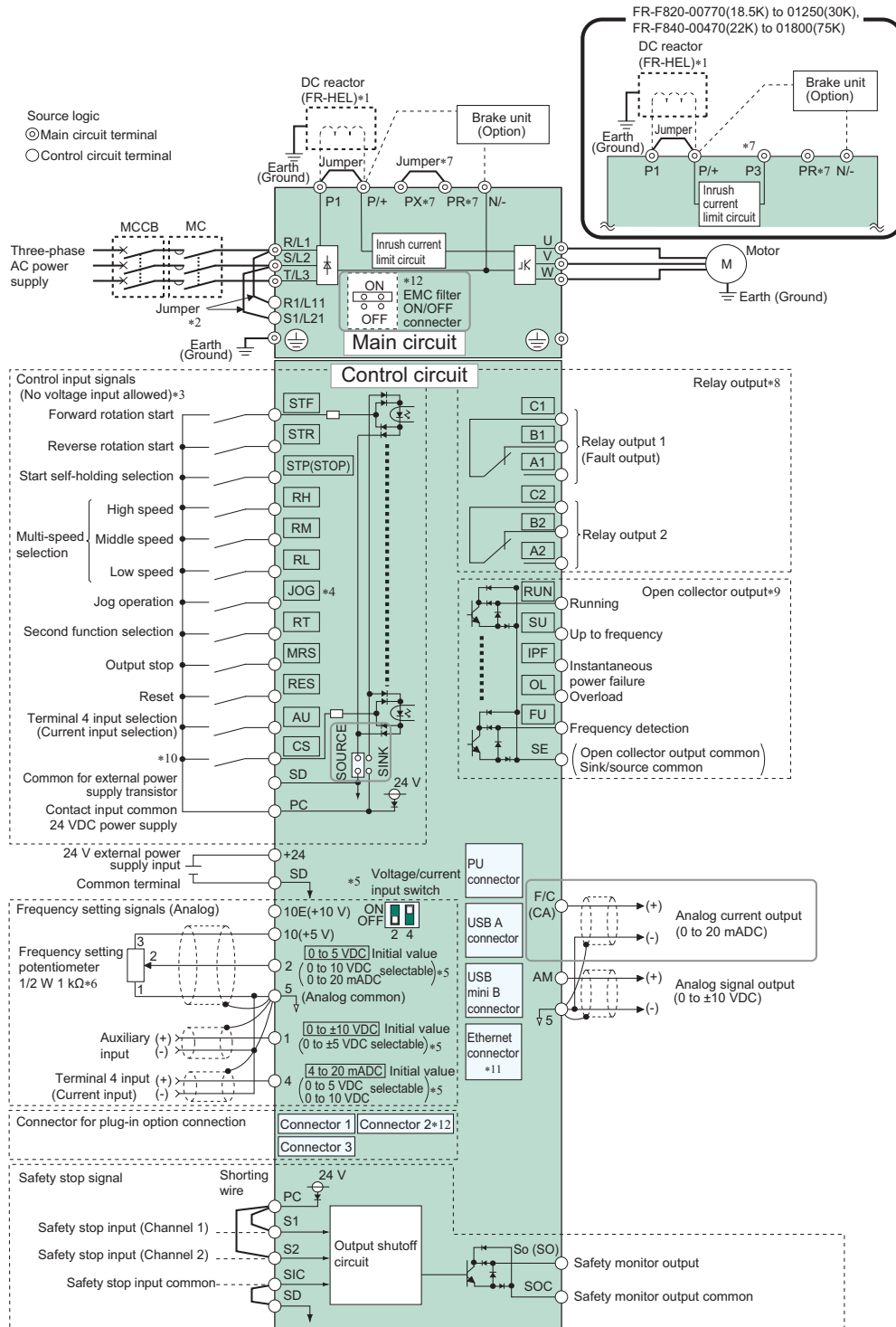

- *1 For the FR-F820-03160(75K) or higher, the FR-F840-01800(75K) or higher, always connect a DC reactor (FR-HEL), which is available as an option. (To select a DC reactor, refer to **page 21**, **page 124**, and select one according to the applicable motor capacity.) When connecting a DC reactor, if a jumper is installed across terminals P1 and P/+, remove the jumper before installing the DC reactor. The IP55 compatible model is equipped with a DC reactor. (A jumper is not installed in the FR-F820-03160(75K) or higher and the FR-F840-01800(75K) or higher.)
- *2 When using separate power supply for the control circuit, remove the jumper between R1/L11 and S1/L21. The IP55 compatible model does not have terminals R1/L11 and S1/L21, and a jumper.
- *3 The function of these terminals can be changed with the input terminal assignment (**Pr.178 to Pr.189**).
- *4 Terminal JOG is also used as the pulse train input terminal. Use **Pr.291** to choose JOG or pulse.
- *5 Terminal input specifications can be changed by analog input specification switchover (**Pr.73**, **Pr.267**). To input a voltage, set the voltage/current input switch OFF. To input a current, set the voltage/current input switch ON. Terminals 10 and 2 are also used as a PTC input terminal. (**Pr.561**)
- *6 It is recommended to use 2 W 1 kΩ when the frequency setting signal is changed frequently.
- *7 Do not use terminals PR, PX, and P3. The jumper may or may not be attached depending on the inverter. (Refer to the Instruction Manual (Startup).) The IP55 compatible model does not have terminals PR, PX, and P3, and a jumper.
- *8 The function of these terminals can be changed with the output terminal assignment (**Pr.195**, **Pr.196**).
- *9 The function of these terminals can be changed with the output terminal assignment (**Pr.190 to Pr.194**).
- *10 No function is assigned in the initial status. Assign the function using **Pr.186 CS terminal function selection**.
- *11 The option connector 2 cannot be used because the Ethernet board is installed in the initial status. The Ethernet board must be removed to install a plug-in option to the option connector 2. (However, Ethernet communication is disabled in that case.)
- *12 For the inverter with a built-in C2 filter (IP55 compatible model), do not change the initially set ON (enabled) position of the EMC filter ON/OFF connector. The Class C2 compatibility condition is not satisfied with the EMC filter OFF. The FR-F846-00250(11K)-C2 to FR-F846-00470(22K)-C2 are not equipped with an EMC filter ON/OFF connector. The EMC filter is always ON.

Terminal Specifications

● Inverter

■ indicates that terminal functions can be selected from Pr.178 to Pr.196 (I/O terminal function selection).

Terminal names and terminal functions are those of the factory set.

Type	Terminal symbol	Common	Terminal name	Description		
Main circuit	R/L1, S/L2, T/L3 *1	—	AC power input	Connect to the commercial power supply.		
	U, V, W	—	Inverter output	Connect a three-phase squirrel-cage motor or PM motor.		
	R1/L11, S1/L21 *2	—	Power supply for control circuit	Connected to the AC power supply terminals R/L1 and S/L2. To retain alarm display and alarm output, apply external power to this terminal.		
	P/+, N/-	—	Brake unit connection	Connect the brake unit (FR-BU2), power regeneration common converter (FR-CV), power regeneration converter (MT-RC), high power factor converter (FR-HC2), multifunction regeneration converter (FR-XC), or DC power supply (under DC feeding mode).		
	P/+, P1 *1	—	DC reactor connection	Remove the jumper across terminals P/+P1 and connect a DC reactor. For the FR-F820-03160(75K) or higher, the FR-F840-01800(75K) or higher, always connect a DC reactor, which is available as an option. (A jumper is not installed in the FR-F820-03160(75K) or higher and the FR-F840-01800(75K) or higher.)		
	PR, PX, P3 *1 *2	—		Do not use terminals PX, PR, and P3. Terminal PX is equipped in the FR-F820-00490(11K) or lower and the FR-F840-00250(11K) or lower. Terminal PR is equipped in the FR-F820-01250(30K) or lower and the FR-F840-01800(75K) or lower. Terminal P3 is equipped in the FR-F820-00770(18.5K) to 01540(37K) and the FR-F840-00470(22K) to 01800(75K).		
		—	Earth (Ground)	For earthing (grounding) the inverter chassis. Must be earthed (grounded).		
Control circuit/input signal	Contact input	SD (sink (negative common)) PC (source (positive common))	STF	Forward rotation start	Turn ON the STF signal to start forward rotation and turn it OFF to stop.	When the STF and STR signals are turned ON simultaneously, the stop command is given.
			STR	Reverse rotation start	Turn ON the STR signal to start reverse rotation and turn it OFF to stop.	
			STP (STOP)	Start self-holding selection	Turn ON the STOP signal to self-hold the start signal.	
			RH, RM, RL	Multi-speed selection	Multi-speed can be selected according to the combination of RH, RM and RL signals.	
			JOG	Jog mode selection	Turn ON the JOG signal to select Jog operation (initial setting) and turn ON the start signal (STF or STR) to start Jog operation.	
			RT	Second function selection	JOG terminal can be used as pulse train input terminal. To use as pulse train input terminal, the Pr.291 setting needs to be changed. (maximum input pulse: 100k pulses/s)	
			MRS	Output stop	Turn ON the MRS signal (2 ms or more) to stop the inverter output. Use to shut OFF the inverter output when stopping the motor by electromagnetic brake.	
			MRS (X10) *8	Output stop (Inverter operation enable)	Connect to the terminal RDA of the converter unit (FR-CC2). When the RDA signal is turned OFF, the inverter output is shut off. The X10 signal (NC contact) is assigned to the terminal MRS in the initial setting. Use Pr.599 to change the specification to NO contact.	
			RES	Reset	Used to reset alarm output provided when protective circuit is activated. Turn ON the RES signal for more than 0.1 s, then turn it OFF. Recover about 1 s after reset is cancelled.	
			AU	Terminal 4 input selection	Terminal 4 is made valid only when the AU signal is turned ON. Turning the AU signal ON makes terminal 2 invalid.	
			CS	No function	Use Pr.186 CS terminal function selection for function assignment.	
	Frequency setting	10E	5	Frequency setting power supply	When connecting a frequency setting potentiometer at an initial status, connect it to terminal 10.	10 VDC ±0.4 V, permissible load current 10 mA
		10	5		Change the input specifications of terminal 2 when connecting it to terminal 10E.	5 VDC ±0.5 V, permissible load current 10 mA
2		5	Frequency setting (voltage)	Inputting 0 to 5 VDC (or 0 to 10 V, 4 to 20 mA) provides the maximum output frequency at 5 V (10 V, 20 mA) and makes input and output proportional. Use Pr.73 to switch from among input 0 to 5 VDC (initial setting), 0 to 10 VDC, and 4 to 20 mA. Set the voltage/current input switch in the ON position to select current input (0 to 20 mA).	Voltage input: Input resistance 10 kΩ to 11 kΩ Maximum permissible voltage 20 VDC Current input: Input resistance 245 Ω ± 5 Ω Maximum permissible current 30 mA	
4		5	Frequency setting (current)	Inputting 4 to 20 mADC (or 0 to 5 V, 0 to 10 V) provides the maximum output frequency at 20 mA and makes input and output proportional. This input signal is valid only when the AU signal is on (terminal 2 input is invalid). Use Pr.267 to switch from among input 4 to 20 mA (initial setting), 0 to 5 VDC, and 0 to 10 VDC. Set the voltage/current input switch in the OFF position to select voltage input (0 to 5 V/0 to 10 V). Use Pr.858 to switch terminal functions.		
Thermistor	1	5	Frequency setting auxiliary	Inputting 0 to ±5 VDC or 0 to ±10 VDC adds this signal to terminal 2 or 4 frequency setting signal. Use Pr.73 to switch between input 0 to ±5 VDC and 0 to ±10 VDC (initial setting) input.	Input resistance 10 kΩ to 11 kΩ Maximum permissible voltage ±20 VDC	
	10 2	—	PTC thermistor input	For receiving PTC thermistor outputs. When PTC thermistor is valid (Pr.561 ≠ "9999"), the terminal 2 is not available for frequency setting.	Applicable PTC thermistor specification Overheat detection resistance:500 Ω to 30 kΩ (Set by Pr.561)	
External power supply input	+24	SD	24 V external power supply input	For connecting a 24 V external power supply. If a 24 V external power supply is connected, power is supplied to the control circuit while the main power circuit is OFF.	Input voltage 23 to 25.5 VDC Input current 1.4 A or less	

Type	Terminal symbol	Common	Terminal name	Description	
Control circuit/output signal	Relay	—	Relay output 1 (alarm output)	1 changeover contact output indicates that the inverter protective function has activated and the output stopped. Alarm: discontinuity across B-C (continuity across A-C), Normal: continuity across B-C (discontinuity across A-C)	
			Relay output 2	1 changeover contact output	
	Open collector	SE	SE	Inverter running	Switched low when the inverter output frequency is equal to or higher than the starting frequency (initial value 0.5 Hz). Switched high during stop or DC injection brake operation.
				Up to frequency	Switched low when the output frequency reaches within the range of $\pm 10\%$ (initial value) of the set frequency. Switched high during acceleration/ deceleration and at a stop.
				Overload alarm	Switched low when stall prevention is activated by the stall prevention function. Switched high when stall prevention is cancelled.
				Instantaneous power failure	Switched low when an instantaneous power failure and under voltage protections are activated.
				Open collector output	No function is assigned in the initial setting. The function can be assigned setting Pr.192 .
				Frequency detection	Switched low when the inverter output frequency is equal to or higher than the preset detected frequency and high when less than the preset detected frequency.
	Pulse	SD	SD	For meter	Output item: output frequency (initial setting), permissible load current 2 mA, For full scale 1440 pulses/s Signals can be output from the open collector terminals by setting Pr.291 . (maximum output pulse: 50k pulses/s)
				NPN open collector output	
	Analog	5	5	Analog voltage output	Output item: output frequency (initial setting), output signal 0 to ± 10 VDC, permissible load current 1 mA (load impedance 10 k Ω or more), resolution 13 bits
				Analog current output	
	Safety stop signal	S1	SIC	Safety stop input (Channel 1)	The terminals S1 and S2 are used for the safety stop input signal for the safety relay module. The terminals S1 and S2 are used at the same time (dual channel). Inverter output is shutdown by shortening/opening between terminals S1 and SIC, or between S2 and SIC.
S2		SIC	Safety stop input (Channel 2)	In the initial status, terminals S1 and S2 are shorted with the terminal PC by shorting wires. The terminal SIC is shorted with the terminal SD. Remove the shorting wires and connect the safety relay module when using the safety stop function.	
So (SO)		SOC	Safety monitor output (open collector output)	Indicates the safety stop input signal status. Switched to LOW when the status is other than the internal safety circuit failure. Switched to HIGH during the internal safety circuit failure status. (LOW is when the open collector output transistor is ON (conducted). HIGH is when the transistor is OFF (not conducted).) Refer to the Safety stop function instruction manual (BCN-A23228-001) when the signal is switched to HIGH while both terminals S1 and S2 are open.	
Common terminal	SD	—	Contact input common (sink) ^{*4}	Common terminal for the contact input terminal (sink logic) and terminal FM.	
			External transistor common (source) ^{*5}	Connect this terminal to the power supply common terminal of a transistor output (open collector output) device, such as a programmable controller, in the source logic to avoid malfunction by undesirable current.	
			24 VDC power supply common	Common output terminal for the 24 VDC 0.1 A power supply (terminal PC). Isolated from terminals 5 and SE.	
	PC	—	External transistor common (sink) ^{*4}	Connect this terminal to the power supply common terminal of a transistor output (open collector output) device, such as a programmable controller, in the sink logic to avoid malfunction by undesirable currents.	
			Contact input common (source) ^{*5}	Common terminal for contact input terminal (source logic).	
	5	—	SD	24 VDC power supply	Can be used as a 24 VDC 0.1 A power supply.
	5	—	—	Frequency setting common	Common terminal for frequency setting signal (terminal 2, 1 or 4) and analog output terminal AM, CA. Do not earth (ground).
	SE	—	—	Open collector output common	Common terminal for terminals RUN, SU, OL, IPF, FU
	SIC	—	—	Safety stop input terminal common	Common terminal for terminals S1 and S2.
SOC	—	—	Safety monitor output terminal common	Common terminal for terminal So (SO).	

Type	Terminal symbol	Common	Terminal name	Description
Communication	—	—	PU connector	With the PU connector, communication can be made through RS-485. (1:1 connection only) <ul style="list-style-type: none"> • Conforming standard: EIA-485(RS-485) • Transmission format: Multi-drop link • Communication speed: 4800 to 115200 bps • Wiring length: 500 m
	RS-485 terminals	—	Inverter transmission terminal	With the RS-485 terminals, communication can be made through RS-485. (The FR-F800-E inverter does not have the interface.) <ul style="list-style-type: none"> • Conforming standard: EIA-485(RS-485) • Transmission format: Multi-drop link • Communication speed: 300 to 115200 bps • Overall extension: 500 m
		TXD+, TXD-	Inverter reception terminal	
		RXD+, RXD-	Earth (Ground)	
	—	—	Ethernet connector	Using Ethernet communication, the inverter's status can be monitored or the parameters can be set via Internet. (Only the FR-F800-E inverter has the interface.)
	—	—	USB A connector	A connector (receptacle). A USB memory device enables parameter copies and the trace function.
USB B connector			Mini B connector (receptacle). Connected to a personal computer via USB to enable setting, monitoring, test operations of the inverter by FR Configurator2.	

- *1 Terminals R/L1, S/L2, T/L3, PR, P3, P1, and PX are not provided in the separated converter type.
*2 Terminals R1/L11, S1/L21, PR, P3, and PX are not provided in the IP55 compatible model.
*3 The terminal P3 is equipped in the FR-F820-00770(18.5K) to 01250(30K) and the FR-F840-00470(22K) to 01800(75K).
*4 Sink logic is initially set for the FM-type inverter.
*5 Source logic is initially set for the CA-type inverter.
*6 Terminal FM is provided in the FM-type inverter.
*7 Terminal CA is provided in the CA-type inverter.
*8 Function and name of the separated converter type.

● Converter unit (FR-CC2)

■ indicates that terminal functions can be selected from **Pr.178, Pr.187, Pr.189 to Pr.195 (I/O terminal function selection)**.
Terminal names and terminal functions are those of the factory set.

Type	Terminal symbol	Common	Terminal name	Description		
Main circuit	R/L1, S/L2, T/L3 (R2/L12, S2/L22, T2/L32)	—	AC power input	Connect these terminals to the commercial power supply. For 12-phase applications, use these terminals for connection with a 12-phase rectifier power transformer (3-winding transformer). For details, refer to the Instruction Manual of the converter unit.		
	R1/L11, S1/L21	—	Power supply for the control circuit	Connected to the AC power supply terminals R/L1 and S/L2. To retain the fault display and fault output, remove the jumpers across terminals R/L1 and R1/L11 and across S/L2 and S1/L21 and supply external power to these terminals.		
	P/+, N/-	—	Inverter connection	Connect to terminals P/+ and N/- of the inverter.		
		—	Earth (ground)	For earthing (grounding) the converter unit chassis. This must be earthed (grounded).		
Control circuit/input signal	Contact input	SD (sink (negative common))	Reset	Use this signal to reset a fault output provided when a protective function is activated. Turn ON the RES signal for 0.1 s or longer, then turn it OFF. In the initial setting, reset is always enabled. By setting Pr.75 , reset can be set enabled only at fault occurrence of the converter unit. The inverter recovers about 1 s after the reset is released.		
			External thermal relay input	The external thermal relay input (OH) signal is used when using an external thermal relay or a thermal protector built into the motor to protect the motor from overheating. When the thermal relay is activated, the inverter trips by the external thermal relay operation (E.OHT).		
			Contact input	The function can be assigned by setting Pr.178 .		
External power supply input	+24	SD	24 V external power supply input	For connecting a 24 V external power supply. If a 24 V external power supply is connected, power is supplied to the control circuit while the main power circuit is OFF. Input voltage 23 to 25.5 VDC Input current 1.4 A or less		
			Relay	A1, B1, C1	Relay output 1 (fault output)	1 changeover contact output that indicates that the protective function of the converter unit has been activated and the outputs are stopped. Fault: discontinuity across B and C (continuity across A and C), Normal: continuity across Band C (discontinuity across A and C) Contact capacity 230 VAC 0.3 A (power factor = 0.4) 30 VDC 0.3 A
Control circuit/output signal	Relay	—	88R, 88S	For manufacturer setting. Do not use.		
		Open collector	RDA	SE	Inverter operation enable (NO contact)	Switched to LOW when the converter unit operation is ready. Assign the signal to the terminal MRS (X10) of the inverter. The inverter can be started when the RDA status is LOW. Permissible load 24 VDC (maximum 27 VDC) 0.1 A (The voltage drop is 2.8 V at maximum while the signal is ON.)
	RDB		SE	Inverter operation enable (NC contact)	Switched to LOW when a converter unit fault occurs or the converter is reset. The inverter can be started when the RDB status is HIGH.	
	RSO		SE	Inverter reset	Switched to LOW when the converter is reset (RES-ON). Assign the signal to the terminal RES of the inverter. The inverter is reset when it is connected with the RSO status LOW. LOW is when the open collector output transistor is ON (conducted).	
	IPF		SE	Instantaneous power failure	Switched to LOW when an instantaneous power failure is detected. HIGH is when the transistor is OFF (not conducted).	
	FAN	SE	Cooling fan fault	Switched to LOW when a cooling fan fault occurs.		
Common terminal	SD	—	Contact input common (sink) (Initial setting)	Common terminal for contact input terminal (sink logic).		
		—	External transistor common (source)	Connect this terminal to the power supply common terminal of a transistor output (open collector output) device, such as a programmable controller, in the source logic to avoid malfunction by undesirable current.		
		—	24 VDC power supply common	Common terminal for the 24 VDC power supply (terminal PC, terminal +24) Isolated from terminal SE.		
	PC	—	External transistor common (sink) (Initial setting)	Connect this terminal to the power supply common terminal of a transistor output (open collector output) device, such as a programmable controller, in the source logic to avoid malfunction by undesirable current.		
		—	Contact input common (source)	Common terminal for contact input terminal (source logic).		
		SD	24 VDC power supply	Can be used as a 24 VDC 0.1 A power supply.		
SE	—	Open collector output common	Common terminal for terminals RDA, RDB, RSO, IPF, FAN			
Communication	—	—	PU connector	With the PU connector, communication can be made through RS-485. (For connection on a 1:1 basis only) • Conforming standard: EIA-485 (RS-485) • Transmission format: Multidrop link • Communication speed: 4800 to 115200 bps • Wiring length: 500 m		
	RS-485 terminals	TXD+	—	Converter unit transmission terminal	The RS-485 terminals enable the communication by RS-485. • Conforming standard: EIA-485 (RS-485)	
		TXD-	—	Converter unit reception terminal	• Transmission format: Multidrop link	
		RXD+	—		• Communication speed: 300 to 115200 bps	
		RXD-	—	• Overall length: 500 m		
GND (SG)	—	Earthing (grounding)				

Operation Panel (FR-DU08(-01))

● Components of the operation panel

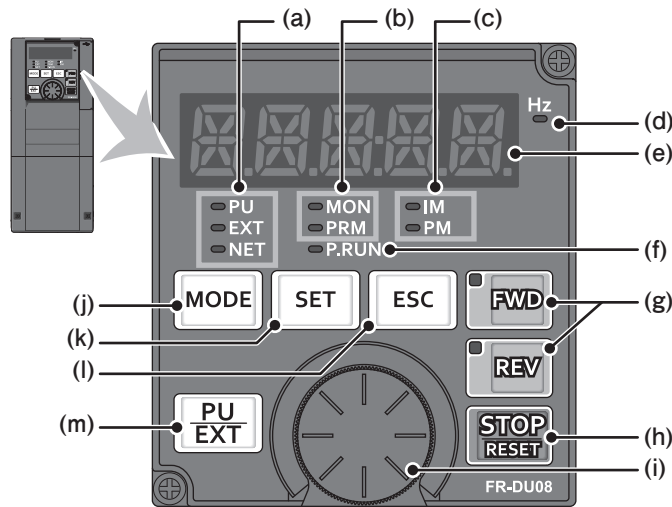

The operation panel of the inverter can be used for the converter unit.

No.	Component ^{*1}	Name	Description
(a)	FR-DU08 	Operation mode indicator ^{*2}	PU/HAND: ON when the inverter is in the PU operation mode. EXT/AUTO: ON when the inverter is in the External operation mode. (ON when the inverter in the initial setting is powered ON.) NET: ON when the inverter is in the Network operation mode. PU and EXT: ON when the inverter is in the External/PU combined operation mode 1 or 2.
	FR-DU08-01 		
(b)		Operation panel status indicator	MON: ON when the operation panel is in the monitoring mode. Quickly blinks twice intermittently while the protective function is activated. PRM: ON when the operation panel is in the parameter setting mode.
(c)		Control motor indicator ^{*2}	IM: ON when the inverter is set to control the induction motor. PM: ON when the inverter is set to control the PM motor. The indicator blinks during test operation.
(d)		Frequency unit indicator ^{*2}	ON when the actual frequency is monitored. (Blinks when the set frequency is monitored.)
(e)		Monitor (5-digit LED)	Shows a numeric value (readout) of a monitor item such as the frequency or a parameter number. (The monitor item can be changed according to the settings of Pr.52, Pr.774 to Pr.776.)
(f)		PLC function indicator ^{*2}	ON when the PLC function of the inverter is valid.
(g)		FWD key, REV key ^{*2}	FWD key: Starts forward rotation operation. Its LED is ON during forward operation. REV key: Starts reverse rotation operation. Its LED is ON during reverse operation. Either LED blinks under the following conditions.
			<ul style="list-style-type: none"> When the frequency command is not given even if the forward/reverse command is given. When the frequency command is equal to the starting frequency or lower. When the MRS signal is being input.
(h)		STOP/RESET key	Stops the operation commands. Used to reset the inverter when the protection function is activated.
(i)		Setting dial	The setting dial of the Mitsubishi Electric inverters. Turn the setting dial to change the setting of frequency or parameter, etc. Press the setting dial to perform the following operations: <ul style="list-style-type: none"> To display a set frequency in the monitoring mode (The monitor item shown on the display can be changed by using Pr.992.) To display the present setting during calibration To display a fault history number in the fault history mode
(j)		MODE key	Switches the operation panel to a different mode. The easy setting of the inverter operation mode is enabled by pressing this key simultaneously with .
(k)		SET key	Confirms each selection. When this key is pressed during inverter operation, the monitor item changes. (The monitor item can be changed according to the settings of Pr.52, Pr.774 to Pr.776.)
(l)		ESC key	Goes back to the previous display. Holding this key for a longer time changes the display back to the monitor mode.
(m)	FR-DU08 	PU/EXT key ^{*2}	Switches between the PU operation mode, the PUJOG operation mode, and the External operation mode. The easy setting of the inverter operation mode is enabled by pressing this key simultaneously with . Also cancels the PU stop warning.
	FR-DU08-01 		

*1 FR-DU08-01 is the operation panel for the IP55 compatible model.

*2 Not available for the converter unit.

● Basic operation (FR-DU08)

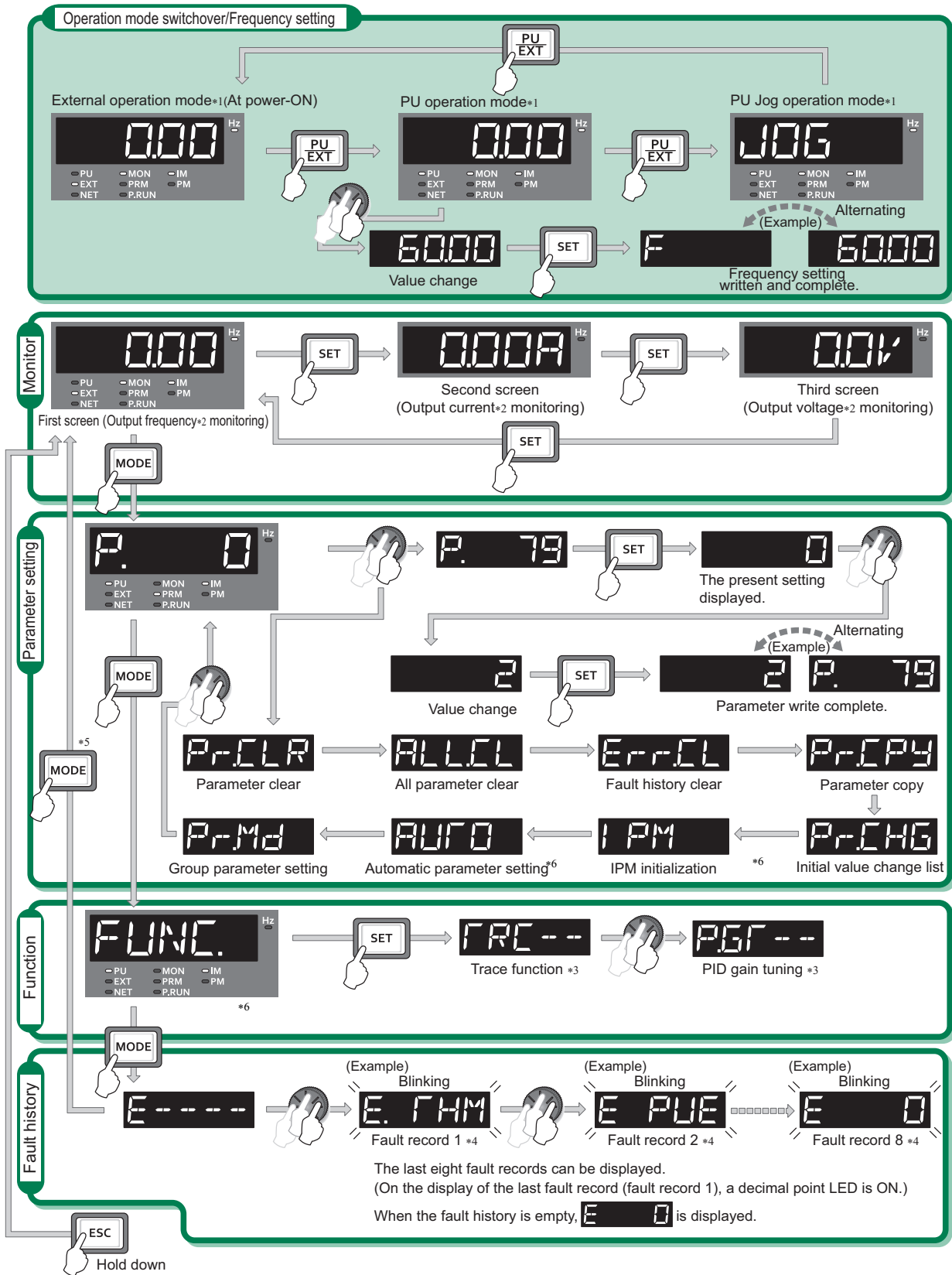

*1 For the details of operation modes, refer to **page 54**.

*2 The monitor items can be changed.

*3 For the details, refer to the Instruction Manual (Detailed).

*4 While a fault record is displayed, the value of the following items recorded at fault occurrence is displayed in the order listed every time **SET** is pressed: Output frequency → Output current → Output voltage → Energization time → Year → Month → Date → Time. (After Time, it goes back to a fault record display.) Pressing the setting dial shows the fault history number.

*5 The USB memory mode indication appears while a USB memory device is connected. (Refer to **page 51**.)

*6 Not available for the converter unit.

● Parameter copy to the USB memory device

Insert the USB memory in the inverter. The USB memory mode is displayed and USB memory operations are possible.

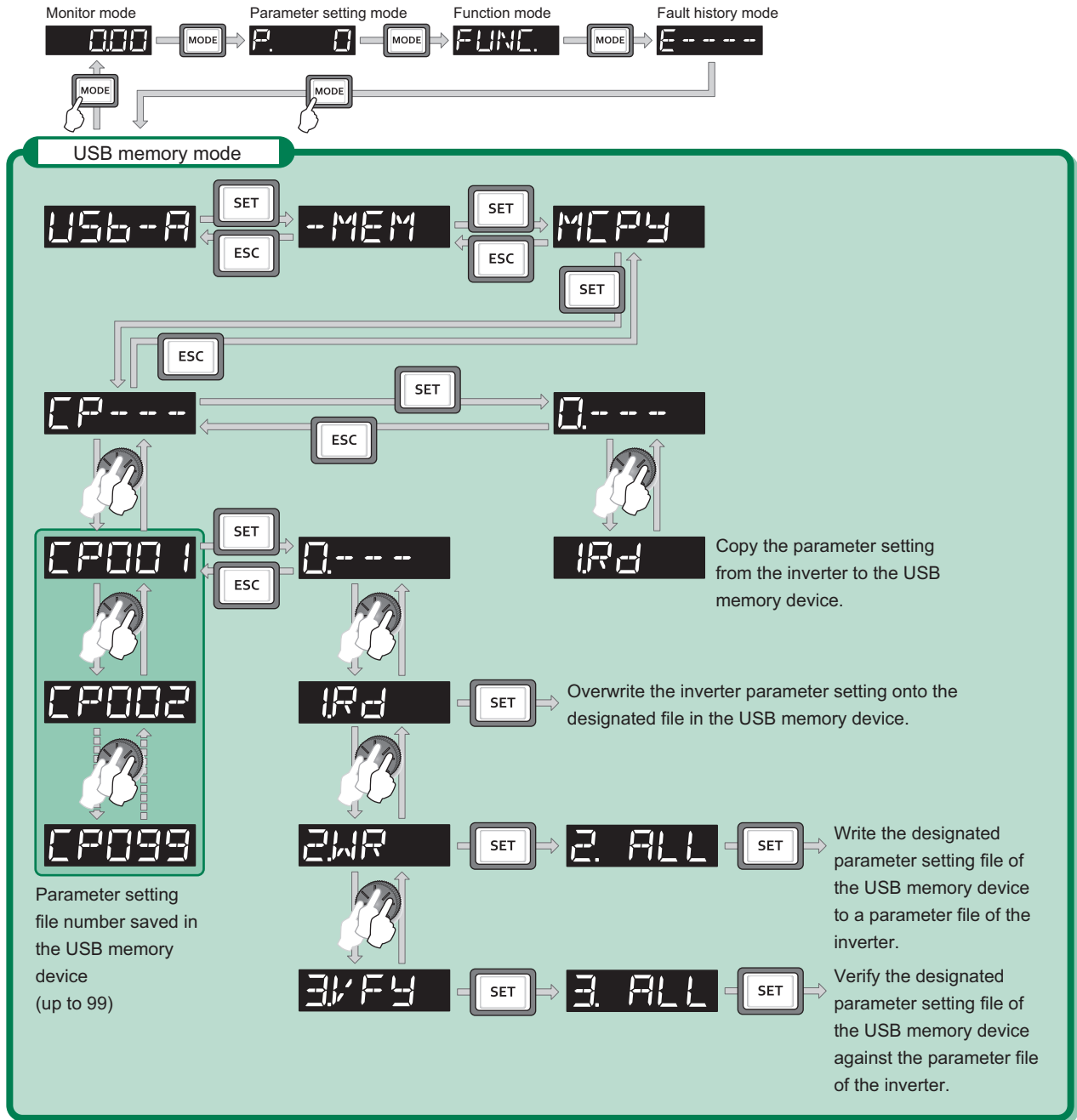



● Group parameter display

Parameter numbers can be changed to grouped parameter numbers.
Parameters are grouped by their functions. The related parameters can be set easily.

(1) Changing to the grouped parameter numbers

Pr.MD setting value	Description
0	No change
1	Parameter display by parameter number
2	Parameter display by function group



Operation

- Screen at power-ON
The monitor display appears.
- Parameter setting mode
Press **MODE** to choose the parameter setting mode. (The parameter number read previously appears.)
- Selecting the parameter number
Turn  until "Pr.Md" (parameter display method) appears.
Press **SET**. "0" (initial value) will appear.
- Changing to the group parameter display
Turn  to change the set value to "2" (group parameter display). Press **SET** to select the group parameter setting. "2" and "Pr.Md" flicker alternately after the setting is completed.

(2) Changing parameter settings in the group parameter display

Changing example Change the P.H400(Pr.1) Maximum frequency.

Operation

- Screen at power-ON
The monitor display appears.
- Changing the operation mode
Press **PU EXT** to choose the PU operation mode. [PU] indicator is lit.
- Parameter setting mode
Press **MODE** to choose the parameter setting mode. (The parameter number read previously appears.)
- Parameter group selection
Press **ESC** several times until "PFD . ." appears.
(No need to press **ESC** if the previously read parameter is one of "Pr.CLR to Pr.Md".) Skip this operation and proceed to step 5.)
- Parameter group selection
Turn  until "PH4 . ." (protective function parameter 4) appears. Press **SET** to display "PH4-- --" and make the group parameters of the protective function parameter 4 selectable.
- Parameter selection
Turn  until "PH400" (P.H400 Maximum frequency) appears. Press **SET** to read the present set value.
"12000" (initial value) appears.
- Changing the setting value
Turn  to change the set value to "6000". Press **SET** to enter the setting. "6000" and "PH400" flicker alternately after the setting is completed.

LCD Operation Panel (FR-LU08(-01))

- The FR-LU08 is an optional operation panel adopting an LCD panel capable of displaying text and menus.
- Replacement with the operation panel (FR-DU08) and installation on the enclosure surface using a connection cable (FR-CB2) are possible. (To connect the FR-LU08, an optional operation panel connection connector (FR-ADP) is required.)
- Parameter settings for up to three inverters can be saved.
- When the FR-LU08 is connected to the inverter, the internal clock of the inverter can be synchronized with the clock of FRLU08. (Real time clock function)

With a battery (CR1216), the FR-LU08 time count continues even if the main power of the inverter is turned OFF. (The time count of the inverter internal clock does not continue when the inverter power is turned OFF.)

- The FR-LU08-01 meets the IP55 rating (except for the PU connector). It can be directly installed to the IP55 compatible model.

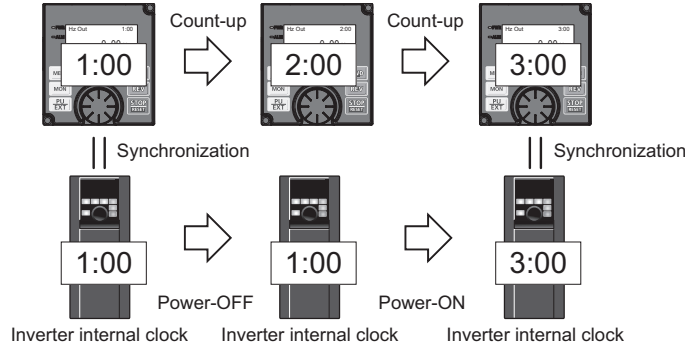

● Appearance and parts name

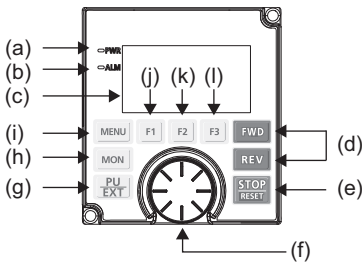

Symbol	Name	Description
a	Power lamp	ON when the power is turned ON.
b	Alarm lamp	ON when an inverter fault occurs.
c	Monitor	Shows a numeric value (readout) of a monitor item such as the frequency or a parameter number. (The monitor item can be changed according to the settings of Pr.52, Pr.774 to Pr.776.)
d	FWD key, REV key	FWD key: Starts the forward rotation operation. REV key: Starts the reverse rotation operation.
e	STOP/RESET key	Stops operation commands. Used to reset the inverter when the protective function is activated.
f	Setting dial	Turn the setting dial to change the setting of frequency or parameter, etc. Press the setting dial to display a fault history number in the fault history mode.
g	PU/EXT key	Switches between the PU operation mode, the PUJOG operation mode, and the External operation mode.
h	MON key	Shows the first priority monitor screen.
i	MENU key	Displays the quick menu. When this key is pressed while the quick menu is displayed, the function menu is displayed.
j	Software key (F1)	Select a guidance displayed on the monitor.
k	Software key (F2)	
l	Software key (F3)	

● Switching the main monitor data

When Pr.52 Operation panel main monitor selection is set to "0", by pressing $\overline{F1}$ (PREV) or $\overline{F3}$ (NEXT) 6 types of monitor data are displayed in order.

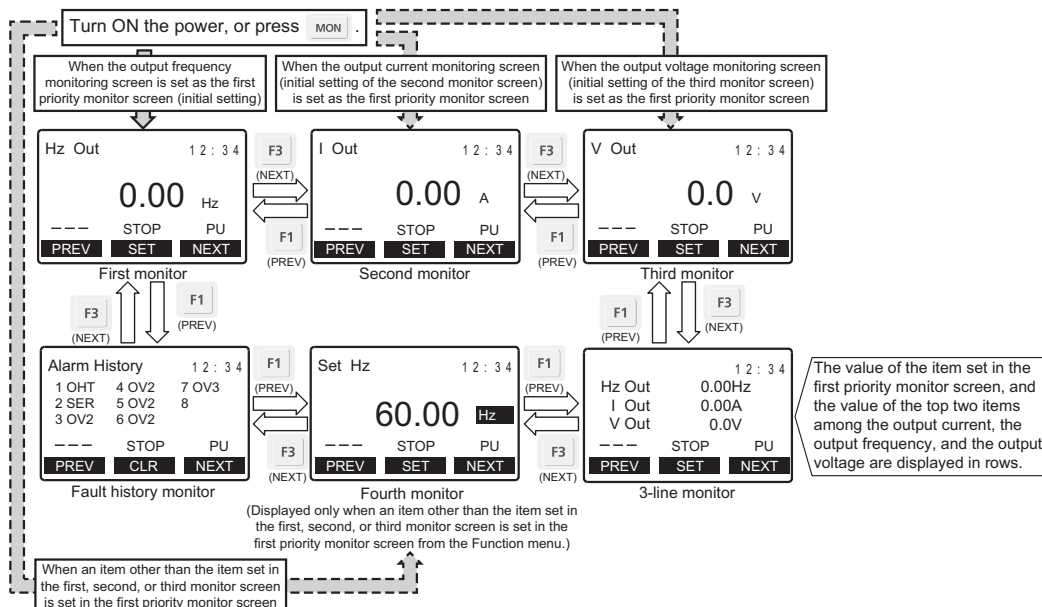

Operation Steps

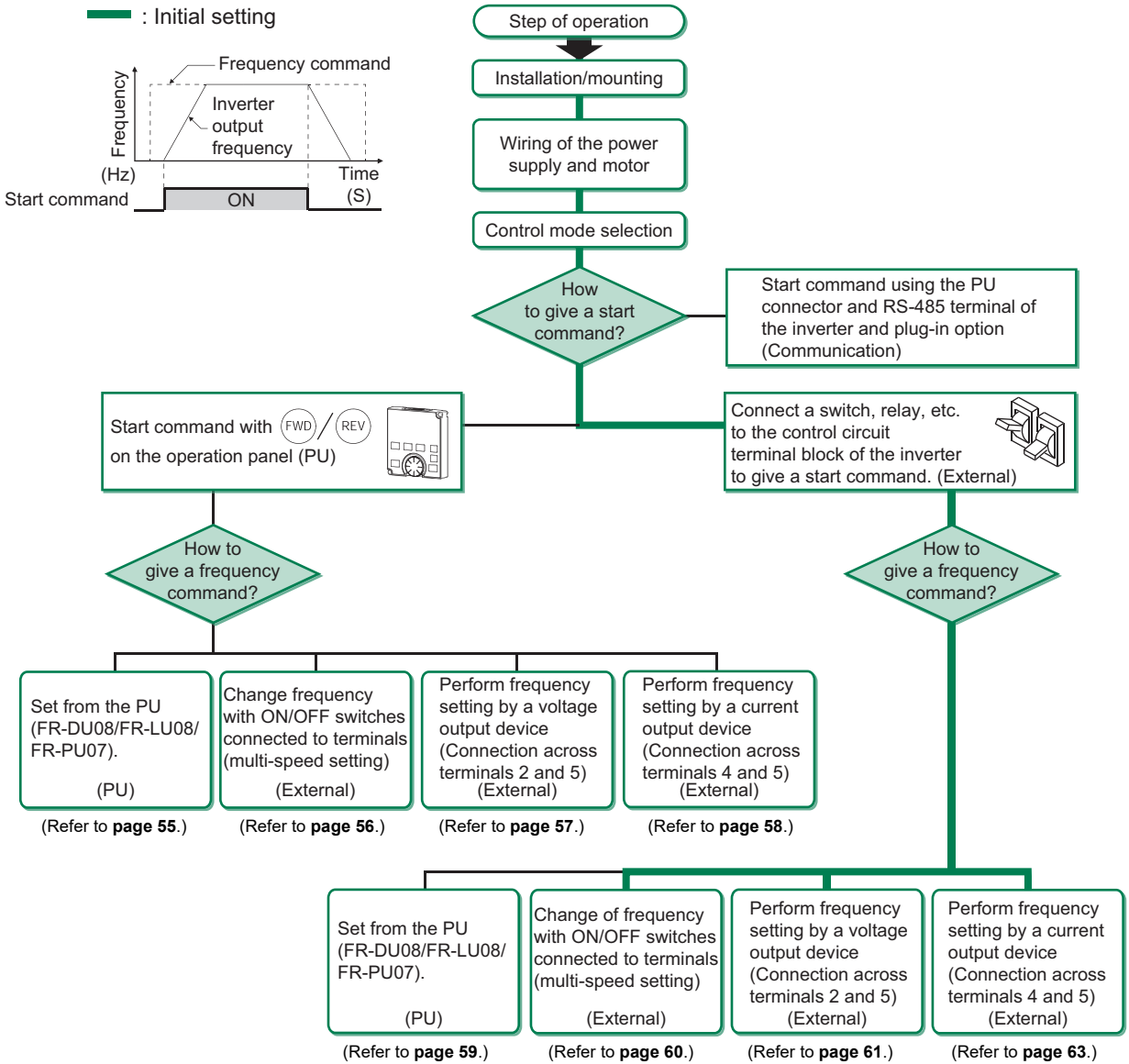

● Basic operation procedure (PU operation)

POINT

- Where is the frequency command source?
 - The frequency set in the frequency setting mode of the operation panel → Refer to **page 55**.
 - The setting dial used as the potentiometer → Refer to **the Instruction Manual (Detailed)**.
 - The ON/OFF switches connected to terminals → Refer to **page 56**.
 - Voltage input signals → Refer to **page 57**.
 - Current input signals → Refer to **page 58**.

◆ Operating at a set frequency (example: operating at 30 Hz)

POINT

- Use the operation panel (FR-DU08) to give a start command and a frequency command. (PU operation)

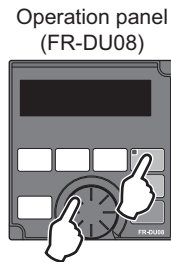

Operation example Operate at 30 Hz.

Operation

1. Screen at power-ON
The monitor display appears.
2. Changing the operation mode
Press **PU EXT** to choose the PU operation mode. [PU] indicator is on.
3. Setting the frequency
Turn until the target frequency, "30.00" (30.00 Hz), appears. The frequency flickers for about 5 s.
While the value is flickering, press **SET** to enter the frequency. "F" and "30.00" flicker alternately. After about 3 s of flickering, the indication goes back to "0.00" (monitor display).
(If **SET** is not pressed, the indication of the value goes back to "0.00" (0.00 Hz) after about 5 s of flickering. In that case, turn again and set the frequency.)
4. Start → acceleration → constant speed
Press **FWD** or **REV** to start running. The frequency value on the indication increases in **Pr.7 Acceleration time**, and "30.00" (30.00 Hz) appears.
(To change the set frequency, perform the operation in above step 3. The previously set frequency appears.)
5. Deceleration → stop
Press **STOP RESET** to stop. The frequency value on the indication decreases in **Pr.8 Deceleration time**, and the motor stops rotating with "0.00" (0.00 Hz) displayed.

NOTE

- To display the set frequency under PU operation mode or External/PU combined operation mode 1 (**Pr.79** = "3"), press .
- (Refer to **the Instruction Manual (Detailed)**.)
- can also be used like a potentiometer to perform operation. (Refer to **the Instruction Manual (Detailed)**.)

◆ Setting the frequency by switches (multi-speed setting)

POINT

- Use the operation panel (FR-DU08) (**FWD** or **REV**) to give a start command.
- Turn ON the RH, RM, or RL signal to give a frequency command. (multi-speed setting)
- Set **Pr.79 Operation mode selection** = "4" (External/PU combination operation mode 2).

[Connection diagram]

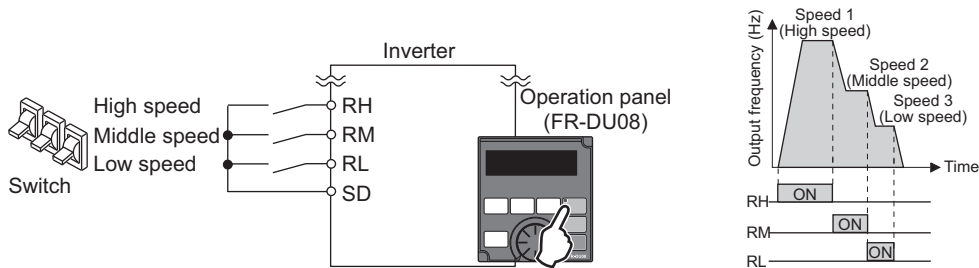

Operation example Operate at a low-speed (10 Hz).

Operation



- 1. Screen at power-ON**
The monitor display appears.
- 2. Changing the operation mode**
Set "4" in **Pr.79**. [PU] and [EXT] indicators are on. (For setting value change, refer to **page 50**.)
- 3. Setting the frequency**
Turn ON the low-speed switch (RL).
- Start → acceleration → constant speed**
Press **FWD** or **REV** to start running. The frequency value on the indication increases in **Pr.7 Acceleration time**, and "10.00" (10.00 Hz) appears.
- Deceleration → stop**
Press **STOP/RESET** to stop. The frequency value on the indication decreases in **Pr.8 Deceleration time**, and the motor stops rotating with "0.00" (0.00 Hz) displayed. Turn OFF the low-speed switch (RL).

NOTE

- The terminal RH is initially set to 60 Hz for the FM type inverter, and to 50 Hz for the CA type inverter. The terminal RM is set to 30 Hz, and the RL is set to 10 Hz. (To change, set **Pr.4**, **Pr.5**, and **Pr.6**.)
- In the initial setting, when two or more of multi-speed settings are simultaneously selected, priority is given to the set frequency of the lower signal.
For example, when RH and RM signals turn ON, RM signal (**Pr.5**) has a higher priority.
- Maximum of 15-speed operation can be performed.

◆ Setting the frequency with analog signals (voltage input)

POINT

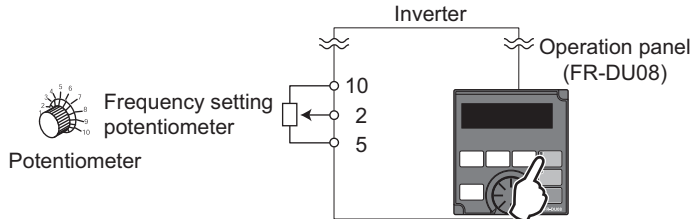

- Use the operation panel (FR-DU08) ( or ) to give a start command.
- Use the potentiometer (frequency setting potentiometer) to give a frequency command (by connecting it across terminals 2 and 5 (voltage input)).
- Set **Pr.79 Operation mode selection** = "4" (External/PU combination operation mode 2).

[Connection diagram] (The inverter supplies 5 V power to the frequency setting potentiometer (terminal 10).)



Operation example Operate at 60 Hz.

Operation



1. **Screen at power-ON**
The monitor display appears.
2. **Changing the operation mode**
Set "4" in **Pr.79**. [PU] and [EXT] indicators are on. (For setting value change, refer to **page 50**.)
3. **Start**
Press  or . [FWD] or [REV] flickers as no frequency command is given.
4. **Acceleration → constant speed**
Turn the potentiometer (frequency setting potentiometer) clockwise slowly to full. The frequency value on the indication increases in **Pr.7 Acceleration time**, and "60.00" (60.00 Hz) appears.
5. **Deceleration**
Turn the potentiometer (frequency setting potentiometer) counterclockwise slowly to full. The frequency value on the indication decreases in **Pr.8 Deceleration time**, and the motor stops rotating with "0.00" (0.00 Hz) displayed. [FWD] or [REV] indicator flickers.
6. **Stop**
Press . [FWD] or [REV] indicator turns OFF.

NOTE

- To change the frequency (60 Hz) at the maximum voltage input (initial value 5 V), adjust **Pr.125 Terminal 2 frequency setting gain frequency**.
- To change the frequency (0 Hz) at the minimum voltage input (initial value 0 V), adjust the **calibration parameter C2 Terminal 2 frequency setting bias frequency**.
- When terminal 10 is used, the maximum output frequency may fluctuate in a range of ± 6 Hz due to fluctuations in the output voltage (5 ± 0.5 VDC). Use **Pr.125** or **Pr.C4** to adjust the output frequency at the maximum analog input as required.
- When terminal 10E is used, the maximum output frequency may fluctuate (in a range of ± 2 to 3 Hz) due to fluctuations in the output voltage (10 ± 0.4 VDC). Use **Pr.125** or **Pr.C4** to adjust the output frequency at the maximum analog input as required.

◆ Using an analog signal (current input) to give a frequency command

POINT

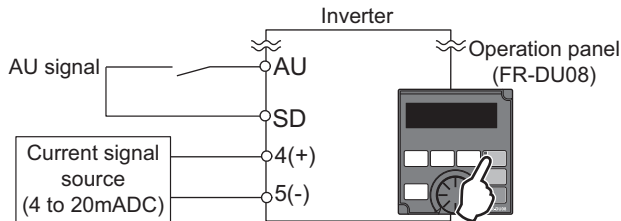

- Use the operation panel (FR-DU08) ( or ) to give a start command.
- Use the outputs from the current signal source (4 to 20 mA) to give a frequency command (by connecting it across terminals 4 and 5 (current input)).
- Turn ON the AU signal.
- Set **Pr.79 Operation mode selection** = "4" (External/PU combination operation mode 2).

[Connection diagram]



Operation example Operate at 60 Hz.

Operation

- 1. Screen at power-ON**
The monitor display appears.
- 2. Changing the operation mode**
Set "4" in **Pr.79**. [PU] and [EXT] indicators are on. (For setting value change, refer to **page 50**.)
- 3. Terminal 4 input selection**
Turn ON the terminal 4 input selection signal (AU). Input to the terminal 4 is enabled.
- 4. Start**
Press  or . [FWD] or [REV] flickers as no frequency command is given.
- 5. Acceleration → constant speed**
Input 20 mA. The frequency value on the indication increases in **Pr.7 Acceleration time**, and "60.00" (60.00 Hz) appears.
- 6. Deceleration**
Input 4 mA or less. The frequency value on the indication decreases in **Pr.8 Deceleration time**, and the motor stops rotating with "00.0" (0.00 Hz) displayed. [FWD] or [REV] indicator flickers.
- 7. Stop**
Press . [FWD] or [REV] indicator turns OFF.

NOTE

- **Pr.184 AU terminal function selection** must be set to "4" (AU signal) (initial value).
- To change the frequency (60 Hz) at the maximum current input (initial value 20 mA), adjust **Pr.126 Terminal 4 frequency setting gain frequency**.
- To change the frequency (0 Hz) at the minimum current input (initial value 4 mA), adjust the **calibration parameter C5 Terminal 4 frequency setting bias frequency**.

● Basic operation procedure (External operation)

POINT

- Where is the frequency command source?
 - The frequency set in the frequency setting mode of the operation panel → Refer to **page 59**.
 - Switches (multi-speed setting) → Refer to **page 60**.
 - Voltage input signals → Refer to **page 61**.
 - Current input signals → Refer **page 63**.

◆ Using the frequency set by the operation panel

POINT

- Switch ON the STF (STR) signal to give a start command.
- Use the operation panel (FR-DU08) () to give a start command.
- Set **Pr.79** = "3" (External/PU combined operation mode 1).

[Connection diagram]

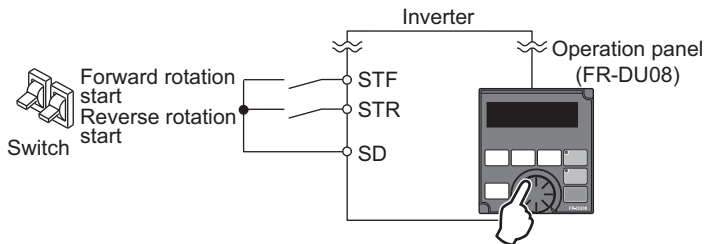

Operation example Operate at 30 Hz.

Operation



1. Changing the operation mode

Set "3" in **Pr.79**. [PU] and [EXT] indicators are on. (For setting value change, refer to **page 50**.)

Setting the frequency

Turn  to until the target frequency, "30.00" (30.00 Hz), appears. The frequency flickers for about 5 s.

While the value is flickering, press  to enter the frequency. "F" and "30.00" flicker alternately. After about 3 s of flickering, the indication goes back to "0.00" (monitor display).

(If  is not pressed, the indication of the value goes back to "0.00" (0.00 Hz) after about 5 s of flickering. In that case, turn  again and set the frequency.)

Start → acceleration → constant speed

Turn ON the start switch (STF or STR). The frequency value on the indication increases in **Pr.7 Acceleration time**, and "30.00" (30.00 Hz) appears. [FWD] indicator is on during the forward rotation, and [REV] indicator is on during the reverse rotation. (To change the set frequency, perform the operation in above step 2. The previously set frequency appears.)

Deceleration → stop

Turn OFF the start switch (STF or STR). The frequency value on the indication decreases in **Pr.8 Deceleration time**, and the motor stops rotating with "0.00" (0.00 Hz) displayed.

NOTE

- When both the forward rotation switch (STF) and the reverse rotation switch (STR) are ON, the motor cannot be started. If both are turned ON while the inverter is running, the inverter decelerates to a stop.
- **Pr.178 STF terminal function selection** must be set to "60" (or **Pr.179 STR terminal function selection** must be set to "61"). (All are initial values.)
- Setting **Pr.79 Operation mode selection**= "3" also enables multi-speed operation.

• If stopped using  on the operation panel (FR-DU08) during the External operation, the inverter enters the PU stop status. ("PS" appears on the operation panel.)

To reset the PU stop status, turn OFF the start switch (STF or STR), and then press .

◆ Setting the frequency by switches (multi-speed setting) (Pr.4 to Pr.6)

POINT

- Switch ON the STF (STR) signal to give a start command.
- Turn ON the RH, RM, or RL signal to give a frequency command. (Multi-speed setting)

[Connection diagram]

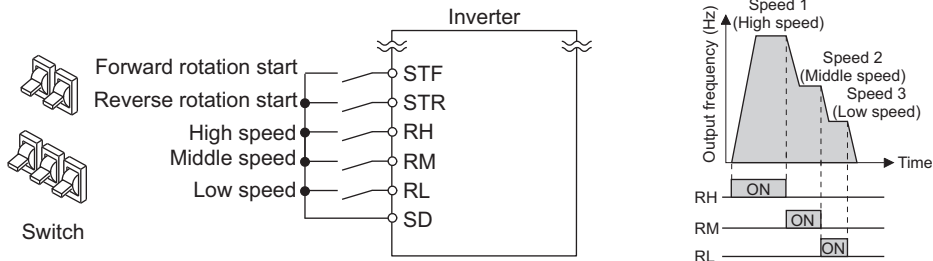

Changing example Operate at a high-speed (60 Hz).

Operation

- 1. Screen at power-ON**
The monitor display appears.
- 2. Setting the frequency**
Turn ON the high-speed switch (RH).
- 3. Start → acceleration → constant speed**
Turn ON the start switch (STF or STR). The frequency value on the indication increases in **Pr.7 Acceleration time**, and "60.00" (60.00 Hz) appears. [FWD] indicator is on during the forward rotation, and [REV] indicator is on during the reverse rotation.
● When RM is turned ON, 30 Hz is displayed. When RL is turned ON, 10 Hz is displayed.
- 4. Deceleration → stop**
Turn OFF the start switch (STF or STR). The frequency value on the indication decreases in **Pr.8 Deceleration time**, and the motor stops rotating with "0.00" (0.00 Hz) displayed. [FWD] or [REV] indicator turns OFF. Turn OFF the high-speed switch (RH).

NOTE

- When both the forward rotation switch (STF) and the reverse rotation switch (STR) are ON, the motor cannot be started. If both are turned ON while the inverter is running, the inverter decelerates to a stop.
- The terminal RH is initially set to 60 Hz for the FM type inverter, and to 50 Hz for the CA type inverter. The terminal RM is set to 30 Hz, and the RL is set to 10 Hz. (To change, set **Pr.4, Pr.5, and Pr.6.**)
- In the initial setting, when two or more of multi-speed settings are simultaneously selected, priority is given to the set frequency of the lower signal.
For example, when RH and RM signals turn ON, RM signal (**Pr.5**) has a higher priority.
- Maximum of 15-speed operation can be performed.

◆ Setting the frequency with analog signals (voltage input)

POINT

- Switch ON the STF (STR) signal to give a start command.
- Use the potentiometer (frequency setting potentiometer) to give a frequency command. (by connecting it across terminals 2 and 5 (voltage input)).

[Connection diagram]

(The inverter supplies 5 V power to the frequency setting potentiometer (terminal 10).)

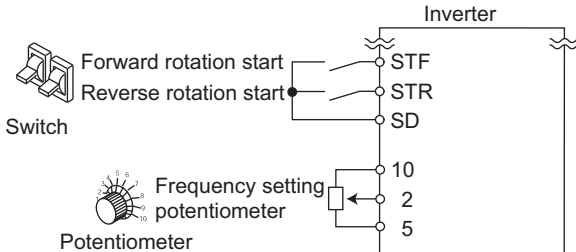

Operation example

Operate at 60 Hz.

Operation

- 1. Screen at power-ON**
The monitor display appears.
- 2. Start**
Turn ON the start switch (STF or STR). [FWD] or [REV] flickers as no frequency command is given.
- 3. Acceleration → constant speed**
Turn the potentiometer (frequency setting potentiometer) clockwise slowly to full. The frequency value on the indication increases in **Pr.7 Acceleration time**, and "60.00" (60.00 Hz) appears. [FWD] indicator is on during the forward rotation, and [REV] indicator is on during the reverse rotation.
- 4. Deceleration**
Turn the potentiometer (frequency setting potentiometer) counterclockwise slowly to full. The frequency value on the indication decreases in **Pr.8 Deceleration time**, and the motor stops rotating with "00.00" (0.00 Hz) displayed.
- 5. Stop**
Turn OFF the start switch (STF or STR). [FWD] or [REV] indicator turns OFF.

NOTE

- When both the forward rotation switch (STF) and the reverse rotation switch (STR) are ON, the motor cannot be started. If both are turned ON while the inverter is running, the inverter decelerates to a stop.
- **Pr.178 STF terminal function selection** must be set to "60" (or **Pr.179 STR terminal function selection** must be set to "61"). (All are initial values.)
- When terminal 10 is used, the maximum output frequency may fluctuate in a range of ± 6 Hz due to fluctuations in the output voltage (5 ± 0.5 VDC). Use **Pr.125** or **Pr.C4** to adjust the output frequency at the maximum analog input as required.
- When terminal 10E is used, the maximum output frequency may fluctuate (in a range of ± 2 to 3 Hz) due to fluctuations in the output voltage (10 ± 0.4 VDC). Use **Pr.125** or **Pr.C4** to adjust the output frequency at the maximum analog input as required.



◆ Changing the frequency (60 Hz, initial value) at the maximum voltage input (5 V, initial value)

Change the maximum frequency.



Changing example With a 0 to 5 VDC input frequency setting potentiometer, change the frequency at 5 V from 60 Hz (initial value) to 50 Hz.
Adjust the setting so that the inverter outputs 50 Hz when 5 V is input.
Set "50 Hz" in **Pr.125**.

Operation

Parameter selection

1. Turn  until "P. 125" (Pr.125) appears.
Press  to show the present set value. (60.00 Hz)

Changing the maximum frequency

2. Turn  to change the set value to "50.00". (50.00 Hz)
Press  to enter the setting. "50.00" and "P. 125" flicker alternately.

Checking the mode/monitor

3. Press  three times to change to the monitor / frequency monitor.

Start

4. Turn ON the start switch (STF or STR), then turn the potentiometer (frequency setting potentiometer) clockwise slowly to full. (Refer to steps 2 and 3 in **page 61**.)
Operate at 50 Hz.

NOTE

- To set the frequency at 0 V, use the **calibration parameter C2**.

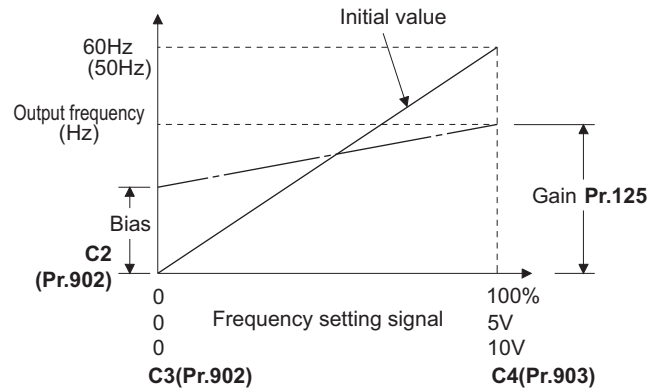

- Other adjustment methods for the frequency setting voltage gain are the following: adjustment by applying a voltage directly across terminals 2 and 5, and adjustment using a specified point without applying a voltage across terminals 2 and 5.

◆ Using an analog signal (current input) to give a frequency command

POINT

- Switch ON the STF (STR) signal to give a start command.
- Turn ON the AU signal.

[Connection diagram]

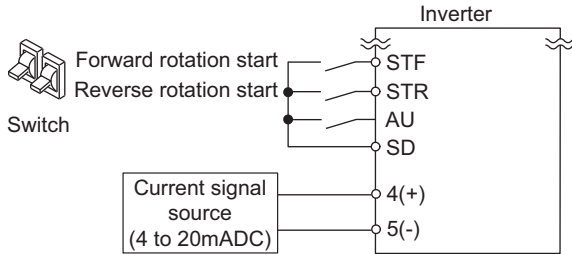

Operation example Operate at 60 Hz.

Operation

1.	Screen at power-ON The monitor display appears.
2.	Terminal 4 input selection Turn ON the terminal 4 input selection signal (AU). Input to the terminal 4 is enabled.
3.	Start Turn ON the start switch (STF or STR). [FWD] or [REV] flickers as no frequency command is given.
4.	Acceleration → constant speed Input 20 mA. The frequency value on the indication increases in Pr.7 Acceleration time , and "60.00" (60.00 Hz) appears. [FWD] indicator is on during the forward rotation, and [REV] indicator is on during the reverse rotation.
5.	Deceleration Input 4 mA or less. The frequency value on the indication decreases in Pr.8 Deceleration time , and the motor stops rotating with "00.00" (0.00 Hz) displayed. [FWD] or [REV] indicator flickers.
6.	Stop Turn OFF the start switch (STF or STR). [FWD] or [REV] indicator turns OFF.

NOTE



- When both the forward rotation switch (STF) and the reverse rotation switch (STR) are ON, the motor cannot be started. If both are turned ON while the inverter is running, the inverter decelerates to a stop.
- **Pr.184 AU terminal function selection** must be set to "4" (AU signal) (initial value).



◆ **Changing the frequency (60 Hz, initial value) at the maximum current input (at 20 mA, initial value)**

Change the maximum frequency.

Changing example With a 4 to 20 mA input frequency setting potentiometer, change the frequency at 20 mA from 60 Hz (initial value) to 50 Hz.
Adjust the setting so that the inverter outputs 50 Hz when 20 mA is input.
Set "50 Hz" in **Pr.126**.

Operation

1. **Parameter selection**
Turn  until "P. 126" (Pr.126) appears.
Press  to show the present set value. (60.00 Hz)

2. **Changing the maximum frequency**
Turn  to change the set value to "50.00". (50.00 Hz)
Press  to enter the setting. "50.00" and "P. 126" flicker alternately.

3. **Checking the mode/monitor**
Press  three times to change to the monitor / frequency monitor.

4. **Start**
Turn ON the start switch (STF or STR), then turn the potentiometer (frequency setting potentiometer) clockwise slowly to full.
(Refer to steps 3 and 4 in **page 63**.)
Operate at 50 Hz.

NOTE

- To set the frequency at 4 mA, use the **calibration parameter C5**.

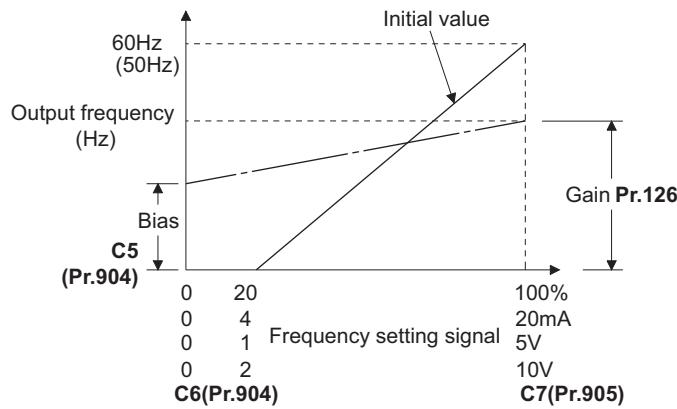

- Other adjustment methods for the frequency setting current gain are the following: adjustment by applying a current through terminals 4 and 5, and adjustment using a specified point without applying a current through terminals 4 and 5.

Parameter List

● Inverter parameter list (by parameter number)

For simple variable-speed operation of the inverter, the initial value of the parameters may be used as they are. Set the necessary parameters to meet the load and operational specifications. Parameter setting, change and check can be made from the operation panel (FR-DU08).



- **Simple** indicates simple mode parameters. Use **Pr.160 User group read selection** to indicate the simple mode parameters only.
- Parameter setting may be restricted in some operating status. Use **Pr.77 Parameter write selection** to change the setting.

Function	Pr.	Pr. group	Name	Setting range	Minimum setting increments	Initial value		Customer setting
						FM	CA	
Basic functions	0	G000	Torque boost Simple	0 to 30%	0.1%	6% *1		
						4% *1		
						3% *1		
						2% *1		
						1.5% *1		
						1% *1		
	1	H400	Maximum frequency Simple	0 to 120 Hz	0.01 Hz	120 Hz *2		
						60 Hz *3		
	2	H401	Minimum frequency Simple	0 to 120 Hz	0.01 Hz	0 Hz		
3	G001	Base frequency Simple	0 to 590 Hz	0.01 Hz	60 Hz	50 Hz		
4	D301	Multi-speed setting (high speed) Simple	0 to 590 Hz	0.01 Hz	60 Hz	50 Hz		
5	D302	Multi-speed setting (middle speed) Simple	0 to 590 Hz	0.01 Hz	30 Hz			
6	D303	Multi-speed setting (low speed) Simple	0 to 590 Hz	0.01 Hz	10 Hz			
7	F010	Acceleration time Simple	0 to 3600 s	0.1 s	5 s *4			
					15 s *5			
8	F011	Deceleration time Simple	0 to 3600 s	0.1 s	10 s *4			
					30 s *5			
9	H000 C103	Electronic thermal O/L relay Simple	0 to 500 A	0.01 A *2	Inverter rated current			
		Rated motor current Simple	0 to 3600 A	0.1 A *3				
DC injection brake	10	G100	DC injection brake operation frequency	0 to 120 Hz, 9999	0.01 Hz	3 Hz		
	11	G101	DC injection brake operation time	0 to 10 s, 8888	0.1 s	0.5 s		
	12	G110	DC injection brake operation voltage	0 to 30%	0.1%	4% *6		
						2% *6		
						1% *6		
—	13	F102	Starting frequency	0 to 60 Hz	0.01 Hz	0.5 Hz		
—	14	G003	Load pattern selection	0, 1, 12 to 15	1	1		
Jog operation	15	D200	Jog frequency	0 to 590 Hz	0.01 Hz	5 Hz		
	16	F002	Jog acceleration/deceleration time	0 to 3600 s	0.1 s	0.5 s		
—	17	T720	MRS input selection	0, 2, 4	1	0		
—	18	H402	High speed maximum frequency	0 to 590 Hz	0.01 Hz	120 Hz *2		
						60 Hz *3		
—	19	G002	Base frequency voltage	0 to 1000 V, 8888, 9999	0.1 V	9999	8888	
Acceleration/ deceleration times	20	F000	Acceleration/deceleration reference frequency	1 to 590 Hz	0.01 Hz	60 Hz	50 Hz	
	21	F001	Acceleration/deceleration time increments	0, 1	1	0		
Stall prevention	22	H500	Stall prevention operation level	0 to 400%	0.1%	120%	110%	
	23	H610	Stall prevention operation level compensation factor at double speed	0 to 200%, 9999	0.1%	9999		
Multi-speed setting	24 to 27	D304 to D307	Multi-speed setting (4 speed to 7 speed)	0 to 590 Hz, 9999	0.01 Hz	9999		
—	28	D300	Multi-speed input compensation selection	0, 1	1	0		
—	29	F100	Acceleration/deceleration pattern selection	0 to 3, 6	1	0		

Function	Pr.	Pr. group	Name	Setting range	Minimum setting increments	Initial value		Customer setting
						FM	CA	
-	30	E300	Regenerative function selection	0 to 2, 10, 11, 20, 21, 100 to 102, 110, 111, 120, 121 *10	1	0		
				2, 10, 11, 102, 110, 111 *11	1	10		
				0, 2, 10, 20, 100, 102, 110, 120 *12	1	0		
Frequency jump	31	H420	Frequency jump 1A	0 to 590 Hz, 9999	0.01 Hz	9999		
	32	H421	Frequency jump 1B	0 to 590 Hz, 9999	0.01 Hz	9999		
	33	H422	Frequency jump 2A	0 to 590 Hz, 9999	0.01 Hz	9999		
	34	H423	Frequency jump 2B	0 to 590 Hz, 9999	0.01 Hz	9999		
	35	H424	Frequency jump 3A	0 to 590 Hz, 9999	0.01 Hz	9999		
	36	H425	Frequency jump 3B	0 to 590 Hz, 9999	0.01 Hz	9999		
-	37	M000	Speed display	0, 1 to 9998	1	0		
Frequency detection	41	M441	Up-to-frequency sensitivity	0 to 100%	0.1%	10%		
	42	M442	Output frequency detection	0 to 590 Hz	0.01 Hz	6 Hz		
	43	M443	Output frequency detection for reverse rotation	0 to 590 Hz, 9999	0.01 Hz	9999		
Second functions	44	F020	Second acceleration/deceleration time	0 to 3600 s	0.1 s	5 s		
	45	F021	Second deceleration time	0 to 3600 s, 9999	0.1 s	9999		
	46	G010	Second torque boost	0 to 30%, 9999	0.1%	9999		
	47	G011	Second V/F (base frequency)	0 to 590 Hz, 9999	0.01 Hz	9999		
	48	H600	Second stall prevention operation level	0 to 400%	0.1%	120%	110%	
	49	H601	Second stall prevention operation frequency	0 to 590 Hz, 9999	0.01 Hz	0 Hz		
	50	M444	Second output frequency detection	0 to 590 Hz	0.01 Hz	30 Hz		
	51	H010 C203	Second electronic thermal O/L relay Rated second motor current	0 to 500 A, 9999 *2 0 to 3600 A, 9999 *3	0.01 A 0.1 A	9999		
Monitor functions	52	M100	Operation panel main monitor selection	0, 5 to 14, 17, 18, 20, 23 to 25, 34, 38, 40 to 45, 50 to 57, 61, 62, 64, 67 to 69, 81 to 96, 98, 100	1	0		
	54	M300	FM/CA terminal function selection	1 to 3, 5 to 14, 17, 18, 21, 24, 34, 50, 52, 53, 61, 62, 67, 69, 70, 85, 87 to 90, 92, 93, 95, 98	1	1		
	55	M040	Frequency monitoring reference	0 to 590 Hz	0.01 Hz	60 Hz	50 Hz	
	56	M041	Current monitoring reference	0 to 500 A *2 0 to 3600 A *3	0.01 A 0.1 A	Inverter rated current		
	57	A702	Restart coasting time	0, 0.1 to 30 s, 9999	0.1 s	9999		
Automatic restart	58	A703	Restart cushion time	0 to 60 s	0.1 s	1 s		
-	59	F101	Remote function selection	0 to 3, 11 to 13	1	0		
-	60	G030	Energy saving control selection	0, 4, 9	1	0		
-	65	H300	Retry selection	0 to 5	1	0		
-	66	H611	Stall prevention operation reduction starting frequency	0 to 590 Hz	0.01 Hz	60 Hz	50 Hz	
Retry	67	H301	Number of retries at fault occurrence	0 to 10, 101 to 110	1	0		
	68	H302	Retry waiting time	0.1 to 600 s	0.1 s	1 s		
	69	H303	Retry count display erase	0	1	0		
-	70	G107	Parameter for manufacturer setting. Do not set.					
-	71	C100	Applied motor	0 to 6, 13 to 16, 20, 23, 24, 40, 43, 44, 50, 53, 54, 70, 73, 74, 210, 213, 214, 8090, 8093, 8094, 9090, 9093, 9094 *10 *11	1	0		
				0 to 6, 13 to 16, 20, 23, 24, 40, 43, 44, 50, 53, 54, 70, 73, 74, 8090, 8093, 8094, 9090, 9093, 9094 *12				
-	72	E600	PWM frequency selection	0 to 15 *2	1	2		
-	73	T000	Analog input selection	0 to 6, 25 *3	1	1		
-	74	T002	Input filter time constant	0 to 7, 10 to 17	1	1		
-	74	T002	Input filter time constant	0 to 8	1	1		

Function	Pr.	Pr. group	Name	Setting range	Minimum setting increments	Initial value		Customer setting	
						FM	CA		
-	75	-	Reset selection/disconnected PU detection/ PU stop selection	0 to 3, 14 to 17, 1000 to 1003, 1014 to 1017 *2	1	14			
			E100	Reset selection					0 to 3, 14 to 17, 100 to 103, 114 to 117, 1000 to 1003, 1014 to 1017, 1100 to 1103, 1114 to 1117 *3
			E101	Disconnected PU detection					0, 1
			E102	PU stop selection					
			E107	Reset limit					0 *2 0, 1 *3
-	76	M510	Fault code output selection	0 to 2	1	0			
-	77	E400	Parameter write selection	0 to 2	1	0			
-	78	D020	Reverse rotation prevention selection	0 to 2	1	0			
-	79	D000	Operation mode selection <i>Simple</i>	0 to 4, 6, 7	1	0			
Motor constants	80	C101	Motor capacity	0.4 to 55 kW, 9999 *2 0 to 3600 kW, 9999 *3	0.01 kW *2 0.1 kW *3	9999			
	81	C102	Number of motor poles	2, 4, 6, 8, 10, 12, 9999	1	9999			
	82	C125	Motor excitation current	0 to 500 A, 9999 *2 0 to 3600 A, 9999 *3	0.01 A *2 0.1 A *3	9999			
	83	C104	Rated motor voltage	0 to 1000 V	0.1 V	200 V *7 400 V *8			
	84	C105	Rated motor frequency	10 to 400 Hz, 9999	0.01 Hz	9999			
	85	G201	Excitation current break point	0 to 400 Hz, 9999	0.01 Hz	9999			
	86	G202	Excitation current low-speed scaling factor	0 to 300%, 9999	0.1%	9999			
	89	G932	Speed control gain (Advanced magnetic flux vector)	0 to 200%, 9999	0.1%	9999			
	90	C120	Motor constant (R1)	0 to 50 Ω, 9999 *2 0 to 400 mΩ, 9999 *3	0.001 Ω *2 0.01 mΩ *3	9999			
	91	C121	Motor constant (R2)	0 to 50 Ω, 9999 *2 0 to 400 mΩ, 9999 *3	0.001 Ω *2 0.01 mΩ *3	9999			
	92	C122	Motor constant (L1)/d-axis inductance (Ld)	0 to 6000mH, 9999 *2 0 to 400mH, 9999 *3	0.1 mH *2 0.01 mH *3	9999			
	93	C123	Motor constant (L2)/q-axis inductance (Lq)	0 to 6000mH, 9999 *2 0 to 400mH, 9999 *3	0.1 mH *2 0.01 mH *3	9999			
	94	C124	Motor constant (X)	0 to 100%, 9999	0.1% *2 0.01% *3	9999			
	95	C111	Online auto tuning selection	0, 1	1	0			
	96	C110	Auto tuning setting/status	0, 1, 11, 101	1	0			
	Adjustable 5 points V/F	100	G040	V/F1 (first frequency)	0 to 590 Hz, 9999	0.01 Hz	9999		
101		G041	V/F1 (first frequency voltage)	0 to 1000 V	0.1 V	0 V			
102		G042	V/F2 (second frequency)	0 to 590 Hz, 9999	0.01 Hz	9999			
103		G043	V/F2 (second frequency voltage)	0 to 1000 V	0.1 V	0 V			
104		G044	V/F3 (third frequency)	0 to 590 Hz, 9999	0.01 Hz	9999			
105		G045	V/F3 (third frequency voltage)	0 to 1000 V	0.1 V	0 V			
106		G046	V/F4 (fourth frequency)	0 to 590 Hz, 9999	0.01 Hz	9999			
107		G047	V/F4 (fourth frequency voltage)	0 to 1000 V	0.1 V	0 V			
108		G048	V/F5 (fifth frequency)	0 to 590 Hz, 9999	0.01 Hz	9999			
109		G049	V/F5 (fifth frequency voltage)	0 to 1000 V	0.1 V	0 V			
-	111	F031	Check valve deceleration time	0 to 3600 s, 9999	0.1 s	9999			
PU connector communication	117	N020	PU communication station number	0 to 31	1	0			
	118	N021	PU communication speed	48, 96, 192, 384, 576, 768, 1152	1	192			
	119	-	PU communication stop bit length / data length	0, 1, 10, 11	1	1			
		N022	PU communication data length	0, 1		0			
		N023	PU communication stop bit length	0, 1		1			
	120	N024	PU communication parity check	0 to 2	1	2			
	121	N025	PU communication retry count	0 to 10, 9999	1	1			
	122	N026	PU communication check time interval	0, 0.1 to 999.8 s, 9999	0.1 s	9999			
	123	N027	PU communication waiting time setting	0 to 150 ms, 9999	1 ms	9999			
124	N028	PU communication CR/LF selection	0 to 2	1	1				

Function	Pr.	Pr. group	Name	Setting range	Minimum setting increments	Initial value		Customer setting
						FM	CA	
–	125	T022	Terminal 2 frequency setting gain frequency <i>Simple</i>	0 to 590 Hz	0.01 Hz	60 Hz	50 Hz	
–	126	T042	Terminal 4 frequency setting gain frequency <i>Simple</i>	0 to 590 Hz	0.01 Hz	60 Hz	50 Hz	
PID operation	127	A612	PID control automatic switchover frequency	0 to 590 Hz, 9999	0.01 Hz	9999		
	128	A610	PID action selection	0, 10, 11, 20, 21, 50, 51, 60, 61, 70, 71, 80, 81, 90, 91, 100, 101, 1000, 1001, 1010, 1011, 2000, 2001, 2010, 2011	1	0		
	129	A613	PID proportional band	0.1 to 1000%, 9999	0.1%	100%		
	130	A614	PID integral time	0.1 to 3600 s, 9999	0.1 s	1 s		
	131	A601	PID upper limit	0 to 100%, 9999	0.1%	9999		
	132	A602	PID lower limit	0 to 100%, 9999	0.1%	9999		
	133	A611	PID action set point	0 to 100%, 9999	0.01%	9999		
Bypass	134	A615	PID differential time	0.01 to 10 s, 9999	0.01 s	9999		
	135	A000	Electronic bypass sequence selection	0, 1	1	0		
	136	A001	MC switchover interlock time	0 to 100 s	0.1 s	1 s		
	137	A002	Start waiting time	0 to 100 s	0.1 s	0.5 s		
	138	A003	Bypass selection at a fault	0, 1	1	0		
Backlash measures	139	A004	Automatic switchover frequency from inverter to bypass operation	0 to 60 Hz, 9999	0.01 Hz	9999		
	140	F200	Backlash acceleration stopping frequency	0 to 590 Hz	0.01 Hz	1 Hz		
	141	F201	Backlash acceleration stopping time	0 to 360 s	0.1 s	0.5 s		
	142	F202	Backlash deceleration stopping frequency	0 to 590 Hz	0.01 Hz	1 Hz		
–	143	F203	Backlash deceleration stopping time	0 to 360 s	0.1 s	0.5 s		
–	144	M002	Speed setting switchover	0, 2, 4, 6, 8, 10, 12, 102, 104, 106, 108, 110, 112	1	4		
PU	145	E103	PU display language selection	0 to 7	1	–		
–	147	F022	Acceleration/deceleration time switching frequency	0 to 590 Hz, 9999	0.01 Hz	9999		
Current detection	148	H620	Stall prevention level at 0 V input	0 to 400%	0.1%	120%	110%	
	149	H621	Stall prevention level at 10 V input	0 to 400%	0.1%	150%	120%	
	150	M460	Output current detection level	0 to 400%	0.1%	120%	110%	
	151	M461	Output current detection signal delay time	0 to 10 s	0.1 s	0 s		
	152	M462	Zero current detection level	0 to 400%	0.1%	5%		
	153	M463	Zero current detection time	0 to 10 s	0.01 s	0.5 s		
–	154	H631	Voltage reduction selection during stall prevention operation	0, 1, 10, 11	1	1		
–	155	T730	RT signal function validity condition selection	0, 10	1	0		
–	156	H501	Stall prevention operation selection	0 to 31, 100, 101	1	0		
–	157	M430	OL signal output timer	0 to 25 s, 9999	0.1 s	0 s		
–	158	M301	AM terminal function selection	1 to 3, 5 to 14, 17, 18, 21, 24, 34, 50, 52 to 54, 61, 62, 67, 69, 70, 86 to 96, 98	1	1		
–	159	A005	Automatic switchover frequency range from bypass to inverter operation	0 to 10 Hz, 9999	0.01 Hz	9999		
–	160	E440	User group read selection <i>Simple</i>	0, 1, 9999	1	9999	0	
–	161	E200	Frequency setting/key lock operation selection	0, 1, 10, 11	1	0		
Automatic restart functions	162	A700	Automatic restart after instantaneous power failure selection	0 to 3, 10 to 13, 1000 to 1003, 1010 to 1013	1	0		
	163	A704	First cushion time for restart	0 to 20 s	0.1 s	0 s		
	164	A705	First cushion voltage for restart	0 to 100%	0.1%	0%		
	165	A710	Stall prevention operation level for restart	0 to 400%	0.1%	120%	110%	
Current detection	166	M433	Output current detection signal retention time	0 to 10 s, 9999	0.1 s	0.1 s		
	167	M464	Output current detection operation selection	0, 1, 10, 11	1	0		
–	168	E000	Parameter for manufacturer setting. Do not set.					
		E080						
–	169	E001						
		E081						

Function	Pr.	Pr. group	Name	Setting range	Minimum setting increments	Initial value		Customer setting
						FM	CA	
Cumulative monitor clear	170	M020	Watt-hour meter clear	0, 10, 9999	1	9999		
	171	M030	Operation hour meter clear	0, 9999	1	9999		
User group	172	E441	User group registered display/batch clear	9999, (0 to 16)	1	0		
	173	E442	User group registration	0 to 1999, 9999	1	9999		
	174	E443	User group clear	0 to 1999, 9999	1	9999		
Input terminal function assignment	178	T700	STF terminal function selection	0 to 8, 10 to 14, 16, 18, 24, 25, 28, 33, 37 to 40, 46 to 48, 50, 51, 57, 58, 60, 62, 64 to 67, 70 to 73, 77 to 81, 84, 94 to 98, 128, 129, 9999	1	60		
	179	T701	STR terminal function selection	0 to 8, 10 to 14, 16, 18, 24, 25, 28, 33, 37 to 40, 46 to 48, 50, 51, 57, 58, 61, 62, 64 to 67, 70 to 73, 77 to 81, 84, 94 to 98, 128, 129, 9999	1	61		
	180	T702	RL terminal function selection	0 to 8, 10 to 14, 16, 18, 24, 25, 28, 33, 37 to 40, 46 to 48, 50, 51, 57, 58, 62, 64 to 67, 70 to 73, 77 to 81, 84, 94 to 98, 128, 129, 9999	1	0		
	181	T703	RM terminal function selection		1	1		
	182	T704	RH terminal function selection		1	2		
	183	T705	RT terminal function selection		1	3		
	184	T706	AU terminal function selection		1	4		
	185	T707	JOG terminal function selection		1	5		
	186	T708	CS terminal function selection		1	9999		
	187	T709	MRS terminal function selection		1	24 *10*12 10 *11		
	188	T710	STOP terminal function selection		1	25		
189	T711	RES terminal function selection	1		62			
Output terminal function assignment	190	M400	RUN terminal function selection		0 to 5, 7, 8, 10 to 19, 25, 26, 35, 39, 40, 45 to 54, 57, 64 to 68, 70 to 80, 82, 85, 90 to 96, 98 to 105, 107, 108, 110 to 116, 125, 126, 135, 139 to 142, 145 to 154, 157, 164 to 168, 170 to 180, 182, 185, 190 to 196, 198 to 208, 211 to 213, 215, 217 to 220, 226, 228 to 230, 247, 300 to 308, 311 to 313, 315, 317 to 320, 326, 328 to 330, 347, 9999 *16	1	0	
	191	M401	SU terminal function selection	0 to 5, 7, 8, 10 to 19, 25, 26, 35, 39 to 42, 45 to 54, 57, 64 to 68, 70 to 80, 82, 85, 90, 91, 94 to 96, 98 to 105, 107, 108, 110 to 116, 125, 126, 135, 139 to 142, 145 to 154, 157, 164 to 168, 170 to 180, 182, 185, 190, 191, 194 to 196, 198 to 208, 211 to 213, 215, 217 to 220, 226, 228 to 230, 247, 300 to 308, 311 to 313, 315, 317 to 320, 326, 328 to 330, 347, 9999 *16	1	1		
	192	M402	IPF terminal function selection		1	2 *10*12 9999 *11		
	193	M403	OL terminal function selection		1	3		
	194	M404	FU terminal function selection		1	4		
	195	M405	ABC1 terminal function selection		1	99		
	196	M406	ABC2 terminal function selection		1	9999		
Multi-speed setting	232 to 239	D308 to D315	Multi-speed setting (8 speed to 15 speed)		0 to 590 Hz, 9999	0.01 Hz	9999	
	—	240	E601	Soft-PWM operation selection	0, 1	1		
	—	241	M043	Analog input display unit switchover	0, 1	0		
	—	242	T021	Terminal 1 added compensation amount (terminal 2)	0 to 100%	0.1%		100%
	—	243	T041	Terminal 1 added compensation amount (terminal 4)	0 to 100%	0.1%		75%

Function	Pr.	Pr. group	Name	Setting range	Minimum setting increments	Initial value		Customer setting
						FM	CA	
-	244	-	Cooling fan operation selection	0, 1, 101 to 105, 1000, 1001, 1101 to 1105	1	1		
		H100	Cooling fan operation selection	0, 1, 101 to 105	1	1		
		H106	Cooling fan operation selection during the test operation	0, 1	1	0		
Slip compensation	245	G203	Rated slip	0 to 50%, 9999	0.01%	9999		
	246	G204	Slip compensation time constant	0.01 to 10 s	0.01 s	0.5 s		
	247	G205	Constant-power range slip compensation selection	0, 9999	1	9999		
-	248	A006	Self power management selection	0 to 2	1	0		
-	249	H101	Earth (ground) fault detection at start	0, 1	1	0		
-	250	G106	Stop selection	0 to 100 s, 1000 to 1100 s, 8888, 9999	0.1 s	9999		
-	251	H200	Output phase loss protection selection	0, 1	1	1		
Frequency compensation function	252	T050	Override bias	0 to 200%	0.1%	50%		
	253	T051	Override gain	0 to 200%	0.1%	150%		
-	254	A007	Main circuit power OFF waiting time	1 to 3600 s, 9999	1 s	600 s		
Life check	255	E700	Life alarm status display	(0 to 255)	1	0		
	256 *14	E701	Inrush current limit circuit life display	(0 to 100%)	1%	100%		
	257	E702	Control circuit capacitor life display	(0 to 100%)	1%	100%		
	258 *14	E703	Main circuit capacitor life display	(0 to 100%)	1%	100%		
	259 *14	E704	Main circuit capacitor life measuring	0, 1, 11	1	0		
-	260	E602	PWM frequency automatic switchover	0, 1	1	1		
Power failure stop	261	A730	Power failure stop selection	0 to 2, 11, 12, 21, 22	1	0		
	262	A731	Subtracted frequency at deceleration start	0 to 20 Hz	0.01 Hz	3 Hz		
	263	A732	Subtraction starting frequency	0 to 590 Hz, 9999	0.01 Hz	60 Hz	50 Hz	
	264	A733	Power-failure deceleration time 1	0 to 3600 s	0.1 s	5 s		
	265	A734	Power-failure deceleration time 2	0 to 3600 s, 9999	0.1 s	9999		
	266	A735	Power failure deceleration time switchover frequency	0 to 590 Hz	0.01 Hz	60 Hz	50 Hz	
-	267	T001	Terminal 4 input selection	0 to 2	1	0		
-	268	M022	Monitor decimal digits selection	0, 1, 9999	1	9999		
-	269	E023	Parameter for manufacturer setting. Do not set.					
-	289	M431	Inverter output terminal filter	5 to 50 ms, 9999	1 ms	9999		
-	290	M044	Monitor negative output selection	0 to 7	1	0		
-	291	D100	Pulse train I/O selection	[FM Type] 0, 1, 10, 11, 20, 21, 100 [CA Type] 0, 1	1	0		
-	294	A785	UV avoidance voltage gain	0 to 200%	0.1%	100%		
-	295	E201	Frequency change increment amount setting	0, 0.01, 0.1, 1, 10	0.01	0		
Password function	296	E410	Password lock level	0 to 6, 99, 100 to 106, 199, 9999	1	9999		
	297	E411	Password lock/unlock	(0 to 5), 1000 to 9998, 9999	1	9999		
-	298	A711	Frequency search gain	0 to 32767, 9999	1	9999		
-	299	A701	Rotation direction detection selection at restarting	0, 1, 9999	1	9999		

Function	Pr.	Pr. group	Name	Setting range	Minimum setting increments	Initial value		Customer setting
						FM	CA	
PLC	313 *15	M410	DO0 output selection	0 to 5, 7, 8, 10 to 19, 25, 26, 35, 39 to 42, 45 to 54, 57, 64 to 66, 68, 70 to 80, 85 to 96, 98 to 105, 107, 108, 110 to 116, 125, 126, 135, 139 to 142, 145 to 154, 157, 164 to 166, 168, 170 to 180, 185 to 196, 198 to 208, 211 to 213, 215, 217 to 220, 226, 228 to 230, 247 to 250, 300 to 308, 311 to 313, 315, 317 to 320, 326, 328 to 330, 347 to 350, 9999	1	9999		
	314 *15	M411	DO1 output selection		1	9999		
	315 *15	M412	DO2 output selection		1	9999		
	316 *15	M413	DO3 output selection		1	9999		
	317 *15	M414	DO4 output selection		1	9999		
	318 *15	M415	DO5 output selection		1	9999		
	319 *15	M416	DO6 output selection		1	9999		
	320 *15	M420	RA1 output selection	0 to 5, 7, 8, 10 to 19, 25, 26, 35, 39 to 42, 45 to 54, 57, 64 to 66, 68, 70 to 80, 85 to 91, 94 to 96, 98, 99, 200 to 208, 211 to 213, 215, 217 to 220, 226, 228 to 230, 247 to 250, 9999	1	0		
	321 *15	M421	RA2 output selection		1	1		
	322 *15	M422	RA3 output selection		1	2 *10*12		
RS-485 communication	331 *17	N030	RS-485 communication station number	0 to 31 (0 to 247)	1	0		
	332 *17	N031	RS-485 communication speed	3, 6, 12, 24, 48, 96, 192, 384, 576, 768, 1152	1	96		
	333 *17	-	RS-485 communication stop bit length / data length	0, 1, 10, 11	1	1		
		N032	PU communication data length	0, 1	1	0		
		N033	PU communication stop bit length	0, 1	1	1		
	334 *17	N034	RS-485 communication parity check selection	0 to 2	1	2		
	335 *17	N035	RS-485 communication retry count	0 to 10, 9999	1	1		
	336 *17	N036	RS-485 communication check time interval	0 to 999.8 s, 9999	0.1 s	0 s		
	337 *17	N037	RS-485 communication waiting time setting	0 to 150 ms, 9999	1 ms	9999		
	338	D010	Communication operation command source	0, 1	1	0		
	339	D011	Communication speed command source	0 to 2	1	0		
	340	D001	Communication startup mode selection	0 to 2, 10, 12	1	0		
	341 *17	N038	RS-485 communication CR/LF selection	0 to 2	1	1		
	342	N001	Communication EEPROM write selection	0, 1	1	0		
343 *17	N080	Communication error count	-	1	0			
-	374	H800	Overspeed detection level	0 to 590 Hz, 9999	0.01 Hz	9999		
Pulse train input	384	D101	Input pulse division scaling factor	0 to 250	1	0		
	385	D110	Frequency for zero input pulse	0 to 590 Hz	0.01 Hz	0 Hz		
	386	D111	Frequency for maximum input pulse	0 to 590 Hz	0.01 Hz	60 Hz	50 Hz	
-	390	N054	% setting reference frequency	1 to 590 Hz	0.01 Hz	60 Hz	50 Hz	
PLC function	414	A800	PLC function operation selection	0 to 2, 11, 12	1	0		
	415	A801	Inverter operation lock mode setting	0, 1	1	0		
	416	A802	Pre-scale function selection	0 to 5	1	0		
	417	A803	Pre-scale setting value	0 to 32767	1	1		

Function	Pr.	Pr. group	Name	Setting range	Minimum setting increments	Initial value		Customer setting
						FM	CA	
Second motor constants	450	C200	Second applied motor	0, 1, 3 to 6, 13 to 16, 20, 23, 24, 40, 43, 44, 50, 53, 54, 70, 73, 74, 210, 213, 214, 240, 243, 244, 8090, 8093, 8094, 9090, 9093, 9094, 9999	1	9999		
	453	C201	Second motor capacity	0.4 to 55 kW, 9999 *2 0 to 3600 kW, 9999 *3	0.01 kW *2 0.1 kW *3	9999		
	454	C202	Number of second motor poles	2, 4, 6, 8, 10, 12, 9999	1	9999		
	455	C225	Second motor excitation current	0 to 500 A, 9999 *2 0 to 3600 A, 9999 *3	0.01 A *2 0.1 A *3	9999		
	456	C204	Rated second motor voltage	0 to 1000 V	0.1 V	200 V 400 V		
	457	C205	Rated second motor frequency	10 to 400 Hz, 9999	0.01 Hz	9999		
	458	C220	Second motor constant (R1)	0 to 50 Ω, 9999 *2 0 to 400 mΩ, 9999 *3	0.001 Ω *2 0.01 mΩ *3	9999		
	459	C221	Second motor constant (R2)	0 to 50 Ω, 9999 *2 0 to 400 mΩ, 9999 *3	0.001 Ω*2 0.01 mΩ *3	9999		
	460	C222	Second motor constant (L1) / d-axis inductance (Ld)	0 to 6000mH, 9999 *2 0 to 400mH, 9999 *3	0.1 mH *2 0.01 mH *3	9999		
	461	C223	Second motor constant (L2) / q-axis inductance (Lq)	0 to 6000mH, 9999 *2 0 to 400mH, 9999 *3	0.1 mH *2 0.01 mH *3	9999		
	462	C224	Second motor constant (X)	0 to 100%, 9999	0.1% *2 0.01% *3	9999		
	463	C210	Second motor auto tuning setting/status	0, 1, 11, 101	1	0		
Remote output	495	M500	Remote output selection	0, 1, 10, 11	1	0		
	496	M501	Remote output data 1	0 to 4095	1	0		
	497	M502	Remote output data 2	0 to 4095	1	0		
-	498	A804	PLC function flash memory clear	0 to 9999	1	0		
-	502	N013	Stop mode selection at communication error	0 to 4	1	0		
Maintenance	503	E710	Maintenance timer 1	0 (1 to 9998)	1	0		
	504	E711	Maintenance timer 1 warning output set time	0 to 9998, 9999	1	9999		
-	505	M001	Speed setting reference	1 to 590 Hz	0.01 Hz	60 Hz	50 Hz	
-	506 *14	E705	Display estimated main circuit capacitor residual life	(0% to 100%)	1%	100%		
-	507	E706	Display/reset ABC1 relay contact life	0% to 100%	1%	100%		
-	508	E707	Display/reset ABC2 relay contact life	0% to 100%	1%	100%		
-	514 *14	H324	Emergency drive dedicated retry waiting time	0.1 to 600 s, 9999	0.1 s	9999		
-	515 *14	H322	Emergency drive dedicated retry count	1 to 200, 9999	1	1		
-	522	G105	Output stop frequency	0 to 590 Hz, 9999	0.01 Hz	9999		
-	523 *14	H320	Emergency drive mode selection	100, 111, 112, 121 to 124, 200, 211, 212, 221 to 224, 300, 311, 312, 321 to 324, 400, 411, 412, 421 to 424, 9999	1	9999		
-	524 *14	H321	Emergency drive running speed	0 to 590 Hz, 9999	0.01 Hz	9999		
-	539 *17	N002	MODBUS RTU communication check time interval	0 to 999.8 s, 9999	0.1 s	9999		
USB	547	N040	USB communication station number	0 to 31	1	0		
	548	N041	USB communication check time interval	0 to 999.8 s, 9999	0.1 s	9999		
Communication	549 *17	N000	Protocol selection	0, 1, 2	1	0		
	550	D012	NET mode operation command source selection	0, 1, 9999 *16	1	9999		
	551	D013	PU mode operation command source selection	1 to 3, 9999 *16	1	9999		
-	552	H429	Frequency jump range	0 to 30 Hz, 9999	0.01 Hz	9999		
PID control	553	A603	PID deviation limit	0 to 100%, 9999	0.1%	9999		
	554	A604	PID signal operation selection	0 to 7, 10 to 17	1	0		

Function	Pr.	Pr. group	Name	Setting range	Minimum setting increments	Initial value		Customer setting
						FM	CA	
Current average value monitor	555	E720	Current average time	0.1 to 1 s	0.1 s	1 s		
	556	E721	Data output mask time	0 to 20 s	0.1 s	0 s		
	557	E722	Current average value monitor signal output reference current	0 to 500 A*2 0 to 3600 A*3	0.01 A *2 0.1 A *3	Inverter rated current		
—	560	A712	Second frequency search gain	0 to 32767, 9999	1	9999		
—	561	H020	PTC thermistor protection level	0.5 to 30 kΩ, 9999	0.01 kΩ	9999		
—	563	M021	Energization time carrying-over times	(0 to 65535)	1	0		
—	564	M031	Operating time carrying-over times	(0 to 65535)	1	0		
—	565	G301	Second motor excitation current break point	0 to 400 Hz, 9999	0.01 Hz	9999		
—	566	G302	Second motor excitation current low-speed scaling factor	0 to 300%, 9999	0.1%	9999		
Second motor constants	569	G942	Second motor speed control gain	0 to 200%, 9999	0.1%	9999		
Multiple rating	570	E301	Multiple rating setting	0, 1	1	1	0	
—	571	F103	Holding time at a start	0 to 10 s, 9999	0.1 s	9999		
—	573	A680 T052	4 mA input check selection	1 to 4, 11 to 14, 21 to 24, 9999	1	9999		
—	574	C211	Second motor online auto tuning	0, 1	1	0		
PID control	575	A621	Output interruption detection time	0 to 3600 s, 9999	0.1 s	1 s		
	576	A622	Output interruption detection level	0 to 590 Hz	0.01 Hz	0 Hz		
	577	A623	Output interruption cancel level	900 to 1100%	0.1%	1000%		
Multi-pump function	578	A400	Auxiliary motor operation selection	0 to 3	1	0		
	579	A401	Motor connection function selection	0 to 3	1	0		
	580	A402	MC switchover interlock time (multi-pump)	0 to 100 s	0.1 s	1 s		
	581	A403	Start waiting time (multi-pump)	0 to 100 s	0.1 s	1 s		
	582	A404	Auxiliary motor connection-time deceleration time	0 to 3600 s, 9999	0.1 s	1 s		
	583	A405	Auxiliary motor disconnection-time acceleration time	0 to 3600 s, 9999	0.1 s	1 s		
	584	A406	Auxiliary motor 1 starting frequency	0 to 590 Hz	0.01 Hz	60 Hz	50 Hz	
	585	A407	Auxiliary motor 2 starting frequency	0 to 590 Hz	0.01 Hz	60 Hz	50 Hz	
	586	A408	Auxiliary motor 3 starting frequency	0 to 590 Hz	0.01 Hz	60 Hz	50 Hz	
	587	A409	Auxiliary motor 1 stopping frequency	0 to 590 Hz	0.01 Hz	0 Hz		
	588	A410	Auxiliary motor 2 stopping frequency	0 to 590 Hz	0.01 Hz	0 Hz		
	589	A411	Auxiliary motor 3 stopping frequency	0 to 590 Hz	0.01 Hz	0 Hz		
	590	A412	Auxiliary motor start detection time	0 to 3600 s	0.1 s	5 s		
	591	A413	Auxiliary motor stop detection time	0 to 3600 s	0.1 s	5 s		
Traverse function	592	A300	Traverse function selection	0 to 2	1	0		
	593	A301	Maximum amplitude amount	0 to 25%	0.1%	10%		
	594	A302	Amplitude compensation amount during deceleration	0 to 50%	0.1%	10%		
	595	A303	Amplitude compensation amount during acceleration	0 to 50%	0.1%	10%		
	596	A304	Amplitude acceleration time	0.1 to 3600 s	0.1 s	5 s		
	597	A305	Amplitude deceleration time	0.1 to 3600 s	0.1 s	5 s		
—	598	H102	Undervoltage level	175 to 215 VDC, 9999 *7 350 to 430 VDC, 9999 *8	0.1 V	9999		
—	599	T721	X10 terminal input selection	0, 1	1	0 *10*12	1 *11	
Electronic thermal O/L relay	600	H001	First free thermal reduction frequency 1	0 to 590 Hz, 9999	0.01 Hz	9999		
	601	H002	First free thermal reduction ratio 1	1 to 100%	1%	100%		
	602	H003	First free thermal reduction frequency 2	0 to 590 Hz, 9999	0.01 Hz	9999		
	603	H004	First free thermal reduction ratio 2	1 to 100%	1%	100%		
	604	H005	First free thermal reduction frequency 3	0 to 590 Hz, 9999	0.01 Hz	9999		
—	606	T722	Power failure stop external signal input selection	0, 1	1	1		

Function	Pr.	Pr. group	Name	Setting range	Minimum setting increments	Initial value		Customer setting
						FM	CA	
—	607	H006	Motor permissible load level	110 to 250%	1%	150%		
—	608	H016	Second motor permissible load level	110 to 250%, 9999	1%	9999		
PID control	609	A624	PID set point/deviation input selection	1 to 5	1	2		
	610	A625	PID measured value input selection	1 to 5, 101 to 105	1	3		
—	611	F003	Acceleration time at a restart	0 to 3600 s, 9999	0.1 s	9999		
—	617	G080	Reverse rotation excitation current low-speed scaling factor	0 to 300%, 9999	0.1%	9999		
Speed smoothing control	653	G410	Speed smoothing control	0 to 200%	0.1%	0%		
	654	G411	Speed smoothing cutoff frequency	0 to 120 Hz	0.01 Hz	20 Hz		
Analog remote output function	655	M530	Analog remote output selection	0, 1, 10, 11	1	0		
	656	M531	Analog remote output 1	800 to 1200%	0.1%	1000%		
	657	M532	Analog remote output 2	800 to 1200%	0.1%	1000%		
	658	M533	Analog remote output 3	800 to 1200%	0.1%	1000%		
	659	M534	Analog remote output 4	800 to 1200%	0.1%	1000%		
Increased magnetic excitation deceleration	660	G130	Increased magnetic excitation deceleration operation selection	0, 1	1	0		
	661	G131	Magnetic excitation increase rate	0 to 40%, 9999	0.1%	9999		
	662	G132	Increased magnetic excitation current level	0 to 300%	0.1%	100%		
—	663	M060	Control circuit temperature signal output level	0 to 100°C	1°C	0°C		
—	665	G125	Regeneration avoidance frequency gain	0 to 200%	0.1%	100%		
—	668	A786	Power failure stop frequency gain	0 to 200%	0.1%	100%		
—	673	G060	SF-PR slip amount adjustment operation selection	2, 4, 6, 9999	1	9999		
—	674	G061	SF-PR slip amount adjustment gain	0 to 500%	0.1%	100%		
—	675	A805	User parameter auto storage function selection	1, 9999	1	9999		
—	684	C000	Tuning data unit switchover	0, 1	1	0		
Maintenance	686	E712	Maintenance timer 2	0 (1 to 9998)	1	0		
	687	E713	Maintenance timer 2 warning output set time	0 to 9998, 9999	1	9999		
	688	E714	Maintenance timer 3	0 (1 to 9998)	1	0		
	689	E715	Maintenance timer 3 warning output set time	0 to 9998, 9999	1	9999		
	Electronic thermal O/L relay	692	H011	Second free thermal reduction frequency 1	0 to 590 Hz, 9999	0.01 Hz	9999	
693		H012	Second free thermal reduction ratio 1	1 to 100%	1%	100%		
694		H013	Second free thermal reduction frequency 2	0 to 590 Hz, 9999	0.01 Hz	9999		
695		H014	Second free thermal reduction ratio 2	1 to 100%	1%	100%		
696		H015	Second free thermal reduction frequency 3	0 to 590 Hz, 9999	0.01 Hz	9999		
—		699	T740	Input terminal filter	5 to 50 ms, 9999	1 ms	9999	
Motor constants	702	C106	Maximum motor frequency	0 to 400 Hz, 9999	0.01 Hz	9999		
	706	C130	Induced voltage constant (ϕ f)	0 to 5000 mV/(rad/s), 9999	0.1 mV/(rad/s)	9999		
	707	C107	Motor inertia (integer)	10 to 999, 9999	1	9999		
	711	C131	Motor Ld decay ratio	0 to 100%, 9999	0.1%	9999		
	712	C132	Motor Lq decay ratio	0 to 100%, 9999	0.1%	9999		
	717	C182	Starting resistance tuning compensation	0 to 200%, 9999	0.1%	9999		
	721	C185	Starting magnetic pole position detection pulse width	0 to 6000 μ s, 10000 to 16000 μ s, 9999	1 μ s	9999		
	724	C108	Motor inertia (exponent)	0 to 7, 9999	1	9999		
	725	C133	Motor protection current level	100 to 500%, 9999	0.1%	9999		
BACnet MS/TP protocol	726 *17	N050	Auto Baudrate/Max Master	0 to 255	1	255		
	727 *17	N051	Max Info Frames	1 to 255	1	1		
	728	N052	Device instance number (Upper 3 digits)	0 to 419 (0 to 418)	1	0		
	729	N053	Device instance number (Lower 4 digits)	0 to 9999 (0 to 4302)	1	0		

Function	Pr.	Pr. group	Name	Setting range	Minimum setting increments	Initial value		Customer setting	
						FM	CA		
Motor constants	738	C230	Second motor induced voltage constant (phi f)	0 to 5000 mV/(rad/s), 9999	0.1 mV/(rad/s)		9999		
	739	C231	Second motor Ld decay ratio	0 to 100%, 9999	0.1%		9999		
	740	C232	Second motor Lq decay ratio	0 to 100%, 9999	0.1%		9999		
	741	C282	Second starting resistance tuning compensation	0 to 200%, 9999	0.1%		9999		
	742	C285	Second motor magnetic pole detection pulse width	0 to 6000 μs, 10000 to 16000 μs, 9999	1 μs		9999		
	743	C206	Second motor maximum frequency	0 to 400 Hz, 9999	0.01 Hz		9999		
	744	C207	Second motor inertia (integer)	10 to 999, 9999	1		9999		
	745	C208	Second motor inertia (exponent)	0 to 7, 9999	1		9999		
PID control	746	C233	Second motor protection current level	100 to 500%, 9999	0.1%		9999		
	753	A650	Second PID action selection	0, 10, 11, 20, 21, 50, 51, 60, 61, 70, 71, 80, 81, 90, 91, 100, 101, 1000, 1001, 1010, 1011, 2000, 2001, 2010, 2011	1		0		
	754	A652	Second PID control automatic switchover frequency	0 to 590 Hz, 9999	0.01 Hz		9999		
	755	A651	Second PID action set point	0 to 100%, 9999	0.01%		9999		
	756	A653	Second PID proportional band	0.1 to 1000%, 9999	0.1%		100%		
	757	A654	Second PID integral time	0.1 to 3600 s, 9999	0.1 s		1 s		
	758	A655	Second PID differential time	0.01 to 10 s, 9999	0.01 s		9999		
PID pre-charge function	759	A600	PID unit selection	0 to 43, 9999	1		9999		
	760	A616	Pre-charge fault selection	0, 1	1		0		
	761	A617	Pre-charge ending level	0 to 100%, 9999	0.1%		9999		
	762	A618	Pre-charge ending time	0 to 3600 s, 9999	0.1 s		9999		
	763	A619	Pre-charge upper detection level	0 to 100%, 9999	0.1%		9999		
	764	A620	Pre-charge time limit	0 to 3600 s, 9999	0.1 s		9999		
	765	A656	Second pre-charge fault selection	0, 1	1		0		
	766	A657	Second pre-charge ending level	0 to 100%, 9999	0.1%		9999		
	767	A658	Second pre-charge ending time	0 to 3600 s, 9999	0.1 s		9999		
	768	A659	Second pre-charge upper detection level	0 to 100%, 9999	0.1%		9999		
	769	A660	Second pre-charge time limit	0 to 3600 s, 9999	0.1 s		9999		
Monitor function	774	M101	Operation panel monitor selection 1	1 to 3, 5 to 14, 17, 18, 20, 23 to 25, 34, 38, 40 to 45, 50 to 57, 61, 62, 64, 67 to 69, 81 to 96, 98, 100, 9999	1		9999		
	775	M102	Operation panel monitor selection 2		1		9999		
	776	M103	Operation panel monitor selection 3		1		9999		
—	777	A681 T053	4 mA input check operation frequency	0 to 590 Hz, 9999	0.01 Hz		9999		
—	778	A682 T054	4 mA input check filter	0 to 10 s	0.01 s		0 s		
—	779	N014	Operation frequency during communication error	0 to 590 Hz, 9999	0.01 Hz		9999		
—	791	F070	Acceleration time in low-speed range	0 to 3600 s, 9999	0.1 s		9999		
—	792	F071	Deceleration time in low-speed range	0 to 3600 s, 9999	0.1 s		9999		
—	799	M520	Pulse increment setting for output power	0.1, 1, 10, 100, 1000 kWh	0.1 kWh		1 kWh		
—	800	G200	Control method selection	9, 20, 109, 110	1		20		
Adjustment function	820	G211	Speed control P gain 1	0 to 1000%	1%		25%		
	821	G212	Speed control integral time 1	0 to 20 s	0.001 s		0.333 s		
	822	T003	Speed setting filter 1	0 to 5 s, 9999	0.001 s		9999		
	824	G213	Torque control P gain 1 (current loop proportional gain)	0 to 500%	1%		50%		
	825	G214	Torque control integral time 1 (current loop integral time)	0 to 500 ms	0.1 ms		40 ms		
	827	G216	Torque detection filter 1	0 to 0.1 s	0.001 s		0 s		
	828	G224	Parameter for manufacturer setting. Do not set.						
	830	G311	Speed control P gain 2	0 to 1000%, 9999	1%		9999		
	831	G312	Speed control integral time 2	0 to 20 s, 9999	0.001 s		9999		
	832	T005	Speed setting filter 2	0 to 5 s, 9999	0.001 s		9999		
	834	G313	Torque control P gain 2	0 to 500%, 9999	1%		9999		
	835	G314	Torque control integral time 2	0 to 500 ms, 9999	0.1 ms		9999		
	837	G316	Torque detection filter 2	0 to 0.1 s, 9999	0.001 s		9999		

Function	Pr.	Pr. group	Name	Setting range	Minimum setting increments	Initial value		Customer setting
						FM	CA	
Additional function	849	T007	Analog input offset adjustment	0 to 200%	0.1%	100%		
	858	T040	Terminal 4 function assignment	0, 4, 9999	1	0		
	859	C126	Torque current/Rated PM motor current	0 to 500 A, 9999 *2 0 to 3600 A, 9999 *3	0.01 A *2 0.1 A *3	9999		
	860	C226	Second motor torque current/Rated PM motor current	0 to 500 A, 9999 *2 0 to 3600 A, 9999 *3	0.01 A *2 0.1 A *3	9999		
	864	M470	Torque detection	0 to 400%	0.1%	150%		
Indication function	866	M042	Torque monitoring reference	0 to 400%	0.1%	150%		
–	867	M321	AM output filter	0 to 5 s	0.01 s	0.01 s		
–	868	T010	Terminal 1 function assignment	0, 4, 9999	1	0		
–	869	M334	Current output filter	0 to 5 s	0.01 s	–	0.02 s	
–	870	M440	Speed detection hysteresis	0 to 5 Hz	0.01 Hz	0 Hz		
Protective Functions	872 *14	H201	Input phase loss protection selection	0, 1	1	0		
	874	H730	OLT level setting	0 to 400%	0.1%	120%	110%	
Regeneration avoidance function	882	G120	Regeneration avoidance operation selection	0 to 2	1	0		
	883	G121	Regeneration avoidance operation level	300 to 1200 V	0.1V	380 VDC *7 760 VDC *8		
	884	G122	Regeneration avoidance at deceleration detection sensitivity	0 to 5	1	0		
	885	G123	Regeneration avoidance compensation frequency limit value	0 to 590 Hz, 9999	0.01 Hz	6 Hz		
	886	G124	Regeneration avoidance voltage gain	0 to 200%	0.1%	100%		
Free parameters	888	E420	Free parameter 1	0 to 9999	1	9999		
	889	E421	Free parameter 2	0 to 9999	1	9999		
–	890	H325	Internal storage device status indication	(0 to 9999)	1	0		
Energy saving monitor	891	M023	Cumulative power monitor digit shifted times	0 to 4, 9999	1	9999		
	892	M200	Load factor	30 to 150%	0.1%	100%		
	893	M201	Energy saving monitor reference (motor capacity)	0.1 to 55 kW *2	0.01 kW *2	Inverter rated capacity		
				0 to 3600 kW *3	0.1 kW *3			
	894	M202	Control selection during commercial power-supply operation	0 to 3	1	0		
	895	M203	Power saving rate reference value	0, 1, 9999	1	9999		
	896	M204	Power unit cost	0 to 500, 9999	0.01	9999		
	897	M205	Power saving monitor average time	0 to 1000 h, 9999	1 h	9999		
	898	M206	Power saving cumulative monitor clear	0, 1, 10, 9999	1	9999		
899	M207	Operation time rate (estimated value)	0 to 100%, 9999	0.1%	9999			

Function	Pr.	Pr. group	Name	Setting range	Minimum setting increments	Initial value		Customer setting
						FM	CA	
Calibration parameters	C0 (900) *0	M310	FM/CA terminal calibration	—	—	—		
	C1 (901) *0	M320	AM terminal calibration	—	—	—		
	C2 (902) *0	T200	Terminal 2 frequency setting bias frequency	0 to 590 Hz	0.01 Hz	0 Hz		
	C3 (902) *0	T201	Terminal 2 frequency setting bias	0 to 300%	0.1%	0%		
	125 (903) *0	T202	Terminal 2 frequency setting gain frequency	0 to 590 Hz	0.01 Hz	60 Hz	50 Hz	
	C4 (903) *0	T203	Terminal 2 frequency setting gain	0 to 300%	0.1%	100%		
	C5 (904) *0	T400	Terminal 4 frequency setting bias frequency	0 to 590 Hz	0.01 Hz	0 Hz		
	C6 (904) *0	T401	Terminal 4 frequency setting bias	0 to 300%	0.1%	20%		
	126 (905) *0	T402	Terminal 4 frequency setting gain frequency	0 to 590 Hz	0.01 Hz	60 Hz	50 Hz	
	C7 (905) *0	T403	Terminal 4 frequency setting gain	0 to 300%	0.1%	100%		
	C12 (917) *0	T100	Terminal 1 bias frequency (speed)	0 to 590 Hz	0.01 Hz	0 Hz		
	C13 (917) *0	T101	Terminal 1 bias (speed)	0 to 300%	0.1%	0%		
	C14 (918) *0	T102	Terminal 1 gain frequency (speed)	0 to 590 Hz	0.01 Hz	60 Hz	50 Hz	
	C15 (918) *0	T103	Terminal 1 gain (speed)	0 to 300%	0.1%	100%		

Function	Pr.	Pr. group	Name	Setting range	Minimum setting increments	Initial value		Customer setting
						FM	CA	
Calibration parameters	C16 (919) *9	T110	Terminal 1 bias command (torque/magnetic flux)	0 to 400%	0.1%	0%		
	C17 (919) *9	T111	Terminal 1 bias (torque/magnetic flux)	0 to 300%	0.1%	0%		
	C18 (920) *9	T112	Terminal 1 gain command (torque/magnetic flux)	0 to 400%	0.1%	150%		
	C19 (920) *9	T113	Terminal 1 gain (torque/magnetic flux)	0 to 300%	0.1%	100%		
	C8 (930) *9	M330	Current output bias signal	0 to 100%	0.1%	—		
	C9 (930) *9	M331	Current output bias current	0 to 100%	0.1%	—	0%	
	C10 (931) *9	M332	Current output gain signal	0 to 100%	0.1%	—	100%	
	C11 (931) *9	M333	Current output gain current	0 to 100%	0.1%	—	100%	
	C38 (932) *9	T410	Terminal 4 bias command (torque/magnetic flux)	0 to 400%	0.1%	0%		
	C39 (932) *9	T411	Terminal 4 bias (torque/magnetic flux)	0 to 300%	0.1%	20%		
	C40 (933) *9	T412	Terminal 4 gain command (torque/magnetic flux)	0 to 400%	0.1%	150%		
	C41 (933) *9	T413	Terminal 4 gain (torque/magnetic flux)	0 to 300%	0.1%	100%		
	C42 (934) *9	A630	PID display bias coefficient	0 to 500, 9999	0.01	9999		
	C43 (934) *9	A631	PID display bias analog value	0 to 300%	0.1%	20%		
	C44 (935) *9	A632	PID display gain coefficient	0 to 500, 9999	0.01	9999		
C45 (935) *9	A633	PID display gain analog value	0 to 300%	0.1%	100%			
—	977	E302	Input voltage mode selection	0 to 2	1	0		
—	989	E490	Parameter copy alarm release	10 *2	1	10 *2		
				100 *3		100 *3		
PU	990	E104	PU buzzer control	0, 1	1	1		
	991	E105	PU contrast adjustment	0 to 63	1	58		
Monitor function	992	M104	Operation panel setting dial push monitor selection	0 to 3, 5 to 14, 17, 18, 20, 23 to 25, 34, 38, 40 to 45, 50 to 57, 61, 62, 64, 67 to 69, 81 to 96, 98, 100	1	0		
—	997	H103	Fault initiation	0 to 255, 9999	1	9999		
—	998	E430	PM parameter initialization <i>Simple</i>	0, 12, 14, 112, 114, 8009, 8109, 9009, 9109 *10*11	1	0		
				0, 8009, 8109, 9009, 9109 *12				
—	999	E431	Automatic parameter setting <i>Simple</i>	1, 2, 10, 11, 12, 13, 20, 21, 9999	1	9999		
—	1000	E108	Direct setting selection	0 to 2	1	0		
—	1002	C150	Lq tuning target current adjustment coefficient	50 to 150%, 9999	0.1%	9999		

Function	Pr.	Pr. group	Name	Setting range	Minimum setting increments	Initial value		Customer setting
						FM	CA	
Clock function	1006	E020	Clock (year)	2000 to 2099	1	2000		
	1007	E021	Clock (month, day)	1/1 to 12/31	1	101		
	1008	E022	Clock (hour, minute)	0:00 to 23:59	1	0		
—	1013 *14	H323	Running speed after emergency drive retry reset	0 to 590 Hz	0.01 Hz	60 Hz	50 Hz	
—	1015	A607	Integral stop selection at limited frequency	0, 1, 10, 11	1	0		
—	1016	H021	PTC thermistor protection detection time	0 to 60 s	1 s	0 s		
—	1018	M045	Monitor with sign selection	0, 1, 9999	1	9999		
Trace function	1020	A900	Trace operation selection	0 to 4	1	0		
	1021	A901	Trace mode selection	0 to 2	1	0		
	1022	A902	Sampling cycle	0 to 9	1	2		
	1023	A903	Number of analog channels	1 to 8	1	4		
	1024	A904	Sampling auto start	0, 1	1	0		
	1025	A905	Trigger mode selection	0 to 4	1	0		
	1026	A906	Number of sampling before trigger	0 to 100%	1%	90%		
	1027	A910	Analog source selection (1ch)	1 to 3, 5 to 14, 17, 18, 20, 23, 24, 34, 40 to 42, 52 to 54, 61, 62, 64, 67 to 69, 81 to 96, 98, 201 to 213, 230 to 232, 237, 238	1	201		
	1028	A911	Analog source selection (2ch)			202		
	1029	A912	Analog source selection (3ch)			203		
	1030	A913	Analog source selection (4ch)			204		
	1031	A914	Analog source selection (5ch)			205		
	1032	A915	Analog source selection (6ch)			206		
	1033	A916	Analog source selection (7ch)			207		
	1034	A917	Analog source selection (8ch)			208		
	1035	A918	Analog trigger channel	1 to 8	1	1		
	1036	A919	Analog trigger operation selection	0, 1	1	0		
	1037	A920	Analog trigger level	600 to 1400	1	1000		
	1038	A930	Digital source selection (1ch)	1 to 255	1	1		
	1039	A931	Digital source selection (2ch)			2		
	1040	A932	Digital source selection (3ch)			3		
	1041	A933	Digital source selection (4ch)			4		
	1042	A934	Digital source selection (5ch)			5		
1043	A935	Digital source selection (6ch)	6					
1044	A936	Digital source selection (7ch)	7					
1045	A937	Digital source selection (8ch)	8					
1046	A938	Digital trigger channel	1 to 8	1	1			
1047	A939	Digital trigger operation selection	0, 1	1	0			
—	1048	E106	Display-off waiting time	0 to 60 min	1 min	0 min		
—	1049	E110	USB host reset	0, 1	1	0		
Monitor function	1106	M050	Torque monitor filter	0 to 5 s, 9999	0.01 s	9999		
	1107	M051	Running speed monitor filter	0 to 5 s, 9999	0.01 s	9999		
	1108	M052	Excitation current monitor filter	0 to 5 s, 9999	0.01 s	9999		

Function	Pr.	Pr. group	Name	Setting range	Minimum setting increments	Initial value		Customer setting
						FM	CA	
PID control	1132	A626	Pre-charge change increment amount	0 to 100%, 9999	0.01%	9999		
	1133	A666	Second pre-charge change increment amount	0 to 100%, 9999	0.01%	9999		
	1136	A670	Second PID display bias coefficient	0 to 500, 9999	0.01	9999		
	1137	A671	Second PID display bias analog value	0 to 300%	0.1%	20%		
	1138	A672	Second PID display gain coefficient	0 to 500, 9999	0.01	9999		
	1139	A673	Second PID display gain analog value	0 to 300%	0.1%	100%		
	1140	A664	Second PID set point/deviation input selection	1 to 5	1	2		
	1141	A665	Second PID measured value input selection	1 to 5, 101 to 105	1	3		
	1142	A640	Second PID unit selection	0 to 43, 9999	1	9999		
	1143	A641	Second PID upper limit	0 to 100%, 9999	0.1%	9999		
	1144	A642	Second PID lower limit	0 to 100%, 9999	0.1%	9999		
	1145	A643	Second PID deviation limit	0 to 100%, 9999	0.1%	9999		
	1146	A644	Second PID signal operation selection	0 to 7, 10 to 17	1	0		
	1147	A661	Second output interruption detection time	0 to 3600 s, 9999	0.1 s	1 s		
	1148	A662	Second output interruption detection level	0 to 590 Hz	0.01 Hz	0 Hz		
1149	A663	Second output interruption cancel level	900 to 1100%	0.1%	1000%			
PLC function	1150 to 1199	A810 to A859	PLC function user parameters 1 to 50	0 to 65535	1	0		
PID gain tuning	1211	A690	PID gain tuning timeout time	1 to 9999 s	1 s	100 s		
	1212	A691	Step manipulated amount	900 to 1100%	0.1%	1000%		
	1213	A692	Step response sampling cycle	0.01 to 600 s	0.01 s	1 s		
	1214	A693	Timeout time after the maximum slope	1 to 9999 s	1 s	10 s		
	1215	A694	Limit cycle output upper limit	900 to 1100%	0.1%	1100%		
	1216	A695	Limit cycle output lower limit	900 to 1100%	0.1%	1000%		
	1217	A696	Limit cycle hysteresis	0.1 to 10%	0.1%	1%		
	1218	A697	PID gain tuning setting	0, 100 to 102, 111, 112, 121, 122, 200 to 202, 211, 212, 221, 222	1	0		
1219	A698	PID gain tuning start/status	(0), 1, 8, (9, 90 to 96)	1	0			
—	1300 to 1343	N500 to N543	Communication option parameters. For details, refer to the Instruction Manual of the option.					
—	1346	A457	PID lower limit operation detection time	0 to 900 s, 9999	1	9999		
—	1350 to 1359	N550 to N559	Communication option parameters. For details, refer to the Instruction Manual of the option.					

Function	Pr.	Pr. group	Name	Setting range	Minimum setting increments	Initial value		Customer setting
						FM	CA	
PID control enhanced functions	1361	A440	Detection time for PID output hold	0 to 900 s	0.1 s	5 s		
	1362	A441	PID output hold range	0 to 50%, 9999	0.1%	9999		
	1363	A447	PID priming time	0 to 360 s, 9999	0.1 s	9999		
	1364	A448	Stirring time during sleep	0 to 3600 s	0.1 s	15 s		
	1365	A449	Stirring interval time	0 to 1000 h	0.1 h	0 h		
	1366	A627	Sleep boost level	0 to 100%, 9999	0.01%	9999		
	1367	A628	Sleep boost waiting time	0 to 360 s	0.1 s	0 s		
	1368	A629	Output interruption cancel time	0 to 360 s	0.1 s	0 s		
	1369	A446	Check valve closing completion frequency	0 to 120 Hz, 9999	0.01 Hz	9999		
	1370	A442	Detection time for PID limiting operation	0 to 900 s	0.1 s	0 s		
	1371	A443	PID upper/lower limit pre-warning level range	0 to 50%, 9999	0.1%	9999		
	1372	A444	PID measured value control set point change amount	0 to 50%	0.01%	5%		
	1373	A445	PID measured value control set point change rate	0 to 100%	0.01%	0%		
	1374	A450	Auxiliary pressure pump operation starting level	900 to 1100%	0.1%	1000%		
	1375	A451	Auxiliary pressure pump operation stopping level	900 to 1100%	0.1%	1000%		
	1376	A414	Auxiliary motor stopping level	0 to 100%, 9999	0.1%	9999		
	1377	A452	PID input pressure selection	1 to 3, 9999	1	9999		
	1378	A453	PID input pressure warning level	0 to 100%	0.1%	20%		
	1379	A454	PID input pressure fault level	0 to 100%, 9999	0.1%	9999		
	1380	A455	PID input pressure warning set point change amount	0 to 100%	0.01%	5%		
1381	A456	PID input pressure fault operation selection	0, 1	1	0			
-	1410	A170	Starting times lower 4 digits	0 to 9999	1	0		
-	1411	A171	Starting times upper 4 digits	0 to 9999	1	0		
-	1412	C135	Motor induced voltage constant (phi f) exponent	0 to 2, 9999	1	9999		
-	1413	C235	Second motor induced voltage constant (phi f) exponent	0 to 2, 9999	1	9999		
PID gain tuning	1460	A683	PID multistage set point 1	0 to 100%, 9999	0.01%	9999		
	1461	A684	PID multistage set point 2	0 to 100%, 9999	0.01%	9999		
	1462	A685	PID multistage set point 3	0 to 100%, 9999	0.01%	9999		
	1463	A686	PID multistage set point 4	0 to 100%, 9999	0.01%	9999		
	1464	A687	PID multistage set point 5	0 to 100%, 9999	0.01%	9999		
	1465	A688	PID multistage set point 6	0 to 100%, 9999	0.01%	9999		
	1466	A689	PID multistage set point 7	0 to 100%, 9999	0.01%	9999		
Cleaning	1469	A420	Number of cleaning times monitor	0 to 255	1	0		
	1470	A421	Number of cleaning times setting	0 to 255	1	0		
	1471	A422	Cleaning trigger selection	0 to 15	1	0		
	1472	A423	Cleaning reverse rotation frequency	0 to 590 Hz	0.01 Hz	30 Hz		
	1473	A424	Cleaning reverse rotation operation time	0 to 3600 s	0.1 s	5 s		
	1474	A425	Cleaning forward rotation frequency	0 to 590 Hz, 9999	0.01 Hz	9999		
	1475	A426	Cleaning forward rotation operation time	0 to 3600 s, 9999	0.1 s	9999		
	1476	A427	Cleaning stop time	0 to 3600 s	0.1 s	5 s		
	1477	A428	Cleaning acceleration time	0 to 3600 s, 9999	0.1 s	9999		
	1478	A429	Cleaning deceleration time	0 to 3600 s, 9999	0.1 s	9999		
	1479	A430	Cleaning time trigger	0 to 6000 h	0.1 h	0 h		

Function	Pr.	Pr. group	Name	Setting range	Minimum setting increments	Initial value		Customer setting
						FM	CA	
Load characteristics fault detection	1480	H520	Load characteristics measurement mode	0, 1 (2 to 5, 81 to 85)	1	0		
	1481	H521	Load characteristics load reference 1	0 to 400%, 8888, 9999	0.1%	9999		
	1482	H522	Load characteristics load reference 2	0 to 400%, 8888, 9999	0.1%	9999		
	1483	H523	Load characteristics load reference 3	0 to 400%, 8888, 9999	0.1%	9999		
	1484	H524	Load characteristics load reference 4	0 to 400%, 8888, 9999	0.1%	9999		
	1485	H525	Load characteristics load reference 5	0 to 400%, 8888, 9999	0.1%	9999		
	1486	H526	Load characteristics maximum frequency	0 to 590 Hz	0.01 Hz	60 Hz	50 Hz	
	1487	H527	Load characteristics minimum frequency	0 to 590 Hz	0.01 Hz	6 Hz		
	1488	H531	Upper limit warning detection width	0 to 400%, 9999	0.1%	20%		
	1489	H532	Lower limit warning detection width	0 to 400%, 9999	0.1%	20%		
	1490	H533	Upper limit fault detection width	0 to 400%, 9999	0.1%	9999		
	1491	H534	Lower limit fault detection width	0 to 400%, 9999	0.1%	9999		
1492	H535	Load status detection signal delay time / load reference measurement waiting time	0 to 60 s	0.1 s	1 s			
–	1499	E415	Parameter for manufacturer setting. Do not set.					
Clear parameters	Pr.CLR		Parameter clear	(0), 1	1	0		
	ALL.CL		All parameter clear	(0), 1	1	0		
	Err.CL		Fault history clear	(0), 1	1	0		
–	Pr.CPY	Parameter copy		(0), 1 to 3	1	0		
–	Pr.CHG	Initial value change list		–	1	0		
–	IPM	IPM initialization		0, 12, 14	1	0		
–	AUTO	Automatic parameter setting		–	–	–		
–	Pr.MD	Group parameter setting		(0), 1, 2	1	0		

- *1 Differ according to capacities.
6%: FR-F820-00046(0.75K), FR-F840-00023(0.75K)
4%: FR-F820-00077(1.5K) to FR-F820-00167(3.7K), FR-F840-00038(1.5K) to FR-F840-00083(3.7K)
3%: FR-F820-00250(5.5K), FR-F820-00340(7.5K), FR-F840-00126(5.5K), FR-F840-00170(7.5K)
2%: FR-F820-00490(11K) to FR-F820-01540(37K), FR-F840-00250(11K) to FR-F840-00770(37K)
1.5%: FR-F820-01870(45K), FR-F820-02330(55K), FR-F840-00930(45K), FR-F840-01160(55K)
1%: FR-F820-03160(75K) or higher, FR-F840-01800(75K) or higher
- *2 The setting range or initial value for the FR-F820-02330(55K) or lower and FR-F840-01160(55K) or lower.
- *3 The setting range or initial value for the FR-F820-03160(75K) or higher and FR-F840-01800(75K) or higher.
- *4 The initial value for the FR-F820-00340(7.5K) or lower and FR-F840-00170(7.5K) or lower.
- *5 The initial value for the FR-F820-00490(11K) or higher and FR-F840-00250(11K) or higher.
- *6 Differ according to capacities.
4%: FR-F820-00340(7.5K) or lower, FR-F840-00170(7.5K) or lower
2%: FR-F820-00490(11K) to FR-F820-02330(55K), FR-F840-00250(11K) to FR-F840-01160(55K)
1%: FR-F820-03160(75K) or higher, FR-F840-01800(75K) or higher
- *7 The value for the 200 V class.
- *8 The value for the 400 V class.
- *9 The parameter number in parentheses is the one for use with the LCD operation panel and the parameter unit.
- *10 The setting range or initial value for the standard model.
- *11 The setting range or initial value for the separated converter type.
- *12 The setting range or initial value for the IP55 compatible model.
- *13 The setting is available for the standard model and the separated converter type only.
- *14 The setting is available for the standard model and the IP55 compatible model only.
- *15 The setting is available when the PLC function is enabled.
- *16 The setting range differs for the FR-F800-E. (Refer to **page 83**.)
- *17 The setting is not available for the FR-F800-E.



● List of parameters for Ethernet communication in the FR-F800-E (by parameter number)

The following table shows the extended parameters for the FR-F800-E as compared to the RS-485 communication inverters. Set the parameters according to the application.

Function	Pr.	Pr. group	Name	Setting range	Minimum setting increments	Initial value	Customer setting
Output terminal function assignment	190	M400	RUN terminal function selection	242, 342 *1	1	0	
	191	M401	SU terminal function selection		1	1	
	192	M402	IPF terminal function selection		1	2 *2 9999 *3	
	193	M403	OL terminal function selection		1	3	
	194	M404	FU terminal function selection		1	4	
	195	M405	ABC1 terminal function selection		1	99	
	196	M406	ABC2 terminal function selection		1	9999	
Ethernet communication	349	—	Communication reset selection/Ready bit status selection/Reset selection after inverter faults are cleared/DriveControl writing restriction selection	0, 1, 100, 101, 1000, 1001, 1100, 1101, 10000, 10001, 10100, 10101, 11000, 11001, 11100, 11101	1	0	
		N010	Communication reset selection	0, 1	1	0	
		N240	Ready bit status selection	0, 1	1	0	
		N241*4	Reset selection after inverter faults are cleared	0, 1	1	0	
		N242*4	DriveControl writing restriction selection	0, 1	1	0	
	541	N100	Frequency command sign selection	0, 1	1	0	
	544	N103	CC-Link extended setting	0, 1, 12, 14, 18, 24, 28, 100, 112, 114, 118, 128	1	0	
	550	D012	NET mode operation command source selection	0, 1, 5, 9999	1	9999	
	551	D013	PU mode operation command source selection	1 to 3, 5, 9999	1	9999	
	1124	N681	Station number in inverter-to-inverter link	0 to 5, 9999	1	9999	
	1125	N682	Number of inverters in inverter-to-inverter link system	2 to 6	1	2	
	1424	N650	Ethernet communication network number	1 to 239	1	1	
	1425	N651	Ethernet communication station number	1 to 120	1	1	
	1426	N641	Link speed and duplex mode selection	0 to 4	1	0	
	1427	N630	Ethernet function selection 1	502, 5000 to 5002, 5006 to 5008, 5010 to 5013, 9999, 45237, 47808, 61450	1	5001	
	1428	N631	Ethernet function selection 2	502, 5000 to 5002, 5006 to 5008, 5010 to 5013, 9999, 45237, 47808, 61450	1	45237	
	1429	N632	Ethernet function selection 3	502, 5000 to 5002, 5006 to 5008, 5010 to 5013, 9999, 45237, 47808, 61450	1	9999	
	1431	N643	Ethernet signal loss detection function selection	0 to 3	1	0	
	1432	N644	Ethernet communication check time interval	0 to 999.8 s, 9999	0.1 s	9999	
	1434	N600	IP address 1 (Ethernet)	0 to 255	1	192	
	1435	N601	IP address 2 (Ethernet)	0 to 255	1	168	
	1436	N602	IP address 3 (Ethernet)	0 to 255	1	50	
	1437	N603	IP address 4 (Ethernet)	0 to 255	1	1	
	1438	N610	Subnet mask 1	0 to 255	1	255	
	1439	N611	Subnet mask 2	0 to 255	1	255	
	1440	N612	Subnet mask 3	0 to 255	1	255	
	1441	N613	Subnet mask 4	0 to 255	1	0	
	1442	N660	IP filter address 1 (Ethernet)	0 to 255	1	0	
	1443	N661	IP filter address 2 (Ethernet)	0 to 255	1	0	
	1444	N662	IP filter address 3 (Ethernet)	0 to 255	1	0	
	1445	N663	IP filter address 4 (Ethernet)	0 to 255	1	0	
	1446	N664	IP filter address 2 range specification (Ethernet)	0 to 255, 9999	1	9999	
	1447	N665	IP filter address 3 range specification (Ethernet)	0 to 255, 9999	1	9999	
	1448	N666	IP filter address 4 range specification (Ethernet)	0 to 255, 9999	1	9999	
	1449	N670	Ethernet command source selection IP address 1	0 to 255	1	0	
1450	N671	Ethernet command source selection IP address 2	0 to 255	1	0		
1451	N672	Ethernet command source selection IP address 3	0 to 255	1	0		
1452	N673	Ethernet command source selection IP address 4	0 to 255	1	0		
1453	N674	Ethernet command source selection IP address 3 range specification	0 to 255, 9999	1	9999		
1454	N675	Ethernet command source selection IP address 4 range specification	0 to 255, 9999	1	9999		
1455	N642	Keepalive time	1 to 7200 s	1 s	3600 s		

*1 Setting values not shown are the same as those of RS-485 communication inverters.

*2 The initial value is for standard models.

*3 The initial value is for separated converter types.

*4 The setting is available when a compatible HMS network option is installed. For details, refer to the Instruction Manual (Detailed).

● Converter unit parameter list (by parameter number)

Set the necessary parameters to meet the load and operational specifications. Parameter setting, change and check can be performed from the operation panel (FR-DU08).

Function	Pr.	Pr. group	Name	Setting range	Minimum setting increments	Initial value	Customer setting					
—	30	E300	Reset selection during power supply to main circuit	0, 100	1	0						
Automatic restart	57	A702	Restart selection	0, 9999	1	9999						
	65	H300	Retry selection	0 to 4	1	0						
Retry	67	H301	Number of retries at fault occurrence	0 to 10, 101 to 110	1	0						
	68	H302	Retry waiting time	0.1 to 600 s	0.1 s	1 s						
	69	H303	Retry count display erase	0	1	0						
—	75	—	Reset selection/disconnected PU detection/ reset limit	14 to 17, 114 to 117	1	14						
		E100	Reset selection	0, 1		0						
		E101	Disconnected PU detection									
		E107	Reset limit									
—	77	E400	Parameter write selection	1, 2	1	2						
PU connector communication	117	N020	PU communication station number	0 to 31	1	0						
	118	N021	PU communication speed	48, 96, 192, 384, 576, 768, 1152	1	192						
	119	—	PU communication stop bit length / data length	0, 10	1	1						
		N022	PU communication data length	0, 1		0						
		N023	PU communication stop bit length	0, 1		1						
	120	N024	PU communication parity check	0 to 2	1	2						
	121	N025	Number of PU communication retries	0 to 10, 9999	1	1						
	122	N026	PU communication check time interval	0, 0.1 to 999.8 s, 9999	0.1 s	9999						
	123	N027	PU communication waiting time setting	0 to 150 ms, 9999	1 ms	9999						
124	N028	PU communication CR/LF selection	0 to 2	1	1							
—	161	E200	Key lock operation selection	0, 10	1	0						
—	168	E000	Parameter for manufacturer setting.									
		E080										
—	169	E001										
		E081										
Cumulative monitor clear	170	M020						Watt-hour meter clear	0, 10, 9999	1	9999	
Input terminal function assignment	178	T700						RDI terminal function selection	7, 62, 9999	1	9999	
	187	T709	OH terminal function selection	7								
	189	T711	RES terminal function selection	62								
Output terminal function assignment	190	M400	RDB terminal function selection	2, 8, 11, 17, 25, 26, 64, 68, 90, 94, 95, 98, 99, 102, 108, 111, 125, 126, 164, 168, 190, 194, 195, 198, 199, 206, 207, 209, 210, 214, 306, 307, 309, 310, 9999	1	111						
	191	M401	RDA terminal function selection		1	11						
	192	M402	IPF terminal function selection		1	2						
	193	M403	RSO terminal function selection		1	209						
	194	M404	FAN terminal function selection		1	25						
195	M405	ABC1 terminal function selection	1	99								
—	248	A006	Self power management selection	0 to 2	1	0						

Function	Pr.	Pr. group	Name	Setting range	Minimum setting increments	Initial value	Customer setting	
Life check	255	E700	Life alarm status display	(0 to 15)	1	0		
	256	E701	Inrush current limit circuit life display	(0 to 100%)	1%	100%		
	257	E702	Control circuit capacitor life display	(0 to 100%)	1%	100%		
—	261	A730	Power failure stop selection	0, 1, 2, 21, 22	1	0		
—	268	M022	Monitor decimal digits selection	0, 1, 9999	1	9999		
—	269	E023	Parameter for manufacturer setting. Do not set.					
—	290	M044	Monitor negative output selection	0, 2, 4, 6	1	0		
Password function	296	E410	Password lock level	0 to 3, 5, 6, 100 to 103, 105, 106, 9999	1	9999		
	297	E411	Password lock/unlock	(0 to 5), 1000 to 9998, 9999	1	9999		
RS-485 communication	331	N030	RS-485 communication station number	0, 31 (0, 247)	1	0		
	332	N031	RS-485 communication speed	3, 6, 12, 24, 48, 96, 192, 384, 576, 768, 1152	1	96		
	333	—	RS-485 communication stop bit length / data length	0, 1, 10, 11	1	1		
		N032	RS-485 communication data length	0, 1	1	0		
		N033	RS-485 communication stop bit length	0, 1	1	1		
	334	N034	RS-485 communication parity check selection	0 to 2	1	2		
	335	N035	RS-485 communication retry count	0 to 10, 9999	1	1		
	336	N036	RS-485 communication check time interval	0 to 999.8 s, 9999	0.1 s	0 s		
	337	N037	RS-485 communication waiting time setting	0 to 150 ms, 9999	1 ms	9999		
	341	N038	RS-485 communication CR/LF selection	0 to 2	1	1		
	342	N001	Communication EEPROM write selection	0, 1	1	0		
343	N080	Communication error count	—	1	0			
Maintenance	503	E710	Maintenance timer 1	0 (1 to 9998)	1	0		
	504	E711	Maintenance timer 1 warning output set time	0 to 9998, 9999	1	9999		
—	539	N002	MODBUS RTU communication check time interval	0 to 999.8 s, 9999	0.1 s	9999		
Communication	549	N000	Protocol selection	0, 1	1	0		
—	563	M021	Energization time carrying-over times	(0 to 65535)	1	0		
—	598	H102	Undervoltage level	350 to 430 V, 9999	0.1 V	9999		
—	663	M060	Control circuit temperature signal output level	0 to 100°C	1°C	0°C		
Maintenance	686	E712	Maintenance timer 2	0 (1 to 9998)	1	0		
	687	E713	Maintenance timer 2 warning output set time	0 to 9998, 9999	1	9999		
	688	E714	Maintenance timer 3	0 (1 to 9998)	1	0		
	689	E715	Maintenance timer 3 warning output set time	0 to 9998, 9999	1	9999		
Monitor function	774	M101	Operation panel monitor selection 1	2, 8, 13, 20, 25, 43, 44, 55, 62, 98, 9999	1	9999		
	775	M102	Operation panel monitor selection 2		1	9999		
	776	M103	Operation panel monitor selection 3		1	9999		
Protective Functions	872	H201	Input phase loss protection selection	0, 1	1	0		

Function	Pr.	Pr. group	Name	Setting range	Minimum setting increments	Initial value	Customer setting
—	876	T723	OH input selection	0 to 2	1	0	
Free parameters	888	E420	Free parameter 1	0 to 9999	1	9999	
	889	E421	Free parameter 2	0 to 9999	1	9999	
Energy saving monitor	891	M023	Cumulative power monitor digit shifted times	0 to 4, 9999	1	9999	
PU	990	E104	PU buzzer control	0, 1	1	1	
Monitor function	992	M104	Operation panel setting dial push monitor selection	2, 8, 13, 20, 25, 43, 44, 55, 62, 98	1	8	
—	997	H103	Fault initiation	0 to 255, 9999	1	9999	
Clock function	1006	E020	Clock (year)	2000 to 2099	1	2000	
	1007	E021	Clock (month, day)	1/1 to 12/31	1	101	
	1008	E022	Clock (hour, minute)	0:00 to 23:59	1	0	
—	1048	E106	Display-off waiting time	0 to 60 min	1 min	0 min	
Clear parameters	Pr.CLR		Parameter clear	(0), 1	1	0	
	ALL.CL		All parameter clear	(0), 1	1	0	
	Err.CL		Fault history clear	(0), 1	1	0	
—	Pr.CPY		Parameter copy	(0), 1 to 3	1	0	
—	Pr.CHG		Initial value change list	—	1	0	
—	Pr.MD		Group parameter setting	(0), 1, 2	1	0	

Protective Functions

● The list of inverter protective functions

When the inverter detects a fault, depending on the nature of the fault, the operation panel displays an error message or warning, or a protective function activates to trip the inverter.

	Name	Description	Operation panel indication
Error message *2	Fault history	The operation panel stores the fault indications which appears when a protective function is activated to display the fault record for the past eight faults.	E-----
	Operation panel lock	Appears when operation was tried during operation panel lock.	HOLD
	Password locked	Appears when a password restricted parameter is read/written.	LOCd
	Parameter write error	Appears when an error occurred during parameter writing.	Er 1toEr 4 Er 8
	Copy operation error	Appears when an error occurred during parameter copying.	rE 1to-rE 8
	Error	Appears when the RES signal is on or the PU and inverter can not make normal communication.	Err.
Warning *3	Stall prevention (overcurrent)	Appears during overcurrent stall prevention.	OL
	Stall prevention (overvoltage)	Appears during overvoltage stall prevention. Appears while the regeneration avoidance function is activated.	oL
	Electronic thermal relay function pre-alarm	Appears when the electronic thermal O/L relay has reached 85% of the specified value.	TH
	PU stop	Appears if  is pressed in an operation mode other than the PU operation mode.	PS
	Continuous operation during communication fault *7	Appears when the operation continues while an error is occurring in the communication line or communication option (when Pr.502 = "4").	CF
	Parameter copy	Appears when parameter copy is performed between inverters FR-F820-02330(55K) or lower, FR-F840-01160(55K) or lower, FR-F820-03160(75K) or higher and FR-F840-01800(75K) or higher	CP
	Safety stop	Appears when safety stop function is activated (during output shutoff).	SA
	Maintenance signal output 1 to 3 *7	Appears when the inverter's cumulative energization time reaches or exceeds the parameter set value.	MF 1toMF 3
	USB host error	Appears when an excessive current flows into the USB A connector.	UF
	24 V external power supply operation	Flickers when the main circuit power supply is off and the 24 V external power supply is being input.	EV
	Load fault warning *7	Appears when the present load status deviates from the upper and lower limit warning detection width.	LdF
	Emergency drive in operation	Appears during emergency drive operation. (Standard models only)	Ed
	Ethernet communication fault	Appears when Ethernet communication is interrupted by physical factors. (This function is intended for the FR-F800-E only.)	EHR
	Alarm *4	Fan alarm	Appears when the cooling fan remains stopped when operation is required or when the speed has decreased.
Internal fan alarm		Appears when the internal air circulation fan fails or approaches the replacement time. (IP55 compatible model only)	FN2
Fault *5	Overcurrent trip during acceleration	Appears when an overcurrent occurred during acceleration.	E. OC 1
	Overcurrent trip during constant speed	Appears when an overcurrent occurred during constant speed operation.	E. OC 2
	Overcurrent trip during deceleration or stop	Appears when an overcurrent occurred during deceleration and at a stop.	E. OC 3
	Regenerative overvoltage trip during acceleration	Appears when an overvoltage occurred during acceleration.	E. OV 1
	Regenerative overvoltage trip during constant speed	Appears when an overvoltage occurred during constant speed operation.	E. OV 2
	Regenerative overvoltage trip during deceleration or stop	Appears when an overvoltage occurred during deceleration and at a stop.	E. OV 3
	Inverter overload trip (electronic thermal relay function) *1	Appears when the electronic thermal relay function for inverter element protection was activated.	E. THr
	Motor overload trip (electronic thermal relay function) *1	Appears when the electronic thermal relay function for motor protection was activated.	E. THM
	Heat sink overheat	Appears when the heat sink overheated.	E. FIN
	Instantaneous power failure	Appears when an instantaneous power failure occurred at an input power supply. (Standard models only)	E. I PF
	Undervoltage	Appears when the main circuit DC voltage became low. (Standard models only)	E. UVr
	Input phase loss *7	Appears if one of the three phases on the inverter input side opened. (Standard models only)	E. I LF
	Stall prevention stop	Appears 3 s after the output frequency is reduced to the reference value by the stall prevention (torque limit) operation.	E. OLF
	Loss of synchronism detection	The inverter trips when the motor operation is not synchronized. (This function is only available under PM sensorless vector control.)	E. SOF
	Upper limit fault detection *7	Appears when the present load status exceeds the upper limit warning detection width.	E. LUP
	Lower limit fault detection *7	Appears when the present load status falls below the lower limit warning detection width.	E. LDn
	Output side earth (ground) fault overcurrent	Appears when an earth (ground) fault occurred on the Inverter's output side.	E. GF
	Output phase loss	Appears if one of the three phases on the inverter output side opened.	E. LF
External thermal relay operation *6	Appears when the external thermal relay connected to the terminal OH is activated.	E. OHR	

Name	Description	Operation panel indication
PTC thermistor operation	The inverter trips if resistance of the PTC thermistor connected between the terminal 2 and terminal 10 has reached the Pr.561 PTC thermistor protection level setting or higher.	E. PTC
Option fault	Appears when an AC power supply is connected to terminals R/L1, S/L2, and T/L3 while Pr.30 = "2" (connecting a high power factor converter or power regeneration common converter).	E. OPF
Communication option fault	Appears when a communication line error occurs in the communication option.	E. OP1
Internal storage device fault	Activated by an inverter reset if writing data fails due to power-OFF or a data fault occurs in the storage device during parameter operations*8.	E. PEG
Parameter storage device fault (control circuit board)	Appears when operation of the element where parameters stored became abnormal. (control board)	E. PE
PU disconnection	Appears when a communication error between the PU and inverter occurred, the communication interval exceeded the permissible time during the RS-485 communication with the PU connector, or communication errors exceeded the number of retries during the RS-485 communication.	E. PUE
Retry count excess *7	Appears when the operation was not restarted within the set number of retries.	E. REF
Parameter storage device fault (main circuit board)	Appears when operation of the element where parameters stored became abnormal. (main circuit board)	E. PE2
CPU fault	Appears during the CPU and peripheral circuit errors occurred.	E. CPU E. 5 to E. 7
Operation panel power supply short circuit/RS-485 terminals power supply short circuit	Appears when the RS-485 terminal power supply or operation panel power supply was shorted.	E. CFE
24 VDC power fault	When the 24 VDC power output via the terminal PC is shorted, or when the external 24 VDC power supplied to the terminal +24 is not enough, this function shuts off the power output.	E. P24
Abnormal output current detection *7	Appears when the output current is out of the output current detection range set by parameters.	E. CDO
Inrush current limit circuit fault	Appears when the resistor of the inrush current limit circuit overheated. (Standard models only)	E. IOH
Communication fault (inverter)	Appears when a communication error occurred during the RS-485 communication with the RS-485 terminals. (This function is not intended for the FR-F800-E.)	E. SER
Analog input fault	Appears when 30 mA or more is input or a voltage (7.5 V or more) is input with the terminal 2/4 set to current input.	E. AIE
USB communication fault	Appears when USB communication error occurred.	E. USB
Safety circuit fault	The inverter trips when a safety circuit fault occurs.	E. SAF
Overspeed occurrence *7	Indicates that the motor speed has exceeded the overspeed setting level (Pr.374).	E. OS
Abnormal internal temperature	The inverter trips when the temperature inside the inverter becomes high. (IP55 compatible model only)	E. IAH
4 mA input fault *7	The inverter trips when the analog input current is 2 mA or less for the time set in Pr.778 4 mA input check filter .	E. LCI
Pre-charge fault *7	The inverter trips when the pre-charge time exceeds Pr.764 Pre-charge time limit . The inverter trips when the measured value exceeds Pr.763 Pre-charge upper detection level during pre-charging.	E. PCH
PID signal fault *7	The inverter trips if the measured value exceeds the PID upper limit or PID lower limit parameter setting, or the absolute deviation value exceeds the PID deviation parameter setting during PID control.	E. PID
Option fault	The inverter trips when a contact fault is found between the inverter and the plug-in option, or when the communication option is not connected to the connector 1.	E. 1 to E. 3
Ethernet communication fault	If Ethernet communication is interrupted by physical factors or a no-communication state persists for the permissible time or longer, the inverter stops its output. (This function is intended for the FR-F800-E only.)	E. EHR
Internal circuit fault	Appears when an internal circuit error occurred.	E. bE
		E. Pbf
		E. 13
User definition error by the PLC function	Appears when the values 16 to 20 are set in the device SD1214 with the program operation of the PLC function.	E. 16 to E. 20

*1 Resetting the inverter initializes the internal cumulative heat value of the electronic thermal O/L relay function.
 *2 The error message shows an operational error. The inverter output is not shut off.
 *3 Warnings are messages given before faults occur. The inverter output is not shut off.
 *4 Alarm warn the operator of failures with output signals. The inverter output is not shut off.
 *5 When faults occur, the protective functions are activated to shut off the inverter output and output the alarms.
 *6 The external thermal operates only when the OH signal is set in **Pr.178 to Pr.189 (input terminal function selection)**.
 *7 This protective function is not available in the initial status.
 *8 For example, when parameter clear, All parameter clear, Parameter copy, or offline auto tuning is performed in the inverter, or when parameter batch write is performed in FR Configurator2.

● The list of converter unit protective functions

When the converter unit detects a fault, depending on the nature of the fault, the operation panel displays an error message or warning, or a protective function activates to trip the inverter.

	Name	Description	Operation panel indication
Error message *2	Fault history	The operation panel stores the fault indications which appears when a protective function is activated to display the fault record for the past eight faults.	E-----
	Operation panel lock	Appears when operation was tried during operation panel lock.	HOLD
	Password locked	Appears when a password restricted parameter is read/written.	LOCd
	Parameter write error	Appears when an error occurred during parameter writing.	Er 1
	Copy operation error	Appears when an error occurred during parameter copying.	rE 1 to rE 4
	Error	Appears when the RES signal is on or the PU and converter unit can not make normal communication.	Err.
Warning *3	Electronic thermal relay function pre-alarm	Appears when the electronic thermal O/L relay has reached 85% of the specified value.	TH
	Maintenance signal output 1 to 3 *7	Appears when the converter unit's cumulative energization time reaches or exceeds the parameter set value.	MF 1 to MF 3
	24 V external power supply operation	Flickers when the main circuit power supply is off and the 24 V external power supply is being input.	EV
Alarm *4	Fan alarm	Appears when the cooling fan remains stopped when operation is required or when the speed has decreased.	FN
Fault *5	Overvoltage trip	Appears when the converter unit's internal main circuit DC voltage exceeds the specified value.	E. OVF
	Converter overload trip (electronic thermal relay function) *1	Appears when the electronic thermal O/L relay of the converter unit diode module is activated.	E. FHC
	Heat sink overheat	Appears when the heat sink overheated.	E. FIN
	Instantaneous power failure	Appears when an instantaneous power failure occurred at an input power supply.	E. IPF
	Undervoltage	Appears when power supply voltage of the converter unit is set at a low level.	E. UVF
	Input phase loss *7	Appears if one of the three phases on the converter unit input side opened.	E. ILF
	External thermal relay operation *6	Appears when the external thermal relay connected to the terminal OH is activated.	E. OHF
	Parameter storage device fault (control circuit board)	Appears when operation of the element where parameters stored became abnormal. (control board)	E. PE
	PU disconnection	Appears when a communication error between the PU and inverter occurred, the communication interval exceeded the permissible time during the RS-485 communication with the PU connector, or communication errors exceeded the number of retries during the RS-485 communication.	E. PUE
	Retry count excess *7	Appears when the operation was not restarted within the set number of retries.	E. REF
	Parameter storage device fault (main circuit board)	Appears when operation of the element where parameters stored became abnormal. (main circuit board)	E. PE2
	CPU fault	Appears during the CPU and peripheral circuit errors occurred.	E. CPU E. 5 to E. 7
	Operation panel power supply short circuit/RS-485 terminals power supply short circuit	Appears when the RS-485 terminal power supply or operation panel power supply was shorted.	E. CFE
	24 VDC power fault	When the 24 VDC power output via the terminal PC is shorted, or when the external 24 VDC power supplied to the terminal +24 is not enough, this function shuts off the power output.	E. P24
	Inrush current limit circuit fault	Appears when the resistor of the inrush current limit circuit overheated.	E. IOH
	Communication fault (inverter)	Appears when a communication error occurred during the RS-485 communication with the RS-485 terminals.	E. SER
	Internal circuit fault	Appears when an internal circuit error occurred.	E. Pbf
			E. 13
Option fault	The inverter trips if a plug-in option is disconnected while the converter unit power is ON.	E. 1	

*1 Resetting the converter unit initializes the internal cumulative heat value of the electronic thermal O/L relay function.

*2 The error message shows an operational error. The inverter output is not shut off.

*3 Warnings are messages given before faults occur. The inverter output is not shut off.

*4 Alarm warn the operator of failures with output signals. The inverter output is not shut off.

*5 When faults occur, the protective functions are activated to shut off the inverter output and output the alarms.

*6 The external thermal operates only when the OH signal is set in **Pr.178, Pr.180, Pr.187 or Pr.189 (input terminal function selection)**.

*7 This protective function is not available in the initial status.

Option and Peripheral Devices

● Option List

By fitting the following options to the inverter, the inverter is provided with more functions.

Three plug-in options can be fitted at a time. (more than two same options and communication options can not be fitted)

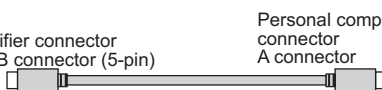
Name		Type	Applications, specifications, etc.	Applicable inverter	
Plug-in type	16-bit digital input	FR-A8AX	This input interface sets the high frequency accuracy of the inverter using an external BCD or binary digital signal. BCD code 3 digits (maximum 999) BCD code 4 digits (maximum 9999) Binary 12 bits (maximum FFFH) Binary 16 bits (maximum FFFFH)	Shared among all models	
	Digital output Extension analog output	FR-A8AY	Output signals provided with the inverter as standard are selected to output from the open collector. This option adds 2 different signals that can be monitored at the terminals AM0 and AM1, such as the output frequency, output voltage and output current. 20mADC or 10VDC meter can be connected.		
	Relay output	FR-A8AR	Output any three output signals available with the inverter as standard from the relay contact terminals.		
	Phase-synchronized bypass switching	FR-A8AVP	This option allows smooth switching of the motor power supply from the inverter output power to the commercial power.	400 V class	
		Phase detection transformer box			FR-A8VPB
	Communication	CC-Link IE TSN communication	FR-A8NCG	This option allows the inverter to be operated or monitored or the parameter setting to be changed from a computer or programmable controller.	Shared among all models
		CC-Link/IE field network communication	FR-A8NCE		
		CC-Link communication	FR-A8NC		
		DeviceNet communication	FR-A8ND		
		PROFIBUS-DP communication	FR-A8NP		
LONWORKS communication		FR-A8NL			
FL remote communication		FR-A8NF			
Control terminal	Screw terminal block	FR-A8TR	The screw type control circuit terminal block enables wiring using round crimping terminals.	Shared among all models *1	
Stand-alone shared	Liquid crystal display operation panel	FR-LU08	Graphical operation panel with liquid crystal display *2	Shared among all models	
	Parameter unit	FR-PU07	Interactive parameter unit with LCD display		
	Parameter unit with battery pack	FR-PU07BB(-L) *3	Enables parameter setting without supplying power to the inverter.		
	Parameter unit connection cable	FR-CB20□	Cable for connection of operation panel or parameter unit □ indicates a cable length. (1m, 3m, 5m)		
	USB cable	MR-J3USBCBL3M Cable length: 3 m			
	Operation panel connection connector	FR-ADP	Connector to connect the operation panel (FR-DU08) and connection cable.		
	Control circuit terminal block intercompatibility attachment	FR-A8TAT	An attachment for installing the control circuit terminal block of the FR-F700(P)/F500 series to that of the FR-F800 series	Shared among all models	
	Panel through attachment	FR-A8CN	The inverter heat sink section can be protruded outside of the rear of the enclosure. For the enclosure cut dimensions, refer to page 36 .	FR-F820-00105(2.2K) to FR-F820-04750(110K), FR-F840-00023(0.75K) to FR-F840-03610(160K) According to capacities	
	Intercompatibility attachment	FR-AAT	Attachment for replacing with the FR-F800 series using the installation holes of the FR-F700(P)/F500/A100E series.	According to capacities	
		FR-A5AT			
FR-F8AT					
AC reactor	FR-HAL	For harmonic current reduction and inverter input power factor improvement	According to capacities		
DC reactor	FR-HEL				
Line noise filter	FR-BSF01	For line noise reduction	Shared among all models		
	FR-BLF				

Name		Type	Applications, specifications, etc.	Applicable inverter	
Stand-alone shared	Brake unit		For increasing the braking capability of the inverter (for high-inertia load or negative load) Brake unit and resistor unit are used in combination	According to capacities	
	Resistor unit			FR-F820-02330(55K) or lower, FR-F840-01160(55K) or lower	
				FR-F820-03160(75K) or higher, FR-F840-01800(75K) or higher	
	Multifunction regeneration converter Dedicated stand-alone reactor Dedicated box-type reactor		FR-XC FR-XCL/ FR-XCG FR-XCB	One inverter can handle harmonic suppression and power regeneration. Functions that match the application can be selected by combining the converter with the dedicated reactor FR-XCB, FR-XCL, or FR-XCG.	According to capacities
	Power regeneration converter		MT- RC	Energy saving type high performance brake unit which can regenerate the braking energy generated by the motor to the power supply.	FR-F840-01800(75K) or higher
	High power factor converter		FR-HC2	The high power factor converter switches the converter section on/off to reshape an input current waveform into a sine wave, greatly suppressing harmonics. (Used in combination with the standard accessory.)	According to capacities
	Surge voltage suppression filter		FR-ASF FR-BMF	Filter for suppressing surge voltage on motor	FR-F840-01160(55K) or lower FR-F840-00126(5.5K) to FR-F840-00770(37K) According to capacities
	Sine wave filter	Reactor	MT- BSL (-HC)	Reduce the motor noise during inverter driving Use in combination with a reactor and a capacitor	FR-F820-03160(75K) or higher, FR-F840-01800(75K) or higher According to capacities
		Capacitor	MT- BSC		
	Others	Pilot generator		QVAH-10	Shared among all models
Deviation sensor		YVGC-500W-NS			
Analog frequency meter (64mm × 60mm)		YM206NRI 1mA			
Calibration resistor		RV24YN 10kΩ			
Inverter setup software (FR Configurator2)		SW1DND-FRC2-E			
Mobile app for inverters (FR Configurator Mobile)		—	Enables operation of inverters using smart phones or tablets.	FR-F800-E	

*1 Not available for the FR-F800-E.

*2 The battery (CR1216: a diameter of 12 mm, a height of 16 mm) is not bundled.

*3 To use a parameter unit with battery pack (FR-PU07BB) outside Japan, order a "FR-PU07BB-L" (parameter unit type indicated on the package has L at the end). Since batteries may conflict with laws in countries to be used (new EU Directive on batteries and accumulators, etc.), batteries are not enclosed with an FR-PU07BB.

● Phase-synchronized bypass switching

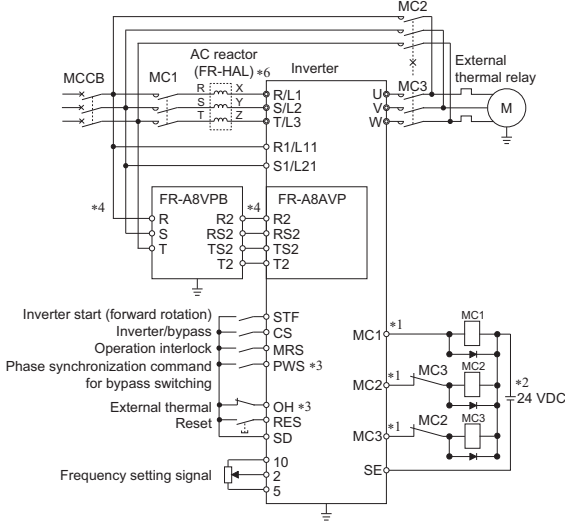
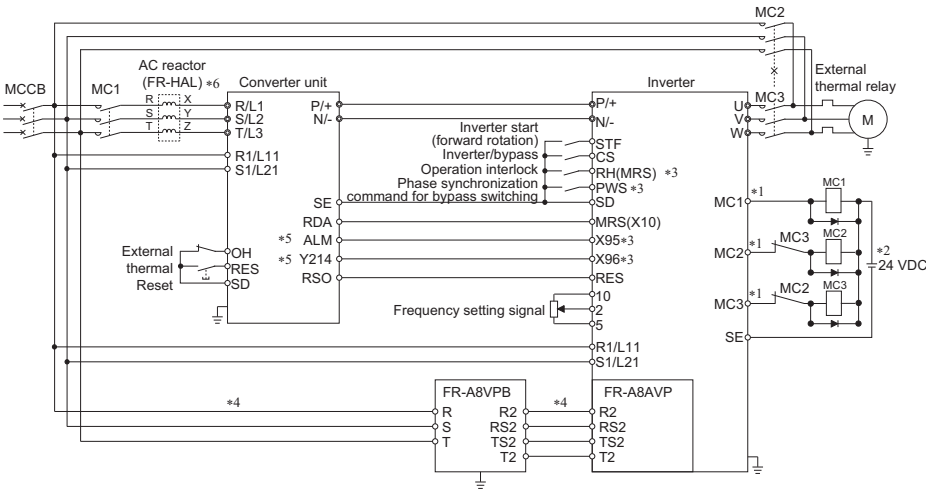
Name (model)	Specification and structure																	
<p data-bbox="135 920 320 999">Phase-synchronized bypass switching FR-A8AVP FR-A8VPB-H</p> 	<p data-bbox="352 280 1412 349">The phase-synchronized bypass switching function permits smooth switching of the motor power supply from the inverter output power to the commercial power. The shock caused by the switch is suppressed because the inverter output voltage phase is synchronized with the commercial power voltage phase. Use with a phase detection transformer box (FR-A8VPB-H).</p> <ul data-bbox="352 349 528 371" style="list-style-type: none"> • Connection diagram <p data-bbox="352 371 884 394"><<Example for the standard model or IP55 compatible mode>></p>  <p data-bbox="352 965 751 987"><<Example for the separated converter type>></p>  <p data-bbox="448 1525 1437 1570">*1 Be careful of the capacity of the sequence output terminals. The applied terminals differ depending on the settings of Pr.190 to Pr.196 (Output terminal function selection).</p> <table border="1" data-bbox="496 1574 1305 1682"> <thead> <tr> <th>Output terminal capacity</th> <th>Output terminal permissible load</th> </tr> </thead> <tbody> <tr> <td>Open collector output of inverter (RUN, SU, IPF, OL, FU)</td> <td>24 VDC 0.1 A</td> </tr> <tr> <td>Inverter relay output (A1-C1, B1-C1, A2-B2, B2-C2)</td> <td>230 VAC 0.3 A</td> </tr> <tr> <td>Relay output option (FR-A8AR)</td> <td>30 VDC 0.3 A</td> </tr> </tbody> </table> <p data-bbox="448 1693 1437 1738">*2 When connecting a DC power supply, insert a protective diode. When connecting an AC power supply, use the relay output option (FR-A8AR), and use contact outputs.</p> <p data-bbox="448 1738 1326 1760">*3 The applied terminals differ depending on the settings of Pr.180 to Pr.189 (Input terminal function selection).</p> <p data-bbox="448 1760 1070 1783">*4 Use the wires satisfying the following requirements for each wiring location.</p> <table border="1" data-bbox="496 1787 1305 1917"> <thead> <tr> <th>Wiring location</th> <th>Wire gauge (mm²)</th> <th>Total wiring length</th> </tr> </thead> <tbody> <tr> <td>Wiring between the power supply and the phase detection transformer box</td> <td>2</td> <td>10 m or less</td> </tr> <tr> <td>Wiring between the phase detection transformer box and the inverter</td> <td>0.75 to 1.25</td> <td>5 m or less</td> </tr> </tbody> </table> <p data-bbox="448 1928 1422 1973">*5 To use the signal, assign the function to the output terminal using Pr.190 to Pr.195 (Output terminal function selection) in the converter unit. Always set the negative logic for the ALM signal.</p> <p data-bbox="448 1973 1070 1995">*6 When using an AC reactor, connect the reactor as specified in the diagram.</p>	Output terminal capacity	Output terminal permissible load	Open collector output of inverter (RUN, SU, IPF, OL, FU)	24 VDC 0.1 A	Inverter relay output (A1-C1, B1-C1, A2-B2, B2-C2)	230 VAC 0.3 A	Relay output option (FR-A8AR)	30 VDC 0.3 A	Wiring location	Wire gauge (mm ²)	Total wiring length	Wiring between the power supply and the phase detection transformer box	2	10 m or less	Wiring between the phase detection transformer box and the inverter	0.75 to 1.25	5 m or less
Output terminal capacity	Output terminal permissible load																	
Open collector output of inverter (RUN, SU, IPF, OL, FU)	24 VDC 0.1 A																	
Inverter relay output (A1-C1, B1-C1, A2-B2, B2-C2)	230 VAC 0.3 A																	
Relay output option (FR-A8AR)	30 VDC 0.3 A																	
Wiring location	Wire gauge (mm ²)	Total wiring length																
Wiring between the power supply and the phase detection transformer box	2	10 m or less																
Wiring between the phase detection transformer box and the inverter	0.75 to 1.25	5 m or less																

● Control terminal option

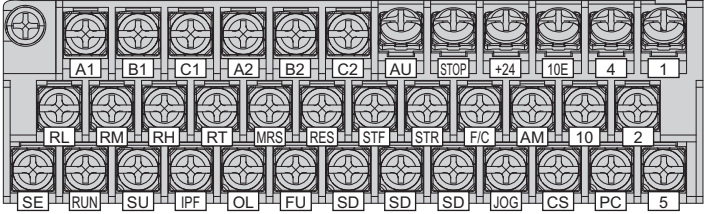
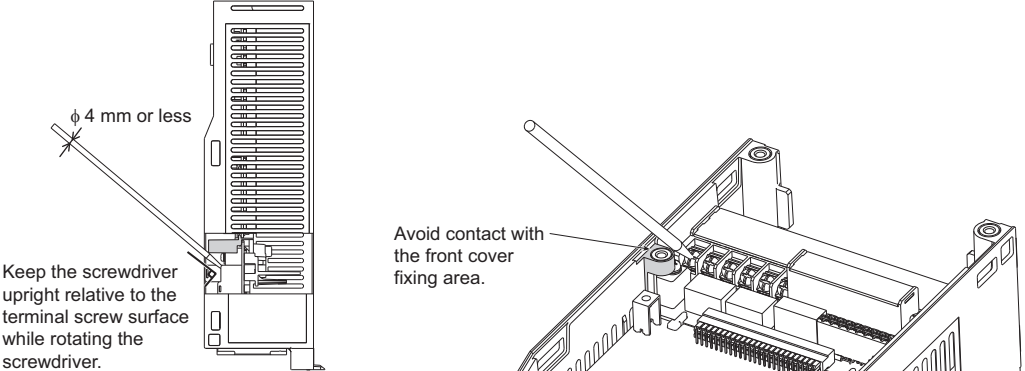
Name (model)	Specification and structure
<p data-bbox="172 712 363 757">Screw terminal block FR-A8TR</p> 	<p data-bbox="387 297 1225 320">Replace the standard control circuit terminal block with this option. (Not available for the FR-F800-E.)</p> <ul data-bbox="387 320 531 342" style="list-style-type: none"> Terminal layout <div data-bbox="579 353 930 439" style="border: 1px solid black; padding: 5px; width: fit-content; margin: 10px auto;"> <p>Terminal screw size : M3.5 Tightening torque : 1.2 N·m Recommended cable gauge : 0.75 mm²</p> </div>  <ul data-bbox="387 701 1473 896" style="list-style-type: none"> Restrictions for the FR-A8TR As compared with the standard control circuit terminal block, the FR-A8TR has the following restrictions. <ol style="list-style-type: none"> When the plug-in option FR-A8NC or FR-A8NCE is used, terminals +24, 10E, 4, and STOP of the FR-A8TR cannot be used. Because the height is restricted, two wires cannot be wired to upper-row terminals (except for terminals A1, B1, C1, A2, B2, and C2) and middle-row terminals on the terminal block. The safety stop function is not available. For the connection to the terminal 1, use a screwdriver with a diameter of 4 mm or less. To avoid contact with the front cover fixing area, put the screwdriver upright relative to the terminal screw surface. <div data-bbox="411 907 1441 1276">  <p>Keep the screwdriver upright relative to the terminal screw surface while rotating the screwdriver.</p> <p>Avoid contact with the front cover fixing area.</p> </div>

● Stand-alone option

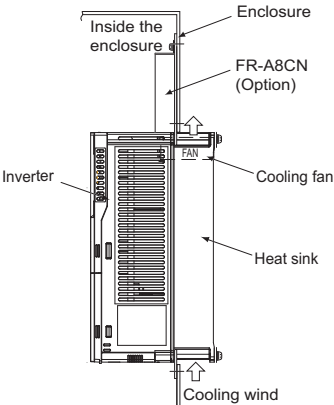
Name (model)	Specification and structure																																
<p data-bbox="204 1697 331 1765">Panel through attachment FR-A8CN□</p>	<p data-bbox="387 1433 1473 1518">With this attachment the heat sink which is the exothermic section of the inverter can be placed on the rear of the enclosure. Since the heat generated in the inverter can be radiated to the rear of the enclosure, the enclosure can be downsized. The use of this attachment requires more installation area. For installation, refer to the drawing after attachment installation (page 36).</p> <p data-bbox="387 1523 810 1545">For the enclosure cut dimensions, refer to page 36.</p> <ul data-bbox="387 1550 547 1572" style="list-style-type: none"> Applicable model <table border="1" data-bbox="387 1579 1069 1989"> <thead> <tr> <th rowspan="2">Model</th> <th colspan="2">Applicable inverter</th> </tr> <tr> <th>FR-F820</th> <th>FR-F840</th> </tr> </thead> <tbody> <tr> <td>FR-A8CN01</td> <td>00105(2.2K), 00167(3.7K), 00250(5.5K)</td> <td>00023(0.75K), 00038(1.5K), 00052(2.2K), 00083(3.7K), 00126(5.5K)</td> </tr> <tr> <td>FR-A8CN02</td> <td>00340(7.5K), 00490(11K)</td> <td>00170(7.5K), 00250(11K)</td> </tr> <tr> <td>FR-A8CN03</td> <td>00630(15K)</td> <td>00310(15K), 00380(18.5K)</td> </tr> <tr> <td>FR-A8CN04</td> <td>00770(18.5K), 00930(22K), 01250(30K)</td> <td>00470(22K), 00620(30K)</td> </tr> <tr> <td>FR-A8CN05</td> <td>01540(37K)</td> <td>00770(37K)</td> </tr> <tr> <td>FR-A8CN06</td> <td>01870(45K), 02330(55K)</td> <td>00930(45K), 01160(55K), 01800(75K)</td> </tr> <tr> <td>FR-A8CN07</td> <td>03160(75K)</td> <td>—</td> </tr> <tr> <td>FR-A8CN08</td> <td>03800(90K), 04750(110K)</td> <td>03250(132K), 03610(160K)</td> </tr> <tr> <td>FR-A8CN09</td> <td>—</td> <td>02160(90K), 02600(110K)</td> </tr> </tbody> </table> 	Model	Applicable inverter		FR-F820	FR-F840	FR-A8CN01	00105(2.2K), 00167(3.7K), 00250(5.5K)	00023(0.75K), 00038(1.5K), 00052(2.2K), 00083(3.7K), 00126(5.5K)	FR-A8CN02	00340(7.5K), 00490(11K)	00170(7.5K), 00250(11K)	FR-A8CN03	00630(15K)	00310(15K), 00380(18.5K)	FR-A8CN04	00770(18.5K), 00930(22K), 01250(30K)	00470(22K), 00620(30K)	FR-A8CN05	01540(37K)	00770(37K)	FR-A8CN06	01870(45K), 02330(55K)	00930(45K), 01160(55K), 01800(75K)	FR-A8CN07	03160(75K)	—	FR-A8CN08	03800(90K), 04750(110K)	03250(132K), 03610(160K)	FR-A8CN09	—	02160(90K), 02600(110K)
Model	Applicable inverter																																
	FR-F820	FR-F840																															
FR-A8CN01	00105(2.2K), 00167(3.7K), 00250(5.5K)	00023(0.75K), 00038(1.5K), 00052(2.2K), 00083(3.7K), 00126(5.5K)																															
FR-A8CN02	00340(7.5K), 00490(11K)	00170(7.5K), 00250(11K)																															
FR-A8CN03	00630(15K)	00310(15K), 00380(18.5K)																															
FR-A8CN04	00770(18.5K), 00930(22K), 01250(30K)	00470(22K), 00620(30K)																															
FR-A8CN05	01540(37K)	00770(37K)																															
FR-A8CN06	01870(45K), 02330(55K)	00930(45K), 01160(55K), 01800(75K)																															
FR-A8CN07	03160(75K)	—																															
FR-A8CN08	03800(90K), 04750(110K)	03250(132K), 03610(160K)																															
FR-A8CN09	—	02160(90K), 02600(110K)																															

Name (model)	Specification and structure									
Intercompatibility attachment FR-AAT□ FR-A5AT□ FR-F8AT□	Enables FR-F800 to be attached using the mounting holes made for the conventional FR-F700(P)/F500/A100E series inverter. This attachment is useful when replacing a conventional inverter with FR-F800.									
	[FR-AAT, FR-A5AT] The inverter with this attachment requires greater installation depth.									
	• Models replaceable with FR-F820									
			FR-F820							
			00046(0.75K)/00077(1.5K)	00105(2.2K) to 00250(5.5K)	00340(7.5K)/00490(11K)	00630(15K)	00770(18.5K) to 01250(30K)	01540(37K)	01870(45K)/02330(55K)	
	Conventional model and capacity	FR-A120E	0.75K	FR-A5AT01	—	—	—	—	—	
			1.5K to 3.7K	FR-A5AT02	FR-A5AT02	—	—	—	—	
			5.5K to 11K	—	FR-A5AT03	FR-A5AT03	—	—	—	
			15K/18.5K	—	—	FR-AAT02	FR-AAT24	○	—	
			22K/30K	—	—	—	FR-A5AT04	FR-A5AT04	—	
			37K	—	—	—	—	FR-AAT27	○	
			45K	—	—	—	—	—	FR-AAT23	
		55K	—	—	—	—	—	—	FR-A5AT05	
		FR-F520	0.75K	○	—	—	—	—	—	—
			1.5K to 3.7K	FR-AAT21	○	—	—	—	—	—
			5.5K/7.5K	—	FR-AAT22	○	—	—	—	—
			11K	—	FR-A5AT03	FR-A5AT03	—	—	—	—
			15K to 22K	—	—	FR-AAT02	FR-AAT24	○	—	—
			30K	—	—	—	FR-A5AT04	FR-A5AT04	—	—
	37K		—	—	—	—	FR-AAT27	○	—	
	45K	—	—	—	—	—	FR-AAT23	○		
	55K	—	—	—	—	—	—	FR-A5AT05		
	FR-F720(P)	0.75K/1.5K	○	—	—	—	—	—	—	
		2.2K to 5.5K	FR-AAT21	○	—	—	—	—	—	
7.5K/11K		—	FR-AAT22	○	—	—	—	—		
15K		—	FR-A5AT03	FR-A5AT03	○	—	—	—		
18.5K to 30K		—	—	—	FR-AAT24	○	—	—		
37K	—	—	—	—	FR-AAT27	○	—			
45K/55K	—	—	—	—	—	FR-AAT23	○			
• Models replaceable with FR-F840										
		FR-F840								
		00023(0.75K) to 00126(5.5K)	00170(7.5K)/00250(11K)	00310(15K)/00380(18.5K)	00470(22K)/00620(30K)	00770(37K)	00930(45K)/01160(55K)			
Conventional model and capacity	FR-A140E	0.75K to 3.7K	FR-A5AT02	—	—	—	—	—		
		5.5K to 11K	FR-A5AT03	FR-A5AT03	—	—	—	—		
		15K/18.5K	—	FR-AAT02	FR-AAT24	—	—	—		
		22K	—	—	FR-A5AT04	FR-A5AT04	—	—		
		30K	—	—	—	FR-AAT27	—	—		
		37K/45K	—	—	—	—	FR-AAT23	○		
		55K	—	—	—	—	—	FR-A5AT05		
	FR-F540	0.75K to 3.7K	○	—	—	—	—	—		
		5.5K to 11K	FR-AAT22	○	—	—	—	—		
		15K to 22K	—	FR-AAT02	FR-AAT24	○	—	—		
		30K/37K	—	—	—	FR-AAT27	○	—		
	45K/55K	—	—	—	—	FR-AAT23	○	—		
	FR-F740(P)	0.75K to 5.5K	○	—	—	—	—	—		
		7.5K/11K	—	○	—	—	—	—		
15K/18.5K		FR-A5AT03	FR-A5AT03	○	—	—	—			
22K/30K		—	—	FR-AAT24	○	—	—			
37K		—	—	—	FR-AAT27	○	—			
45K/55K	—	—	—	—	FR-AAT23	○	—			
○: Replaceable without the intercompatibility attachment FR-A5AT□□, FR-AAT□□: Replaceable with the intercompatibility attachment.										
[FR-F8AT] The FR-F8AT01 can be used in replacing FR-F520L-75K and FR-F720-75K with FR-F820-03160(75K).										

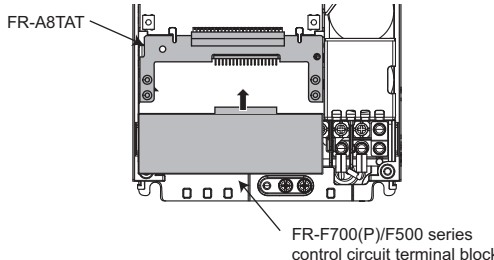
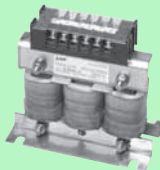
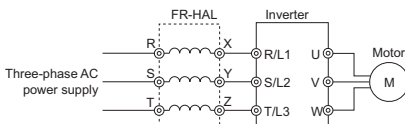
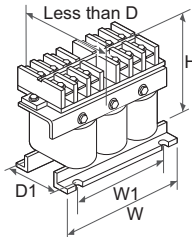
Name (model)	Specification and structure																																																																																																																																																																																																																																																																																																																																
<p>Control circuit terminal block intercompatibility attachment FR-A8TAT</p>	<p>This attachment allows the conventional FR-F700(P)/F500 series control circuit terminal blocks to be installed without removing any cables. This attachment is useful when replacing a conventional inverter with FR-F700P.</p>  <p>(a) For using the control circuit terminal block of the FR-F500 series, open or remove the cover of the control circuit terminal block. Otherwise, the front cover of the inverter may not close properly.</p> <p>(b) Since the specifications of the control circuit terminals of the FR-F700(P)/F500 series are different from those of the FR-F800 series, certain functions of the inverter are restricted (refer to the table below).</p> <table border="1" data-bbox="502 638 1260 750"> <thead> <tr> <th></th> <th>Relay output 2 terminals</th> <th>24 V external power supply input terminal</th> <th>Safety stop signal terminals</th> </tr> </thead> <tbody> <tr> <td>FR-F500 series</td> <td>×</td> <td>×</td> <td>×</td> </tr> <tr> <td>FR-F700(P) series</td> <td>○</td> <td>×</td> <td>×</td> </tr> </tbody> </table> <p>○...Available, ×...Not available</p> <p>(c) The FR-A8NC or FR-A8NCE plug-in option cannot be used.</p> <p>(d) When using a plug-in option, connect the plug-in option using a cable that can be routed through the space between the front cover and the control circuit terminal block (FR-F700(P) series: 7 mm, FR-F500 series: 0.8 mm).</p>		Relay output 2 terminals	24 V external power supply input terminal	Safety stop signal terminals	FR-F500 series	×	×	×	FR-F700(P) series	○	×	×																																																																																																																																																																																																																																																																																																																				
	Relay output 2 terminals	24 V external power supply input terminal	Safety stop signal terminals																																																																																																																																																																																																																																																																																																																														
FR-F500 series	×	×	×																																																																																																																																																																																																																																																																																																																														
FR-F700(P) series	○	×	×																																																																																																																																																																																																																																																																																																																														
<p>AC reactor (for power supply coordination) FR-HAL-(H)[]K</p> 	<p>Improves the power factor and reduces the harmonic current at the input side. Connect an AC reactor at the input side of the inverter.</p> <ul style="list-style-type: none"> • Selection method Select an AC reactor according to the applied motor capacity. (Select the AC reactor according to the motor capacity even if the capacity is smaller than the inverter capacity.) • Connection diagram  <ul style="list-style-type: none"> • Outline dimensions (Unit: mm) <table border="1" data-bbox="399 1142 925 1691"> <thead> <tr> <th>Model</th> <th>W</th> <th>W1</th> <th>H</th> <th>D</th> <th>D1</th> <th>d</th> <th>Mass (kg)</th> </tr> </thead> <tbody> <tr><td>0.4K</td><td>104</td><td>84</td><td>99</td><td>72</td><td>40</td><td>M5</td><td>0.6</td></tr> <tr><td>0.75K</td><td>104</td><td>84</td><td>99</td><td>74</td><td>44</td><td>M5</td><td>0.8</td></tr> <tr><td>1.5K</td><td>104</td><td>84</td><td>99</td><td>77</td><td>50</td><td>M5</td><td>1.1</td></tr> <tr><td>2.2K</td><td>115</td><td>40</td><td>115</td><td>77</td><td>57</td><td>M6</td><td>1.5</td></tr> <tr><td>3.7K</td><td>115</td><td>40</td><td>115</td><td>83</td><td>67</td><td>M6</td><td>2.2</td></tr> <tr><td>5.5K</td><td>115</td><td>40</td><td>115</td><td>83</td><td>67</td><td>M6</td><td>2.3</td></tr> <tr><td>7.5K</td><td>130</td><td>50</td><td>135</td><td>100</td><td>86</td><td>M6</td><td>4.2</td></tr> <tr><td>11K</td><td>160</td><td>75</td><td>164</td><td>111</td><td>92</td><td>M6</td><td>5.2</td></tr> <tr><td>15K</td><td>160</td><td>75</td><td>167</td><td>126</td><td>107</td><td>M6</td><td>7.0</td></tr> <tr><td>18.5K</td><td>160</td><td>75</td><td>128</td><td>175</td><td>107</td><td>M6</td><td>7.1</td></tr> <tr><td>22K</td><td>185</td><td>75</td><td>150</td><td>158</td><td>87</td><td>M6</td><td>9.0</td></tr> <tr><td>30K</td><td>185</td><td>75</td><td>150</td><td>168</td><td>87</td><td>M6</td><td>9.7</td></tr> <tr><td>37K</td><td>210</td><td>75</td><td>175</td><td>174</td><td>82</td><td>M6</td><td>12.9</td></tr> <tr><td>45K</td><td>210</td><td>75</td><td>175</td><td>191</td><td>97</td><td>M6</td><td>16.4</td></tr> <tr><td>55K</td><td>210</td><td>75</td><td>175</td><td>201</td><td>97</td><td>M6</td><td>17.4</td></tr> <tr><td>75K</td><td>240</td><td>150</td><td>210</td><td>215.5</td><td>109</td><td>M8</td><td>23</td></tr> <tr><td>110K</td><td>330</td><td>170</td><td>325</td><td>259</td><td>127</td><td>M10</td><td>40</td></tr> </tbody> </table> <table border="1" data-bbox="941 1131 1468 1792"> <thead> <tr> <th>Model</th> <th>W</th> <th>W1</th> <th>H</th> <th>D</th> <th>D1</th> <th>d</th> <th>Mass (kg)</th> </tr> </thead> <tbody> <tr><td>H0.4K</td><td>135</td><td>120</td><td>115</td><td>64</td><td>45</td><td>M4</td><td>1.5</td></tr> <tr><td>H0.75K</td><td>135</td><td>120</td><td>115</td><td>64</td><td>45</td><td>M4</td><td>1.5</td></tr> <tr><td>H1.5K</td><td>135</td><td>120</td><td>115</td><td>64</td><td>45</td><td>M4</td><td>1.5</td></tr> <tr><td>H2.2K</td><td>135</td><td>120</td><td>115</td><td>64</td><td>45</td><td>M4</td><td>1.5</td></tr> <tr><td>H3.7K</td><td>135</td><td>120</td><td>115</td><td>74</td><td>57</td><td>M4</td><td>2.5</td></tr> <tr><td>H5.5K</td><td>160</td><td>145</td><td>150</td><td>76</td><td>55</td><td>M4</td><td>3.5</td></tr> <tr><td>H7.5K</td><td>160</td><td>145</td><td>150</td><td>96</td><td>75</td><td>M4</td><td>5.0</td></tr> <tr><td>H11K</td><td>160</td><td>145</td><td>146</td><td>96</td><td>75</td><td>M4</td><td>6.0</td></tr> <tr><td>H15K</td><td>220</td><td>200</td><td>195</td><td>105</td><td>70</td><td>M5</td><td>9.0</td></tr> <tr><td>H18.5K</td><td>220</td><td>200</td><td>212</td><td>155</td><td>70</td><td>M5</td><td>9.0</td></tr> <tr><td>H22K</td><td>220</td><td>200</td><td>212</td><td>155</td><td>70</td><td>M5</td><td>9.5</td></tr> <tr><td>H30K</td><td>220</td><td>200</td><td>212</td><td>153</td><td>75</td><td>M5</td><td>11</td></tr> <tr><td>H37K</td><td>220</td><td>200</td><td>211</td><td>160</td><td>100</td><td>M5</td><td>12.5</td></tr> <tr><td>H45K</td><td>280</td><td>255</td><td>242</td><td>165</td><td>80</td><td>M6</td><td>15</td></tr> <tr><td>H55K</td><td>280</td><td>255</td><td>242</td><td>170</td><td>90</td><td>M6</td><td>18</td></tr> <tr><td>H75K</td><td>210</td><td>75</td><td>170</td><td>210.5</td><td>105</td><td>M6</td><td>20</td></tr> <tr><td>H110K</td><td>240</td><td>150</td><td>225</td><td>220</td><td>99</td><td>M8</td><td>28</td></tr> <tr><td>H185K</td><td>330</td><td>170</td><td>325</td><td>271</td><td>142</td><td>M10</td><td>55</td></tr> <tr><td>H280K</td><td>330</td><td>170</td><td>325</td><td>321</td><td>192</td><td>M10</td><td>80</td></tr> <tr><td>H355K</td><td>330</td><td>170</td><td>325</td><td>346</td><td>192</td><td>M10</td><td>90</td></tr> <tr><td>H560K</td><td>450</td><td>300</td><td>540</td><td>635</td><td>345</td><td>M12</td><td>190</td></tr> </tbody> </table> <p>(a) Approximately 88% of the power factor improving effect can be obtained (92.3% when calculated with 1 power factor for the fundamental wave according to the Architectural Standard Specifications (Electrical Installation) supervised by the Ministry of Land, Infrastructure, Transport and Tourism of Japan)</p> <p>(b) This is a sample outline dimension drawing. The shape differs by the model. W1 and D1 indicate distances between installation holes. The installation hole size is indicated by d.</p> <p>(c) When installing an AC reactor (FR-HAL), install in the orientation shown below. •(H)55K or lower: Horizontal installation or vertical installation •(H)75K or higher: Horizontal installation</p> <p>(d) Keep enough clearance around the reactor because it heats up. (Keep a clearance of minimum 10cm each on top and bottom and minimum 5cm each on right and left regardless of the installation orientation.)</p> 	Model	W	W1	H	D	D1	d	Mass (kg)	0.4K	104	84	99	72	40	M5	0.6	0.75K	104	84	99	74	44	M5	0.8	1.5K	104	84	99	77	50	M5	1.1	2.2K	115	40	115	77	57	M6	1.5	3.7K	115	40	115	83	67	M6	2.2	5.5K	115	40	115	83	67	M6	2.3	7.5K	130	50	135	100	86	M6	4.2	11K	160	75	164	111	92	M6	5.2	15K	160	75	167	126	107	M6	7.0	18.5K	160	75	128	175	107	M6	7.1	22K	185	75	150	158	87	M6	9.0	30K	185	75	150	168	87	M6	9.7	37K	210	75	175	174	82	M6	12.9	45K	210	75	175	191	97	M6	16.4	55K	210	75	175	201	97	M6	17.4	75K	240	150	210	215.5	109	M8	23	110K	330	170	325	259	127	M10	40	Model	W	W1	H	D	D1	d	Mass (kg)	H0.4K	135	120	115	64	45	M4	1.5	H0.75K	135	120	115	64	45	M4	1.5	H1.5K	135	120	115	64	45	M4	1.5	H2.2K	135	120	115	64	45	M4	1.5	H3.7K	135	120	115	74	57	M4	2.5	H5.5K	160	145	150	76	55	M4	3.5	H7.5K	160	145	150	96	75	M4	5.0	H11K	160	145	146	96	75	M4	6.0	H15K	220	200	195	105	70	M5	9.0	H18.5K	220	200	212	155	70	M5	9.0	H22K	220	200	212	155	70	M5	9.5	H30K	220	200	212	153	75	M5	11	H37K	220	200	211	160	100	M5	12.5	H45K	280	255	242	165	80	M6	15	H55K	280	255	242	170	90	M6	18	H75K	210	75	170	210.5	105	M6	20	H110K	240	150	225	220	99	M8	28	H185K	330	170	325	271	142	M10	55	H280K	330	170	325	321	192	M10	80	H355K	330	170	325	346	192	M10	90	H560K	450	300	540	635	345	M12	190
Model	W	W1	H	D	D1	d	Mass (kg)																																																																																																																																																																																																																																																																																																																										
0.4K	104	84	99	72	40	M5	0.6																																																																																																																																																																																																																																																																																																																										
0.75K	104	84	99	74	44	M5	0.8																																																																																																																																																																																																																																																																																																																										
1.5K	104	84	99	77	50	M5	1.1																																																																																																																																																																																																																																																																																																																										
2.2K	115	40	115	77	57	M6	1.5																																																																																																																																																																																																																																																																																																																										
3.7K	115	40	115	83	67	M6	2.2																																																																																																																																																																																																																																																																																																																										
5.5K	115	40	115	83	67	M6	2.3																																																																																																																																																																																																																																																																																																																										
7.5K	130	50	135	100	86	M6	4.2																																																																																																																																																																																																																																																																																																																										
11K	160	75	164	111	92	M6	5.2																																																																																																																																																																																																																																																																																																																										
15K	160	75	167	126	107	M6	7.0																																																																																																																																																																																																																																																																																																																										
18.5K	160	75	128	175	107	M6	7.1																																																																																																																																																																																																																																																																																																																										
22K	185	75	150	158	87	M6	9.0																																																																																																																																																																																																																																																																																																																										
30K	185	75	150	168	87	M6	9.7																																																																																																																																																																																																																																																																																																																										
37K	210	75	175	174	82	M6	12.9																																																																																																																																																																																																																																																																																																																										
45K	210	75	175	191	97	M6	16.4																																																																																																																																																																																																																																																																																																																										
55K	210	75	175	201	97	M6	17.4																																																																																																																																																																																																																																																																																																																										
75K	240	150	210	215.5	109	M8	23																																																																																																																																																																																																																																																																																																																										
110K	330	170	325	259	127	M10	40																																																																																																																																																																																																																																																																																																																										
Model	W	W1	H	D	D1	d	Mass (kg)																																																																																																																																																																																																																																																																																																																										
H0.4K	135	120	115	64	45	M4	1.5																																																																																																																																																																																																																																																																																																																										
H0.75K	135	120	115	64	45	M4	1.5																																																																																																																																																																																																																																																																																																																										
H1.5K	135	120	115	64	45	M4	1.5																																																																																																																																																																																																																																																																																																																										
H2.2K	135	120	115	64	45	M4	1.5																																																																																																																																																																																																																																																																																																																										
H3.7K	135	120	115	74	57	M4	2.5																																																																																																																																																																																																																																																																																																																										
H5.5K	160	145	150	76	55	M4	3.5																																																																																																																																																																																																																																																																																																																										
H7.5K	160	145	150	96	75	M4	5.0																																																																																																																																																																																																																																																																																																																										
H11K	160	145	146	96	75	M4	6.0																																																																																																																																																																																																																																																																																																																										
H15K	220	200	195	105	70	M5	9.0																																																																																																																																																																																																																																																																																																																										
H18.5K	220	200	212	155	70	M5	9.0																																																																																																																																																																																																																																																																																																																										
H22K	220	200	212	155	70	M5	9.5																																																																																																																																																																																																																																																																																																																										
H30K	220	200	212	153	75	M5	11																																																																																																																																																																																																																																																																																																																										
H37K	220	200	211	160	100	M5	12.5																																																																																																																																																																																																																																																																																																																										
H45K	280	255	242	165	80	M6	15																																																																																																																																																																																																																																																																																																																										
H55K	280	255	242	170	90	M6	18																																																																																																																																																																																																																																																																																																																										
H75K	210	75	170	210.5	105	M6	20																																																																																																																																																																																																																																																																																																																										
H110K	240	150	225	220	99	M8	28																																																																																																																																																																																																																																																																																																																										
H185K	330	170	325	271	142	M10	55																																																																																																																																																																																																																																																																																																																										
H280K	330	170	325	321	192	M10	80																																																																																																																																																																																																																																																																																																																										
H355K	330	170	325	346	192	M10	90																																																																																																																																																																																																																																																																																																																										
H560K	450	300	540	635	345	M12	190																																																																																																																																																																																																																																																																																																																										

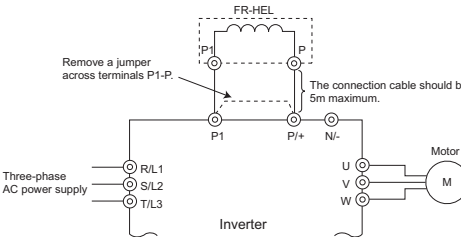
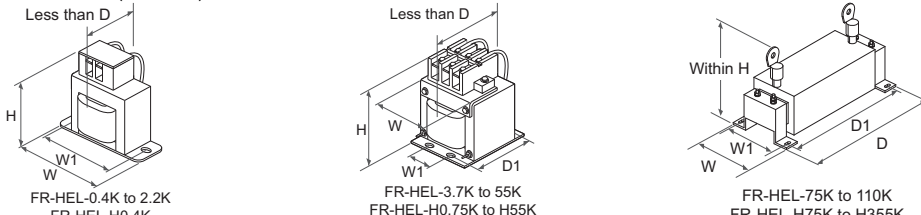
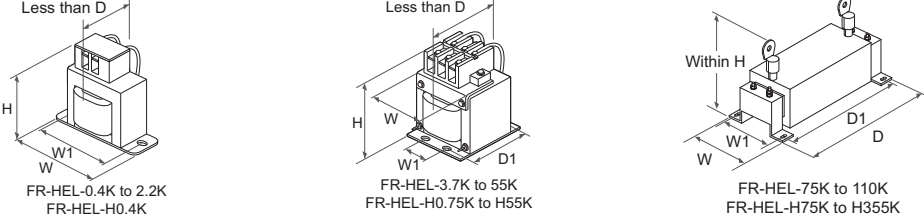
Name (model)	Specification and structure																																																																																																																																																																																																																																																																																																																																																																																
<p data-bbox="148 965 308 1043">DC reactor (for power supply coordination) FR-HEL-(H)□K</p> 	<p data-bbox="347 226 1257 264">Improves the power factor and reduces the harmonic current at the input side. Make sure to install this option for the FR-F820-03160(75K) or higher and the FR-F840-01800(75K) or higher.</p> <ul data-bbox="347 271 1437 566" style="list-style-type: none"> • Selection method Select a DC reactor according to the applied motor capacity. (Select it according to the motor capacity even if the capacity is smaller than the inverter capacity.) (Refer to page 124.) • Connection diagram Connect a DC reactor to the inverter terminals P1 and P. Remove the jumper across terminals P1 and P. If the jumper is left attached, no power factor improvement can be obtained. (The jumper is not installed for the FR-F820-03160(75K) or higher and the FR-F840-01800(75K) or higher.) The connection cable between the reactor and the inverter should be as short as possible (5m or less). • Outline dimension (Unit: mm)  																																																																																																																																																																																																																																																																																																																																																																																
	<table border="1" data-bbox="368 864 879 1429"> <thead> <tr> <th>Model</th> <th>W</th> <th>W1</th> <th>H</th> <th>D</th> <th>D1</th> <th>d</th> <th>Mass (kg)</th> </tr> </thead> <tbody> <tr><td>0.4K</td><td>70</td><td>60</td><td>71</td><td>61</td><td>-</td><td>M4</td><td>0.34</td></tr> <tr><td>0.75K</td><td>85</td><td>74</td><td>81</td><td>61</td><td>-</td><td>M4</td><td>0.5</td></tr> <tr><td>1.5K</td><td>85</td><td>74</td><td>81</td><td>70</td><td>-</td><td>M4</td><td>0.7</td></tr> <tr><td>2.2K</td><td>85</td><td>74</td><td>81</td><td>70</td><td>-</td><td>M4</td><td>0.8</td></tr> <tr><td>3.7K</td><td>77</td><td>55</td><td>92</td><td>82</td><td>56</td><td>M4</td><td>1.4</td></tr> <tr><td>5.5K</td><td>77</td><td>55</td><td>92</td><td>92</td><td>66</td><td>M4</td><td>1.7</td></tr> <tr><td>7.5K</td><td>86</td><td>60</td><td>122</td><td>98</td><td>73</td><td>M4</td><td>2.3</td></tr> <tr><td>11K</td><td>105</td><td>64</td><td>138</td><td>112</td><td>78</td><td>M6</td><td>3.1</td></tr> <tr><td>15K</td><td>105</td><td>64</td><td>142</td><td>115</td><td>83</td><td>M6</td><td>3.8</td></tr> <tr><td>18.5K</td><td>105</td><td>64</td><td>93</td><td>165</td><td>93</td><td>M6</td><td>4.1</td></tr> <tr><td>22K</td><td>105</td><td>64</td><td>93</td><td>175</td><td>103</td><td>M6</td><td>4.8</td></tr> <tr><td>30K</td><td>114</td><td>72</td><td>100</td><td>200</td><td>100</td><td>M6</td><td>6.7</td></tr> <tr><td>37K</td><td>133</td><td>86</td><td>117</td><td>195</td><td>97</td><td>M6</td><td>8.1</td></tr> <tr><td>45K</td><td>133</td><td>86</td><td>117</td><td>205</td><td>107</td><td>M6</td><td>9.4</td></tr> <tr><td>55K</td><td>153</td><td>126</td><td>132</td><td>209</td><td>121</td><td>M6</td><td>11.0</td></tr> <tr><td>75K</td><td>150</td><td>130</td><td>190</td><td>340</td><td>310</td><td>M6</td><td>17</td></tr> <tr><td>90K</td><td>150</td><td>130</td><td>200</td><td>340</td><td>310</td><td>M6</td><td>19</td></tr> <tr><td>110K</td><td>175</td><td>150</td><td>200</td><td>400</td><td>365</td><td>M8</td><td>20</td></tr> </tbody> </table>	Model	W	W1	H	D	D1	d	Mass (kg)	0.4K	70	60	71	61	-	M4	0.34	0.75K	85	74	81	61	-	M4	0.5	1.5K	85	74	81	70	-	M4	0.7	2.2K	85	74	81	70	-	M4	0.8	3.7K	77	55	92	82	56	M4	1.4	5.5K	77	55	92	92	66	M4	1.7	7.5K	86	60	122	98	73	M4	2.3	11K	105	64	138	112	78	M6	3.1	15K	105	64	142	115	83	M6	3.8	18.5K	105	64	93	165	93	M6	4.1	22K	105	64	93	175	103	M6	4.8	30K	114	72	100	200	100	M6	6.7	37K	133	86	117	195	97	M6	8.1	45K	133	86	117	205	107	M6	9.4	55K	153	126	132	209	121	M6	11.0	75K	150	130	190	340	310	M6	17	90K	150	130	200	340	310	M6	19	110K	175	150	200	400	365	M8	20	<table border="1" data-bbox="911 864 1422 1653"> <thead> <tr> <th>Model</th> <th>W</th> <th>W1</th> <th>H</th> <th>D</th> <th>D1</th> <th>d</th> <th>Mass (kg)</th> </tr> </thead> <tbody> <tr><td>H0.4K</td><td>90</td><td>75</td><td>77</td><td>60</td><td>-</td><td>M5</td><td>0.6</td></tr> <tr><td>H0.75K</td><td>66</td><td>50</td><td>100</td><td>70</td><td>48</td><td>M4</td><td>0.85</td></tr> <tr><td>H1.5K</td><td>66</td><td>50</td><td>100</td><td>80</td><td>54</td><td>M4</td><td>1</td></tr> <tr><td>H2.2K</td><td>76</td><td>50</td><td>110</td><td>80</td><td>54</td><td>M4</td><td>1.3</td></tr> <tr><td>H3.7K</td><td>86</td><td>55</td><td>128</td><td>95</td><td>69</td><td>M4</td><td>2.3</td></tr> <tr><td>H5.5K</td><td>96</td><td>60</td><td>136</td><td>100</td><td>75</td><td>M5</td><td>3</td></tr> <tr><td>H7.5K</td><td>96</td><td>60</td><td>136</td><td>105</td><td>80</td><td>M5</td><td>3.5</td></tr> <tr><td>H11K</td><td>105</td><td>75</td><td>137</td><td>110</td><td>85</td><td>M5</td><td>4.5</td></tr> <tr><td>H15K</td><td>105</td><td>75</td><td>152</td><td>125</td><td>95</td><td>M5</td><td>5</td></tr> <tr><td>H18.5K</td><td>114</td><td>75</td><td>162</td><td>120</td><td>80</td><td>M5</td><td>5</td></tr> <tr><td>H22K</td><td>133</td><td>90</td><td>180</td><td>120</td><td>75</td><td>M5</td><td>6</td></tr> <tr><td>H30K</td><td>133</td><td>90</td><td>180</td><td>120</td><td>80</td><td>M5</td><td>6.5</td></tr> <tr><td>H37K</td><td>133</td><td>90</td><td>184</td><td>155</td><td>100</td><td>M5</td><td>8.5</td></tr> <tr><td>H45K</td><td>133</td><td>90</td><td>184</td><td>170</td><td>110</td><td>M5</td><td>10</td></tr> <tr><td>H55K</td><td>152</td><td>105</td><td>203</td><td>170</td><td>106</td><td>M6</td><td>11.5</td></tr> <tr><td>H75K</td><td>140</td><td>120</td><td>185</td><td>320</td><td>295</td><td>M6</td><td>16</td></tr> <tr><td>H90K</td><td>150</td><td>130</td><td>190</td><td>340</td><td>310</td><td>M6</td><td>20</td></tr> <tr><td>H110K</td><td>150</td><td>130</td><td>195</td><td>340</td><td>310</td><td>M6</td><td>22</td></tr> <tr><td>H132K</td><td>175</td><td>150</td><td>200</td><td>405</td><td>370</td><td>M8</td><td>26</td></tr> <tr><td>H160K</td><td>175</td><td>150</td><td>205</td><td>405</td><td>370</td><td>M8</td><td>28</td></tr> <tr><td>H185K</td><td>175</td><td>150</td><td>240</td><td>405</td><td>370</td><td>M8</td><td>29</td></tr> <tr><td>H220K</td><td>175</td><td>150</td><td>240</td><td>405</td><td>370</td><td>M8</td><td>30</td></tr> <tr><td>H250K</td><td>190</td><td>165</td><td>250</td><td>440</td><td>400</td><td>M8</td><td>35</td></tr> <tr><td>H280K</td><td>190</td><td>165</td><td>255</td><td>440</td><td>400</td><td>M8</td><td>38</td></tr> <tr><td>H315K</td><td>210</td><td>185</td><td>250</td><td>495</td><td>450</td><td>M10</td><td>42</td></tr> <tr><td>H355K</td><td>210</td><td>185</td><td>250</td><td>495</td><td>450</td><td>M10</td><td>46</td></tr> </tbody> </table>	Model	W	W1	H	D	D1	d	Mass (kg)	H0.4K	90	75	77	60	-	M5	0.6	H0.75K	66	50	100	70	48	M4	0.85	H1.5K	66	50	100	80	54	M4	1	H2.2K	76	50	110	80	54	M4	1.3	H3.7K	86	55	128	95	69	M4	2.3	H5.5K	96	60	136	100	75	M5	3	H7.5K	96	60	136	105	80	M5	3.5	H11K	105	75	137	110	85	M5	4.5	H15K	105	75	152	125	95	M5	5	H18.5K	114	75	162	120	80	M5	5	H22K	133	90	180	120	75	M5	6	H30K	133	90	180	120	80	M5	6.5	H37K	133	90	184	155	100	M5	8.5	H45K	133	90	184	170	110	M5	10	H55K	152	105	203	170	106	M6	11.5	H75K	140	120	185	320	295	M6	16	H90K	150	130	190	340	310	M6	20	H110K	150	130	195	340	310	M6	22	H132K	175	150	200	405	370	M8	26	H160K	175	150	205	405	370	M8	28	H185K	175	150	240	405	370	M8	29	H220K	175	150	240	405	370	M8	30	H250K	190	165	250	440	400	M8	35	H280K	190	165	255	440	400	M8	38	H315K	210	185	250	495	450	M10	42	H355K	210	185	250	495	450	M10
Model	W	W1	H	D	D1	d	Mass (kg)																																																																																																																																																																																																																																																																																																																																																																										
0.4K	70	60	71	61	-	M4	0.34																																																																																																																																																																																																																																																																																																																																																																										
0.75K	85	74	81	61	-	M4	0.5																																																																																																																																																																																																																																																																																																																																																																										
1.5K	85	74	81	70	-	M4	0.7																																																																																																																																																																																																																																																																																																																																																																										
2.2K	85	74	81	70	-	M4	0.8																																																																																																																																																																																																																																																																																																																																																																										
3.7K	77	55	92	82	56	M4	1.4																																																																																																																																																																																																																																																																																																																																																																										
5.5K	77	55	92	92	66	M4	1.7																																																																																																																																																																																																																																																																																																																																																																										
7.5K	86	60	122	98	73	M4	2.3																																																																																																																																																																																																																																																																																																																																																																										
11K	105	64	138	112	78	M6	3.1																																																																																																																																																																																																																																																																																																																																																																										
15K	105	64	142	115	83	M6	3.8																																																																																																																																																																																																																																																																																																																																																																										
18.5K	105	64	93	165	93	M6	4.1																																																																																																																																																																																																																																																																																																																																																																										
22K	105	64	93	175	103	M6	4.8																																																																																																																																																																																																																																																																																																																																																																										
30K	114	72	100	200	100	M6	6.7																																																																																																																																																																																																																																																																																																																																																																										
37K	133	86	117	195	97	M6	8.1																																																																																																																																																																																																																																																																																																																																																																										
45K	133	86	117	205	107	M6	9.4																																																																																																																																																																																																																																																																																																																																																																										
55K	153	126	132	209	121	M6	11.0																																																																																																																																																																																																																																																																																																																																																																										
75K	150	130	190	340	310	M6	17																																																																																																																																																																																																																																																																																																																																																																										
90K	150	130	200	340	310	M6	19																																																																																																																																																																																																																																																																																																																																																																										
110K	175	150	200	400	365	M8	20																																																																																																																																																																																																																																																																																																																																																																										
Model	W	W1	H	D	D1	d	Mass (kg)																																																																																																																																																																																																																																																																																																																																																																										
H0.4K	90	75	77	60	-	M5	0.6																																																																																																																																																																																																																																																																																																																																																																										
H0.75K	66	50	100	70	48	M4	0.85																																																																																																																																																																																																																																																																																																																																																																										
H1.5K	66	50	100	80	54	M4	1																																																																																																																																																																																																																																																																																																																																																																										
H2.2K	76	50	110	80	54	M4	1.3																																																																																																																																																																																																																																																																																																																																																																										
H3.7K	86	55	128	95	69	M4	2.3																																																																																																																																																																																																																																																																																																																																																																										
H5.5K	96	60	136	100	75	M5	3																																																																																																																																																																																																																																																																																																																																																																										
H7.5K	96	60	136	105	80	M5	3.5																																																																																																																																																																																																																																																																																																																																																																										
H11K	105	75	137	110	85	M5	4.5																																																																																																																																																																																																																																																																																																																																																																										
H15K	105	75	152	125	95	M5	5																																																																																																																																																																																																																																																																																																																																																																										
H18.5K	114	75	162	120	80	M5	5																																																																																																																																																																																																																																																																																																																																																																										
H22K	133	90	180	120	75	M5	6																																																																																																																																																																																																																																																																																																																																																																										
H30K	133	90	180	120	80	M5	6.5																																																																																																																																																																																																																																																																																																																																																																										
H37K	133	90	184	155	100	M5	8.5																																																																																																																																																																																																																																																																																																																																																																										
H45K	133	90	184	170	110	M5	10																																																																																																																																																																																																																																																																																																																																																																										
H55K	152	105	203	170	106	M6	11.5																																																																																																																																																																																																																																																																																																																																																																										
H75K	140	120	185	320	295	M6	16																																																																																																																																																																																																																																																																																																																																																																										
H90K	150	130	190	340	310	M6	20																																																																																																																																																																																																																																																																																																																																																																										
H110K	150	130	195	340	310	M6	22																																																																																																																																																																																																																																																																																																																																																																										
H132K	175	150	200	405	370	M8	26																																																																																																																																																																																																																																																																																																																																																																										
H160K	175	150	205	405	370	M8	28																																																																																																																																																																																																																																																																																																																																																																										
H185K	175	150	240	405	370	M8	29																																																																																																																																																																																																																																																																																																																																																																										
H220K	175	150	240	405	370	M8	30																																																																																																																																																																																																																																																																																																																																																																										
H250K	190	165	250	440	400	M8	35																																																																																																																																																																																																																																																																																																																																																																										
H280K	190	165	255	440	400	M8	38																																																																																																																																																																																																																																																																																																																																																																										
H315K	210	185	250	495	450	M10	42																																																																																																																																																																																																																																																																																																																																																																										
H355K	210	185	250	495	450	M10	46																																																																																																																																																																																																																																																																																																																																																																										
<p>(a) The size of the cables used should be equal to or larger than that of the power supply cables (R/L1, S/L2, T/L3). (Refer to page 115.)</p> <p>(b) Approximately 93% of the power factor improving effect can be obtained (94.4% when calculated with 1 power factor for the fundamental wave according to the Architectural Standard Specifications (Electrical Installation) supervised by the Ministry of Land, Infrastructure, Transport and Tourism of Japan)</p> <p>(c) The drawings shown above are sample outline dimension drawings. The shape differs by the model. W1 and D1 indicate distances between installation holes. The installation hole size is indicated by d.</p> <p>(d) When installing a DC reactor (FR-HEL), install in the orientation shown below. •(H)55K or lower: Horizontal installation or vertical installation •(H)75K or higher: Horizontal installation</p> <p>(e) Keep enough clearance around the reactor because it heats up. (Keep a clearance of minimum 10cm each on top and bottom and minimum 5cm each on right and left regardless of the installation orientation.)</p>																																																																																																																																																																																																																																																																																																																																																																																	

Name (model)	Specification and structure
<p data-bbox="172 454 363 533">Line noise filter FR-BSF01 (for small capacities) FR-BLF</p> 	<p data-bbox="384 226 1474 309">Install an EMC filter (ferrite core) to reduce the electromagnetic noise generated from the inverter. Effective in the range from about 0.5 MHz to 5 MHz. range from about 0.5MHz to 5MHz. The FR-F820-02330(55K) or lower and FR-F840-01160(55K) or lower are equipped with built-in common mode chokes.</p> <p data-bbox="384 293 549 315">• Outline dimension</p> <div data-bbox="411 320 1053 651"> <p data-bbox="943 622 1038 645">(Unit: mm)</p> </div> <div data-bbox="448 667 1474 887"> <p data-bbox="448 667 1123 707">(a) Wind each phase for three times (4T) in the same direction. (The greater the number of turns, the more effective result is obtained.) When using several line noise filters to make 4T or more, wind the phases (cables) together. Do not use a different line noise filter for different phases.</p> <p data-bbox="448 707 1123 748">(b) When the cables are too thick to be wound, run each cable (phase) through four or more filters installed in series in one direction.</p> <p data-bbox="448 748 1474 788">(c) The filter can be used in the same way as the output side. When using filters at the output side, do not wind the cable more than 3 times (4T) for each filter because the filter may overheat.</p> <p data-bbox="448 788 1474 828">(d) A thick cable of 38 mm² or more is not applicable to the FR-BSF01. Use FR-BLF for a larger diameter cable.</p> <p data-bbox="448 828 858 869">(e) Do not wind the earthing (grounding) cable.</p> <div data-bbox="1145 678 1474 797"> </div> </div>

Name (model)

Specification and structure

Provides a braking capability greater than that is provided by an external brake resistor. This option can also be connected to the inverters without built-in brake transistors. Three types of discharging resistors are available. Make a selection according to the required braking torque.

• Specification
[Brake unit]

Model: FR-BU2-[]	200 V						400 V						
	1.5K	3.7K	7.5K	15K	30K	55K	H7.5K	H15K	H30K	H55K	H75K	H220K	H280K
Applicable motor capacity	The applicable capacity differs by the braking torque and the operation rate (%ED).												
Connected brake resistor	GRZG type, FR-BR, MT-BR5 (For the combination, refer to the table below.)										MT-BR5 *1		
Multiple (parallel) driving	Max. 10 units (However, the torque is limited by the permissible current of the connected inverter.)												
Approximate mass (kg)	0.9	0.9	0.9	0.9	1.4	2.0	0.9	0.9	1.4	2.0	2.0	13	13

*1 Please contact your sales representative to use a brake resistor other than MT-BR5.

[Resistor unit]

Model: GRZG type *2	200 V				400 V			
	GRZG300W-50Ω (1 unit)	GRZG200-10Ω (3 units)	GRZG300-5Ω (4 units)	GRZG400-2Ω (6 units)	GRZG200-10Ω (3 units)	GRZG300-5Ω (4 units)	GRZG400-2Ω (6 units)	
Number of connectable units	1 unit	3 in series (1 set)	4 in series (1 set)	6 in series (1 set)	6 in series (2 sets)	8 in series (2 sets)	12 in series (2 sets)	
Discharging resistor combined resistance (Ω)	50	30	20	12	60	40	24	
Continuous operation permissible power (W)	100	300	600	1200	600	1200	2400	

*2 The 1 set contains the number of units in the parentheses. For the 400 V class, 2 sets are required.

Model: FR-BR-[]	200 V			400 V			Model: MT-BR5-[]	200 V	400 V
	15K	30K	55K	H15K	H30K	H55K		55K	H75K
Discharging resistor combined resistance (Ω)	8	4	2	32	16	8	Discharging resistor combined resistance (Ω)	2	6.5
Continuous operation permissible power (W)	990	1990	3910	990	1990	3910	Continuous operation permissible power (W)	5500	7500
Approximate mass (kg)	15	30	70	15	30	70	Approximate mass (kg)	70	65

• Combination between the brake unit and the resistor unit

Brake unit model	Discharging resistor model or resistor unit model				
	GRZG type		FR-BR	MT-BR5	
	Model *3	Number of connectable units			
200 V	FR-BU2-1.5K	GZG 300W-50Ω (1 unit)	1 unit	-	-
	FR-BU2-3.7K	GRZG 200-10Ω (3 units)	3 in series (1 set)	-	-
	FR-BU2-7.5K	GRZG 300-5Ω (4 units)	4 in series (1 set)	-	-
	FR-BU2-15K	GRZG 400-2Ω (6 units)	6 in series (1 set)	FR-BR-15K	-
	FR-BU2-30K	-	-	FR-BR-30K	-
FR-BU2-55K	-	-	FR-BR-55K	MT-BR5-55K	
400 V	FR-BU2-H7.5K	GRZG 200-10Ω (3 units)	6 in series (2 sets)	-	-
	FR-BU2-H15K	GRZG 300-5Ω (4 units)	8 in series (2 sets)	FR-BR-H15K	-
	FR-BU2-H30K	GRZG 400-2Ω (6 units)	12 in series (2 sets)	FR-BR-H30K	-
	FR-BU2-H55K	-	-	FR-BR-H55K	-
	FR-BU2-H75K	-	-	-	MT-BR5-H75K
	FR-BU2-H220K	-	-	-	3×MT-BR5-H75K *4
FR-BU2-H280K	-	-	-	4×MT-BR5-H75K *4	

*3 The 1 set contains the number of units in the parentheses. For the 400 V class, 2 sets are required.

*4 The number next to the model name indicates the number of connectable units in parallel.

• Selection method
[GRZG type]

• The maximum temperature rise of the discharging resistors is about 100°C. Use heat-resistant wires to perform wiring, and make sure that they will not come in contact with resistors.

• Do not touch the discharging resistor while the power is ON or for about 10 minutes after the power supply turns OFF. Otherwise you may get an electric shock.

Power supply voltage	Braking torque	Motor capacity								
		0.4	0.75	1.5	2.2	3.7	5.5	7.5	11	15
200 V	50% 30 s	FR-BU2-1.5K		FR-BU2-3.7K		FR-BU2-7.5K		FR-BU2-15K		
	100% 30 s	FR-BU2-1.5K		FR-BU2-3.7K		FR-BU2-7.5K		FR-BU2-15K		2×FR-BU2-15K*5
400 V	50% 30 s	--*6				FR-BU2-H7.5K		FR-BU2-H15K		
	100% 30 s	--*6				FR-BU2-H7.5K		FR-BU2-H15K		FR-BU2-H30K

Power supply voltage	Braking torque	Motor capacity								
		18.5	22	30	37	45	55			
200 V	50% 30 s	2×FR-BU2-15K*5			3×FR-BU2-15K*5		4×FR-BU2-15K*5			
	100% 30 s	3×FR-BU2-15K*5		4×FR-BU2-15K*5		5×FR-BU2-15K*5		6×FR-BU2-15K*5		7×FR-BU2-15K*5
400 V	50% 30 s	FR-BU2-H30K			2×FR-BU2-H30K*5					
	100% 30 s	2×FR-BU2-H30K*5			3×FR-BU2-H30K*5			4×FR-BU2-H30K*5		

*5 The number next to the model name indicates the number of connectable units in parallel.

*6 FR-F840-00038(1.5K) or lower capacity inverters cannot be used with brake units. When using brake units with inverters, use the FR-F840-00052(2.2K) or higher capacity inverters.

Brake unit
FR-BU2-(H)[]K

Discharging resistor
GZG type
GRZG type

Resistor unit
FR-BR-(H)[]K
MT-BR5-(H)[]K



Name (model) **Specification and structure**

[FR-BR]
 The maximum temperature rise of the resistor unit is about 100°C. Therefore, use heat-resistant wires (such as glass wires).
 %ED at short-time rating when braking torque is 100%

Model			Motor capacity										
			5.5 kW	7.5 kW	11 kW	15 kW	18.5 kW	22 kW	30 kW	37 kW	45 kW	55 kW	
200 V	FR-BU2-15K	%ED	80	40	15	10	-	-	-	-	-	-	-
	FR-BU2-30K		-	-	65	30	25	15	10	-	-	-	
	FR-BU2-55K		-	-	-	-	90	60	30	20	15	10	
400 V	FR-BU2-H15K	%ED	80	40	15	10	-	-	-	-	-	-	
	FR-BU2-H30K		-	-	65	30	25	15	10	-	-		
	FR-BU2-H55K		-	-	-	-	90	60	30	20	15	10	

Braking torque (%) at 10%ED in short-time rating of 15 s (%)

Model			Motor capacity									
			5.5 kW	7.5 kW	11 kW	15 kW	18.5 kW	22 kW	30 kW	37 kW	45 kW	55 kW
200 V	FR-BU2-15K	Braking torque (%)	280	200	120	100	80	70	-	-	-	-
	FR-BU2-30K		-	-	260	180	160	130	100	80	70	
	FR-BU2-55K		-	-	-	-	300	250	180	150	120	100
400 V	FR-BU2-H15K	Braking torque (%)	280	200	120	100	80	70	-	-	-	-
	FR-BU2-H30K		-	-	260	180	160	130	100	80	70	
	FR-BU2-H55K		-	-	-	-	300	250	180	150	120	100

Regeneration duty factor (operation frequency)%ED = $\frac{tb}{tc} \times 100$ $tb < 15s$ (continuous operation time)

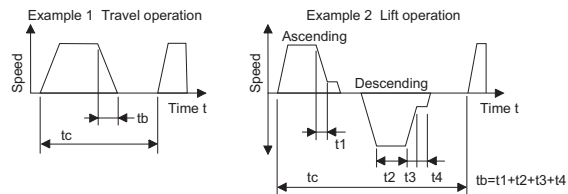

Brake unit
 FR-BU2-(H)□K
Discharging resistor
 GZG type
 GRZG type
Resistor unit
 FR-BR-(H)□K
 MT-BR5-(H)□K



[MT-BR5]

- Be sure to select a well-ventilated place for the installation of the resistor unit. Ventilation is necessary when installing the resistor in a place such as an enclosure, where heat is not well diffused.
 - The maximum temperature rise of the resistor unit is about 300deg. When wiring, be careful not to touch the resistor. Also, keep any heat-sensitive component away from the resistor (minimum 40 to 50cm).
 - The temperature of the resistor unit abnormally increases if the brake unit is operated exceeding the specified duty. Since the resistor unit may result in overheat if the temperature of the brake unit is left unchanged, switch off the inverter.
 - A resistor unit is equipped with thermostat (NO contact) for overheat protection. If this protective thermostat activates in normal operation, the deceleration time may be too short. Set the inverter's deceleration time longer.
- %ED at short-time rating when braking torque is 100%

Number of connectable units*7		Motor capacity															
		75 kW	90 kW	110 kW	132 kW	160 kW	185 kW	220 kW	250 kW	280 kW	315 kW	355 kW	375 kW	400 kW	450 kW	500 kW	560 kW
200 V	FR-BU2-55K	1	5	-	-	-	-	-	-	-	-	-	-	-	-	-	-
	2	20	15	10	-	-	-	-	-	-	-	-	-	-	-	-	-
400 V	FR-BU2-H75K	1	10	5	-	-	-	-	-	-	-	-	-	-	-	-	-
	2	40	25	20	10	5	5	-	-	-	-	-	-	-	-	-	-
400 V	FR-BU2-H220K	1	80	60	40	25	15	10	10	5	-	-	-	-	-	-	-
	2	-	-	-	-	-	-	20	20	15	15	15	10	10	10	5	-
400 V	FR-BU2-H280K	1	-	80	65	40	30	20	15	10	10	5	-	-	-	-	-
	2	-	-	-	-	-	-	-	-	-	20	20	15	15	15	10	10

Braking torque (%) in short-time rating of 15 s (%)

Number of connectable units*7		Motor capacity															
		75 kW	90 kW	110 kW	132 kW	160 kW	185 kW	220 kW	250 kW	280 kW	315 kW	355 kW	375 kW	400 kW	450 kW	500 kW	560 kW
200 V	FR-BU2-55K	1	70	60	50	-	-	-	-	-	-	-	-	-	-	-	-
	2	150	120	100	-	-	-	-	-	-	-	-	-	-	-	-	-
400 V	FR-BU2-H75K	1	100	80	70	55	45	40	35	30	25	20	20	-	-	-	-
	2	150	150	135	110	90	80	70	60	50	45	40	40	-	-	-	-
400 V	FR-BU2-H220K	1	200	200	150	150	135	115	100	80	55	-	-	-	-	-	-
	2	-	-	-	-	-	-	190	170	150	150	140	120	110	100	90	80
400 V	FR-BU2-H280K	1	-	-	200	200	150	150	150	125	100	70	60	-	-	-	-
	2	-	-	-	-	-	-	-	-	-	180	160	150	150	130	115	100

*7 The number next to the model name indicates the number of connectable units in parallel.
 *8 To obtain a large braking torque, the motor has to have a torque characteristic that meets the braking torque. Check the torque characteristic of the motor.

Name (model)

Specification and structure

• Connection diagram

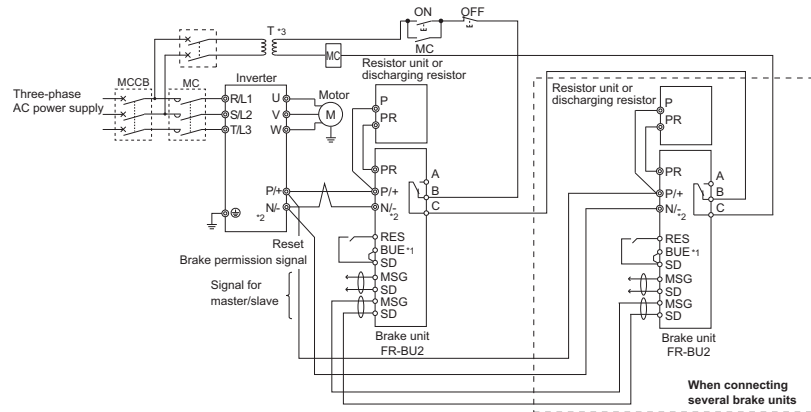

- *1 A jumper is connected across BUE and SD in the initial status.
- *2 When wiring, make sure to match the terminal symbol (P/+, N/-) at the inverter side and at the brake unit (FR-BU2) side. Incorrect connection will damage the inverter. Do not remove the jumper across terminal P/+ and P1 except for connecting the DC reactor.
- *3 When the power supply is 400V class, install a step-down transformer.

• Outline dimensions

<FR-BU2>

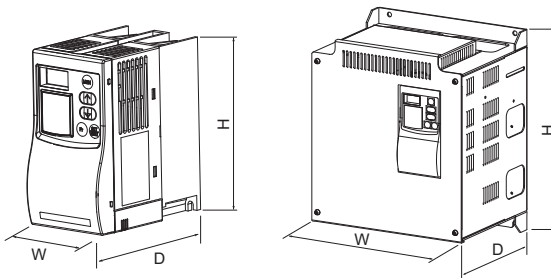

FR-BU2-1.5K to 55K
FR-BU2-H7.5K to H75K

FR-BU2-H220K, H280K

Model	W	H	D
FR-BU2-1.5K to 15K	68	128	132.5
FR-BU2-30K	108	128	129.5
FR-BU2-55K	170	128	142.5
FR-BU2-H7.5K, H15K	68	128	132.5
FR-BU2-H30K	108	128	129.5
FR-BU2-H55K, H75K	170	128	142.5
FR-BU2-H220K, H280K	250	300	200

(Unit: mm)

<GZG, GRZG>

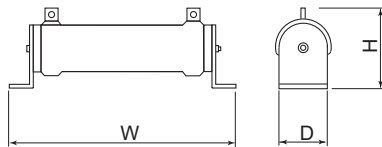

Model	W	H	D
GZG300W	335	78	40
GRZG200	306	53	26
GRZG300	334	79	40
GRZG400	411	79	40

(Unit: mm)

<FR-BR>

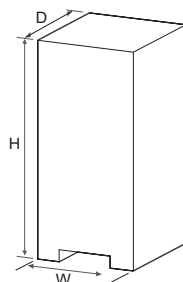

Model	W	H	D
FR-BR-15K	170	450	220
FR-BR-30K	340	600	220
FR-BR-55K	480	700	450
FR-BR-H15K	170	450	220
FR-BR-H30K	340	600	220
FR-BR-H55K	480	700	450

(Unit: mm)

<MT-BR5>

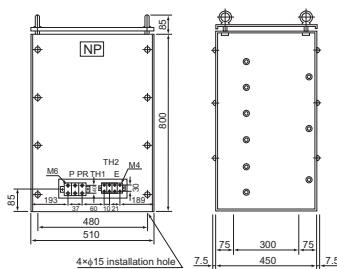



Brake unit
FR-BU2-(H)□K

Discharging resistor
GZG type
GRZG type

Resistor unit
FR-BR-(H)□K
MT-BR5-(H)□K

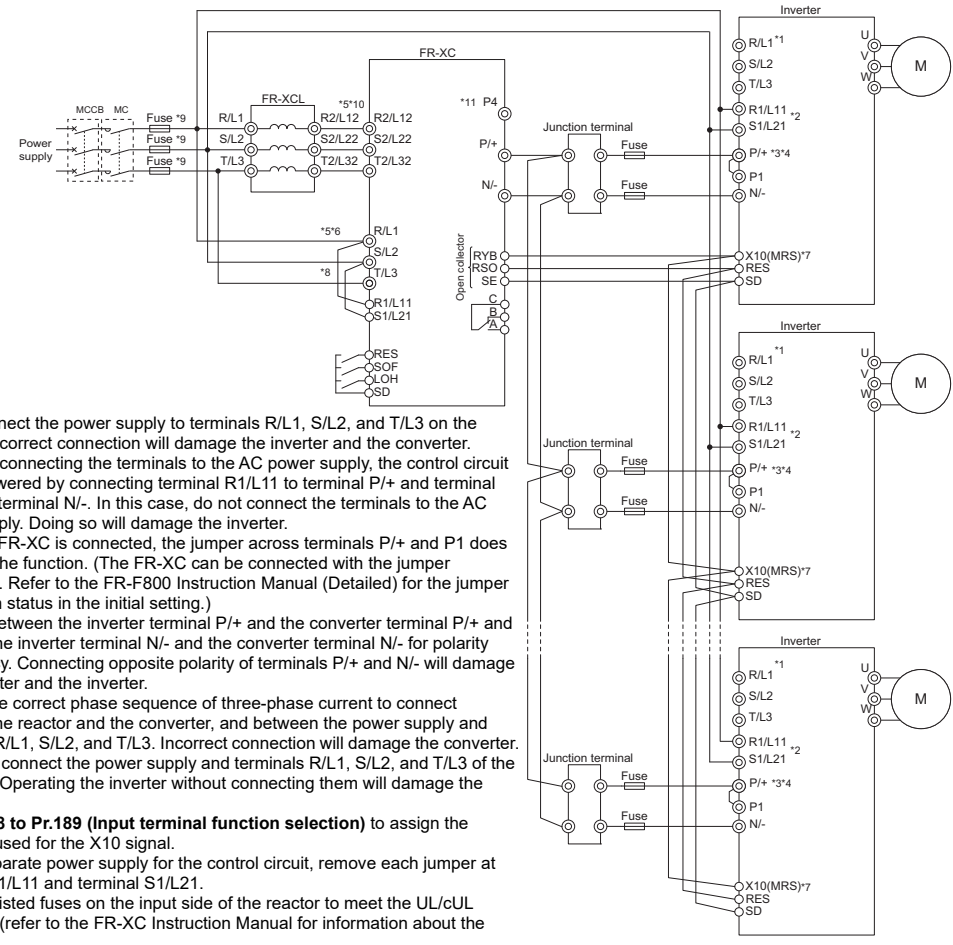

Name (model)	Specification and structure																																																																																																																																																																																																																																																																																																																																													
<p>Multifunction regeneration converter FR-XC</p> <p>Dedicated stand-alone reactor FR-XCL/FR-XCG</p> <p>Dedicated box-type reactor FR-XCB</p> 	<p>One inverter can handle harmonic suppression and power regeneration. Functions that match the application can be selected by combining the inverter/converter with the dedicated reactor FR-XCB (box-type) or FR-XCL/FR-XCG.</p> <p>• Combination</p> <p><<Combination matrix of FR-XCL/FR-XCG and FR-XC(-PWM)>></p> <table border="1" style="width: 100%; border-collapse: collapse;"> <thead> <tr> <th style="background-color: #90EE90;">Dedicated standalone reactor</th> <th colspan="2" style="background-color: #90EE90;">Multifunction regeneration converter</th> </tr> <tr> <th style="background-color: #90EE90;">FR-XCL-[] FR-XCG-[]</th> <th style="background-color: #90EE90;">FR-XC-[]</th> <th style="background-color: #90EE90;">FR-XC-[]-PWM *1</th> </tr> </thead> <tbody> <tr><td style="background-color: #90EE90;">7.5K</td><td>7.5K</td><td>-</td></tr> <tr><td style="background-color: #90EE90;">11K</td><td>11K</td><td>-</td></tr> <tr><td style="background-color: #90EE90;">15K</td><td>15K</td><td>-</td></tr> <tr><td style="background-color: #90EE90;">22K</td><td>22K</td><td>18.5K</td></tr> <tr><td style="background-color: #90EE90;">30K</td><td>30K</td><td>22K</td></tr> <tr><td style="background-color: #90EE90;">37K</td><td>37K</td><td>37K</td></tr> <tr><td style="background-color: #90EE90;">55K</td><td>55K</td><td>55K</td></tr> <tr><td style="background-color: #90EE90;">H7.5K</td><td>H7.5K</td><td>-</td></tr> <tr><td style="background-color: #90EE90;">H11K</td><td>H11K</td><td>-</td></tr> <tr><td style="background-color: #90EE90;">H15K</td><td>H15K</td><td>-</td></tr> <tr><td style="background-color: #90EE90;">H22K</td><td>H22K</td><td>H18.5K</td></tr> <tr><td style="background-color: #90EE90;">H30K</td><td>H30K</td><td>H22K</td></tr> <tr><td style="background-color: #90EE90;">H37K</td><td>H37K</td><td>H37K</td></tr> <tr><td style="background-color: #90EE90;">H55K</td><td>H55K</td><td>H55K</td></tr> <tr><td style="background-color: #90EE90;">H75K</td><td>50°C rating H75K</td><td>50°C rating H75K</td></tr> <tr><td style="background-color: #90EE90;">H90K</td><td>40°C rating H75K</td><td>40°C rating H75K</td></tr> </tbody> </table> <p><<Combination matrix of FR-XCB and FR-XC(-PWM)>></p> <table border="1" style="width: 100%; border-collapse: collapse;"> <thead> <tr> <th style="background-color: #90EE90;">Dedicated box-type reactor</th> <th colspan="2" style="background-color: #90EE90;">Multifunction regeneration converter</th> </tr> <tr> <th style="background-color: #90EE90;">FR-XCB-[]</th> <th style="background-color: #90EE90;">FR-XC-[]*2</th> <th style="background-color: #90EE90;">FR-XC-[]-PWM</th> </tr> </thead> <tbody> <tr><td style="background-color: #90EE90;">18.5K</td><td>22K</td><td>18.5K</td></tr> <tr><td style="background-color: #90EE90;">22K</td><td>30K</td><td>22K</td></tr> <tr><td style="background-color: #90EE90;">37K</td><td>37K</td><td>37K</td></tr> <tr><td style="background-color: #90EE90;">55K</td><td>55K</td><td>55K</td></tr> <tr><td style="background-color: #90EE90;">H18.5K</td><td>H22K</td><td>H18.5K</td></tr> <tr><td style="background-color: #90EE90;">H22K</td><td>H30K</td><td>H22K</td></tr> <tr><td style="background-color: #90EE90;">H37K</td><td>H37K</td><td>H37K</td></tr> <tr><td style="background-color: #90EE90;">H55K</td><td>H55K</td><td>H55K</td></tr> <tr><td style="background-color: #90EE90;">H75K</td><td>H75K</td><td>H75K</td></tr> </tbody> </table> <p>• Specifications</p> <p><<200V class>></p> <table border="1" style="width: 100%; border-collapse: collapse;"> <thead> <tr> <th colspan="2" rowspan="2" style="background-color: #90EE90;">Model*1</th> <th colspan="8" style="background-color: #90EE90;">FR-XC-[]K</th> <th colspan="4" style="background-color: #90EE90;">FR-XC-[]K-PWM</th> </tr> <tr> <th colspan="2" style="background-color: #90EE90;">Harmonic suppression</th> <th>7.5</th><th>11</th><th>15</th><th>22</th><th>30</th><th>37</th><th>55</th> <th>18.5</th><th>22</th><th>37</th><th>55</th> </tr> </thead> <tbody> <tr> <td rowspan="3" style="background-color: #90EE90;">Common bus regeneration mode</td> <td rowspan="2" style="background-color: #90EE90;">Applicable inverter capacity (kW)</td> <td style="background-color: #90EE90;">Disabled</td> <td>7.5</td><td>11</td><td>15</td><td>22</td><td>30</td><td>37</td><td>55</td> <td>22</td><td>30</td><td>37</td><td>55</td> </tr> <tr> <td style="background-color: #90EE90;">Enabled</td> <td>-</td><td>-</td><td>-</td><td>18.5</td><td>22</td><td>37</td><td>55</td> <td>18.5</td><td>22</td><td>37</td><td>55</td> </tr> <tr> <td style="background-color: #90EE90;">Overload current rating</td> <td colspan="8" style="background-color: #90EE90;">100% continuous /150% 60 s</td> <td colspan="4" style="background-color: #90EE90;">100% continuous /150% 60 s</td> </tr> <tr> <td rowspan="2" style="background-color: #90EE90;">Power regeneration mode*2</td> <td style="background-color: #90EE90;">Potential regenerative capacity (kW)</td> <td>5.5</td><td>7.5</td><td>11</td><td>18.5</td><td>22</td><td>30</td><td>45</td> <td>18.5</td><td>22</td><td>30</td><td>45</td> </tr> <tr> <td style="background-color: #90EE90;">Overload current rating</td> <td colspan="8" style="background-color: #90EE90;">100% continuous /150% 60 s</td> <td colspan="4" style="background-color: #90EE90;">100% continuous /150% 60 s</td> </tr> <tr> <td rowspan="6" style="background-color: #90EE90;">Power source</td> <td rowspan="2" style="background-color: #90EE90;">Rated input AC voltage/frequency</td> <td style="background-color: #90EE90;">Disabled</td> <td colspan="8" style="background-color: #90EE90;">Three-phase 200 to 240 V 50 Hz/60 Hz</td> <td colspan="4" style="background-color: #90EE90;">Three-phase 200 to 240 V 50 Hz/60 Hz</td> </tr> <tr> <td style="background-color: #90EE90;">Enabled</td> <td>-</td><td>-</td><td>-</td> <td colspan="5" style="background-color: #90EE90;">Three-phase 200 to 230 V 50 Hz/60 Hz*3</td> <td colspan="4" style="background-color: #90EE90;">Three-phase 200 to 230 V 50 Hz/60 Hz*4</td> </tr> <tr> <td rowspan="2" style="background-color: #90EE90;">Permissible AC voltage fluctuation</td> <td style="background-color: #90EE90;">Disabled</td> <td colspan="8" style="background-color: #90EE90;">Three-phase 170 to 264 V 50 Hz/60 Hz</td> <td colspan="4" style="background-color: #90EE90;">Three-phase 170 to 264 V 50 Hz/60 Hz</td> </tr> <tr> <td style="background-color: #90EE90;">Enabled</td> <td>-</td><td>-</td><td>-</td> <td colspan="5" style="background-color: #90EE90;">Three-phase 170 to 253 V 50 Hz/60 Hz</td> <td colspan="4" style="background-color: #90EE90;">Three-phase 170 to 253 V 50 Hz/60 Hz</td> </tr> <tr> <td rowspan="2" style="background-color: #90EE90;">Permissible frequency fluctuation</td> <td style="background-color: #90EE90;">Disabled</td> <td colspan="8" style="background-color: #90EE90;">±5%</td> <td colspan="4" style="background-color: #90EE90;">±5%</td> </tr> <tr> <td style="background-color: #90EE90;">Enabled</td> <td>-</td><td>-</td><td>-</td> <td colspan="5" style="background-color: #90EE90;">±5%</td> <td colspan="4" style="background-color: #90EE90;">±5%</td> </tr> <tr> <td colspan="2" style="background-color: #90EE90;">Input power factor</td> <td style="background-color: #90EE90;">Enabled</td> <td>-</td><td>-</td><td>-</td> <td colspan="5" style="background-color: #90EE90;">0.99 or more (when load ratio is 100%)</td> <td colspan="4" style="background-color: #90EE90;">0.99 or more (when load ratio is 100%)</td> </tr> <tr> <td colspan="3" style="background-color: #90EE90;">Approx. mass (kg)*5</td> <td>5</td><td>5</td><td>6</td><td>10.5</td><td>10.5</td><td>28</td><td>38</td> <td>10.5</td><td>10.5</td><td>28</td><td>38</td> </tr> </tbody> </table> <p><<Combination matrix of FR-MCB and FR-XC>></p> <table border="1" style="width: 100%; border-collapse: collapse;"> <thead> <tr> <th style="background-color: #90EE90;">Dedicated contactor box *3</th> <th style="background-color: #90EE90;">Multifunction regeneration converter</th> </tr> </thead> <tbody> <tr> <td style="background-color: #90EE90;">FR-MCB-H[]</td> <td style="background-color: #90EE90;">FR-XC-[] (-PWM)</td> </tr> <tr> <td style="background-color: #90EE90;">150</td> <td>H75K</td> </tr> </tbody> </table> <p><<Combination matrix of FR-XCCP and FR-XC(-PWM)>></p> <table border="1" style="width: 100%; border-collapse: collapse;"> <thead> <tr> <th style="background-color: #90EE90;">Converter installation attachment for enclosure</th> <th style="background-color: #90EE90;">Multifunction regeneration converter</th> </tr> </thead> <tbody> <tr> <td style="background-color: #90EE90;">FR-XCCP[]</td> <td style="background-color: #90EE90;">FR-XC-[]</td> </tr> <tr> <td rowspan="2" style="background-color: #90EE90;">01</td> <td style="background-color: #90EE90;">(H) 7.5K</td> </tr> <tr> <td style="background-color: #90EE90;">(H) 11K</td> </tr> <tr> <td style="background-color: #90EE90;">02</td> <td style="background-color: #90EE90;">(H) 15K</td> </tr> <tr> <td rowspan="4" style="background-color: #90EE90;">03</td> <td style="background-color: #90EE90;">(H) 22K</td> </tr> <tr> <td style="background-color: #90EE90;">(H) 30K</td> </tr> <tr> <td style="background-color: #90EE90;">(H) 18.5K-PWM</td> </tr> <tr> <td style="background-color: #90EE90;">(H) 22K-PWM</td> </tr> </tbody> </table> <p><<Combination matrix of FR-XCCU and FR-XC(-PWM)>></p> <table border="1" style="width: 100%; border-collapse: collapse;"> <thead> <tr> <th style="background-color: #90EE90;">IP20 compatible attachment</th> <th style="background-color: #90EE90;">Multifunction regeneration converter</th> </tr> </thead> <tbody> <tr> <td style="background-color: #90EE90;">FR-XCCU[]</td> <td style="background-color: #90EE90;">FR-XC-[] (-PWM)</td> </tr> <tr> <td style="background-color: #90EE90;">01</td> <td>37K</td> </tr> <tr> <td style="background-color: #90EE90;">02</td> <td>H55K</td> </tr> <tr> <td style="background-color: #90EE90;">03</td> <td>55K</td> </tr> <tr> <td></td> <td>H37K</td> </tr> </tbody> </table> <p>*1 The harmonic suppression function is pre-enabled in this model. To use the converter with the FR-XCL, change the "9999" setting of Pr.416 Control method selection to "0" (harmonic suppression disabled).</p> <p>*2 The harmonic suppression function is not pre-enabled in this model. To use the converter with the FR-XCB, change the "9999" setting of Pr.416 Control method selection to "1" (harmonic suppression enabled).</p> <p>*3 A dedicated contactor box used for coordination with the charging circuit.</p>												Dedicated standalone reactor	Multifunction regeneration converter		FR-XCL-[] FR-XCG-[]	FR-XC-[]	FR-XC-[]-PWM *1	7.5K	7.5K	-	11K	11K	-	15K	15K	-	22K	22K	18.5K	30K	30K	22K	37K	37K	37K	55K	55K	55K	H7.5K	H7.5K	-	H11K	H11K	-	H15K	H15K	-	H22K	H22K	H18.5K	H30K	H30K	H22K	H37K	H37K	H37K	H55K	H55K	H55K	H75K	50°C rating H75K	50°C rating H75K	H90K	40°C rating H75K	40°C rating H75K	Dedicated box-type reactor	Multifunction regeneration converter		FR-XCB-[]	FR-XC-[]*2	FR-XC-[]-PWM	18.5K	22K	18.5K	22K	30K	22K	37K	37K	37K	55K	55K	55K	H18.5K	H22K	H18.5K	H22K	H30K	H22K	H37K	H37K	H37K	H55K	H55K	H55K	H75K	H75K	H75K	Model*1		FR-XC-[]K								FR-XC-[]K-PWM				Harmonic suppression		7.5	11	15	22	30	37	55	18.5	22	37	55	Common bus regeneration mode	Applicable inverter capacity (kW)	Disabled	7.5	11	15	22	30	37	55	22	30	37	55	Enabled	-	-	-	18.5	22	37	55	18.5	22	37	55	Overload current rating	100% continuous /150% 60 s								100% continuous /150% 60 s				Power regeneration mode*2	Potential regenerative capacity (kW)	5.5	7.5	11	18.5	22	30	45	18.5	22	30	45	Overload current rating	100% continuous /150% 60 s								100% continuous /150% 60 s				Power source	Rated input AC voltage/frequency	Disabled	Three-phase 200 to 240 V 50 Hz/60 Hz								Three-phase 200 to 240 V 50 Hz/60 Hz				Enabled	-	-	-	Three-phase 200 to 230 V 50 Hz/60 Hz*3					Three-phase 200 to 230 V 50 Hz/60 Hz*4				Permissible AC voltage fluctuation	Disabled	Three-phase 170 to 264 V 50 Hz/60 Hz								Three-phase 170 to 264 V 50 Hz/60 Hz				Enabled	-	-	-	Three-phase 170 to 253 V 50 Hz/60 Hz					Three-phase 170 to 253 V 50 Hz/60 Hz				Permissible frequency fluctuation	Disabled	±5%								±5%				Enabled	-	-	-	±5%					±5%				Input power factor		Enabled	-	-	-	0.99 or more (when load ratio is 100%)					0.99 or more (when load ratio is 100%)				Approx. mass (kg)*5			5	5	6	10.5	10.5	28	38	10.5	10.5	28	38	Dedicated contactor box *3	Multifunction regeneration converter	FR-MCB-H[]	FR-XC-[] (-PWM)	150	H75K	Converter installation attachment for enclosure	Multifunction regeneration converter	FR-XCCP[]	FR-XC-[]	01	(H) 7.5K	(H) 11K	02	(H) 15K	03	(H) 22K	(H) 30K	(H) 18.5K-PWM	(H) 22K-PWM	IP20 compatible attachment	Multifunction regeneration converter	FR-XCCU[]	FR-XC-[] (-PWM)	01	37K	02	H55K	03	55K		H37K
	Dedicated standalone reactor	Multifunction regeneration converter																																																																																																																																																																																																																																																																																																																																												
	FR-XCL-[] FR-XCG-[]	FR-XC-[]	FR-XC-[]-PWM *1																																																																																																																																																																																																																																																																																																																																											
	7.5K	7.5K	-																																																																																																																																																																																																																																																																																																																																											
	11K	11K	-																																																																																																																																																																																																																																																																																																																																											
	15K	15K	-																																																																																																																																																																																																																																																																																																																																											
	22K	22K	18.5K																																																																																																																																																																																																																																																																																																																																											
	30K	30K	22K																																																																																																																																																																																																																																																																																																																																											
	37K	37K	37K																																																																																																																																																																																																																																																																																																																																											
	55K	55K	55K																																																																																																																																																																																																																																																																																																																																											
	H7.5K	H7.5K	-																																																																																																																																																																																																																																																																																																																																											
	H11K	H11K	-																																																																																																																																																																																																																																																																																																																																											
	H15K	H15K	-																																																																																																																																																																																																																																																																																																																																											
	H22K	H22K	H18.5K																																																																																																																																																																																																																																																																																																																																											
	H30K	H30K	H22K																																																																																																																																																																																																																																																																																																																																											
H37K	H37K	H37K																																																																																																																																																																																																																																																																																																																																												
H55K	H55K	H55K																																																																																																																																																																																																																																																																																																																																												
H75K	50°C rating H75K	50°C rating H75K																																																																																																																																																																																																																																																																																																																																												
H90K	40°C rating H75K	40°C rating H75K																																																																																																																																																																																																																																																																																																																																												
Dedicated box-type reactor	Multifunction regeneration converter																																																																																																																																																																																																																																																																																																																																													
FR-XCB-[]	FR-XC-[]*2	FR-XC-[]-PWM																																																																																																																																																																																																																																																																																																																																												
18.5K	22K	18.5K																																																																																																																																																																																																																																																																																																																																												
22K	30K	22K																																																																																																																																																																																																																																																																																																																																												
37K	37K	37K																																																																																																																																																																																																																																																																																																																																												
55K	55K	55K																																																																																																																																																																																																																																																																																																																																												
H18.5K	H22K	H18.5K																																																																																																																																																																																																																																																																																																																																												
H22K	H30K	H22K																																																																																																																																																																																																																																																																																																																																												
H37K	H37K	H37K																																																																																																																																																																																																																																																																																																																																												
H55K	H55K	H55K																																																																																																																																																																																																																																																																																																																																												
H75K	H75K	H75K																																																																																																																																																																																																																																																																																																																																												
Model*1		FR-XC-[]K								FR-XC-[]K-PWM																																																																																																																																																																																																																																																																																																																																				
		Harmonic suppression		7.5	11	15	22	30	37	55	18.5	22	37	55																																																																																																																																																																																																																																																																																																																																
Common bus regeneration mode	Applicable inverter capacity (kW)	Disabled	7.5	11	15	22	30	37	55	22	30	37	55																																																																																																																																																																																																																																																																																																																																	
		Enabled	-	-	-	18.5	22	37	55	18.5	22	37	55																																																																																																																																																																																																																																																																																																																																	
	Overload current rating	100% continuous /150% 60 s								100% continuous /150% 60 s																																																																																																																																																																																																																																																																																																																																				
Power regeneration mode*2	Potential regenerative capacity (kW)	5.5	7.5	11	18.5	22	30	45	18.5	22	30	45																																																																																																																																																																																																																																																																																																																																		
	Overload current rating	100% continuous /150% 60 s								100% continuous /150% 60 s																																																																																																																																																																																																																																																																																																																																				
Power source	Rated input AC voltage/frequency	Disabled	Three-phase 200 to 240 V 50 Hz/60 Hz								Three-phase 200 to 240 V 50 Hz/60 Hz																																																																																																																																																																																																																																																																																																																																			
		Enabled	-	-	-	Three-phase 200 to 230 V 50 Hz/60 Hz*3					Three-phase 200 to 230 V 50 Hz/60 Hz*4																																																																																																																																																																																																																																																																																																																																			
	Permissible AC voltage fluctuation	Disabled	Three-phase 170 to 264 V 50 Hz/60 Hz								Three-phase 170 to 264 V 50 Hz/60 Hz																																																																																																																																																																																																																																																																																																																																			
		Enabled	-	-	-	Three-phase 170 to 253 V 50 Hz/60 Hz					Three-phase 170 to 253 V 50 Hz/60 Hz																																																																																																																																																																																																																																																																																																																																			
	Permissible frequency fluctuation	Disabled	±5%								±5%																																																																																																																																																																																																																																																																																																																																			
		Enabled	-	-	-	±5%					±5%																																																																																																																																																																																																																																																																																																																																			
Input power factor		Enabled	-	-	-	0.99 or more (when load ratio is 100%)					0.99 or more (when load ratio is 100%)																																																																																																																																																																																																																																																																																																																																			
Approx. mass (kg)*5			5	5	6	10.5	10.5	28	38	10.5	10.5	28	38																																																																																																																																																																																																																																																																																																																																	
Dedicated contactor box *3	Multifunction regeneration converter																																																																																																																																																																																																																																																																																																																																													
FR-MCB-H[]	FR-XC-[] (-PWM)																																																																																																																																																																																																																																																																																																																																													
150	H75K																																																																																																																																																																																																																																																																																																																																													
Converter installation attachment for enclosure	Multifunction regeneration converter																																																																																																																																																																																																																																																																																																																																													
FR-XCCP[]	FR-XC-[]																																																																																																																																																																																																																																																																																																																																													
01	(H) 7.5K																																																																																																																																																																																																																																																																																																																																													
	(H) 11K																																																																																																																																																																																																																																																																																																																																													
02	(H) 15K																																																																																																																																																																																																																																																																																																																																													
03	(H) 22K																																																																																																																																																																																																																																																																																																																																													
	(H) 30K																																																																																																																																																																																																																																																																																																																																													
	(H) 18.5K-PWM																																																																																																																																																																																																																																																																																																																																													
	(H) 22K-PWM																																																																																																																																																																																																																																																																																																																																													
IP20 compatible attachment	Multifunction regeneration converter																																																																																																																																																																																																																																																																																																																																													
FR-XCCU[]	FR-XC-[] (-PWM)																																																																																																																																																																																																																																																																																																																																													
01	37K																																																																																																																																																																																																																																																																																																																																													
02	H55K																																																																																																																																																																																																																																																																																																																																													
03	55K																																																																																																																																																																																																																																																																																																																																													
	H37K																																																																																																																																																																																																																																																																																																																																													

Name (model)		Specification and structure															
<p>Multifunction regeneration converter FR-XC</p> <p>Dedicated stand-alone reactor FR-XCL/FR-XCG</p> <p>Dedicated box-type reactor FR-XCB</p> 		<<400V class>>															
		Model*1		FR-XC-HI [JK]							FR-XC-HI [JK-PWM]						
		Common bus regeneration mode	Applicable inverter capacity (kW)	Harmonic suppression	7.5	11	15	22	30	37	55	75	18.5	22	37	55	75
				Disabled	7.5	11	15	22	30	37	55	75*6	22	30	37	55	75*6
				Enabled	-	-	-	18.5	22	37	55	75*6	18.5	22	37	55	75*6
				Overload current rating	100% continuous /150% 60 s							100% continuous /150% 60 s					
		Power regeneration mode*2	Potential regenerative capacity (kW)	Disabled	5.5	7.5	11	18.5	22	30	45	75*6	18.5	22	30	45	75*6
				Enabled	-	-	-	-	-	-	-	-	-	-	-	-	-
				Overload current rating	100% continuous /150% 60 s							100% continuous /150% 60s					
		Power source	Rated input AC voltage/frequency	Disabled	Three-phase 380 to 500 V 50 Hz/60 Hz							Three-phase 380 to 500 V 50 Hz/60 Hz					
				Enabled	-	-	-	Three-phase 380 to 480 V 50 Hz/60 Hz*3			Three-phase 380 to 480 V 50 Hz/60 Hz*4						
			Permissible AC voltage fluctuation	Disabled	Three-phase 323 to 550 V 50 Hz/60 Hz							Three-phase 323 to 550 V 50 Hz/60 Hz					
				Enabled	-	-	-	Three-phase 323 to 506 V 50 Hz/60 Hz			Three-phase 323 to 506 V 50 Hz/60 Hz						
			Permissible frequency fluctuation	Disabled	±5%							±5%					
				Enabled	-	-	-	±5%			±5%						
Input power factor		Enabled	-	-	-	0.99 or more (when load ratio is 100%)				0.99 or more (when load ratio is 100%)							
Approx. mass (kg)*5			5	5	6	10.5	10.5	28	28	45	10.5	10.5	28	28	45		
		*1	The harmonic suppression function is not pre-enabled in this model.														
		*2	The power regeneration mode is selectable when the harmonic suppression function is disabled.														
		*3	The DC bus voltage is approx. 297 VDC at an input voltage of 200 VAC, approx. 327 VDC at 220 VAC, and approx. 342 VDC at 230 VAC.														
		*4	The DC bus voltage is approx. 594 VDC at an input voltage of 400 VAC, approx. 653 VDC at 440 VAC, and approx. 713 VDC at 480 VAC.														
		*5	Mass of the FR-XC alone.														
		*6	90 kW for the 40°C rating														
		• Connection diagram <<Common bus regeneration mode with harmonic suppression disabled>>															
																	
		*1	Never connect the power supply to terminals R/L1, S/L2, and T/L3 on the inverter. Incorrect connection will damage the inverter and the converter.														
		*2	Instead of connecting the terminals to the AC power supply, the control circuit can be powered by connecting terminal R1/L11 to terminal P/+ and terminal S1/L21 to terminal N/-. In this case, do not connect the terminals to the AC power supply. Doing so will damage the inverter.														
		*3	When the FR-XC is connected, the jumper across terminals P/+ and P1 does not affect the function. (The FR-XC can be connected with the jumper connected. Refer to the FR-F800 Instruction Manual (Detailed) for the jumper connection status in the initial setting.)														
		*4	Connect between the inverter terminal P/+ and the converter terminal P/+ and between the inverter terminal N/- and the converter terminal N/- for polarity consistency. Connecting opposite polarity of terminals P/+ and N/- will damage the converter and the inverter.														
		*5	Confirm the correct phase sequence of three-phase current to connect between the reactor and the converter, and between the power supply and terminals R/L1, S/L2, and T/L3. Incorrect connection will damage the converter.														
		*6	Be sure to connect the power supply and terminals R/L1, S/L2, and T/L3 of the converter. Operating the inverter without connecting them will damage the converter.														
		*7	Use Pr.178 to Pr.189 (Input terminal function selection) to assign the terminals used for the X10 signal.														
		*8	To use separate power supply for the control circuit, remove each jumper at terminal R1/L11 and terminal S1/L21.														
		*9	Install UL listed fuses on the input side of the reactor to meet the UL/cUL standards (refer to the FR-XC Instruction Manual for information about the fuse).														
		*10	Do not install an MCCB or MC between the reactor and the converter. Doing so disrupts proper operation.														
		*11	Do not connect anything to terminal P4.														

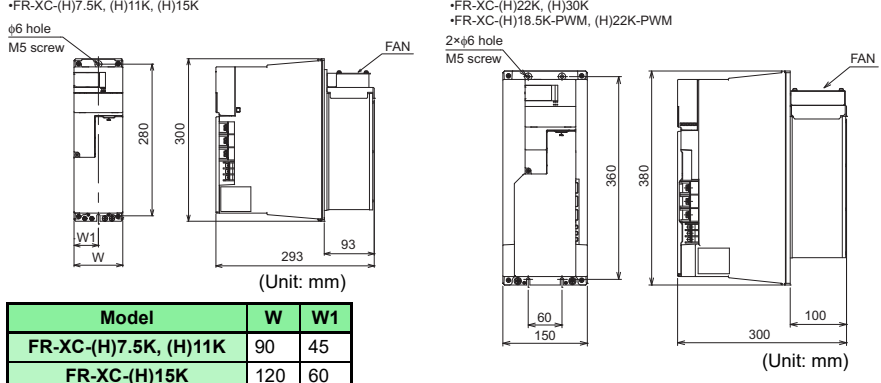
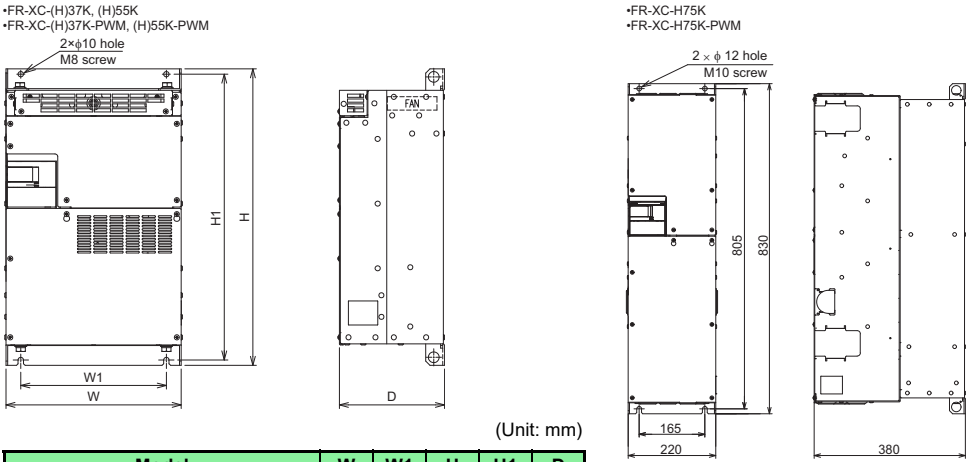
Name (model)	Specification and structure																											
<p>Multifunction regeneration converter FR-XC</p> <p>Dedicated stand-alone reactor FR-XCL/FR-XCG</p> <p>Dedicated box-type reactor FR-XCB</p> 	<p>• Outline dimension drawings This is an example of the outer appearance, which differs depending on the model. <<Multifunction regeneration converter FR-XC (-PWM)>></p> <p>•FR-XC-(H)7.5K, (H)11K, (H)15K •FR-XC-(H)22K, (H)30K •FR-XC-(H)18.5K-PWM, (H)22K-PWM</p>  <p>(Unit: mm)</p> <table border="1" data-bbox="391 600 742 694"> <thead> <tr> <th>Model</th> <th>W</th> <th>W1</th> </tr> </thead> <tbody> <tr> <td>FR-XC-(H)7.5K, (H)11K</td> <td>90</td> <td>45</td> </tr> <tr> <td>FR-XC-(H)15K</td> <td>120</td> <td>60</td> </tr> </tbody> </table> <p>•FR-XC-(H)37K, (H)55K •FR-XC-(H)37K-PWM, (H)55K-PWM •FR-XC-H75K •FR-XC-H75K-PWM</p>  <p>(Unit: mm)</p> <table border="1" data-bbox="391 1176 981 1310"> <thead> <tr> <th>Model</th> <th>W</th> <th>W1</th> <th>H</th> <th>H1</th> <th>D</th> </tr> </thead> <tbody> <tr> <td>FR-XC-(H)37K, H55K FR-XC-(H)37K-PWM, H55K-PWM</td> <td>325</td> <td>270</td> <td>550</td> <td>530</td> <td>195</td> </tr> <tr> <td>FR-XC-55K FR-XC-55K-PWM</td> <td>370</td> <td>300</td> <td>620</td> <td>600</td> <td>250</td> </tr> </tbody> </table>	Model	W	W1	FR-XC-(H)7.5K, (H)11K	90	45	FR-XC-(H)15K	120	60	Model	W	W1	H	H1	D	FR-XC-(H)37K, H55K FR-XC-(H)37K-PWM, H55K-PWM	325	270	550	530	195	FR-XC-55K FR-XC-55K-PWM	370	300	620	600	250
Model	W	W1																										
FR-XC-(H)7.5K, (H)11K	90	45																										
FR-XC-(H)15K	120	60																										
Model	W	W1	H	H1	D																							
FR-XC-(H)37K, H55K FR-XC-(H)37K-PWM, H55K-PWM	325	270	550	530	195																							
FR-XC-55K FR-XC-55K-PWM	370	300	620	600	250																							

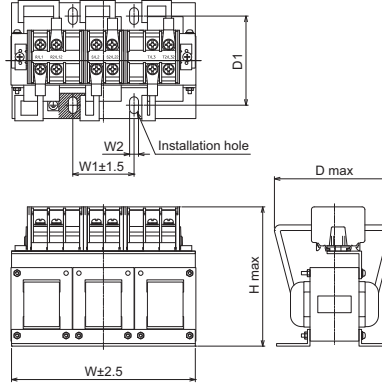
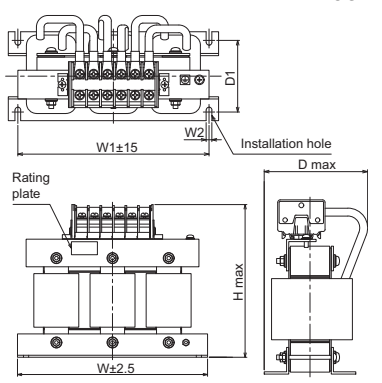
Name (model)	Specification and structure																																																																																														
<p>Multifunction regeneration converter FR-XC</p> <p>Dedicated stand-alone reactor FR-XCL/FR-XCG</p> <p>Dedicated box-type reactor FR-XCB</p> 	<<Dedicated stand-alone reactor FR-XCL>>																																																																																														
	200 V class (Unit: mm)																																																																																														
	 <table border="1" data-bbox="750 280 1436 548"> <thead> <tr> <th>Model</th> <th>W</th> <th>W1</th> <th>W2</th> <th>H</th> <th>D</th> <th>D1</th> <th>Mounting screw size</th> <th>Terminal screw size</th> <th>Mass</th> </tr> </thead> <tbody> <tr> <td>FR-XCL-7.5K</td> <td rowspan="2">165</td> <td rowspan="2">55</td> <td rowspan="2">8</td> <td>125</td> <td>120</td> <td>80±2</td> <td rowspan="2">M6</td> <td rowspan="2">M5</td> <td>3.9kg</td> </tr> <tr> <td>FR-XCL-11K</td> <td></td> <td></td> <td></td> <td>73±2</td> <td>3.6kg</td> </tr> <tr> <td>FR-XCL-15K</td> <td rowspan="2">192</td> <td rowspan="2">70</td> <td rowspan="2">8</td> <td>130</td> <td>130</td> <td>100±2</td> <td rowspan="2">M6</td> <td rowspan="2">M6</td> <td>5.5kg</td> </tr> <tr> <td>FR-XCL-22K</td> <td></td> <td></td> <td></td> <td>140</td> <td>110±2</td> <td>6.3kg</td> </tr> <tr> <td>FR-XCL-30K</td> <td>240</td> <td>70</td> <td></td> <td>150</td> <td>160</td> <td>119±2</td> <td rowspan="2">M8</td> <td rowspan="2">M10</td> <td>10.0kg</td> </tr> <tr> <td>FR-XCL-37K</td> <td>248</td> <td>200</td> <td>10</td> <td>190</td> <td>240</td> <td>120±5</td> <td>12.0kg</td> </tr> <tr> <td>FR-XCL-55K</td> <td>250</td> <td>225</td> <td></td> <td>190</td> <td>260</td> <td>135±5</td> <td></td> <td></td> <td>15.5kg</td> </tr> </tbody> </table>										Model	W	W1	W2	H	D	D1	Mounting screw size	Terminal screw size	Mass	FR-XCL-7.5K	165	55	8	125	120	80±2	M6	M5	3.9kg	FR-XCL-11K				73±2	3.6kg	FR-XCL-15K	192	70	8	130	130	100±2	M6	M6	5.5kg	FR-XCL-22K				140	110±2	6.3kg	FR-XCL-30K	240	70		150	160	119±2	M8	M10	10.0kg	FR-XCL-37K	248	200	10	190	240	120±5	12.0kg	FR-XCL-55K	250	225		190	260	135±5			15.5kg														
	Model	W	W1	W2	H	D	D1	Mounting screw size	Terminal screw size	Mass																																																																																					
	FR-XCL-7.5K	165	55	8	125	120	80±2	M6	M5	3.9kg																																																																																					
	FR-XCL-11K									73±2	3.6kg																																																																																				
	FR-XCL-15K	192	70	8	130	130	100±2	M6	M6	5.5kg																																																																																					
	FR-XCL-22K									140	110±2	6.3kg																																																																																			
	FR-XCL-30K	240	70		150	160	119±2	M8	M10	10.0kg																																																																																					
	FR-XCL-37K	248	200	10	190	240	120±5			12.0kg																																																																																					
FR-XCL-55K	250	225		190	260	135±5			15.5kg																																																																																						
400 V class (Unit: mm)																																																																																															
<table border="1" data-bbox="750 593 1436 907"> <thead> <tr> <th>Model</th> <th>W</th> <th>W1</th> <th>W2</th> <th>H</th> <th>D</th> <th>D1</th> <th>Mounting screw size</th> <th>Terminal screw size</th> <th>Mass</th> </tr> </thead> <tbody> <tr> <td>FR-XCL-H7.5K</td> <td rowspan="3">165</td> <td rowspan="3">55</td> <td rowspan="3">8</td> <td rowspan="3">125</td> <td>120</td> <td>73±2</td> <td rowspan="3">M6</td> <td rowspan="3">M5</td> <td>3.7kg</td> </tr> <tr> <td>FR-XCL-H11K</td> <td></td> <td></td> <td></td> <td>80±2</td> <td>4.2kg</td> </tr> <tr> <td>FR-XCL-H15K</td> <td></td> <td></td> <td></td> <td>135</td> <td>110±2</td> <td>6.0kg</td> </tr> <tr> <td>FR-XCL-H22K</td> <td rowspan="2">240</td> <td rowspan="2">70</td> <td rowspan="2">8</td> <td rowspan="2">150</td> <td>150</td> <td>109±2</td> <td rowspan="2">M6</td> <td rowspan="2">M6</td> <td>9.0kg</td> </tr> <tr> <td>FR-XCL-H30K</td> <td></td> <td></td> <td></td> <td>170</td> <td>129±2</td> <td>12.0kg</td> </tr> <tr> <td>FR-XCL-H37K</td> <td>220</td> <td>200</td> <td>10</td> <td>190</td> <td>230</td> <td>120±5</td> <td rowspan="2">M8</td> <td rowspan="2">M8</td> <td>12.0kg</td> </tr> <tr> <td>FR-XCL-H55K</td> <td>250</td> <td>225</td> <td></td> <td>190</td> <td>230</td> <td>135±5</td> <td>16.0kg</td> </tr> <tr> <td>FR-XCL-H75K</td> <td>300</td> <td>270</td> <td>10</td> <td>335</td> <td>200</td> <td>140±2</td> <td rowspan="2">M8</td> <td rowspan="2">M8</td> <td>50.0 kg</td> </tr> <tr> <td>FR-XCL-H90K</td> <td>300</td> <td>270</td> <td>10</td> <td>360</td> <td>210</td> <td>150±2</td> <td>60.0 kg</td> </tr> </tbody> </table>										Model	W	W1	W2	H	D	D1	Mounting screw size	Terminal screw size	Mass	FR-XCL-H7.5K	165	55	8	125	120	73±2	M6	M5	3.7kg	FR-XCL-H11K				80±2	4.2kg	FR-XCL-H15K				135	110±2	6.0kg	FR-XCL-H22K	240	70	8	150	150	109±2	M6	M6	9.0kg	FR-XCL-H30K				170	129±2	12.0kg	FR-XCL-H37K	220	200	10	190	230	120±5	M8	M8	12.0kg	FR-XCL-H55K	250	225		190	230	135±5	16.0kg	FR-XCL-H75K	300	270	10	335	200	140±2	M8	M8	50.0 kg	FR-XCL-H90K	300	270	10	360	210	150±2	60.0 kg
Model	W	W1	W2	H	D	D1	Mounting screw size	Terminal screw size	Mass																																																																																						
FR-XCL-H7.5K	165	55	8	125	120	73±2	M6	M5	3.7kg																																																																																						
FR-XCL-H11K										80±2	4.2kg																																																																																				
FR-XCL-H15K										135	110±2	6.0kg																																																																																			
FR-XCL-H22K	240	70	8	150	150	109±2	M6	M6	9.0kg																																																																																						
FR-XCL-H30K										170	129±2	12.0kg																																																																																			
FR-XCL-H37K	220	200	10	190	230	120±5	M8	M8	12.0kg																																																																																						
FR-XCL-H55K	250	225		190	230	135±5			16.0kg																																																																																						
FR-XCL-H75K	300	270	10	335	200	140±2	M8	M8	50.0 kg																																																																																						
FR-XCL-H90K	300	270	10	360	210	150±2			60.0 kg																																																																																						
<<Dedicated stand-alone reactor FR-XCG>>																																																																																															
200 V class (Unit: mm)																																																																																															
 <table border="1" data-bbox="750 996 1436 1265"> <thead> <tr> <th>Model</th> <th>W</th> <th>W1</th> <th>W2</th> <th>H</th> <th>D</th> <th>D1</th> <th>Mounting screw size</th> <th>Terminal screw size</th> <th>Mass</th> </tr> </thead> <tbody> <tr> <td>FR-XCG-7.5K</td> <td rowspan="3">220</td> <td rowspan="3">200</td> <td rowspan="3">6</td> <td rowspan="3">185</td> <td>115</td> <td>60±1.5</td> <td rowspan="3">M5</td> <td rowspan="3">M5</td> <td>5 kg</td> </tr> <tr> <td>FR-XCG-11K</td> <td></td> <td></td> <td></td> <td>120</td> <td>75±1.5</td> <td>8 kg</td> </tr> <tr> <td>FR-XCG-15K</td> <td></td> <td></td> <td></td> <td>190</td> <td>90±1.5</td> <td>11 kg</td> </tr> <tr> <td>FR-XCG-22K</td> <td rowspan="2">255</td> <td rowspan="2">225</td> <td rowspan="2">8</td> <td rowspan="2">240</td> <td>140</td> <td>85±1.5</td> <td rowspan="2">M6</td> <td rowspan="2">M6</td> <td>16 kg</td> </tr> <tr> <td>FR-XCG-30K</td> <td></td> <td></td> <td></td> <td>155</td> <td>100±1.5</td> <td>20 kg</td> </tr> <tr> <td>FR-XCG-37K</td> <td rowspan="2">300</td> <td rowspan="2">270</td> <td rowspan="2">10</td> <td rowspan="2">285</td> <td>180</td> <td>100±1.5</td> <td rowspan="2">M8</td> <td rowspan="2">M10</td> <td>25 kg</td> </tr> <tr> <td>FR-XCG-55K</td> <td></td> <td></td> <td></td> <td>190</td> <td>130±1.5</td> <td>40 kg</td> </tr> </tbody> </table>										Model	W	W1	W2	H	D	D1	Mounting screw size	Terminal screw size	Mass	FR-XCG-7.5K	220	200	6	185	115	60±1.5	M5	M5	5 kg	FR-XCG-11K				120	75±1.5	8 kg	FR-XCG-15K				190	90±1.5	11 kg	FR-XCG-22K	255	225	8	240	140	85±1.5	M6	M6	16 kg	FR-XCG-30K				155	100±1.5	20 kg	FR-XCG-37K	300	270	10	285	180	100±1.5	M8	M10	25 kg	FR-XCG-55K				190	130±1.5	40 kg																		
Model	W	W1	W2	H	D	D1	Mounting screw size	Terminal screw size	Mass																																																																																						
FR-XCG-7.5K	220	200	6	185	115	60±1.5	M5	M5	5 kg																																																																																						
FR-XCG-11K										120	75±1.5	8 kg																																																																																			
FR-XCG-15K										190	90±1.5	11 kg																																																																																			
FR-XCG-22K	255	225	8	240	140	85±1.5	M6	M6	16 kg																																																																																						
FR-XCG-30K										155	100±1.5	20 kg																																																																																			
FR-XCG-37K	300	270	10	285	180	100±1.5	M8	M10	25 kg																																																																																						
FR-XCG-55K										190	130±1.5	40 kg																																																																																			
400 V class (Unit: mm)																																																																																															
<table border="1" data-bbox="750 1310 1436 1635"> <thead> <tr> <th>Model</th> <th>W</th> <th>W1</th> <th>W2</th> <th>H</th> <th>D</th> <th>D1</th> <th>Mounting screw size</th> <th>Terminal screw size</th> <th>Mass</th> </tr> </thead> <tbody> <tr> <td>FR-XCG-H7.5K</td> <td rowspan="3">220</td> <td rowspan="3">200</td> <td rowspan="3">6</td> <td rowspan="3">185</td> <td>115</td> <td>60±1.5</td> <td rowspan="3">M5</td> <td rowspan="3">M5</td> <td>5 kg</td> </tr> <tr> <td>FR-XCG-H11K</td> <td></td> <td></td> <td></td> <td>120</td> <td>75±1.5</td> <td>8 kg</td> </tr> <tr> <td>FR-XCG-H15K</td> <td></td> <td></td> <td></td> <td>130</td> <td>90±1.5</td> <td>11 kg</td> </tr> <tr> <td>FR-XCG-H22K</td> <td rowspan="2">255</td> <td rowspan="2">225</td> <td rowspan="2">8</td> <td rowspan="2">240</td> <td>140</td> <td>85±1.5</td> <td rowspan="2">M6</td> <td rowspan="2">M6</td> <td>16 kg</td> </tr> <tr> <td>FR-XCG-H30K</td> <td></td> <td></td> <td></td> <td>140</td> <td>100±1.5</td> <td>20 kg</td> </tr> <tr> <td>FR-XCG-H37K</td> <td rowspan="2">300</td> <td rowspan="2">270</td> <td rowspan="2">10</td> <td rowspan="2">285</td> <td>180</td> <td>100±1.5</td> <td rowspan="2">M8</td> <td rowspan="2">M8</td> <td>25 kg</td> </tr> <tr> <td>FR-XCG-H55K</td> <td></td> <td></td> <td></td> <td>190</td> <td>130±1.5</td> <td>40 kg</td> </tr> <tr> <td>FR-XCG-H75K</td> <td>300</td> <td>270</td> <td>10</td> <td>335</td> <td>200</td> <td>140±2</td> <td rowspan="2">M8</td> <td rowspan="2">M8</td> <td>50 kg</td> </tr> <tr> <td>FR-XCG-H90K</td> <td>300</td> <td>270</td> <td>10</td> <td>360</td> <td>210</td> <td>150±2</td> <td>60 kg</td> </tr> </tbody> </table>										Model	W	W1	W2	H	D	D1	Mounting screw size	Terminal screw size	Mass	FR-XCG-H7.5K	220	200	6	185	115	60±1.5	M5	M5	5 kg	FR-XCG-H11K				120	75±1.5	8 kg	FR-XCG-H15K				130	90±1.5	11 kg	FR-XCG-H22K	255	225	8	240	140	85±1.5	M6	M6	16 kg	FR-XCG-H30K				140	100±1.5	20 kg	FR-XCG-H37K	300	270	10	285	180	100±1.5	M8	M8	25 kg	FR-XCG-H55K				190	130±1.5	40 kg	FR-XCG-H75K	300	270	10	335	200	140±2	M8	M8	50 kg	FR-XCG-H90K	300	270	10	360	210	150±2	60 kg
Model	W	W1	W2	H	D	D1	Mounting screw size	Terminal screw size	Mass																																																																																						
FR-XCG-H7.5K	220	200	6	185	115	60±1.5	M5	M5	5 kg																																																																																						
FR-XCG-H11K										120	75±1.5	8 kg																																																																																			
FR-XCG-H15K										130	90±1.5	11 kg																																																																																			
FR-XCG-H22K	255	225	8	240	140	85±1.5	M6	M6	16 kg																																																																																						
FR-XCG-H30K										140	100±1.5	20 kg																																																																																			
FR-XCG-H37K	300	270	10	285	180	100±1.5	M8	M8	25 kg																																																																																						
FR-XCG-H55K										190	130±1.5	40 kg																																																																																			
FR-XCG-H75K	300	270	10	335	200	140±2	M8	M8	50 kg																																																																																						
FR-XCG-H90K	300	270	10	360	210	150±2			60 kg																																																																																						

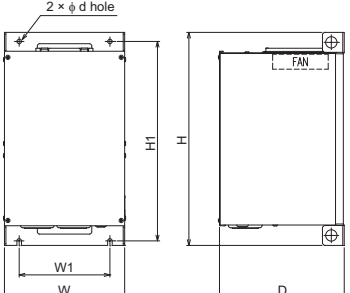
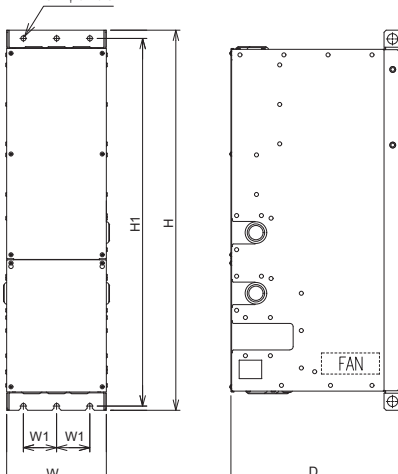
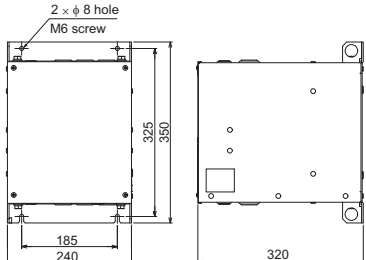
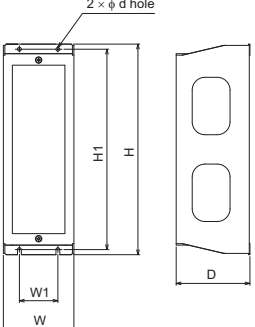
Name (model)	Specification and structure																																								
<p>Multifunction regeneration converter FR-XC</p> <p>Dedicated stand-alone reactor FR-XCL/FR-XCG</p> <p>Dedicated box-type reactor FR-XCB</p> 	<p><<Dedicated box-type reactor FR-XCB>> FR-XCB-(H)55K or less</p> 	<p>200 V class (Unit: mm)</p> <table border="1"> <thead> <tr> <th>Model</th> <th>W</th> <th>W1</th> <th>H</th> <th>H1</th> <th>D</th> <th>d</th> <th>Screw size</th> <th>Mass</th> </tr> </thead> <tbody> <tr> <td>FR-XCB-18.5K</td> <td rowspan="2">265</td> <td rowspan="2">200</td> <td rowspan="2">470</td> <td rowspan="2">440</td> <td rowspan="2">275</td> <td rowspan="2">10</td> <td rowspan="2">M8</td> <td>26.0kg</td> </tr> <tr> <td>FR-XCB-22K</td> <td>56.9kg</td> </tr> <tr> <td>FR-XCB-37K</td> <td rowspan="2">350</td> <td rowspan="2">270</td> <td rowspan="2">600</td> <td rowspan="2">575</td> <td rowspan="2">330</td> <td rowspan="2">12</td> <td rowspan="2">M10</td> <td>68.5kg</td> </tr> <tr> <td>FR-XCB-55K</td> <td>68.5kg</td> </tr> </tbody> </table>	Model	W	W1	H	H1	D	d	Screw size	Mass	FR-XCB-18.5K	265	200	470	440	275	10	M8	26.0kg	FR-XCB-22K	56.9kg	FR-XCB-37K	350	270	600	575	330	12	M10	68.5kg	FR-XCB-55K	68.5kg								
	Model	W	W1	H	H1	D	d	Screw size	Mass																																
	FR-XCB-18.5K	265	200	470	440	275	10	M8	26.0kg																																
	FR-XCB-22K								56.9kg																																
	FR-XCB-37K	350	270	600	575	330	12	M10	68.5kg																																
FR-XCB-55K	68.5kg																																								
<p>FR-XCB-H75K</p> 	<p>400 V class (Unit: mm)</p> <table border="1"> <thead> <tr> <th>Model</th> <th>W</th> <th>W1</th> <th>H</th> <th>H1</th> <th>D</th> <th>d</th> <th>Screw size</th> <th>Mass</th> </tr> </thead> <tbody> <tr> <td>FR-XCB-H18.5K</td> <td rowspan="2">265</td> <td rowspan="2">200</td> <td rowspan="2">470</td> <td rowspan="2">440</td> <td rowspan="2">275</td> <td rowspan="2">10</td> <td rowspan="2">M8</td> <td>26.9kg</td> </tr> <tr> <td>FR-XCB-H22K</td> <td>63.0kg</td> </tr> <tr> <td>FR-XCB-H37K</td> <td rowspan="2">350</td> <td rowspan="2">270</td> <td rowspan="2">600</td> <td rowspan="2">575</td> <td rowspan="2">330</td> <td rowspan="2">12</td> <td rowspan="2">M10</td> <td>73.0kg</td> </tr> <tr> <td>FR-XCB-H55K</td> <td>73.0kg</td> </tr> <tr> <td>FR-XCB-H75K</td> <td>240</td> <td>80</td> <td>915</td> <td>885</td> <td>410</td> <td>12</td> <td>M10</td> <td>120.0 kg</td> </tr> </tbody> </table>	Model	W	W1	H	H1	D	d	Screw size	Mass	FR-XCB-H18.5K	265	200	470	440	275	10	M8	26.9kg	FR-XCB-H22K	63.0kg	FR-XCB-H37K	350	270	600	575	330	12	M10	73.0kg	FR-XCB-H55K	73.0kg	FR-XCB-H75K	240	80	915	885	410	12	M10	120.0 kg
Model	W	W1	H	H1	D	d	Screw size	Mass																																	
FR-XCB-H18.5K	265	200	470	440	275	10	M8	26.9kg																																	
FR-XCB-H22K								63.0kg																																	
FR-XCB-H37K	350	270	600	575	330	12	M10	73.0kg																																	
FR-XCB-H55K								73.0kg																																	
FR-XCB-H75K	240	80	915	885	410	12	M10	120.0 kg																																	
<p><<Dedicated contactor box FR-MCB>></p> 	<table border="1"> <thead> <tr> <th>Model</th> <th>Mass</th> </tr> </thead> <tbody> <tr> <td>FR-MCB-H150</td> <td>17.0 kg</td> </tr> </tbody> </table>	Model	Mass	FR-MCB-H150	17.0 kg																																				
Model	Mass																																								
FR-MCB-H150	17.0 kg																																								
<p><<Converter installation enclosure attachment FR-XCCP>></p> 	<p>(Unit: mm)</p> <table border="1"> <thead> <tr> <th>Model</th> <th>W</th> <th>W1</th> <th>H</th> <th>H1</th> <th>D</th> <th>d</th> <th>Screw size</th> </tr> </thead> <tbody> <tr> <td>FR-XCCP01</td> <td>110</td> <td>60</td> <td rowspan="2">330</td> <td rowspan="2">314</td> <td>115</td> <td rowspan="2">6</td> <td rowspan="2">M5</td> </tr> <tr> <td>FR-XCCP02</td> <td>130</td> <td>90</td> <td>120</td> </tr> <tr> <td>FR-XCCP03</td> <td>160</td> <td>120</td> <td>410</td> <td>396</td> <td>116</td> <td>7</td> <td>M6</td> </tr> </tbody> </table>	Model	W	W1	H	H1	D	d	Screw size	FR-XCCP01	110	60	330	314	115	6	M5	FR-XCCP02	130	90	120	FR-XCCP03	160	120	410	396	116	7	M6												
Model	W	W1	H	H1	D	d	Screw size																																		
FR-XCCP01	110	60	330	314	115	6	M5																																		
FR-XCCP02	130	90			120																																				
FR-XCCP03	160	120	410	396	116	7	M6																																		

Name (model)

Specification and structure

A power regeneration converter allows energy generated at braking operation of the inverter to be regenerated to the power supply. Since a converter does not require a discharging resistor necessary like a brake unit, it is effective in space and energy saving and it provides a large peak braking torque.

- Selection method
Select the model according to the applied motor capacity.
- Connection diagram

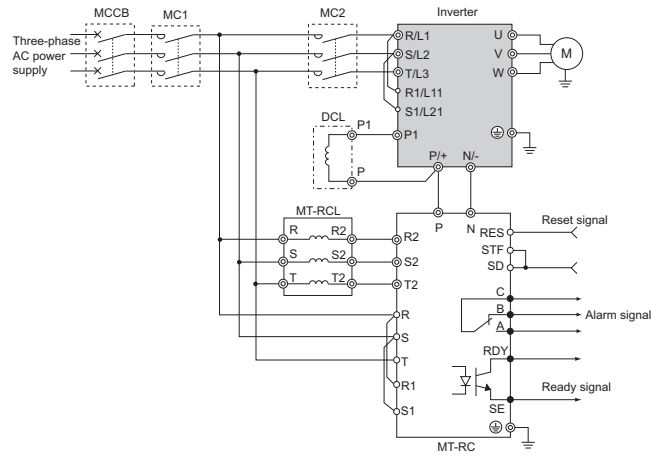

- Outline dimensions (Unit mm)

MT-RC-H75K

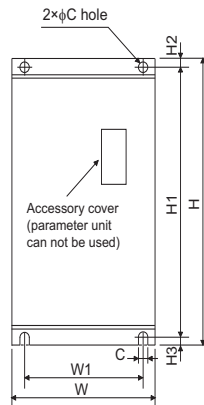

MT-RC-H160K to H280K

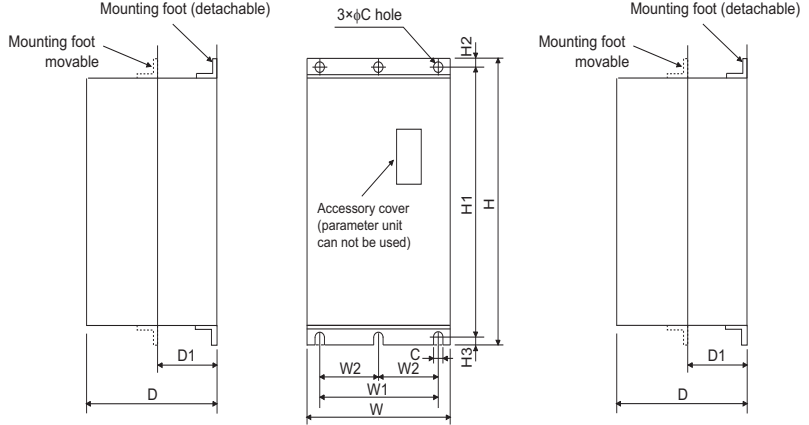

Power regeneration converter
MT-RC-H□K

Model		W	W1	W2	H	H1	H2	H3	D	D1	C
400 V	MT-RC-H75K	480	400	-	740	714	13	13	360	196	10
	MT-RC-H160K	498	400	200	1010	984	13	13	380	196	10
	MT-RC-H220K	680	600	300	1010	984	13	13	380	196	10
	MT-RC-H280K	790	630	315	1330	1300	15	15	440	196	12

MT-RCL

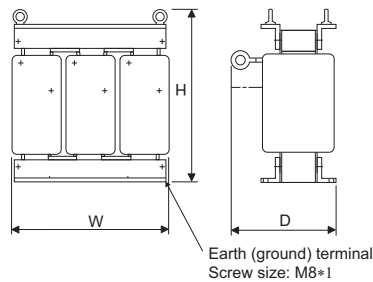

Earth (ground) terminal
Screw size: M8*1

Model		W	H	D
400 V	MT-RCL-H75K	390	385	358
	MT-RCL-H160K	515	465	380
	MT-RCL-H220K	630	655	565
	MT-RCL-H280K	690	690	620

*1 The terminal position differs according to the converter capacity.

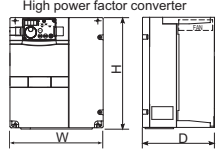
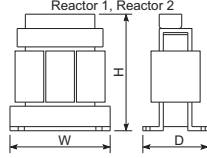
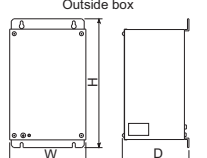
Name (model)	Specification and structure																
<p>High power factor converter FR-HC2- (H)□K</p> 	<p>Substantially suppresses power harmonics to obtain the equivalent capacity conversion coefficient K5 = 0 specified in "the Harmonic Suppression Guidelines for Consumers Who Receive High Voltage or Special High Voltage" in Japan. The power regeneration function comes standard. The common converter driving with several inverters is possible.</p> <ul style="list-style-type: none"> • Selection method Select the model according to capacity of the inverter or the applicable motor, whichever larger. • Specifications 																
	Model: FR-HC2-□ <small>*2</small>	200 V					400 V										
	Applicable inverter capacity (LD rating)*1	7.5K (3.7K) to (7.5K)	15K (7.5K) to (15K)	30K (15K) to (30K)	55K (30K) to (55K)	75K (37K) to (75K)	H7.5K (3.7K) to (7.5K)	H15K (7.5K) to (15K)	H30K (15K) to (30K)	H55K (30K) to (55K)	H75K (37K) to (75K)	H110K (55K) to (110K)	H160K (90K) to (160K)	H220K (110K) to (220K)	H280K (160K) to (280K)	H400K (220K) to (400K)	H560K (280K) to (560K)
	Rated input voltage/frequency	Three-phase 200 V to 220 V 50 Hz 200 V to 230 V 60 Hz					Three-phase 380 V to 460 V 50/60 Hz										
	Rated input current (A)	33	61	115	215	278	17	31	57	110	139	203	290	397	506	716	993
<p>*1 The total capacity of the connected inverters. *2 If a high power factor converter (FR-HC2) is purchased, it comes with reactor 1 (FR-HCL21), reactor 2 (FR-HCL22), and an outside box (FR-HCB2). Do not connect the DC reactor to the inverter when using a high power factor converter. (If an H280K or higher is purchased, it comes with FR-HCL21, FR-HCL22, FR-HCC2, FR-HCR2, and FR-HCM2.)</p> <ul style="list-style-type: none"> • Outline dimension (Unit mm) 																	
Voltage	Capacity	High power factor converter FR-HC2			Reactor 1 FR-HCL21*3			Reactor 2 FR-HCL22*3			Outside box FR-HCB2*4						
		W	H	D	W	H	D	W	H	D	W	H	D				
200 V	7.5K	220	260	170	132	150	100	237.5	230	140	190	320	165				
	15K	250	400	190	162	172	126	257.5	260	165							
	30K	325	550	195	195	210	150	342.5	305	180	270	450	203				
	55K	370	620	250	210	180	200.5	432.5	380	280							
	75K	465	620	300	240	215	215.5	474	460	280				400	450	250	
400 V	H7.5K	220	300	190	132	140	100	237.5	220	140	190	320	165				
	H15K	220	300	190	162	170	126	257.5	260	165							
	H30K	325	550	195	182	195	101	342.5	300	180							
	H55K	370	670	250	282.5	245	165	392.5	365	200	270	450	203				
	H75K	325	620	250	210	175	210.5	430	395	280	300	350	250				
	H110K	465	620	300	240	230	220	500	440	370	350	450	380				
	H160K	498	1010	380	280	295	274.5	560	520	430	400	450	440				
	H220K	498	1010	380	330	335	289.5	620	620	480							
	H280K	680	1010	380	330	335	321	690	700	560				-	-	-	
H400K	790	1330	440	402	460	550	632	675	705	-	-	-					
H560K	790	1330	440	452	545	645	632	720	745	-	-	-					
<div style="display: flex; justify-content: space-around; align-items: flex-start;"> <div style="text-align: center;"> <p>High power factor converter</p>  </div> <div style="text-align: center;"> <p>Reactor 1, Reactor 2</p>  </div> <div style="text-align: center;"> <p>Outside box</p>  </div> </div> <p>*3 Install reactors (FR-HCL21 and 22) on a horizontal surface. *4 The H280K or higher are not equipped with FR-HCB2. A filter capacitor and inrush current limit resistors are provided instead.</p>																	

Name (model)	Specification and structure																																					
Surge voltage suppression filter FR-ASF-H□K	A surge voltage suppression filter limits surge voltage applied to motor terminals when driving the 400 V class motor by the inverter.																																					
	• Selection method Select the model according to the applied motor capacity.																																					
	• Specifications																																					
	Model: FR-ASF-□		400 V																																			
	Applicable motor capacity (kW)		H1.5K	H3.7K	H7.5K	H15K	H22K	H37K	H55K																													
	Rated input current (A)		0.4 to 1.5	2.2 to 3.7	5.5 to 7.5	11 to 15	18.5 to 22	30 to 37	45 to 55																													
	Overload current rating *1		150% 60 s, 200% 0.5 s																																			
	Rated input AC voltage *1		Three-phase 380 V to 460 V 50 Hz/60 Hz																																			
	Maximum AC voltage fluctuation *1		Three-phase 506 V 50 Hz/60 Hz																																			
	Maximum frequency *1		400 Hz																																			
	PWM frequency permissible range		0.5 kHz to 14.5 kHz																																			
	Maximum wiring length between the filter-motor		300 m																																			
	Approx. mass (kg)		8.0	11.0	20.0	28.0	38.0	59.0	78.0																													
	Environment	Surrounding air temperature		-10°C to +50°C (non-freezing)																																		
	Surrounding air humidity		90% RH or less (non-condensing)																																			
Atmosphere		Indoors (without corrosive gas, flammable gas, oil mist, dust and dirt, etc.)																																				
Altitude/vibration		Maximum 1000 m, 5.9 m/s ² or less at 10 to 55 Hz (directions of X, Y, Z axes)																																				
*1 Determined by the specification of the connected inverter (400 V class).																																						
• Connection diagram																																						
• Outline dimension (Unit: mm)																																						
		<table border="1"> <thead> <tr> <th style="background-color: #90EE90;">Model</th> <th style="background-color: #90EE90;">W*1</th> <th style="background-color: #90EE90;">H*1</th> <th style="background-color: #90EE90;">D*1</th> </tr> </thead> <tbody> <tr> <td style="background-color: #90EE90;">FR-ASF-H1.5K</td> <td style="background-color: #90EE90;">221</td> <td style="background-color: #90EE90;">193</td> <td style="background-color: #90EE90;">160</td> </tr> <tr> <td style="background-color: #90EE90;">FR-ASF-H3.7K</td> <td style="background-color: #90EE90;">221</td> <td style="background-color: #90EE90;">200</td> <td style="background-color: #90EE90;">180</td> </tr> <tr> <td style="background-color: #90EE90;">FR-ASF-H7.5K</td> <td style="background-color: #90EE90;">281</td> <td style="background-color: #90EE90;">250</td> <td style="background-color: #90EE90;">215</td> </tr> <tr> <td style="background-color: #90EE90;">FR-ASF-H15K *2</td> <td style="background-color: #90EE90;">336</td> <td style="background-color: #90EE90;">265</td> <td style="background-color: #90EE90;">290</td> </tr> <tr> <td style="background-color: #90EE90;">FR-ASF-H22K *2</td> <td style="background-color: #90EE90;">336</td> <td style="background-color: #90EE90;">345</td> <td style="background-color: #90EE90;">354</td> </tr> <tr> <td style="background-color: #90EE90;">FR-ASF-H37K *2</td> <td style="background-color: #90EE90;">376</td> <td style="background-color: #90EE90;">464</td> <td style="background-color: #90EE90;">429</td> </tr> <tr> <td style="background-color: #90EE90;">FR-ASF-H55K *2</td> <td style="background-color: #90EE90;">396</td> <td style="background-color: #90EE90;">464</td> <td style="background-color: #90EE90;">594</td> </tr> </tbody> </table>					Model	W*1	H*1	D*1	FR-ASF-H1.5K	221	193	160	FR-ASF-H3.7K	221	200	180	FR-ASF-H7.5K	281	250	215	FR-ASF-H15K *2	336	265	290	FR-ASF-H22K *2	336	345	354	FR-ASF-H37K *2	376	464	429	FR-ASF-H55K *2	396	464	594
Model	W*1	H*1	D*1																																			
FR-ASF-H1.5K	221	193	160																																			
FR-ASF-H3.7K	221	200	180																																			
FR-ASF-H7.5K	281	250	215																																			
FR-ASF-H15K *2	336	265	290																																			
FR-ASF-H22K *2	336	345	354																																			
FR-ASF-H37K *2	376	464	429																																			
FR-ASF-H55K *2	396	464	594																																			
*1 This indicates the maximum dimension. *2 The H15K or higher has a different shape.																																						

Name (model)	Specification and structure								
Surge voltage suppression filter FR-BMF-H□K	Limits surge voltage applied to motor terminals when driving a 400 V class motor with an inverter. This filter is compatible with the 5.5 to 37 kW motors.								
	• Selection method								
	Select the model according to the applied motor capacity.								
	• Specifications								
	Model: FR-BMF-H□K	7.5		15		22		37	
	Applicable motor capacity (kW) *1	5.5	7.5	11	15	18.5	22	30	37
	Rated current (A)	17		31		43		71	
	Overload current rating*2	150% 60 s, 200% 0.5 s (inverse-time characteristics)							
	Rated AC input voltage*2	Three-phase 380 to 480 V							
	Permissible AC voltage fluctuation*2	323 to 528 V							
	Maximum frequency*2	120 Hz							
	PWM carrier frequency	2 kHz or lower*3							
	Protective structure (JEM 1030)	Open type (IP00)							
	Cooling system	Self-cooling							
	Maximum wiring length	100 m or lower							
Approx. mass (kg)	5.5	9.5	11.5	19					
Environment	Surrounding air temperature	-10°C to +50°C (non-freezing)							
	Surrounding air humidity	90% RH or less (non-condensing)							
	Atmosphere	Indoors (without corrosive gas, flammable gas, oil mist, dust and dirt, etc.)							
	Altitude/vibration	Maximum 1000 m, 5.9 m/s ² or less*4 at 10 to 55 Hz (directions of X, Y, Z axes)							
*1 Indicates the maximum capacity applicable with the Mitsubishi Electric 4-pole standard motor. (IPM motors are not applicable).									
*2 Determined by the specification of the connected inverter (400 V class).									
*3 Set Pr.72 PWM frequency selection to 2 kHz or less.									
*4 When an inverter has a filter mounted on its back, do not use such an inverter on a moving object or in a place that vibrates (exceeding 1.96 m/s ²).									
• Connection diagram									
• Outline dimension									
FR-BMF-H7.5K		FR-BMF-H15K, H22K			FR-BMF-H37K				

Name (model)	Specification and structure																																																																																																																																					
Sine wave filter MT-BSL-(H)□□K MT-BSC-(H)□□K	<ul style="list-style-type: none"> • Sine wave filter application A sine wave filter can be installed to adjust the motor voltage and current waveforms to be sine waves. Install a sine wave filter to the output side of the inverter. This filter is compatible with the FR-F820-03160(75K) or higher and the FR-F840-01800(75K) or higher. (This product is available only with general-purpose motors.) A sine wave filter will bring operation characteristic equivalent to the operation with a sine wave power supply and also will provide the following benefits. A sine wave filter will bring operation characteristic equivalent to the operation with a sine wave power supply and also will provide the following benefits. <ol style="list-style-type: none"> Low noise No surge current Small motor losses (for a standard motor) • Operating condition The following settings and conditions are required to use a sine wave filter. <ol style="list-style-type: none"> Set "25" in Pr.72. (The initial value is "2".) This setting changes the carrier frequency to 2.5 kHz. (A sine wave filter is designed on the assumption of 2.5 kHz carrier frequency. Always change this setting.) The operation with Pr.72 = "25" setting may damage inverter and the sine wave filter. A sine wave filter can be used for the operation with an inverter output frequency of 60 Hz or lower. It cannot be used for the operation with higher frequency. (Using it with the higher frequency will increase the filter loss.) It is applicable only under V/F control. (When Pr.72 = "25", V/F control is automatically set.) When using the sine wave filter and FR-HC2 together, use MT-BSL-HC. • Circuit configuration and connection 																																																																																																																																					
	<p style="text-align: center;">*Install the filter near the inverter. For a capacitor cable, use a cable with size larger than indicated in the table below "recommended cable size".</p>																																																																																																																																					
	<table border="1"> <thead> <tr> <th rowspan="2">Motor capacity (kW)*1</th> <th colspan="3">Model</th> <th rowspan="2">Applicable inverter</th> </tr> <tr> <th colspan="2">Reactor for filter</th> <th>Capacitor for filter*2</th> </tr> <tr> <th></th> <th></th> <th>Rated current (A)</th> <th></th> <th></th> </tr> </thead> <tbody> <tr> <td rowspan="3">200 V</td> <td>75</td> <td>MT-BSL-75K</td> <td>288</td> <td>1×MT-BSC-75K</td> </tr> <tr> <td>90</td> <td>MT-BSL-90K</td> <td>346</td> <td>1×MT-BSC-90K</td> </tr> <tr> <td>75</td> <td>MT-BSL-H75K(-HC)</td> <td>144</td> <td>1×MT-BSC-H75K</td> </tr> <tr> <td rowspan="7">400 V</td> <td>90</td> <td>MT-BSL-H110K(-HC)</td> <td>216</td> <td>1×MT-BSC-H110K</td> </tr> <tr> <td>110</td> <td>MT-BSL-H110K(-HC)</td> <td>216</td> <td>1×MT-BSC-H110K</td> </tr> <tr> <td>132</td> <td>MT-BSL-H150K(-HC)</td> <td>288</td> <td>2×MT-BSC-H75K</td> </tr> <tr> <td>160</td> <td>MT-BSL-H220K(-HC)</td> <td>432</td> <td>2×MT-BSC-H110K</td> </tr> <tr> <td>185</td> <td>MT-BSL-H220K(-HC)</td> <td>432</td> <td>2×MT-BSC-H110K</td> </tr> <tr> <td>220</td> <td>MT-BSL-H220K(-HC)</td> <td>432</td> <td>2×MT-BSC-H110K</td> </tr> <tr> <td>250</td> <td>MT-BSL-H280K(-HC)</td> <td>576</td> <td>3×MT-BSC-H110K</td> </tr> <tr> <td>280</td> <td>MT-BSL-H280K(-HC)</td> <td>576</td> <td>3×MT-BSC-H110K</td> </tr> </tbody> </table>	Motor capacity (kW)*1	Model			Applicable inverter	Reactor for filter		Capacitor for filter*2			Rated current (A)			200 V	75	MT-BSL-75K	288	1×MT-BSC-75K	90	MT-BSL-90K	346	1×MT-BSC-90K	75	MT-BSL-H75K(-HC)	144	1×MT-BSC-H75K	400 V	90	MT-BSL-H110K(-HC)	216	1×MT-BSC-H110K	110	MT-BSL-H110K(-HC)	216	1×MT-BSC-H110K	132	MT-BSL-H150K(-HC)	288	2×MT-BSC-H75K	160	MT-BSL-H220K(-HC)	432	2×MT-BSC-H110K	185	MT-BSL-H220K(-HC)	432	2×MT-BSC-H110K	220	MT-BSL-H220K(-HC)	432	2×MT-BSC-H110K	250	MT-BSL-H280K(-HC)	576	3×MT-BSC-H110K	280	MT-BSL-H280K(-HC)	576	3×MT-BSC-H110K	<p>*1 Assumes the use of a Mitsubishi Electric standard 4-pole motor.</p> <p>*2 When using two or three capacitors, install them in parallel as shown in the wiring diagram.</p>																																																																									
	Motor capacity (kW)*1		Model				Applicable inverter																																																																																																																															
		Reactor for filter		Capacitor for filter*2																																																																																																																																		
			Rated current (A)																																																																																																																																			
	200 V	75	MT-BSL-75K	288	1×MT-BSC-75K																																																																																																																																	
		90	MT-BSL-90K	346	1×MT-BSC-90K																																																																																																																																	
		75	MT-BSL-H75K(-HC)	144	1×MT-BSC-H75K																																																																																																																																	
	400 V	90	MT-BSL-H110K(-HC)	216	1×MT-BSC-H110K																																																																																																																																	
110		MT-BSL-H110K(-HC)	216	1×MT-BSC-H110K																																																																																																																																		
132		MT-BSL-H150K(-HC)	288	2×MT-BSC-H75K																																																																																																																																		
160		MT-BSL-H220K(-HC)	432	2×MT-BSC-H110K																																																																																																																																		
185		MT-BSL-H220K(-HC)	432	2×MT-BSC-H110K																																																																																																																																		
220		MT-BSL-H220K(-HC)	432	2×MT-BSC-H110K																																																																																																																																		
250		MT-BSL-H280K(-HC)	576	3×MT-BSC-H110K																																																																																																																																		
280	MT-BSL-H280K(-HC)	576	3×MT-BSC-H110K																																																																																																																																			
	<ul style="list-style-type: none"> • Reactor for sine wave filter 																																																																																																																																					
	<p style="text-align: center;">* Remove the eye nut after installation of the product. This is a sample of the outer appearance, which differs depending on the model.</p>																																																																																																																																					
	<table border="1"> <thead> <tr> <th></th> <th>Model</th> <th>A</th> <th>B</th> <th>C</th> <th>D</th> <th>E</th> <th>F</th> <th>G</th> <th>H</th> <th>Mass (kg)</th> </tr> </thead> <tbody> <tr> <td rowspan="3">200 V</td> <td>MT-BSL-75K</td> <td>330</td> <td>150</td> <td>285</td> <td>185</td> <td>216</td> <td>328</td> <td>M10</td> <td>M12</td> <td>80</td> </tr> <tr> <td>MT-BSL-90K</td> <td>390</td> <td>150</td> <td>320</td> <td>180</td> <td>220</td> <td>330</td> <td>M12</td> <td>M12</td> <td>120</td> </tr> <tr> <td>MT-BSL-H75K</td> <td>330</td> <td>150</td> <td>285</td> <td>185</td> <td>216</td> <td>318</td> <td>M10</td> <td>M10</td> <td>80</td> </tr> <tr> <td rowspan="7">400 V</td> <td>MT-BSL-H75K-HC</td> <td>385</td> <td>150</td> <td>345</td> <td>185</td> <td>216</td> <td>315</td> <td>M10</td> <td>M10</td> <td>110</td> </tr> <tr> <td>MT-BSL-H110K</td> <td>390</td> <td>150</td> <td>340</td> <td>195</td> <td>235</td> <td>368</td> <td>M12</td> <td>M12</td> <td>140</td> </tr> <tr> <td>MT-BSL-H110K-HC</td> <td>420</td> <td>170</td> <td>400</td> <td>195</td> <td>235</td> <td>370</td> <td>M12</td> <td>M12</td> <td>180</td> </tr> <tr> <td>MT-BSL-H150K</td> <td>455</td> <td>200</td> <td>397</td> <td>200</td> <td>240</td> <td>380</td> <td>M12</td> <td>M12</td> <td>190</td> </tr> <tr> <td>MT-BSL-H150K-HC</td> <td>450</td> <td>300</td> <td>455</td> <td>390</td> <td>430</td> <td>500</td> <td>M12</td> <td>M12</td> <td>250</td> </tr> <tr> <td>MT-BSL-H220K</td> <td>495</td> <td>200</td> <td>405</td> <td>250</td> <td>300</td> <td>420</td> <td>M12</td> <td>M12</td> <td>240</td> </tr> <tr> <td>MT-BSL-H220K-HC</td> <td>510</td> <td>350</td> <td>540</td> <td>430</td> <td>485</td> <td>555</td> <td>M12</td> <td>M12</td> <td>310</td> </tr> <tr> <td>MT-BSL-H280K</td> <td>575</td> <td>200</td> <td>470</td> <td>310</td> <td>370</td> <td>485</td> <td>M12</td> <td>M12</td> <td>340</td> </tr> <tr> <td>MT-BSL-H280K-HC</td> <td>570</td> <td>400</td> <td>590</td> <td>475</td> <td>535</td> <td>620</td> <td>M12</td> <td>M12</td> <td>480</td> </tr> </tbody> </table> <p style="text-align: center;">Install the reactor on a horizontal surface.</p>		Model	A	B	C	D	E	F	G	H	Mass (kg)	200 V	MT-BSL-75K	330	150	285	185	216	328	M10	M12	80	MT-BSL-90K	390	150	320	180	220	330	M12	M12	120	MT-BSL-H75K	330	150	285	185	216	318	M10	M10	80	400 V	MT-BSL-H75K-HC	385	150	345	185	216	315	M10	M10	110	MT-BSL-H110K	390	150	340	195	235	368	M12	M12	140	MT-BSL-H110K-HC	420	170	400	195	235	370	M12	M12	180	MT-BSL-H150K	455	200	397	200	240	380	M12	M12	190	MT-BSL-H150K-HC	450	300	455	390	430	500	M12	M12	250	MT-BSL-H220K	495	200	405	250	300	420	M12	M12	240	MT-BSL-H220K-HC	510	350	540	430	485	555	M12	M12	310	MT-BSL-H280K	575	200	470	310	370	485	M12	M12	340	MT-BSL-H280K-HC	570	400	590	475	535	620	M12	M12	480
	Model	A	B	C	D	E	F	G	H	Mass (kg)																																																																																																																												
200 V	MT-BSL-75K	330	150	285	185	216	328	M10	M12	80																																																																																																																												
	MT-BSL-90K	390	150	320	180	220	330	M12	M12	120																																																																																																																												
	MT-BSL-H75K	330	150	285	185	216	318	M10	M10	80																																																																																																																												
400 V	MT-BSL-H75K-HC	385	150	345	185	216	315	M10	M10	110																																																																																																																												
	MT-BSL-H110K	390	150	340	195	235	368	M12	M12	140																																																																																																																												
	MT-BSL-H110K-HC	420	170	400	195	235	370	M12	M12	180																																																																																																																												
	MT-BSL-H150K	455	200	397	200	240	380	M12	M12	190																																																																																																																												
	MT-BSL-H150K-HC	450	300	455	390	430	500	M12	M12	250																																																																																																																												
	MT-BSL-H220K	495	200	405	250	300	420	M12	M12	240																																																																																																																												
	MT-BSL-H220K-HC	510	350	540	430	485	555	M12	M12	310																																																																																																																												
MT-BSL-H280K	575	200	470	310	370	485	M12	M12	340																																																																																																																													
MT-BSL-H280K-HC	570	400	590	475	535	620	M12	M12	480																																																																																																																													
	<ul style="list-style-type: none"> • Capacitor for sine wave filter 																																																																																																																																					
	<table border="1"> <thead> <tr> <th></th> <th>Model</th> <th>A</th> <th>B</th> <th>C</th> <th>D</th> <th>E</th> <th>F</th> <th>G</th> <th>H</th> <th>I</th> <th>Mass (kg)</th> </tr> </thead> <tbody> <tr> <td rowspan="2">200 V</td> <td>MT-BSC-75K</td> <td>207</td> <td>191</td> <td>285</td> <td>233</td> <td>72</td> <td>41</td> <td>45</td> <td>φ7</td> <td>M8</td> <td>3.9</td> </tr> <tr> <td>MT-BSC-90K</td> <td>282</td> <td>266</td> <td>240</td> <td>183</td> <td>92</td> <td>56</td> <td>85</td> <td>φ7</td> <td>M12</td> <td>5.5</td> </tr> <tr> <td rowspan="2">400 V</td> <td>MT-BSC-H75K</td> <td>207</td> <td>191</td> <td>220</td> <td>173</td> <td>72</td> <td>41</td> <td>55</td> <td>φ7</td> <td>M6</td> <td>3.0</td> </tr> <tr> <td>MT-BSC-H110K</td> <td>207</td> <td>191</td> <td>280</td> <td>233</td> <td>72</td> <td>41</td> <td>55</td> <td>φ7</td> <td>M6</td> <td>4.0</td> </tr> </tbody> </table>		Model	A	B	C	D	E	F	G	H	I	Mass (kg)	200 V	MT-BSC-75K	207	191	285	233	72	41	45	φ7	M8	3.9	MT-BSC-90K	282	266	240	183	92	56	85	φ7	M12	5.5	400 V	MT-BSC-H75K	207	191	220	173	72	41	55	φ7	M6	3.0	MT-BSC-H110K	207	191	280	233	72	41	55	φ7	M6	4.0																																																																											
	Model	A	B	C	D	E	F	G	H	I	Mass (kg)																																																																																																																											
200 V	MT-BSC-75K	207	191	285	233	72	41	45	φ7	M8	3.9																																																																																																																											
	MT-BSC-90K	282	266	240	183	92	56	85	φ7	M12	5.5																																																																																																																											
400 V	MT-BSC-H75K	207	191	220	173	72	41	55	φ7	M6	3.0																																																																																																																											
	MT-BSC-H110K	207	191	280	233	72	41	55	φ7	M6	4.0																																																																																																																											
	<ul style="list-style-type: none"> When installing, allow 25 mm or more gap between capacitors. • Recommended cable gauge The gauge of the cables used between inverter and MT-BSL as well as MT-BSL and induction motor varies according to U, V, and W as indicated on page 115. The following table shows the cable gauge of the MT-BSC connecting cable. 																																																																																																																																					
	<table border="1"> <thead> <tr> <th>MT-BSC-75K</th> <th>MT-BSC-90K</th> <th>MT-BSC-H75K</th> <th>MT-BSC-H110K</th> </tr> </thead> <tbody> <tr> <td>38 mm²</td> <td>38 mm²</td> <td>22 mm²</td> <td>22 mm²</td> </tr> </tbody> </table>	MT-BSC-75K	MT-BSC-90K	MT-BSC-H75K	MT-BSC-H110K	38 mm ²	38 mm ²	22 mm ²	22 mm ²																																																																																																																													
MT-BSC-75K	MT-BSC-90K	MT-BSC-H75K	MT-BSC-H110K																																																																																																																																			
38 mm ²	38 mm ²	22 mm ²	22 mm ²																																																																																																																																			

Low-Voltage Switchgear/Cables

Mitsubishi Electric Molded Case Circuit Breakers and Earth Leakage Circuit Breakers WS-V Series

Our main series of products in the industry's smallest class with high breaking capability enabled by a new breaking technology.

The new WS-V series breaker has enhanced usability by further standardizing internal parts, meets international standards, and addresses environmental and energy-saving issues.

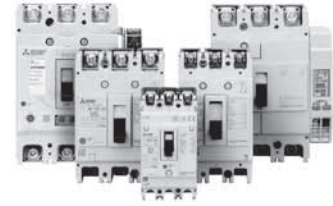

◆ Features

◆ A 54-mm-wide body, which belongs to the smallest class in the industry

The compact body allows for downsizing of the equipment and enclosure.

The breakers have been downsized to 54 mm wide and 52 mm depth (decreased by 16 mm compared with S-class general-purpose products).

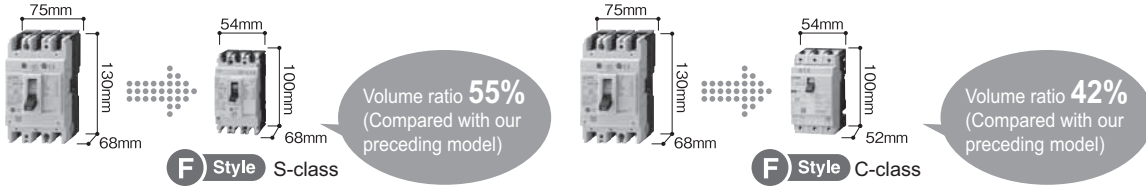

When multiple units are used, the width becomes significantly smaller.

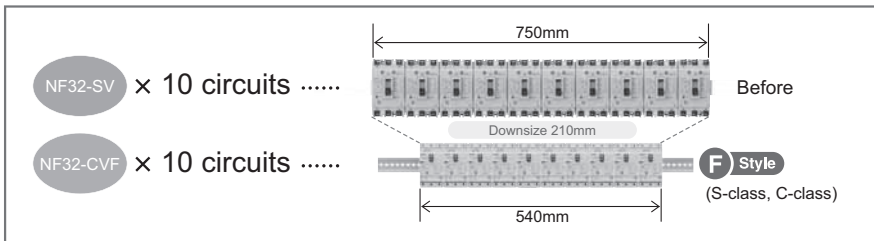

◆ Conforms to various global standards

- New JIS standard: JIS C 8201-2-1 (NF) Annex 1 and Annex 2
- Electrical Appliances and Materials Safety Act (PSE)
- IEC standard: IEC 60947-2
- EN (Europe): EN 60947-2, CE marking (TÜV certification, self declaration)
- GB standard (China): GB/T 14048.2 CCC certification
- Safety certification (Korea): KC marking



◆ Three-phase power supply supported by CE/CCC marked earth leakage circuit breakers

GB/T 14048.2-2008 was established in China, requiring the earth leakage circuit breaker to fulfill its function even if a phase is lost as is the case with the EN standard in Europe. CE/CCC marked earth leakage circuit breakers of the WS-V series support three phase power supply. Compliance with the revised standard is certified.

◆ Lineup of UL 489 listed circuit breakers with 54 mm width "Small Fit" (F Style)

The compact breakers contribute to a size reduction of machines, and IEC 35 mm rail mounting is standard.

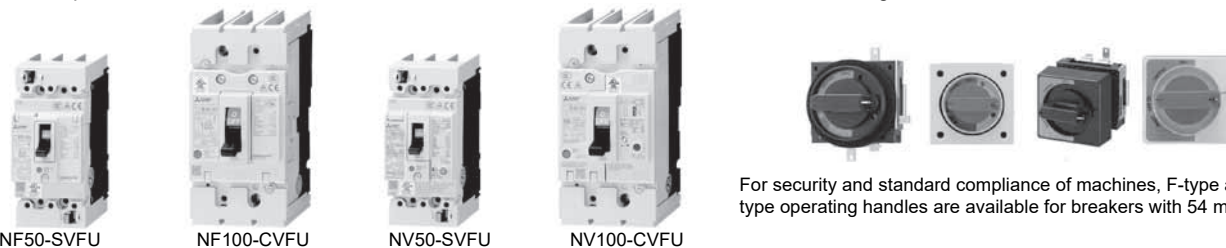

For security and standard compliance of machines, F-type and V-type operating handles are available for breakers with 54 mm width.

◆ Lineup of UL 489 listed circuit breakers for 480 V AC "High Performance"

The breaking capacity has been improved to satisfy the request for SCCR upgrading.

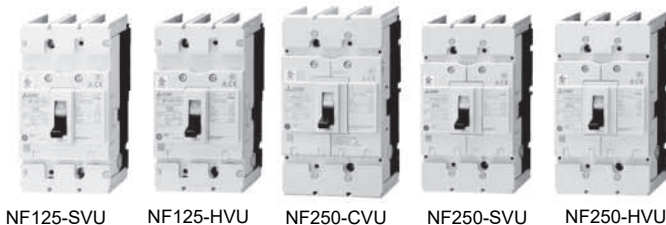

Breaking capacity of UL 489 listed circuit breakers for 480 V AC (UL 489) (Example of 240 V AC)

NF125-SVU/NV125-SVU	50 kA
NF125-HVU/NV125-HVU	100 kA
NF250-CVU/NV250-CVU	35 kA
NF250-SVU/NV250-SVU	65 kA
NF250-HVU/NV250-HVU	100 kA

● Mitsubishi Electric Magnetic Motor Starters and Magnetic Contactors MS-T Series

Mitsubishi Electric magnetic motor starters have been newly designed and the MS-T series has been released. The MS-T series is smaller than ever, enabling more compact control panel. The MS-T series is suitable for other Mitsubishi Electric FA equipment. In addition, the MS-T conforms to a variety of global standards, supporting the global use.



S-T10







◆ Features

◆ Compact

General-purpose magnetic contactor with smallest width*1 in the industry. The width of MS-T series is reduced by 32% as compared to the prior MS-N series, enabling a more compact panel. For selection, refer to **page 115**.

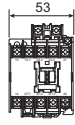
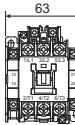
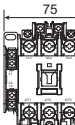
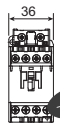
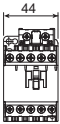
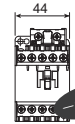
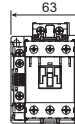
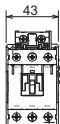
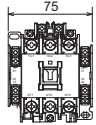
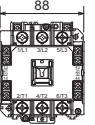
*1 For 10 A frame class general-purpose magnetic contactor (according to our investigation as of November 2020)

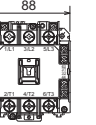
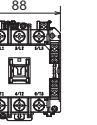
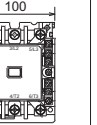
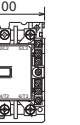
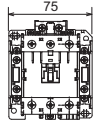
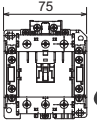
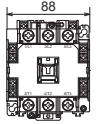
[Unit: mm].

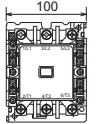
Frame size	11A	13A		20A	25A	32A		
MS-N series	 S-N10	 S-N11 (Auxiliary 1-pole)	 S-N12 (Auxiliary 2-pole)	 S-N20	 S-N25	None		
New MS-T series	 S-T10	 S-T12 (Auxiliary 2-pole)		 S-T20	 S-T25	 S-T32		
Frame size	35A		50A		65A		80A	100A
MS-N series	 S-N35	 S-N50	 S-N50AE	 S-N65	 S-N65AE	 S-N80	 S-N95	
New MS-T series	 S-T35	 S-T50		 S-T65	 S-T80	 S-T100		

◆ Standardization

- Terminal covers are provided as standard to ensure safety inside the enclosure. Users do not have to make arrangements to specify and obtain options separately. Covers are provided also for the auxiliary contact unit. Users can reduce their inventory.
- Widened range of operation coil ratings (AC operated model) The widened range reduces the number of operation coil rating types from 13 (MS-N series) to 7. The reduced number of the operation coil types enables more simplified customers' ordering process and the faster delivery.
- Customers can select the operation coil more easily.

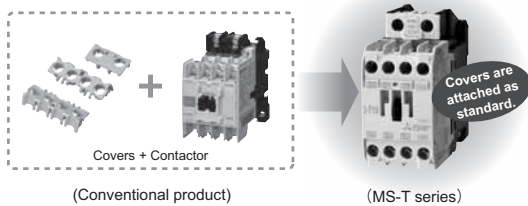

Coil designation	Rated voltage [V]	
	50 Hz	60 Hz
24 VAC	24	24
48 VAC	48 to 50	48 to 50
100 VAC	100	100 to 110
120 VAC	110 to 120	115 to 120
127 VAC	125 to 127	127
200 VAC	200	200 to 220
220 VAC	208 to 220	220
230 VAC	220 to 240	230 to 240
260 VAC	240 to 260	260 to 280
380 VAC	346 to 380	380
400 VAC	380 to 415	400 to 440
440 VAC	415 ~ 440	460 to 480
500 VAC	500	500 to 550





Coil designation	Rated voltage [V]	
	50 Hz/60 Hz	
24 VAC	24	
48 VAC	48 to 50	
100 VAC	100 to 127	
200 VAC	200 to 240	
300 VAC	260 to 300	
400 VAC	380 to 440	
500 VAC	460 to 550	

*Seven types are available without change for the 50 A frame model or higher.



◆ Global Standard

- Conforms to various global standards Our magnetic contactors are certified as compliant not only with major international standards such as IEC, JIS, UL, CE, and CCC but also with ship classification standards and country specific standards. This will help our customers expand their business overseas.

Standard	Applicable standard				Safety standard
	International	Japan	Europe	China	U.S.A./ Canada
	IEC*2	JIS	EN	Certification body	GB
			EC Directive		
					

*2 Compliant with the requirements for mirror contacts in standards such as IEC 60947-4-1, and TÜV-certified.

● Spring Clamp Terminal Models Available for Mitsubishi Electric Magnetic Contactor and Magnetic Relay

Spring clamp terminal:

Easy-to-connect terminal that ensures connection with the contact pressure of the spring just by pushing wire into the conductive terminal. Solid wires and ferrules can be connected simply by inserting them into the terminals.

Stranded wires can be connected by opening the spring with a tool, inserting wire, and removing the tool.



◆ Features

Key features of the screwless terminals:

- Significant reduction in the time required for wiring
Comparison with the terminal screw model (with round crimp terminal)
Wiring with ferrules: 22% reduction
Wiring with solid or stranded wire: 52% reduction
Reduction in the time required for wiring
Wiring performed by non-experts (with 2-year experience) (The research conducted by Japan Switchboard & control system Industries Association)
- Easy wiring for whoever works on
Push-in connection eliminates the need for the screw-tightening skills.
- Enhanced maintenance efficiency
Screw retightening is not necessary for installation and maintenance of enclosures and machines.
- Reliable wire connection
There is no risk of terminal screw loosening due to vibration or shocks, or long-term service.

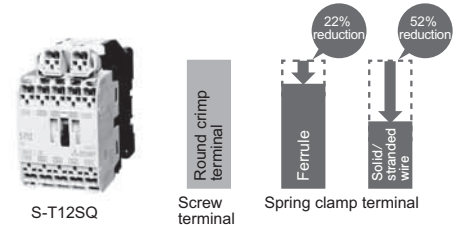

● Motor Circuit Breaker MMP-T Series

Motor circuit protection (against overload / phase loss / short-circuit) is achievable the MMP-T series alone.

The wire-saving, space-saving design enables downsizing of the enclosure.

The MMP-T series can be used in combination with the MS-T series.



MMP-T32

◆ Features

◆ What is the motor circuit breaker?

The motor circuit breaker, applicable to the motor circuit, has the functions of a circuit breaker and a thermal overload relay in one unit. The motor circuit breaker provides protection against overload, phase loss, and short circuit.

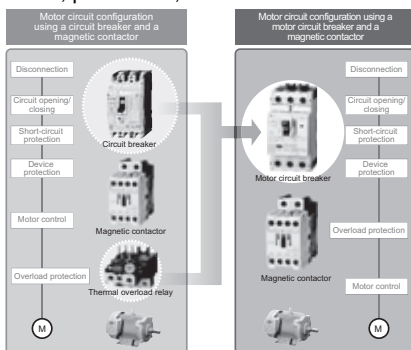

◆ Wire saving

Using a connection conductor unit (option) for connecting a motor circuit breaker and a contactor reduces work hours required for wiring. A connection conductor unit for the high sensitivity contactor (SD-Q) is also available. (Model: UT-MQ12)

◆ Space-saving design for downsizing of the enclosure

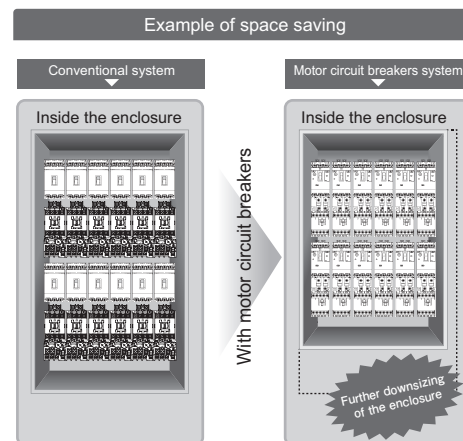

Example of wire saving

Conductor unit connection example

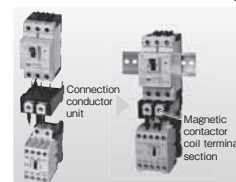

UT-MQ12 application example

● Selecting the rated sensitivity current for the earth leakage circuit breaker

When using an earth leakage circuit breaker with the inverter circuit, select its rated sensitivity current as follows, independently of the PWM carrier frequency.

- Breaker designed for harmonic and surge suppression
Rated sensitivity current
 $I_{\Delta n} \geq 10 \times (I_{g1} + I_{gn} + I_{gi} + I_{g2} + I_{gm})$
- Standard breaker
Rated sensitivity current
 $I_{\Delta n} \geq 10 \times \{I_{g1} + I_{gn} + I_{gi} + 3 \times (I_{g2} + I_{gm})\}$
I_{g1}, I_{g2}: Leakage currents in wire path during commercial power supply operation
I_{gn}: Leakage current of inverter input side noise filter
I_{gm}: Leakage current of motor during commercial power supply operation
I_{gi}: Leakage current of inverter unit

<Example>

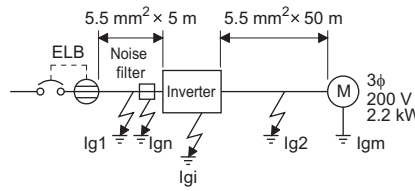

- Install the earth leakage circuit breaker (ELB) on the input side of the inverter.
- In the Δ connection earthed-neutral system, the sensitivity current is blunt against a ground fault in the inverter output side. Earthing (Grounding) must conform to the requirements of national and local safety regulations and electrical codes. (NEC section 250, IEC 536 class 1 and other applicable standards)

◆ Selection example (in the case of the above figure)

	Breaker designed for harmonic and surge suppression	Standard breaker
Leakage current I _{g1} (mA)	$33 \times \frac{5 \text{ m}}{1000 \text{ m}} = 0.17$	
Leakage current I _{gn} (mA)	0 (without noise filter)	
Leakage current I _{gi} (mA)	1 (without EMC filter) Refer to the following table for the leakage current of the inverter.*1	
Leakage current I _{g2} (mA)	$33 \times \frac{50 \text{ m}}{1000 \text{ m}} = 1.65$	
Motor leakage current I _{gm} (mA)	0.18	
Total leakage current (mA)	3.00	6.66
Rated sensitivity current (mA) (≥ I _g × 10)	30	100

*1 For whether to use the EMC filter or not, refer to the Instruction Manual (Detailed).

Example of leakage current of cable path per 1km during the commercial power supply operation when the CV cable is routed in metal conduit (200 V 60 Hz)

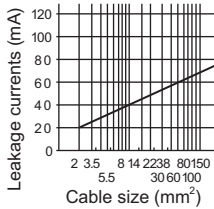

Leakage current example of three-phase induction motor during the commercial power supply operation (200 V 60 Hz)

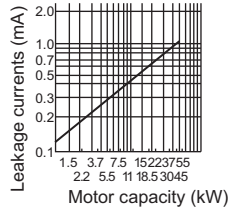

Example of leakage current per 1km during the commercial power supply operation when the CV cable is routed in metal conduit

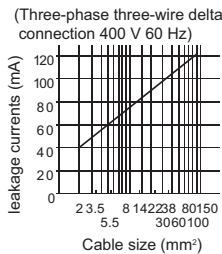

Leakage current example of three-phase induction motor during the commercial power supply operation

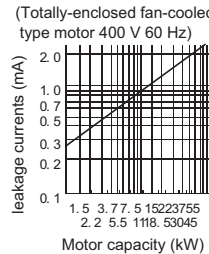

For Δ connection, the amount of leakage current is approx. 1/3 of the above value.

◆ Inverter/converter unit leakage current

200 V class (Input power supply conditions: 220 V / 60 Hz, power supply unbalance: within 3%)

Inverter	FR-F800 (Standard model)	
	EMC filter ON	OFF
Phase earthing (grounding)	22	1

(mA)

400 V class (Input power supply conditions: 440 V / 60 Hz, power supply unbalance: within 3%)

Inverter/converter unit	FR-F800 (Standard model)		FR-F802 (Separated converter type)	Converter unit FR-CC2	
	EMC filter ON	OFF	—	ON	OFF
Phase earthing (grounding)	35	2	2	70	2
Earthed-neutral system	2	1	1	2	1

(mA)

● Molded case circuit breaker, magnetic contactor, cable gauge

◆ 315K or lower

Voltage	Motor output (kW) ^{*1}	Applicable inverter model (LD rating)	Molded case circuit breaker (MCCB) ^{*2} or earth leakage circuit breaker (ELB) (NF, NV type)		Input side magnetic contactor ^{*3}		Recommended Cable gauge (mm ²) ^{*4}		U, V, W
			Power factor improving (AC or DC) reactor connection		Power factor improving (AC or DC) reactor connection		R/L1, S/L2, T/L3		
			Without	With	Without	With	Without	With	
200 V class	0.75	FR-F820-00046(0.75K)	10 A	10 A	S-T10	S-T10	2	2	2
	1.5	FR-F820-00077(1.5K)	15 A	15 A	S-T10	S-T10	2	2	2
	2.2	FR-F820-00105(2.2K)	20 A	15 A	S-T10	S-T10	2	2	2
	3.7	FR-F820-00167(3.7K)	30 A	30 A	S-T21	S-T10	3.5	3.5	3.5
	5.5	FR-F820-00250(5.5K)	50 A	40 A	S-T25	S-T21	5.5	5.5	5.5
	7.5	FR-F820-00340(7.5K)	60 A	50 A	S-T35	S-T25	8	5.5	5.5
	11	FR-F820-00490(11K)	75 A	75 A	S-T35	S-T35	14	14	14
	15	FR-F820-00630(15K)	125 A	100 A	S-T50	S-T50	22	22	22
	18.5	FR-F820-00770(18.5K)	150 A	125 A	S-T65	S-T50	38	22	22
	22	FR-F820-00930(22K)	175 A	125 A	S-T100	S-T65	38	38	38
	30	FR-F820-01250(30K)	225 A	150 A	S-T100	S-T100	60	60	60
	37	FR-F820-01540(37K)	250 A	200 A	S-N150	S-N125	80	60	60
	45	FR-F820-01870(45K)	300 A	225 A	S-N180	S-N150	100	100	100
	55	FR-F820-02330(55K)	400 A	300 A	S-N220	S-N180	100	100	100
400 V class	75	FR-F820-03160(75K)	-	400 A	-	S-N300	-	125	125
	90	FR-F820-03800(90K)	-	400 A	-	S-N300	-	150	150
	110	FR-F820-04750(110K)	-	500 A	-	S-N400	-	150	150
	0.75	FR-F840-00023(0.75K)	5 A	5 A	S-T10	S-T10	2	2	2
	1.5	FR-F840-00038(1.5K)	10 A	10 A	S-T10	S-T10	2	2	2
	2.2	FR-F840-00052(2.2K)	10 A	10 A	S-T10	S-T10	2	2	2
	3.7	FR-F840-00083(3.7K)	20 A	15 A	S-T10	S-T10	2	2	2
	5.5	FR-F840-00126(5.5K)	30 A	20 A	S-T21	S-T12	2	2	2
	7.5	FR-F840-00170(7.5K)	30 A	30 A	S-T21	S-T21	3.5	3.5	3.5
	11	FR-F840-00250(11K)	50 A	40 A	S-T21	S-T21	5.5	5.5	5.5
	15	FR-F840-00310(15K)	60 A	50 A	S-T35	S-T21	8	5.5	5.5
	18.5	FR-F840-00380(18.5K)	75 A	60 A	S-T35	S-T35	14	8	8
	22	FR-F840-00470(22K)	100 A	75 A	S-T35	S-T35	14	14	14
	30	FR-F840-00620(30K)	125 A	100 A	S-T50	S-T50	22	22	22
	37	FR-F840-00770(37K)	150 A	100 A	S-T65	S-T50	22	22	22
	45	FR-F840-00930(45K)	175 A	125 A	S-T100	S-T65	38	38	38
	55	FR-F840-01160(55K)	200 A	150 A	S-T100	S-T100	60	60	60
	75	FR-F840-01800(75K)	-	200 A	-	S-T100	-	60	60
90	FR-F840-02160(90K)	-	225 A	-	S-N150	-	60	60	
110	FR-F840-02600(110K)	-	225 A	-	S-N180	-	80	80	
132	FR-F840-03250(132K)	-	350 A	-	S-N220	-	100	100	
150	FR-F840-03610(160K)	-	400 A	-	S-N300	-	125	150	
160	FR-F840-03610(160K)	-	400 A	-	S-N300	-	125	150	
185	FR-F840-04320(185K)	-	400 A	-	S-N300	-	150	150	
220	FR-F840-04810(220K)	-	500 A	-	S-N400	-	2×100	2×100	
250	FR-F840-05470(250K)	-	600 A	-	S-N600	-	2×100	2×100	
280	FR-F840-06100(280K)	-	600 A	-	S-N600	-	2×125	2×125	
315	FR-F840-06830(315K)	-	700 A	-	S-N600	-	2×150	2×150	

*1 Assumes the use of an IPM motor MM-EFS, MM-THE4 or a Mitsubishi Electric 4-pole standard motor with the motor capacity of 200 VAC 50 Hz.

*2 Select an MCCB according to the power supply capacity. Install one MCCB per inverter.

(For use in the United States or Canada, refer to "Instructions for UL and cUL" in the Instruction Manual (Startup).)

*3 The magnetic contactor is selected based on the AC-1 class. The electrical durability of magnetic contactor is 500,000 times. When the magnetic contactor is used for emergency stops during motor driving, the electrical durability is 25 times.

If using an MC for emergency stop during motor driving or using it on the motor side during commercial power supply operation, select an MC with the class AC-3 rated current for the rated motor current.

*4 Cables

For FR-F820-02330(55K) or lower and FR-F840-01160(55K) or lower, it is the gauge of a cable with the continuous maximum permissible temperature of 75°C. (HIV cable (600 V grade heat-resistant PVC insulated wire), etc.) It assumes a surrounding air temperature of 50°C or lower and the wiring distance of 20 m or shorter.

For FR-F820-03160(75K) or higher and FR-F840-01800(75K) or higher, it is the gauge of the cable with the continuous maximum permissible temperature of 90°C or higher. (LMFC (heat resistant flexible cross-linked polyethylene insulated cable), etc.) It assumes a surrounding air temperature of 50°C or lower and in-enclosure wiring.

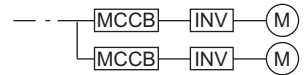

NOTE

- When the inverter capacity is larger than the motor capacity, select an MCCB and a magnetic contactor according to the inverter model, and select cables and reactors according to the motor output.
- When the breaker on the inverter's input side trips, check for the wiring fault (short circuit), damage to internal parts of the inverter etc. The cause of the trip must be identified and removed before turning ON the power of the breaker.

◆ 355K or higher

Voltage	Motor output (kW) ^{*1}	Applicable inverter model (LD rating)	Applicable converter model	Molded case circuit breaker (MCCB) ^{*2} or earth leakage circuit breaker (ELB) (NF, NV type)	Input-side magnetic contactor ^{*3}	HIV cables, etc. (mm ²) ^{*4}		
						R/L1, S/L2, T/L3	P/+, N/-	U, V, W
400 V class	355	FR-F842-07700(355K)	FR-CC2-H355K	800 A	S-N600	2×200	2×200	2×200
	400	FR-F842-08660(400K)	FR-CC2-H400K	900 A	S-N800	2×200	2×200	2×200
	450	FR-F842-09620(450K)	FR-CC2-H450K	1000 A	1000 A rated product	2×250	2×250	2×250
	500	FR-F842-10940(500K)	FR-CC2-H500K	1200 A	1000 A rated product	3×200	3×200	2×250
	560	FR-F842-12120(560K)	FR-CC2-H560K	1500 A	1200 A rated product	3×200	3×200	3×200
	630	FR-F842-12120(560K) ^{*5}	FR-CC2-H630K	2000 A	1400 A rated product	3×200	3×200	3×200

*1 Assumes the use of a Mitsubishi Electric 4-pole standard motor with the motor capacity of 400 VAC 50 Hz.

*2 Select an MCCB according to the power supply capacity. Install one MCCB per converter.
(For use in the United States or Canada, refer to "Instructions for UL and cUL" in the Instruction Manual (Hardware).)

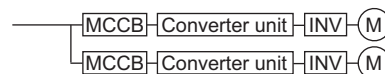

*3 The magnetic contactor is selected based on the AC-1 class. The electrical durability of magnetic contactor is 500,000 times. When the magnetic contactor is used for emergency stops during motor driving, the electrical durability is 25 times. If using an MC for emergency stop during driving the motor, select an MC regarding the converter unit input side current as JEM1038-AC-3 class rated current. When using an MC on the inverter output side for commercial-power supply operation switching using a general-purpose motor, select an MC regarding the rated motor current as JEM1038-AC-3 class rated current.

*4 The gauge of the cable with the continuous maximum permissible temperature of 90°C or higher. (LMFC (heat resistant flexible cross-linked polyethylene insulated cable), etc.). It assumes a surrounding air temperature of 40°C or lower and in-enclosure wiring.

*5 This can be used when the SLD rating is selected for the FR-F842-12120(560K).

NOTE

- When the converter unit capacity is larger than the motor capacity, select an MCCB and a magnetic contactor according to the converter unit model, and select cables and reactors according to the motor output.
- When the breaker on the converter unit's input side trips, check for the wiring fault (short circuit), damage to internal parts of the inverter and the converter unit, etc. The cause of the trip must be identified and removed before turning ON the power of the breaker.

Precaution on Selection and Operation

● Precautions for use

◆ ⚠ Safety instructions

- To use the product safely and correctly, make sure to read the "Instruction Manual" before the use.
- This product has not been designed or manufactured for use with any equipment or system operated under life-threatening conditions.
- Please contact our sales representative when considering using this product in special applications such as passenger mobile, medical, aerospace, nuclear, power or undersea relay equipment or system.
- Although this product was manufactured under conditions of strict quality control, install safety devices to prevent serious accidents when it is used in facilities where breakdowns of the product or other failures are likely to cause a serious accident.
- Do not use the inverter for a load other than the three-phase induction motor and the PM motor.
- Do not connect a PM motor in the induction motor control settings (initial settings). Do not use an induction motor in the PM motor control settings. It will cause a failure.
- When using an IPM motor (MM-EFS, MM-THE4), also refer to the precautions for use of the IPM motors (MM-EFS, MM-THE4).

◆ Operation

- When a magnetic contactor (MC) is installed on the input side, do not use the MC for frequent starting/stopping. Otherwise the inverter may be damaged.
- When a fault occurs in the inverter, the protective function is activated to stop the inverter output. However, the motor cannot be immediately stopped. For machinery and equipment that require an immediate stop, provide a mechanical stop/holding mechanism.
- Even after turning OFF the inverter/the converter unit, it takes time to discharge the capacitor. Before performing an inspection, wait 10 minutes or longer after the power supply turns OFF, then check the voltage using a tester, etc.
- To maintain the security (confidentiality, integrity, and availability) of the inverter and the system against unauthorized access, DoS*1 attacks, computer viruses, and other cyberattacks from external devices via network, take appropriate measures such as firewalls, virtual private networks (VPNs), and antivirus solutions. We shall have no responsibility or liability for any problems involving inverter trouble and system trouble by DoS attacks, unauthorized access, computer viruses, and other cyberattacks.
 - *1 DoS: A denial-of-service (DoS) attack disrupts services by overloading systems or exploiting vulnerabilities, resulting in a denial-of-service (DoS) state.
- When the emergency drive operation is performed, the operation is continued or the retry is repeated even when a fault occurs, which may damage or burn the inverter and motor. Before restarting the normal operation after using this function, make sure that the inverter and motor have no fault.

◆ Wiring

- Applying the power to the inverter output terminals (U, V, W) causes a damage to the inverter. Before power-on, thoroughly check the wiring and sequence to prevent incorrect wiring, etc.
- Terminals P/+, P1, and N/- are the terminals to connect dedicated options or DC power supply (in the DC feeding mode). Do not connect any device other than the dedicated options or DC power supply (in the DC feeding mode). Do not short-circuit between the frequency setting power supply terminal 10 and the common terminal 5, and between the terminals PC and SD.
- To prevent a malfunction due to noise, keep the signal cables 10cm or more away from the power cables. Also, separate the main circuit cables at the input side from the main circuit cables at the output side.
- After wiring, wire offcuts must not be left in the inverter/the converter unit. Wire offcuts can cause an alarm, failure or malfunction. Always keep the inverter/the converter unit clean. When drilling mounting holes in an enclosure etc., take caution not to allow chips and other foreign matter to enter the inverter/the converter unit.
- Set the voltage/current input switch correctly. Incorrect setting may cause a fault, failure or malfunction.

◆ Power supply

- When the inverter is connected near a large-capacity power transformer (1000 kVA or more) or when a power factor correction capacitor is to be switched over, an excessive peak current may flow in the power input circuit, damaging the inverter. To prevent this, always install an optional AC reactor (FR-HAL).
- If surge voltage occurs in the power supply system, this surge energy may flow into an inverter, and the inverter may display the overvoltage protection (E. OV[]) and trip. To prevent this, install an optional AC reactor (FR-HAL).

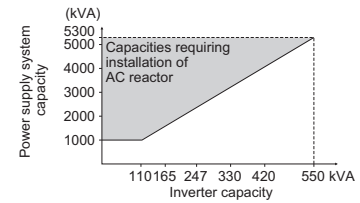

◆ Installation

- Install the inverter in a clean place with no floating oil mist, cotton fly, dust and dirt, etc. Alternatively, install the inverter inside the "sealed type" enclosure that prevents entry of suspended substances. For installation in the enclosure, decide the cooling method and the enclosure size to keep the surrounding air temperature of the inverter/the converter unit within the permissible range (for specifications, refer to **page 21**).
- Some parts of the inverter/the converter unit become extremely hot. Do not install the inverter/the converter unit to inflammable materials (wood etc.).
- Attach the inverter vertically.

◆ Setting

- Depending on the parameter setting, high-speed operation (up to 590 Hz) is available. Incorrect setting will lead to a dangerous situation. Set the upper limit by using the upper frequency limit setting.
- Setting the DC injection brake operation voltage and operating time larger than their initial values causes motor overheating (electronic thermal O/L relay trip).

◆ Waterproof and dustproof performances (IP55 compatible model)

- The inverter is rated with an IPX5*1 waterproof rating and an IP5X*2 dustproof rating when the operation panel (FR-DU08-01), the front cover, the wiring cover, and the cable glands are securely fixed with screws.
- The items enclosed with the inverter such as the Instruction Manual or CD are not rated with the IPX5 waterproof or IP5X dustproof ratings.
- Although the inverter is rated with the IPX5 waterproof and IP5X dustproof ratings, it is not intended for use in water. Also, the ratings do not guarantee protection of the inverter from needless submersion in water or being washed under strong running water such as a shower.
- Do not pour or apply the following liquids over the inverter: water containing soap, detergent, or bath additives; sea water; swimming pool water; warm water; boiling water; etc.
- The inverter is intended for indoor*4 installation and not for outdoor installation. Avoid places where the inverter is subjected to direct sunlight, rain, sleet, snow, or freezing temperatures.
- If the operation panel (FR-DU08-01) is not installed, if the screws of the operation panel are not tightened, or if the operation panel is damaged or deformed, the IPX5 waterproof performance and the IP5X dustproof performance are impaired. If any abnormalities are found on the operation panel, ask for an inspection and repair.
- If the screws of the front cover or the wiring cover are not tightened, if any foreign matter (hair, sand grain, fiber, etc.) is stuck between the inverter and the gasket, if the gasket is damaged, or if the front cover or the wiring cover is damaged or deformed, the IPX5 waterproof performance and the IP5X dustproof performance are impaired. If any abnormalities are found on the front cover, wiring cover, or the gasket of the inverter, ask for an inspection and repair.
- Cable glands are important components to maintain the waterproof and dustproof performances. Be sure to use cable glands of the recommended size and shape or equivalent. The standard protective bushes cannot sufficiently maintain the IPX5 waterproof performance and the IP5X dustproof performance.
- If a cable gland is damaged or deformed, the IPX5 waterproof performance and the IP5X dustproof performance are impaired. If any abnormalities are found on the cable glands, ask the manufacturer of the cable glands for an inspection and repair.
- To maintain the waterproof and dustproof performances of the inverter, daily and periodic inspections are recommended regardless of the presence or absence of abnormalities.

*1 IPX5 refers to protection of the inverter functions against water jets from any direction when about 12.5-liter water*3 is injected from a nozzle with an inside diameter of 6.3 mm from the distance of about 3 m for at least 3 minutes.

*2 IP5X refers to protection of the inverter functions and maintenance of safety when the inverter is put into a stirring device containing dust of 75 μm or smaller in diameter, stirred for 8 hours, and then removed from the device.

*3 Water here refers to fresh water at room temperature (5 to 35°C).

*4 Indoor here refers to the environments that are not affected by climate conditions.

● Precautions for use of IPM motor (MM-EFS, MM-THE4)

When using the IPM motor (MM-EFS, MM-THE4), the following precautions must be observed as well.

◆ ⚠ Safety instructions

- Do not use an IPM motor for an application where the motor is driven by the load and runs at a speed higher than the maximum motor speed.

◆ Combination of motor and inverter

- Use the same IPM motor capacity as the inverter capacity.
- Only one IPM motor can be connected to an inverter.
- An IPM motor cannot be driven by the commercial power supply.

◆ Installation

- While power is ON or for some time after power-OFF, do not touch the motor since the motor may be extremely hot. Touching these devices may cause a burn.
- The following table indicates the available installation orientations.

	Simplified diagram	Frame number	
		80M to 180L	200L to 280MD
Floor installation *1	Terminal direction A		⊙
	Terminal direction B		○
Wall installation *2	Shaft going up		△
	Shaft horizontal		⊙
	Shaft going down		×
Ceiling installation	Ceiling installation		⊙

⊙Standard models can be installed as they are.
 ○This can be used by an easy replacement.
 △This is supported by a dedicated product.
 ×Not available as installation strength is insufficient.

*1 The floor installation condition is applicable to a slope of up to 30°. If the slope is steeper, apply the wall installation condition.

*2 To install a horizontal motor to a wall, first attach a shelf that supports the motor legs.

◆ Wiring

- Connecting a commercial power supply to the input terminals (U, V, W) of a motor will burn it out. The motor must be connected with the output terminals (U, V, W) of the inverter.
- An IPM motor is a motor with permanent magnets embedded inside. High voltage is generated at the motor terminals while the motor is running. Before wiring or inspection, confirm that the motor is stopped.
 In an application, such as a fan or blower, where the motor is driven by the load, a low-voltage manual contactor must be connected at the inverter's output side, and wiring and inspection must be performed while the contactor is open. Otherwise an electric shock may be caused. The inverter power must be turned ON before closing the contacts of the contactor at the output side.
- Match the input terminals (U, V, W) of the motor and the output terminals (U, V, W) of the inverter when connecting.
- Use the following length of wiring or shorter when connecting an IPM motor.

Voltage class	Pr.72 setting (carrier frequency)	FR-F820-00077(1.5K) or lower	FR-F820-00105(2.2K) or higher
		FR-F840-00038(1.5K) or lower	FR-F840-00052(2.2K) or higher
200 V	0 (2 kHz) to 15 (14 kHz)	100 m	100 m
	5 (2 kHz) or lower	100 m	100 m
400 V	6 to 9 (6 kHz)	50 m	100 m
	10 (10 kHz) or higher	50 m	50 m

Use one dedicated IPM motor for one inverter. Multiple IPM motors cannot be connected to an inverter.

◆ Operation

- About 0.1 s (magnetic pole detection time) takes to start a motor after inputting a start signal.
- An IPM motor is a motor with embedded permanent magnets. Regression voltage is generated when the motor coasts at an instantaneous power failure or other incidents. The inverter's DC bus voltage increases if the motor coasts fast in this condition. When using the automatic restart after instantaneous power failure function, it is recommended to also use the regeneration avoidance operation to make startups stable.
- The number of IPM motor poles differs by the capacity. Thus, the relation between the rotation speed and the frequency setting is:

$$\text{Rotation speed} = 120 \times \frac{\text{frequency setting value}}{\text{number of motor poles}}$$

Speed [r/min]	Frequency setting value [Hz]		
	MM-EFS		MM-THE4
	0.75 to 15 kW	18.5 to 55 kW	75 to 160 kW
300	15	20	15
600	30	40	30
900	45	60	45
1200	60	80	60
1500	75	100	75
1800	90	120	90
2250	112.5	150	—*1
2400	120	—	—*1
2700	135	—	—*1
3000	150	—	—*1

*1 The maximum speed of MM-THE4 is 1800 r/min.

◆ Connection with machine

◆ Direct connection

- When installing, align the motor shaft center and the machine shaft. Insert a liner underneath the motor or the machine legs as required to make a perfect alignment.

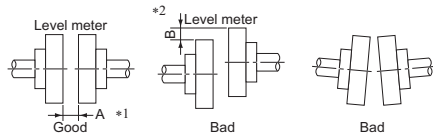

- *1 Set so that the A dimensions become the same dimension even when any position is measured by feeler gauge. (inequality in A width 3/100 mm or lower (2.5/100 mm or lower for MM-THE4))
- *2 Do not set parts with a vertical gap like B. (2.5/100 mm or lower for MM-THE4).

NOTE

- When a fan or blower is directly connected to the motor shaft or to the machine, the machine side may become unbalanced. When the unbalanced degree becomes larger, the motor vibration becomes larger and may result in a damage of the bearing or other area. The balance quality with the machine should meet the class G2.5 or lower of JISB0905 (the Balance Quality Requirements of Rigid Rotors).

◆ Connected by belt

- When installing, place the motor shaft and the machine shaft in parallel, and mount them to a position where their pulley centers are aligned. Their pulley centers should also have a right angle to each shaft.
- An excessively stretched belt may damage the bearing and break the shafts. A loose belt may slip off and easily deteriorate. A flat belt should be rotated lightly when it is pulled by one hand. For details, refer to the Instruction Manual of the motor.

◆ Connected by gear couplings

- Place the motor and machine shafts in parallel, and engage the gear teeth properly.

◆ Permissible vibration during operation

- During operation, the motor coupled to a load machine may vibrate according to the degree of coupling between the motor and the load, and the degree of vibration created by the load. The degree of the motor's vibration varies depending on the condition of the foundations and baseplate of the motor. The lower the vibration is, the better it is for the motor. The figure in this section shows a permissible level of vibration which does not interfere with use of the motor (though it depends on the motor speed, the installation condition of the motor, etc.). If the motor has higher vibration than the permissible level, investigate the cause, take measure, and take action.

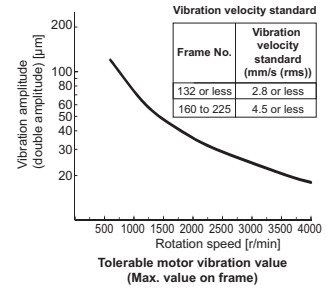

For further details of vibration, refer to the Instruction Manual of the motor.

◆ Permissible load of the shaft

- MM-EFS 1500 r/min

MM-EFS□1M	7	15	22	37	55	75	11K	15K
MM-EFS□1M4								
MM-EFS□1M-S10	-	-	-	-	-	-		
MM-EFS□1M4-S10								
L [mm] *1	40	50	60	80	110			
Permissible radial load [N] *2	535	585	830	1070	1710	2150		
Permissible thrust load [N] *2	470	500	695	900	1420	1810		

MM-EFS□1M	18K	22K	30K	37K	45K	55K
MM-EFS□1M4						
MM-EFS□1M-S10						
MM-EFS□1M4-S10						
L [mm] *1	110	140				
Permissible radial load [N] *2	2940	3230	4900	5880		
Permissible thrust load [N] *2	2350	2740	2940	2740		

- MM-EFS 3000 r/min

MM-EFS□3	7	15	22	37	55	75	11K	15K
MM-EFS□34								
L [mm] *1	40	50	60	80	110			
Permissible radial load [N] *2	440	490	830	1320	1660			
Permissible thrust load [N] *2	350	370	655	1020	1320			

- MM-THE4

MM-THE4	Capacities	75 kW	90 kW	110 kW	132 kW	160 kW
	Frame number	250MA	250MD	280MD	280MD	280MD
Permissible radial load [N] *2 *3		3600	3600	4600	4600	4600
Permissible thrust load [N] *2		3900	3900	5000	5000	5000

- *1 For the symbols used in the table, refer to the diagram at right.

- *2 The permissible radial load and the permissible thrust load are the permissible values when they are applied individually.

For the MM-EFS motor, the lifespan of its bearing will be as follows when permissible loads shown in the tables are applied.

Model	Lifespan of bearing
MM-EFS□1M(4)	Approx. 25000 hours
MM-EFS□1M(4)-S10	Approx. 25000 hours
MM-EFS□3(4)	Approx. 12500 hours

- *3 The loading point of the radial load is calculated at a tip of the shaft. Connecting by belt is available using an option. For the permissible radial load connected by belt, contact the nearest Mitsubishi Electric FA center.

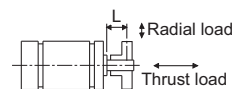

● Selection precautions

◆ Inverter capacity selection

- When operating a special motor or multiple motors in parallel by one inverter, select the inverter capacity so that 1.05 times of the total of the rated motor current becomes less than the rated output current of the inverter.
(Multiple PM motors cannot be connected to an inverter.)

◆ Starting torque of the motor

- The starting and acceleration characteristics of the motor driven by an inverter are restricted by the overload current rating of the inverter. In general, the torque characteristic has small value compared to when the motor is started by a commercial power supply. When a large starting torque is required, and torque boost adjustment, and Advanced magnetic flux vector control cannot generate the sufficient torque, increase both the motor and inverter capacities.

◆ Acceleration/deceleration time

- The motor acceleration/deceleration time is decided by the torque generated by the motor, load torque, and moment of inertia (J) of load.
- The required time may increase when the torque limit function or stall prevention function operates during acceleration/deceleration. In such a case, set the acceleration/deceleration time longer.
- To shorten the acceleration/deceleration time, increase the torque boost value (too large setting value may activate the stall prevention function, resulting in longer acceleration time at starting on the contrary). Alternatively, use Advanced magnetic flux vector control, or select the larger inverter and motor capacities. To shorten the deceleration time, use an addition brake unit (FR-BU2) to absorb braking energy, power regeneration common converter (FR-CV), or power supply regeneration unit (MT-RC), etc.

◆ Power transfer mechanisms (reduction gear, belt, chain, etc.)

- Caution is required for the low-speed continuous operation of the motor with an oil lubricated gear box, transmission, reduction gear, etc. in the power transfer mechanism. Such an operation may degrade the oil lubrication and cause seizing. On the other hand, the high-speed operation at more than 60 Hz may cause problems with the noise of the power transfer mechanism, life, or insufficient strength due to centrifugal force, etc. Fully take necessary precautions.

◆ Instructions for overload operation

- When performing frequent starts/stops by the inverter, rise/fall in the temperature of the transistor element of the inverter will repeat due to a repeated flow of large current, shortening the life from thermal fatigue. Since thermal fatigue is related to the amount of current, the life can be increased by reducing current at locked condition, starting current, etc. Reducing current may extend the service life but may also cause torque shortage, which leads to a start failure. Adding a margin to the current can eliminate such a condition. For an induction motor, use an inverter of a higher capacity. For an IPM motor, use an inverter and IPM motor of higher capacities.

● Precautions on peripheral device selection

◆ Selection and installation of molded case circuit breaker

Install a molded case circuit breaker (MCCB) on the power receiving side to protect the wiring at the inverter/the converter unit input side. Select an MCCB according to the inverter power supply side power factor, which depends on the power supply voltage, output frequency and load. Refer to **page 115**. Especially for a completely electromagnetic MCCB, a slightly large capacity must be selected since its operation characteristic varies with harmonic currents. (Check the reference material of the applicable breaker.) As an earth leakage circuit breaker, use the Mitsubishi Electric earth leakage circuit breaker designed for harmonics and surge suppression. (Refer to **page 114**.) When installing a molded case circuit breaker on the inverter output side, contact the manufacturer of each product for selection.

◆ Handling of the input side magnetic contactor (MC)

For the operation using external terminals (using the terminal STF or STR), install the input-side magnetic contactor to prevent accidents due to automatic restart when the power is restored after power failures such as an instantaneous power failure, or for safety during maintenance works. Do not use this magnetic contactor for frequent starting/stopping of the inverter. (The switching life of the converter part is about 1 million times.) In the operation by parameter unit, the automatic restart after power restoration is not performed and the magnetic contactor cannot be used to start the motor. The input-side magnetic contactor can stop the motor. However, the regenerative brake of the inverter does not operate, and the motor coasts to a stop.

◆ Handling of the output side magnetic contactor (MC)

- Switch the MC between the inverter and motor only when both the inverter and motor are at a stop. When the magnetic contactor is turned ON while the inverter is operating, overcurrent protection of the inverter and such will activate. When an MC is provided to switch to a commercial power supply, for example, it is recommended to use the electronic bypass function **Pr.135 to Pr.139**.
- Do not install a magnetic contactor at the inverter's output side when using a PM motor.

◆ Installation of thermal relay

In order to protect the motor from overheating, the inverter has an electronic thermal O/L relay. However, install an external thermal overcurrent relay (OCR) between the inverter and motors to operate several motors or a multi-pole motor with one inverter. In this case, set 0 A to the electronic thermal O/L relay setting of the inverter. For the external thermal overcurrent relay, determine the setting value in consideration of the current indicated on the motor's rating plate and the line-to-line leakage current. (**Refer to page 122**.)

Self cooling ability of a motor reduces in the low-speed operation. Installation of a thermal protector or a use of a motor with built-in thermistor is recommended.

◆ Output side measuring instrument

When the inverter-to-motor wiring length is long, especially for the 400 V class, small-capacity models, the meters and CTs may generate heat due to line-to-line leakage current. Therefore, choose the equipment which has enough allowance for the current rating.

When measuring and displaying the output voltage and output current of the inverter, use of the terminals AM and 5 output function of the inverter is recommended.

◆ **Disuse of power factor improving capacitor (power factor correction capacitor)**

The power factor improving capacitor and surge suppressor on the inverter output side may be overheated or damaged by the harmonic components of the inverter output. Also, since an excessive current flows in the inverter to activate overcurrent protection, do not provide a capacitor and surge suppressor. To improve the power factor, use a power factor improving DC reactor (on page 96).

◆ **Connection between the converter unit and the inverter**

- Perform wiring so that the commands sent from the converter unit are transmitted to the inverter without fail. Incorrect connection may damage the converter unit and the inverter.
- For the wiring length, refer to the table below.

Total wiring length	Across the terminals P and P and the terminals N and N	50 m or lower
	Other signal cables	30 m or lower

- For the cable gauge of the cable across the main circuit terminals P/+ and N/- (P and P, N and N), refer to page 116.

◆ **Electrical corrosion of the bearing**

When a motor is driven by the inverter, axial voltage is generated on the motor shaft, which may cause electrical corrosion of the bearing in rare cases depending on the wiring, load, operating conditions of the motor or specific inverter settings (high carrier frequency and EMC filter ON). Contact your sales representative to take appropriate countermeasures for the motor.

The following shows examples of countermeasures for the inverter.

- Decrease the carrier frequency.
- Turn OFF the EMC filter.
- Provide a common mode choke on the output side of the inverter.*1

(This is effective regardless of the EMC filter ON/OFF connector setting.)

*1 Recommended common mode choke: FT-3KM F series
FINEMET® common mode choke cores manufactured by Hitachi Metals, Ltd.
FINEMET is a registered trademark of Hitachi Metals, Ltd.

◆ **Cable gauge and wiring distance**

If the wiring distance is long between the inverter and motor, during the output of a low frequency in particular, use a large cable gauge for the main circuit cable to suppress the voltage drop to 2% or less. (The table on page 115 indicates a selection example for the wiring length of 20 m.)

Especially for long-distance wiring or wiring with shielded cables, the inverter may be affected by a charging current caused by stray capacitance of the wiring, leading to an incorrect activation of the overcurrent protective function. Refer to the maximum wiring length shown in the following table.

When multiple motors are connected, use the total wiring length shown in the table or shorter (100 m or shorter under PM motor control.)

Pr.72 setting (carrier frequency)	FR-F820-00046(0.75K), FR-F840-00023(0.75K)	FR-F820-00077(1.5K), FR-F840-00038(1.5K)	FR-F820-00105(2.2K) or higher, FR-F840-00052(2.2K) or higher
2 (2 kHz) or lower	300 m	500 m	500 m
3 (3 kHz) or higher	200 m	300 m	500 m

When the operation panel is installed away from the inverter and when the parameter unit is connected, use a recommended connection cable.

For the remote operation using analog signals, keep the distance between the remote speed setter and the inverter to 30 m or less. Also, to prevent induction from other devices, keep the wiring away from the power circuits (main circuit and relay sequential circuit).

When the frequency setting is performed using the external potentiometer, not using the parameter unit, use a shielded or

twisted cable as shown in the figure below. Connect the shield cable to the terminal 5, not to the earth (ground).

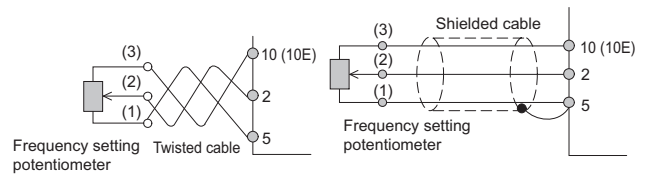

◆ **Earth (ground)**

When the inverter is set for the low acoustic noise operation, the leakage current increases compared to in the normal operation due to the high speed switching operation. Always earth (ground) the inverter, the converter unit, and the motor. Also, always use the earth (ground) terminal of the inverter/the converter unit for earthing (grounding). (Do not use a case or chassis.)

◆ **Electromagnetic interference (EMI)**

For the low acoustic noise operation with high carrier frequency, electromagnetic noise tends to increase. Take countermeasures by referring to the following examples. Depending on an installation condition, noise may affect the inverter also in the normal operation (initial status).

- Decrease the carrier frequency (Pr.72) setting to lower the EMI level.
- For countermeasures against the noise in AM radio broadcasting or malfunction of sensors, turn ON the EMC filter. (For the switching method, refer to the Instruction Manual.)
- For effective reduction of induction noise from the power cable of the inverter/the converter unit, secure the distance of 30 cm (at least 10 cm) from the power line and use a shielded twisted pair cable for the signal cable. Do not earth (ground) the shield, and connect the shield to a common terminal by itself.

EMI measure example

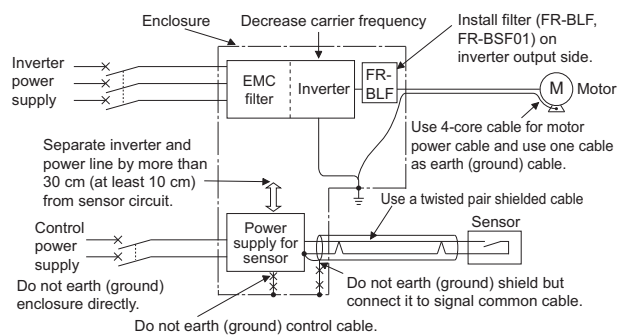

◆ **leakage current**

Capacitance exists between the inverter/the converter unit I/O cables and other cables or the earth, and within the motor, through which a leakage current flows. Since its value depends on the static capacitance, carrier frequency, etc., low acoustic noise operation at the increased carrier frequency of the inverter will increase the leakage current. Therefore, take the following countermeasures. Select the earth leakage circuit breaker according to its rated sensitivity current, independently of the carrier frequency setting.

◆ To-earth (ground) leakage currents

Type	Influence and countermeasure
Influence and countermeasure	<ul style="list-style-type: none"> Leakage currents may flow not only into the power system of the inverter and converter unit but also into the other power systems through the earthing (grounding) cable, etc. These leakage currents may operate earth leakage circuit breakers and earth leakage relays unnecessarily. Precautions <ul style="list-style-type: none"> If the carrier frequency setting is high, decrease the Pr.72 PWM frequency selection setting. However, the motor noise increases. Selecting Pr.240 Soft-PWM operation selection makes the sound inoffensive. By using earth leakage circuit breakers designed to suppress harmonics and surge voltage in the power system of the inverter and other devices, operation can be performed with the carrier frequency kept high (with low noise).
Transmission path	

◆ Line-to-line leakage current

Type	Influence and countermeasure
Influence and countermeasure	<ul style="list-style-type: none"> Line-to-line leakage current flows through the capacitance between the inverter/the converter unit output lines. Harmonic component of the leaked current may cause unnecessary operation of an external thermal relay. Long wiring length (50 m or longer) for the 400V class small capacity models (7.5 kW or lower) will increase the rate of leakage current against the rated motor current. In such a case, an unnecessary operation of the external thermal relay may be more liable to occur. Precautions <ul style="list-style-type: none"> Use Pr.9 Electronic thermal O/L relay. If the carrier frequency setting is high, decrease the Pr.72 PWM frequency selection setting. However, the motor noise increases. Selecting Pr.240 Soft-PWM operation selection makes the sound inoffensive. To protect motor securely without being subject to the influence of the line-to-line leakage current, direct detection of the motor temperature using a temperature sensor is recommended.
Transmission path	

◆ Harmonic Suppression Guidelines

Inverters have a converter section (rectifier circuit) and generate a harmonic current. Harmonic currents flow from the inverter to a power receiving point via a power transformer. The Harmonic Suppression Guidelines was established to protect other consumers from these outgoing harmonic currents. The three-phase 200 V input specifications 3.7 kW or lower were previously covered by the "Harmonic Suppression Guidelines for Household Appliances and General-purpose Products" and other models were covered by the "Harmonic Suppression Guidelines for Consumers Who Receive High Voltage or Special High Voltage". However, the general-purpose inverter has been excluded from the target products covered by the "Harmonic Suppression Guidelines for Household Appliances and General-purpose Products" in January 2004 and the "Harmonic Suppression Guideline for Household Appliances and General-purpose Products" was repealed on September 6, 2004. All capacity and all models of general-purpose inverter used by specific consumers are now covered by the "Harmonic Suppression Guidelines for Consumers Who Receive High Voltage or Special High Voltage".

• "Harmonic Suppression Guidelines for Consumers Who Receive High Voltage or Special High Voltage"
This guideline sets the maximum values of outgoing harmonic currents generated from a high-voltage or specially high-voltage receiving consumer who will install, add or renew harmonic generating equipment. If any of the maximum values is exceeded, this guideline requires that consumer to take certain suppression measures. The users who are not subjected to the above guidelines do not need follow the guidelines, but the users are recommended to connect a DC reactor and an AC reactor as usual. Compliance with the "Harmonic Suppression Guidelines for Consumers Who Receive High Voltage or Special High Voltage"

Input power	Target capacity	Countermeasure
Three-phase 200 V	All capacities	Confirm the compliance with the "Harmonic Suppression Guidelines for Consumers Who Receive High Voltage or Special High Voltage" published in September 1994 by the Ministry of International Trade and Industry (the present Japanese Ministry of Economy, Trade and Industry). Take countermeasures if required. Use the following materials as reference to calculate the power supply harmonics.
Three-phase 400 V		Reference materials <ul style="list-style-type: none"> "Harmonic Suppression Measures of the General-purpose Inverter" January 2004, Japan Electrical Manufacturers' Association "Calculation Method of Harmonic Current of the General-purpose Inverter Used by Specific Consumers" JEM-TR201 (Revised in December 2003), Japan Electrical Manufacturers' Association

For compliance to the "Harmonic Suppression Guideline of the General-purpose Inverter (Input Current of 20A or Less) for Consumers Other Than Specific Consumers" published by JEMA

Input power	Target capacity	Measures
Three-phase 200 V	3.7 kW or lower	Connect the AC reactor or DC reactor recommended in the Catalogs and Instruction Manuals. Reference materials <ul style="list-style-type: none"> "Harmonic suppression guideline of the general-purpose inverter (input current of 20A or less)" JEM-TR226 (Published in December 2003), Japan Electrical Manufacturers' Association

◆ Calculation of outgoing harmonic current

$$\text{Outgoing harmonic current} = \text{fundamental wave current (value converted from received power voltage)} \times \text{operation ratio} \times \text{harmonic content}$$

- Operation ratio: Operation ratio = actual load factor × operation time ratio during 30 minutes
- Harmonic content: Found in Table.

- Harmonic contents (values when the fundamental wave current is 100%)

Reactor	5th	7th	11th	13th	17th	19th	23rd	25th
Not used	65	41	8.5	7.7	4.3	3.1	2.6	1.8
Used (AC side)	38	14.5	7.4	3.4	3.2	1.9	1.7	1.3
Used (DC side)*1	30	13	8.4	5.0	4.7	3.2	3.0	2.2
Used (AC, DC sides)*1	28	9.1	7.2	4.1	3.2	2.4	1.6	1.4

*1 The converter unit (FR-CC2) and the IP55 compatible model are equipped with a DC reactor on its DC side.

- Rated capacities and outgoing harmonic currents when driven by inverter

Applied motor kW	Fundamental wave current (A)		Fundamental wave current converted from 6.6 kV (mA)	Rated capacity (kVA)	Outgoing harmonic current converted from 6.6 kV (mA) (No reactor, 100% operation ratio)							
	200 V	400 V			5th	7th	11th	13th	17th	19th	23rd	25th
0.4	1.61	0.81	49	0.57	31.85	20.09	4.165	3.773	2.107	1.519	1.274	0.882
0.75	2.74	1.37	83	0.97	53.95	34.03	7.055	6.391	3.569	2.573	2.158	1.494
1.5	5.50	2.75	167	1.95	108.6	68.47	14.20	12.86	7.181	5.177	4.342	3.006
2.2	7.93	3.96	240	2.81	156.0	98.40	20.40	18.48	10.32	7.440	6.240	4.320
3.7	13.0	6.50	394	4.61	257.1	161.5	33.49	30.34	16.94	12.21	10.24	7.092
5.5	19.1	9.55	579	6.77	376.1	237.4	49.22	44.58	24.90	17.95	15.05	10.42
7.5	25.6	12.8	776	9.07	504.4	318.2	65.96	59.75	33.37	24.06	20.18	13.97
11	36.9	18.5	1121	13.1	728.7	459.6	95.29	86.32	48.20	34.75	29.15	20.18
15	49.8	24.9	1509	17.6	980.9	618.7	128.3	116.2	64.89	46.78	39.24	27.16
18.5	61.4	30.7	1860	21.8	1209	762.6	158.1	143.2	79.98	57.66	48.36	33.48
22	73.1	36.6	2220	25.9	1443	910.2	188.7	170.9	95.46	68.82	57.72	39.96
30	98.0	49.0	2970	34.7	1931	1218	252.5	228.7	127.7	92.07	77.22	53.46
37	121	60.4	3660	42.8	2379	1501	311.1	281.8	157.4	113.5	95.16	65.88
45	147	73.5	4450	52.1	2893	1825	378.3	342.7	191.4	138.0	115.7	80.10
55	180	89.9	5450	63.7	3543	2235	463.3	419.7	234.4	169.0	141.7	98.10

Applied motor kW	Fundamental wave current (A)		Fundamental wave current converted from 6.6 kV (mA)	Rated capacity (kVA)	Outgoing harmonic current converted from 6.6 kV (mA) (With a DC reactor, 100% operation ratio)							
	200 V	400 V			5th	7th	11th	13th	17th	19th	23rd	25th
75	245	123	7455	87.2	2237	969	626	373	350	239	224	164
90	293	147	8909	104	2673	1158	748	445	419	285	267	196
110	357	179	10848	127	3254	1410	911	542	510	347	325	239
132	-	216	13091	153	3927	1702	1100	655	615	419	393	288
160	-	258	15636	183	4691	2033	1313	782	735	500	469	344
220	-	355	21515	252	6455	2797	1807	1076	1011	688	645	473
250	-	403	24424	286	7327	3175	2052	1221	1148	782	733	537
280	-	450	27273	319	8182	3545	2291	1364	1282	873	818	600
315	-	506	30667	359	9200	3987	2576	1533	1441	981	920	675
355	-	571	34606	405	10382	4499	2907	1730	1627	1107	1038	761
400	-	643	38970	456	11691	5066	3274	1949	1832	1247	1169	857
450	-	723	43818	512	13146	5696	3681	2191	2060	1402	1315	964
500	-	804	48727	570	14618	6335	4093	2436	2290	1559	1462	1072
560	-	900	54545	638	16364	7091	4582	2727	2564	1746	1636	1200
630	-	1013	61394	718	18418	7981	5157	3070	2886	1965	1842	1351

- Conversion factors

Classification	Circuit type		Conversion coefficient Ki
3	Three-phase bridge (Capacitor smoothing)	Without reactor	K31 = 3.4
		With reactor (AC side)	K32 = 1.8
		With reactor (DC side)	K33 = 1.8
		With reactors (AC, DC sides)	K34 = 1.4
5	Self-excitation three-phase bridge	When a high power factor converter is used	K5 = 0

Compatible Motors

List of applicable inverter models by rating (according to the motor capacity)

For the combinations within the thick boarders, always connect a DC reactor (FR-HEL), which is available as an option.

200 V class (model: FR-F820-[])

Motor capacity (kW) ^{*1}	DC reactor	SLD (superlight load)			LD (light load)		
	FR-HEL-[]	Model	Rated current (A)	Model	Rated current (A)		
0.75	0.75K	0.75K	00046	4.6	0.75K	00046	4.2
1.5	1.5K	1.5K	00077	7.7	1.5K	00077	7
2.2	2.2K	2.2K	00105	10.5	2.2K	00105	9.6
3.7	3.7K	3.7K	00167	16.7	3.7K	00167	15.2
5.5	5.5K	5.5K	00250	25	5.5K	00250	23
7.5	7.5K	7.5K	00340	34	7.5K	00340	31
11	11K	11K	00490	49	11K	00490	45
15	15K	15K	00630	63	15K	00630	58
18.5	18.5K	18.5K	00770	77	18.5K	00770	70.5
22	22K	22K	00930	93	22K	00930	85
30	30K	30K	01250	125	30K	01250	114
37	37K	37K	01540	154	37K	01540	140
45	45K	45K	01870	187	45K	01870	170
55	55K	55K	02330	233	55K	02330	212
75	75K	75K	03160	316	75K	03160	288
90	90K	90K	03800	380	90K	03800	346
110	110K	110K	04750	475	110K	04750	432
132	110K ^{*2}	110K	04750	475	-	-	-

400 V class (model: FR-F840-[])

Motor capacity (kW) ^{*1}	DC reactor	SLD (superlight load)			LD (light load)		
	FR-HEL-[]	Model	Rated current (A)	Model	Rated current (A)		
0.75	H0.75K	0.75K	00023	2.3	0.75K	00023	2.1
1.5	H1.5K	1.5K	00038	3.8	1.5K	00038	3.5
2.2	H2.2K	2.2K	00052	5.2	2.2K	00052	4.8
3.7	H3.7K	3.7K	00083	8.3	3.7K	00083	7.6
5.5	H5.5K	5.5K	00126	12.6	5.5K	00126	11.5
7.5	H7.5K	7.5K	00170	17	7.5K	00170	16
11	H11K	11K	00250	25	11K	00250	23
15	H15K	15K	00310	31	15K	00310	29
18.5	H18.5K	18.5K	00380	38	18.5K	00380	35
22	H22K	22K	00470	47	22K	00470	43
30	H30K	30K	00620	62	30K	00620	57
37	H37K	37K	00770	77	37K	00770	70
45	H45K	45K	00930	93	45K	00930	85
55	H55K	55K	01160	116	55K	01160	106
75	H75K	75K	01800	180	75K	01800	144
90	H90K	90K	02160	216	90K	02160	180
110	H110K	110K	02600	260	110K	02600	216
132	H132K	132K	03250	325	132K	03250	260
160	H160K	160K	03610	361	160K	03610	325
185	H185K	185K	04320	432	185K	04320	361
220	H220K	220K	04810	481	220K	04810	432
250	H250K	250K	05470	547	250K	05470	481
280	H280K	280K	06100	610	280K	06100	547
315	H315K	315K	06830	683	315K	06830	610
355	H355K	355K	07700	770	-	-	-

400 V class (model: FR-F842-[])

Motor capacity (kW) ^{*1}	Converter unit	SLD (superlight load)			LD (light load)		
	FR-CC2-[]	Model	Rated current (A)	Model	Rated current (A)		
355	H355K	-	-	-	355K	07700	683
400	H400K	355K	07700	770	400K	08660	770
450	H450K	400K	08660	866	450K	09620	866
500	H500K	450K	09620	962	500K	10940	962
560	H560K	500K	10940	1094	560K	12120	1094
630	H630K	560K	12120	1212	-	-	-

*1 Indicates the maximum capacity applicable with the Mitsubishi Electric 4-pole standard motor.

*2 The FR-HEL-110K supports the 200 V class 132 kW motor.

Overload current rating

SLD	110% 60 s, 120% 3 s (inverse-time characteristics) at surrounding air temperature of 40°C
LD	120% 60 s, 150% 3 s (inverse-time characteristics) at surrounding air temperature of 50°C

● Mitsubishi Electric High-performance energy-saving motor superline premium series SF-PR



◆ One motor conforms to the power supply in Japan and the United States.

- The Japanese domestic three ratings conform to the Top Runner Standard of the "Act on the Rational Use of Energy (energy saving law)" to be applied on 1st April, 2015.
- The United States ratings conform to the Energy Independence and Security Act (EISA).

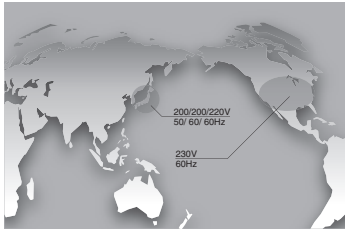

200	200	220	230	V
50	60	60	60	Hz

* For the 200 V class

In Japan In the United States

◆ Interchangeable installation size

- Replacement can be smoothly performed because the installation size (frame number) is compatible with our standard efficiency motor SF-JR series.
- It is possible to use a power distribution control equipment (thermal relay and breaker), which is the same as a conventional model.

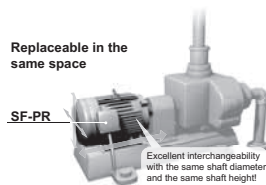

- *1 For the frame number 180 LD or higher and some models of the 6-pole product, the total length or diametrical dimension is greatly different.
- *2 The frame number is different from 1.5 kW6P (112M), 2.2 kW6P (132S) of the SF-JR models.
- *3 When replacing the SF-JR to the SF-PR, it is required to consider upgrading the contactor to secure the same electric durability as using the SF-JR because the electric durability of the contactor may reduce by about 30%. Besides, when replacing the SF-JR to the SF-PR, the existing thermal relay may trip depending on the operating conditions (long starting time). As a countermeasure, consider "Adjusting the heater set value of the thermal" or "Adopting the thermal with a saturated reactor", etc.
- *4 If the breaker NF400-SW manufactured by Mitsubishi Electric is used with the 55 kW motor, change the breaker. (Change the rated current of the breaker NF400-SW from 300 A to 350 A.)

We have released the superline premium series SF-PR models compatible with the Top Runner Standard in Japan, which is equivalent with IE3 premium efficiency for three-phase motors, and with the Energy Independence and Security Act (EISA) in the United States.

The SF-PR has achieved the efficiency class IE3 with the same dimensions as those of conventional models using our unique technology of the steel plate frame and new core materials. It maintains interchangeability with our standard efficiency motor SF-JR and easy replacement becomes possible.

By adopting a high-efficiency motor, energy savings in plant facilities and reduction of electricity consumption are expected, as well as the effects of recovering the investment cost.

◆ Introduction effects of the superline premium series SF-PR

The SF-PR motor conforms to the Top Runner Standard (IE3 equivalent), which remarkably reduces its operation cost (electricity charges) and greatly contributes minimization of TCO (Total Cost Ownership).

- Trial calculation example of an annual saved sum of money (at upgrading the motor from energy-efficiency class IE1 to IE3)

Motor with 4-poles 200 V 50 Hz

Annual saved sum of money (yen)

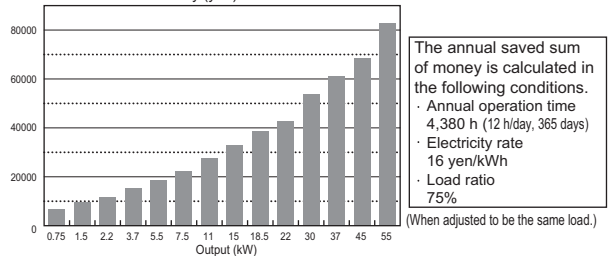

- Economic efficiency on an energy saving effect

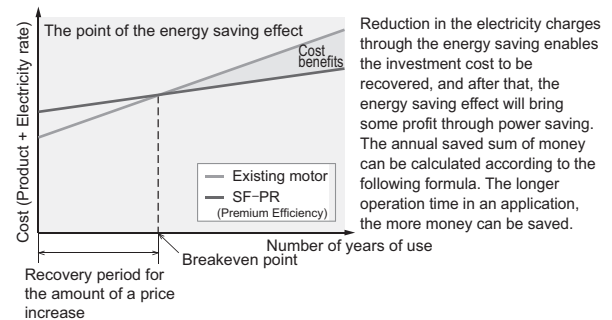

<Calculation formula>

$$\text{Output (kW)} \times \left(\frac{100}{\text{Efficiency of current motor (\%)}} - \frac{100}{\text{Efficiency of SF-PR model (\%)}} \right) \times \text{Number of motors} \times \text{Number of hours of use (h/day)} \times \text{Number of days of operation (day/year)} \times \text{Electricity rate (yen/kWh)}$$

When replacing our standard motor SF-JR with the SF-PR on the ventilation fan in plant

<Condition>
 Type : 11 kW 4P 200 V 50 Hz 75% load
 Units : 10 units
 Operation time : 12 h/day 365 day/year
 Electricity rate : 16 yen/kWh

Reduced cost of about 350,000 yen per year

Trial calculation results in replacing the SF-JR with the SF-PR with improved efficiency by 5% under the same conditions of the load factor, operation time, and electricity charges, etc.

◆ Lineup

• Model **S F - P R V O B - K R**

Symbol	Structure	Symbol	Enclosure type	Symbol	Series	Symbol	Installation	Symbol	Classification	Symbol	With or without brake	Symbol	Country code
S	Superline series	F	Totally enclosed fan-cooled	PR	Premium series Steel plate frame	None	Foot mounting type	None	Indoor type (IP44)	None	Without brake	None	Japan and the U.S.A.
						V	Vertical type	O	Outdoor type (IP44)	B	With brake	UL	US UL standard
						F	Flange type	P	Dust-proof and waterproof type (IP55)			KR	Korea
												EU	Europe
												CN	China

• Available models

Type	Totally-enclosed fan-cooled type														
	Foot mounting type			Vertical type			Flange type			Outdoor type			Dustproof/waterproof type		
Model	SF-PR			SF-PRV			SF-PRF			SF-PRO			SF-PRP		
Number of poles	2	4	6	2	4	6	2	4	6	2	4	6	2	4	6
Output (kW)	0.75	•	•	•	•	•	•	•	•	•	•	•	•	•	•
	1.5	•	•	•	•	•	•	•	•	•	•	•	•	•	•
	2.2	•	•	•	•	•	•	•	•	•	•	•	•	•	•
	3.7	•	•	•	•	•	•	•	•	•	•	•	•	•	•
	5.5	•	•	•	•	•	•	•	•	•	•	•	•	•	•
	7.5	•	•	•	•	•	•	•	•	•	•	•	•	•	•
	11	•	•	•	•	•	•	•	•	•	•	•	•	•	•
	15	•	•	•	•	•	•	•	•	•	•	•	•	•	•
	18.5	•	•	•	•	•	•	•	•	•	•	•	•	•	•
	22	•	•	•	•	•	•	•	•	•	•	•	•	•	•
	30	•	•	•	•	•	•	•	•	•	•	•	•	•	•
	37	•	•	•	•	•	•	•	•	•	•	•	•	•	•
	45	•	•	•	•	•	•	•	•	•	•	•	•	•	•
55	•	•	—	•	•	—	—	—	—	•	•	—	•	•	—

• The vertical type and the flange type are also available for the outdoor type and the dustproof/waterproof type.

• Available

● The SF-PR best matches Mitsubishi Electric inverters

◆ Enables a constant-torque operation in the low-speed range (expanding the constant-torque range)

- Combining with the standard motor SF-PR enables a constant-torque operation in the low-speed range.
- The SF-PR has superior performance to the SF-HRCA.
- The 400V class motors are insulation-enhanced motors as standard.

◆ Combination with Advanced magnetic flux vector control

Enables a constant-torque operation down to 0.5 Hz in a super low-speed range.

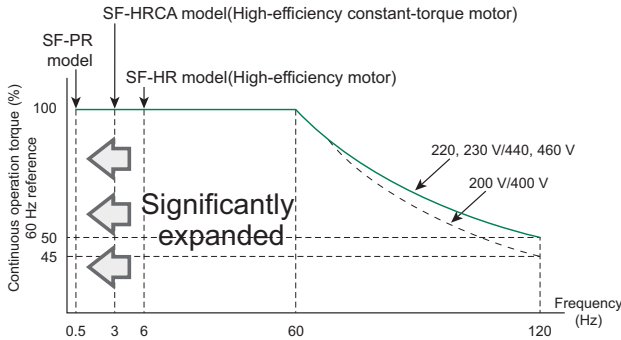

◆ Combination with V/F control

Enables a constant-torque operation down to 6 Hz in a low-speed range.

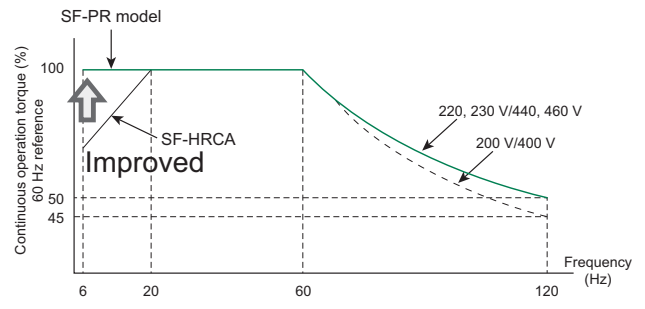

60 Hz torque reference indicates that the rated motor torque is 100% during 60 Hz operation.

◆ Motor torque

The following shows torque characteristics of the high-performance, energy-saving motor (SF-PR, 4-pole) in combination with an inverter with the LD rating. The overload capacity decreases for the SLD rating. Observe the specified range of the inverter.

◆ Maximum short-time torque

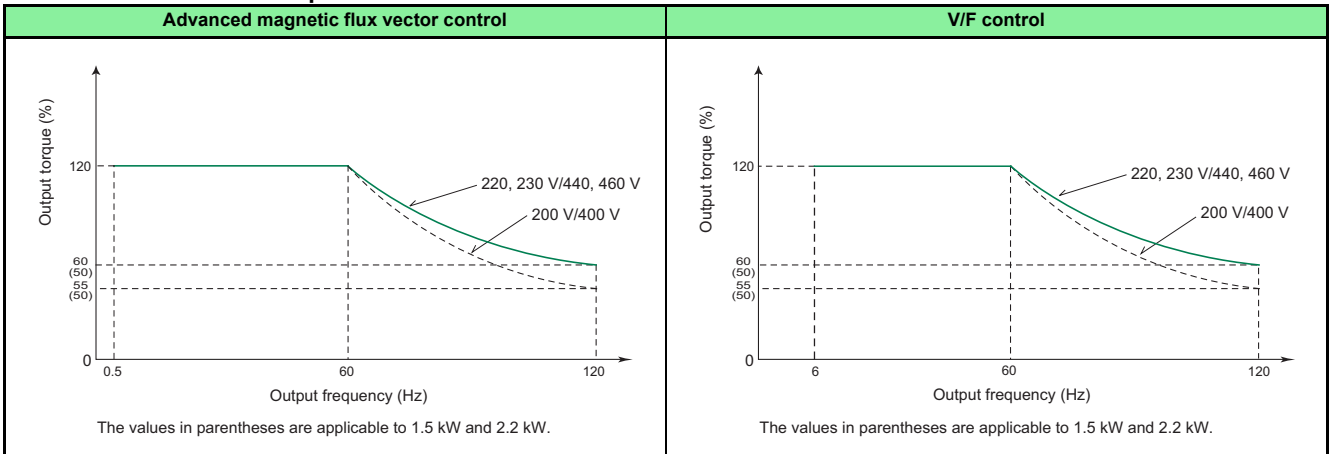

◆ Continuous torque

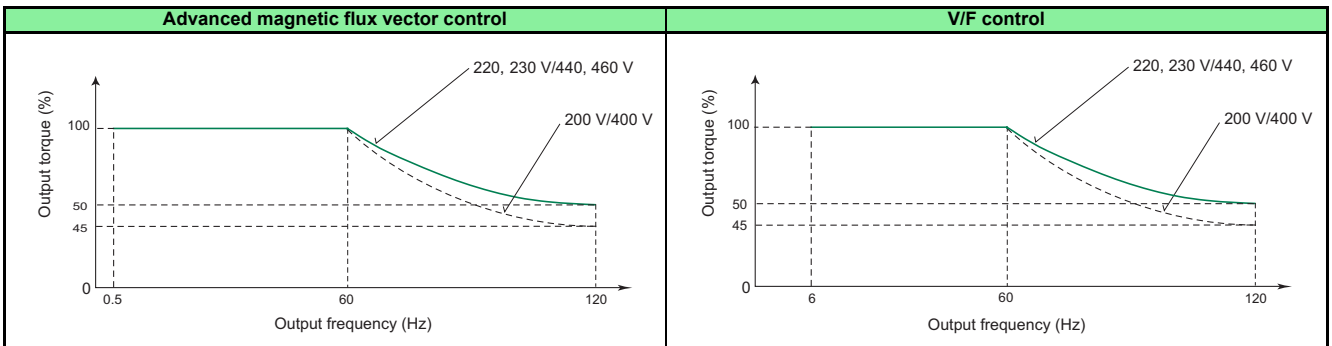

● Application to standard motors

When the Mitsubishi Electric standard squirrel-cage motor (SF-JR, 4-pole) and inverter of the same capacity are used, the torque characteristics are as shown below.

◆ Output characteristics

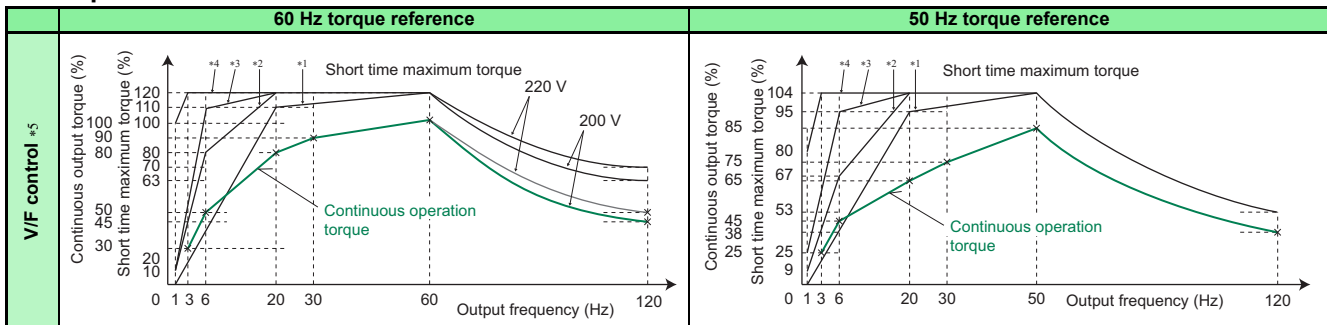

- *1 Torque boost minimum (0%)
- *2 Torque boost standard (initial value)
- *3 Torque boost large
10%: FR-F820-00046(0.75K), FR-F840-00023(0.75K)
7%: FR-F820-00077(1.5K) to FR-F820-00167(3.7K), FR-F840-00038(1.5K) to FR-F840-00083(3.7K)
6%: FR-F820-00250(5.5K), FR-F820-00340(7.5K), FR-F840-00126(5.5K), FR-F840-00170(7.5K)
4%: FR-F820-00490(11K) or higher, FR-F840-00250(11K) or higher
- *4 Torque boost adjustment (3.7 kW or lower)
- *5 Under V/F control, all of SF-JR 2-pole, 4-pole, and 6-pole motors have the same torque characteristics.

- A 60 Hz torque reference indicates that the rated torque of the motor running at 60 Hz is 100%, and a 50 Hz torque reference indicates that the rated torque of the motor running at 50 Hz is 100%
- A general-purpose squirrel cage motor must be used at lower continuous operating torque in rated operation as shown in the chart since the cooling capability of the fan installed on the rotor reduces at a lower speed. (Instantaneous torque occurs.)
- The torque with 200 or 220 V at 60 Hz or 200 V at 50 Hz in the chart indicates a motor torque reference (base frequency set in **Pr.3** of the inverter) and is not the frequency of the power supply. In a 50 Hz power supply area, the 60 Hz setting can be set.
- As shown in the chart, the 60 Hz torque reference setting can bring out the 100% torque of the motor continuously, enabling more efficient use of the motor.
- When continuously operating a motor with the 50 Hz torque reference setting, set the load torque to 85% or lower.
- This chart shows the characteristic available when a constant-torque load is selected for load pattern selection (**Pr. 14**).

◆ Motor loss and temperature rise

The motor operated by the inverter has a limit on the continuous operating torque since it is slightly higher in temperature rise than the one operated by a commercial power supply. At a low speed, reduce the output torque of the motor since the cooling effect decreases. When 100% torque is needed continuously at low speed, consider using a constant-torque motor.

◆ Torque characteristic

The motor operated by the inverter may be less in motor torque (especially starting torque) than the one driven by the commercial power supply. It is necessary to fully check the load torque characteristic of the machine.

◆ Vibration

The machine-installed motor operated by the inverter may be slightly greater in vibration than the one driven by the commercial power supply. The possible causes of vibration are as follows.

- Vibration due to imbalance of the rotator itself including the machine
- Resonance due to the natural oscillation of the mechanical system. Caution is required especially when the machine used at constant speed is operated at variable speed. The frequency jump function allows resonance points to be avoided during operation. (During acceleration/deceleration, the frequency within the setting range is passed through.) An effect is also produced if **Pr.72 PWM frequency selection** is changed. When a two-pole motor is operated at higher than 60 Hz, caution should be taken since such an operation may cause abnormal vibration.

● Application to constant-torque motors

Since a constant-torque motor is greater in current than the standard motor, the inverter capacity may be one rank higher. For a constant-torque motor, decrease **Pr.0 Torque boost** setting.

Recommended value 0.75 kW... 6%, 1.5 to 3.7 kW... 4%, 5.5 to 7.5 kW...3%, 11 to 37 kW...2%, 45 to 55 kW...1.5%, 75 kW or higher...1%

When two or more motors are operated synchronously, torque imbalance is likely to occur as motor slip is smaller than that of the standard motor.

● Application to premium high-efficiency IPM motor [MM-EFS (1500 r/min specification) series]

◆ Motor specification

Motor model	200 V class MM-EFS[]1M(-S10)*4	7	15	22	37	55	75	11K	15K	18K	22K	30K	37K	45K	55K	
	400 V class MM-EFS[]1M4(-S10)*4															
Compatible inverter*3	200 V class FR-F820-[]	00046 (0.75K)	00077 (1.5K)	00105 (2.2K)	00167 (3.7K)	00250 (5.5K)	00340 (7.5K)	00490 (11K)	00630 (15K)	00770 (18.5K)	00930 (22K)	01250 (30K)	01540 (37K)	01870 (45K)	02330 (55K)	
	400 V class FR-F840-[]	00023 (0.75K)	00038 (1.5K)	00052 (2.2K)	00083 (3.7K)	00126 (5.5K)	00170 (7.5K)	00250 (11K)	00310 (15K)	00380 (18.5K)	00470 (22K)	00620 (30K)	00770 (37K)	00930 (45K)	01160 (55K)	
Continuous characteristic *1	Rated output (kW)	0.75	1.5	2.2	3.7	5.5	7.5	11	15	18.5	22	30	37	45	55	
	Rated torque (N·m)	4.77	9.55	14	23.6	35	47.7	70	95.5	118	140	191	236	286	350	
	Rated speed (r/min)	1500														
	Maximum speed (r/min)	2250														
	Number of poles	6											8			
	Maximum torque	120% 60 s														
	Frame number	80M	90L	100L	112M	132S	132M	160M	160L	180M	180L	200L	200L	225S	225S	
	Inertia moment J ($\times 10^{-4}$ kg·m ²)	20	40	55	110	275	280	760	770	1700	1700	1900	3400	3850	6500	
Rated current (A)	200 V class	3	6.0	8.2	13.4	20	27	40	54	66	79	110	128	157	194	
	400 V class	1.5	3.0	4.1	6.7	10	13.5	20	27	33	39.5	55	64	78.5	97	
	Structure	Totally-enclosed fan-cooled motor. With steel framed legs. (protective structure IP44 *2)														
	Insulation class	155 (F)														
	Vibration class	V15														
Environment	Surrounding air temperature and humidity	-10°C to +40°C (non-freezing) · 90%RH or less (non-condensing)														
	Storage temperature and humidity	-20°C to +70°C (non-freezing) · 90%RH or less (non-condensing)														
	Atmosphere	Indoors (not under direct sunlight), and free from corrosive gas, flammable gas, oil mist, dust and dirt.														
	Altitude	Maximum 1000 m														
	Vibration	4.9 m/s ²														
Mass (kg)		11	15	22	31	50	53	95	100	135	155	220	230	290		

- *1 The above characteristics apply when the rated AC voltage is input from the inverter (refer to page 21). Output and rated motor speed are not guaranteed when the power supply voltage drops.
- *2 This excludes the part where the axis passes through.
- *3 For the LD rating
- *4 The belt drive models (MM-EFS[]1M-S10 and MM-EFS[]1M4-S10) are available in the capacity of 11 kW or higher.

◆ Motor torque characteristic

The following figure shows the torque characteristic of the premium high-efficiency IPM motor [MM-EFS (1500 r/min) series] when used with an inverter.

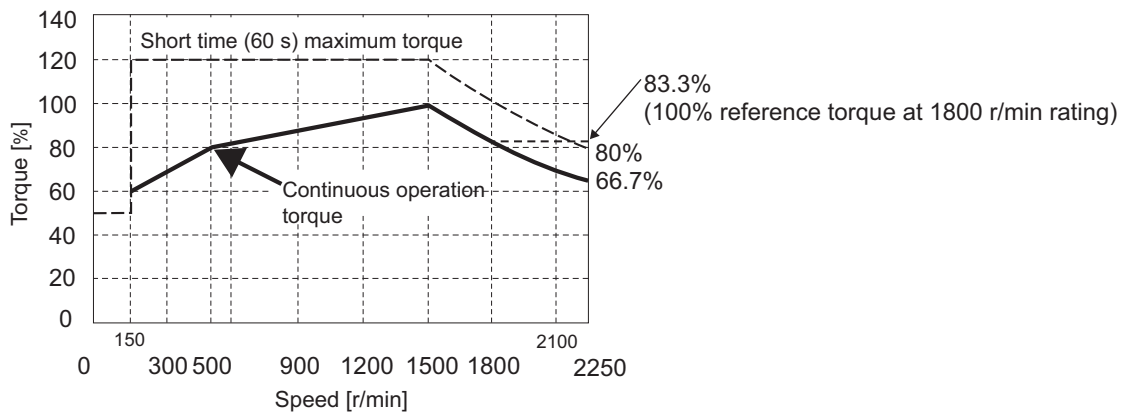

NOTE

- The motor can also be used for applications which require the rated speed of 1800 r/min.
- The torque characteristic is when the armature winding temperature is 20°C, and the input voltage to the inverter is 200 VAC or 400 VAC.
- Constant-speed operation cannot be performed for the speed of 150 r/min or less.
- For driving an 11 kW or higher MM-EFS motor connected to a belt, contact your sales representative.
- The standard models (MM-EFS[]1M and MM-EFS[]1M4) of 11 kW capacity or higher are designed for a direct connection only.

◆ Motor outline dimensions

- 30K or lower

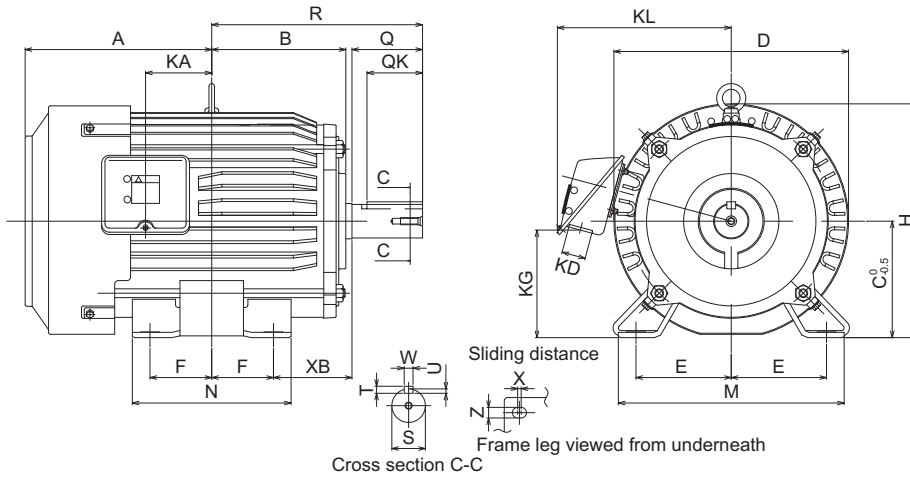

Model	Output (kW)	Frame No.	Outline dimension (mm)																							
			A	B	C	D	E	F	H	KA	KD	KG	KL	M	N	XB	Q	QK	R	S	T	U	W	X	Z	
200 V class MM-EFS[]1M4 (-S10)	7	0.75	80M	122	93	80	162	62.5	50	166	39.5	27	63	145	160	125	50	40	32	140	φ19j6	6	3.5	6	15	9
	15	1.5	90L	143	111.5	90	184	70	62.5	191	53	27	76	158	175	150	56	50	40	168.5	φ24j6	7	4	8	15	9
	22	2.2	100L	173	128	100	207	80	70	203.5	65	27	88	169	200	180	63	60	45	193	φ28j6	7	4	8	4	12
	37	3.7	112M	181	135	112	228	95	70	226	69	27	103	180	230	180	70	60	45	200	φ28j6	7	4	8	4	12
	55	5.5	132S	211.5	152	132	266	108	70	265	75	27	120	197	256	180	89	80	63	239	φ38k6	8	5	10	4	12
400 V class MM-EFS[]1M4 (-S10)	75	7.5	132M	230.5	171	132	266	108	89	265	94	27	120	197	256	218	89	80	63	258	φ38k6	8	5	10	4	12
	11K	11	160M	252	198	160	318	127	105	316	105	56	142	266	310	254	108	110	90	323	φ42k6	8	5	12	4	14.5
	15K	15	160L	274	220	160	318	127	127	316	127	56	142	266	310	298	108	110	90	345	φ42k6	8	5	12	4	14.5
	18K	18.5	180M	292.5	225.5	180	363	139.5	120.5	359	127	56	168	289	335	285	121	110	90	351.5	φ48k6	9	5.5	14	4	14.5
	22K	22		292.5	225.5	180	363	139.5	120.5	359	127	56	168	289	335	285	121	110	90	351.5	φ48k6	9	5.5	14	4	14.5
	30K	30	180L	311.5	242.5	180	363	139.5	139.5	359	146	56	168	289	335	323	121	110	90	370.5	φ55m6	10	6	16	4	14.5

- 37K to 55K

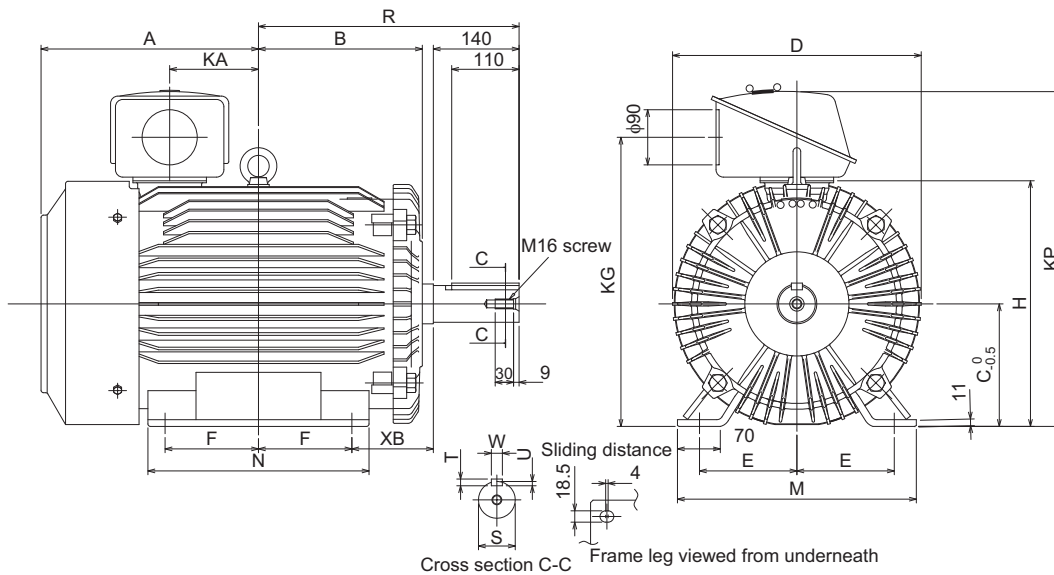

Model	Output (kW)	Frame No.	Outline dimension (mm)																		
			A	B	C	D	E	F	H	KA	KG	KP	M	N	XB	R	S	T	U	W	
200 V class MM-EFS[]1M (-S10)	37K	37	200L	355	267.5	200	406	159	152.5	401	145	472	548	390	361	133	425.5	φ60m6	11	7	18
	45K	45		355	267.5	200	406	159	152.5	401	145	472	548	390	361	133	425.5	φ60m6	11	7	18
400 V class MM-EFS[]1M4 (-S10)	55K	55	225S	365	277	225	446	178	143	446	145	517	593	428	342	149	432	φ65m6	11	7	18

NOTE

- The drawings shown above are sample outline dimension drawings. The outer appearance may differ depending on the frame number.

● Application to premium high-efficiency IPM motor [MM-EFS (3000 r/min specification) series]

◆ Motor specification

Motor model	200 V class MM-EFS[]3	7	15	22	37	55	75	11K	15K
	400 V class MM-EFS[]34								
Compatible inverter*3	200 V class FR-F820-[]	00046 (0.75K)	00077 (1.5K)	00105 (2.2K)	00167 (3.7K)	00250 (5.5K)	00340 (7.5K)	00490 (11K)	00630 (15K)
	400 V class FR-F840-[]	00023 (0.75K)	00038 (1.5K)	00052 (2.2K)	00083 (3.7K)	00126 (5.5K)	00170 (7.5K)	00250 (11K)	00310 (15K)
Continuous characteristic *1	Rated output (kW)	0.75	1.5	2.2	3.7	5.5	7.5	11	15
	Rated torque (N·m)	2.39	4.77	7.0	11.8	17.5	23.9	35.0	47.7
Rated speed (r/min)		3000							
Maximum speed (r/min)		4000							
Number of poles		6							
Maximum torque		120% 60s							
Frame number		80M	90L		112M	132S		160M	
Inertia moment J ($\times 10^{-4}$ kg·m ²)		10.7	22.4	29.8	68.3	198		534	
Rated current (A)	200 V class	3.2	6.1	8.4	14.3	21.4	28.7	37.6	51.4
	400 V class	1.6	3.1	4.2	7.2	10.7	14.4	18.8	25.7
Structure		Totally-enclosed fan-cooled motor. With steel framed legs. (protective structure IP44 *2)							
Insulation class		155 (F)							
Vibration class		V15							
Environment	Surrounding air temperature and humidity	-10°C to +40°C (non-freezing) · 90%RH or less (non-condensing)							
	Storage temperature and humidity	-20°C to +70°C (non-freezing) · 90%RH or less (non-condensing)							
	Atmosphere	Indoors (not under direct sunlight), and free from corrosive gas, flammable gas, oil mist, dust and dirt.							
	Altitude	Maximum 1000 m							
	Vibration	4.9 m/s ²							
Mass (kg)		8	12	14	25	41		75	

- *1 The above characteristics apply when the rated AC voltage is input from the inverter (refer to page 21). Output and rated motor speed are not guaranteed when the power supply voltage drops.
- *2 This excludes the part where the axis passes through.
- *3 For the LD rating

◆ Motor torque characteristic

The following figure shows the torque characteristic of the premium high-efficiency IPM motor [MM-EFS (3000 r/min) specification] when used with an inverter.

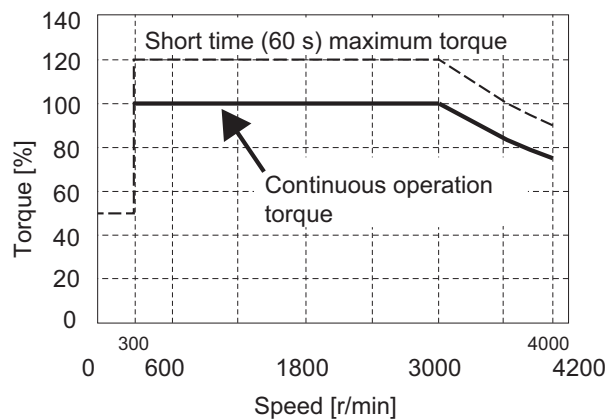

NOTE

- The torque characteristic is when the armature winding temperature is 20°C, and the input voltage to the inverter is 200 VAC or 400 VAC.
- Constant-speed operation cannot be performed for the speed of 300 r/min or less.
- The MM-EFS[]3 or MM-EFS[]34 motor with an 11 kW or higher capacity is designed for a direct connection only.

◆ Motor outline dimensions

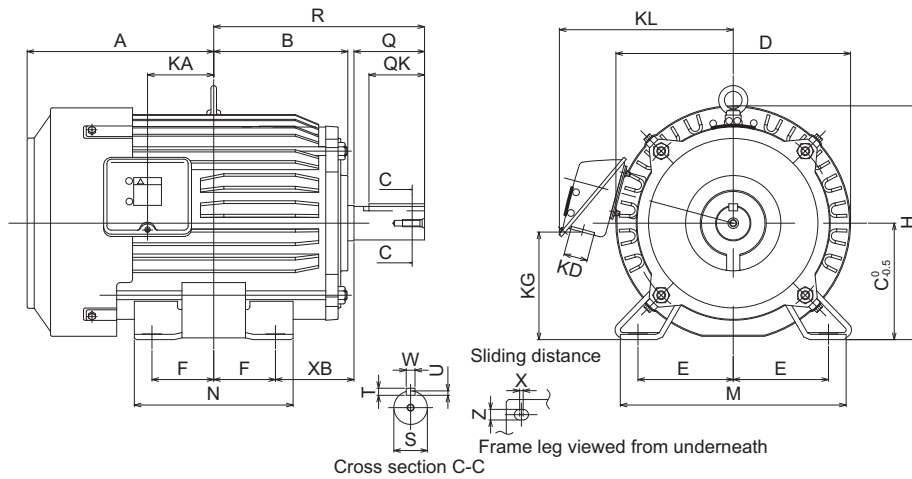

Model	Output (kW)	Frame No.	Outline dimension (mm)																							
			A	B	C	D	E	F	H	KA	KD	KG	KL	M	N	XB	Q	QK	R	S	T	U	W	X	Z	
200 V class MM-EFS[]3	7	0.75	80M	122	93	80	162	62.5	50	166	39.5	27	63	145	160	125	50	40	32	140	φ19j6	6	3.5	6	15	9
	15	1.5	90L	143	111.5	90	184	70	62.5	191	53	27	76	158	175	150	56	50	40	168.5	φ24j6	7	4	8	15	9
	22	2.2		181	135	112	228	95	70	226	69	27	103	180	230	180	70	60	45	200	φ28j6	7	4	8	4	12
400 V class MM-EFS[]34	37	3.7	112M	181	135	112	228	95	70	226	69	27	103	180	230	180	70	60	45	200	φ28j6	7	4	8	4	12
	55	5.5	132S	211.5	152	132	266	108	70	265	75	27	120	197	256	180	89	80	63	239	φ38k6	8	5	10	4	12
	75	7.5		252	198	160	318	127	105	316	105	56	142	266	310	254	108	110	90	323	φ42k6	8	5	12	4	14.5
	11K	11	160M	252	198	160	318	127	105	316	105	56	142	266	310	254	108	110	90	323	φ42k6	8	5	12	4	14.5
15K	15																									

NOTE

- The drawings shown above are sample outline dimension drawings. The outer appearance may differ depending on the frame number.

Application to premium high-efficiency IPM motor [MM-THE4 (1500 r/min specification) series]

◆ Motor specification

Motor model		MM-THE4					
Voltage class		200 V		400 V			
Applicable inverter *2		FR-F820-□		FR-F840-□			
		03160(75K)	01800(75K)	02160(90K)	02600(110K)	03250(132K)	03610(160K)
Continuous characteristic *1	Rated output (kW)	75	75	90	110	132	160
	Rated torque (N·m)	477	477	573	700	840	1018
Rated speed (r/min)		1500					
Maximum speed (r/min)		1800					
Number of poles		6					
Maximum torque		120% 60 s					
Frame number		250MA	250MA	250MD	280MD		
Inertia moment J ($\times 10^{-4}$ kg·m ²)		6000	6000	10000	17500	20500	23250
Rated current (A)		270	135	170	195	230	280
Structure		Totally-enclosed fan-cooled motor. With steel framed legs. (protective structure IP44)					
Insulation class		155 (F)					
Vibration class		V25					
Environment	Surrounding air temperature and humidity	-10°C to +40°C (non-freezing) · 90%RH or less (non-condensing)					
	Storage temperature and humidity	-20°C to +70°C (non-freezing) · 90%RH or less (non-condensing)					
	Atmosphere	Indoors (not under direct sunlight), and free from corrosive gas, flammable gas, oil mist, dust and dirt.					
	Altitude	Maximum 1000 m					
	Vibration	4.9 m/s ²					
Mass (kg)		470	470	610	780	810	860

*1 Output and rated motor speed are not guaranteed when the power supply voltage drops.

*2 For the LD rating

◆ Motor torque characteristic

The following figure shows the torque characteristic of the premium high-efficiency IPM motor [MM-THE4] when used with an inverter.

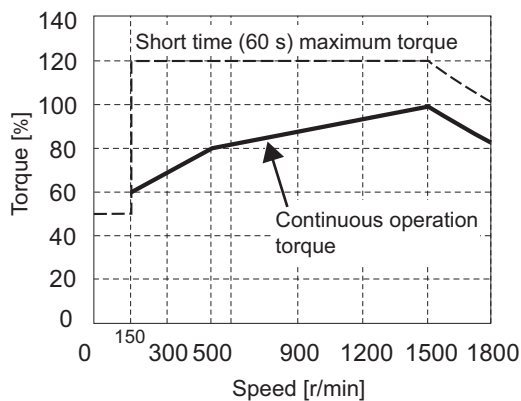

NOTE

- The motor can also be used for applications which require the rated speed of 1800 r/min.
- The torque characteristic is when the armature winding temperature is 20°C, and the input voltage to the inverter is 200 VAC or 400 VAC.
- Constant-speed operation cannot be performed for the speed of 150 r/min or less.

◆ Motor outline dimensions

• 75 kW

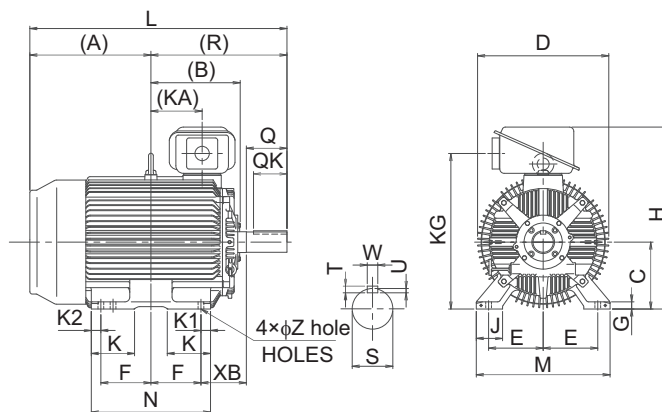

Frame No.	Outline dimension (mm)																									
	A	B	C	D	E	F	G	H	J	KA	KG	K	K1	K2	L	M	N	Z	XB	Q	QK	R	S	T	U	W
250MA	449.5	317	250	490	203	174.5	30	692	100	157.5	583	168	50	50	932	486	449	24	168	140	110	482.5	75m6	12	7.5	20

• 90 kW

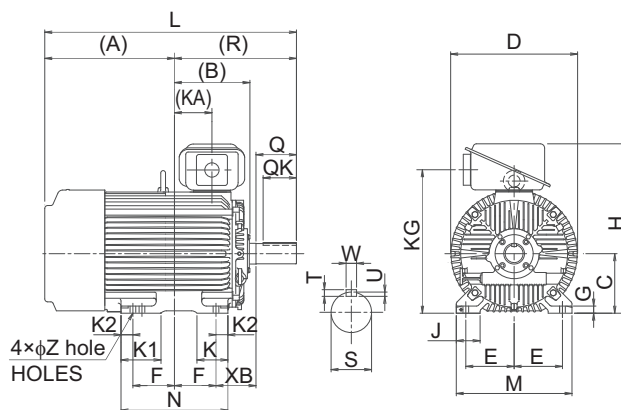

Frame No.	Outline dimension (mm)																									
	A	B	C	D	E	F	G	H	J	KA	KG	K	K1	K2	L	M	N	Z	XB	Q	QK	R	S	T	U	W
250MD	545.5	317	250	535	203	174.5	30	712	100	157.5	603	130	168	50	1028	486	449	24	168	140	110	482.5	75m6	12	7.5	20

• 110 kW, 132 kW, 160 kW

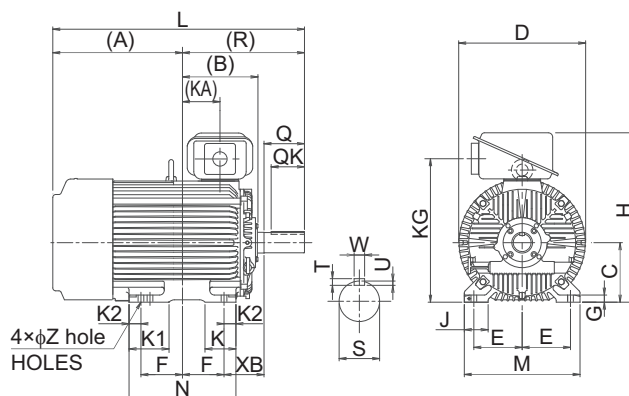

Frame No.	Outline dimension (mm)																									
	A	B	C	D	E	F	G	H	J	KA	KG	K	K1	K2	L	M	N	Z	XB	Q	QK	R	S	T	U	W
280MD	596.5	374	280	587	228.5	209.5	30	782	110	210.5	673	130	181	40	1166	560	499	24	190	170	140	569.5	85m6	14	9	22

NOTE

- The drawings shown above are sample outline dimension drawings. The outer appearance may differ depending on the frame number.
- For the 200 V class, models with capacities up to 75 kW are available.

● PM motor control, PM parameter initial setting

Performing the IPM parameter initialization makes the IPM motor MM-EFS, MM-THE4 ready for PM motor control.

PM motor control requires the following conditions.

- The motor capacity is equal to or one rank lower than the inverter capacity.
- Single-motor operation (one motor to one inverter) is preformed.
- The overall wiring length with the motor is 100 m or shorter. (Even with the IPM motor MM-EFS, MM-THE4, when the wiring length exceeds 30 m, perform offline auto tuning.)

◆ Setting procedure of PM motor control







◆ Selecting the PM motor control by the IPM initialization mode

This inverter is set for an induction motor in the initial setting. Follow the following procedure to change the setting for the PM motor control.

POINT

- The parameters required to drive an MM-EFS, MM-THE4 IPM motor are automatically changed as a batch.
- To change to the PM motor control, perform the following steps before setting other parameters. If the PM motor control is selected after setting other parameters, some of those parameters will be initialized too. (Refer to "PM parameter initialization list" for the parameters that are initialized.)

Operation

1.	Screen at power-ON The monitor display appears.
2.	Changing the operation mode Press  to choose the PU operation mode. [PU] indicator is lit.
3.	Parameter setting mode Press  to choose the parameter setting mode. [PRM] indicator is lit.
4.	IPM parameter initialization Turn  until "I PM" (IPM parameter initialization) appears.
5.	Setting value display Press  to read the present set value. "0" (initial value) appears.
6.	Changing the setting value Turn  to change the set value to "12", then press  . "12" and "I PM" flicker alternately. The setting is completed.

Setting value	Description
0	Parameter settings for an induction motor
12	Parameter settings for a premium high-efficiency IPM motor (rotations per minute) (MM-EFS (1500 r/min specification), MM-THE4)
14	Parameter settings for a premium high-efficiency IPM motor (rotations per minute) (MM-EFS (3000 r/min specification))

NOTE

- Performing IPM parameter initialization in the parameter setting mode automatically changes the **Pr.998 PM parameter initialization** setting.
- In the initial parameter setting, the capacity same as the inverter capacity is set in **Pr.80 Motor capacity**. To use a motor capacity that is one rank lower than the inverter capacity, set Motor capacity by selecting the mode on the operation panel.
- To set a speed or to display monitored items in frequency, set **Pr.998**. (Refer to Instruction Manual (Detailed).)

◆ Selecting the PM sensorless vector control by Pr.998

- Setting **Pr.998 PM parameter initialization** as shown in the following table activates PM motor control.

Pr.998 setting	Description	Operation on IPM parameter initialization
0 (initial value)	Parameter settings for an induction motor (frequency)	"I PM"(IPM) → write "0"
12	Parameter settings for a premium high-efficiency IPM motor (rotations per minute) (MM-EFS (1500 r/min specification), MM-THE4)	"I PM"(IPM) → write "12"
14	Parameter settings for a premium high-efficiency IPM motor (rotations per minute) (MM-EFS (3000 r/min specification))	"I PM"(IPM) → write "14"
112	Parameter settings for a premium high-efficiency IPM motor (frequency) (MM-EFS (1500 r/min specification), MM-THE4)	-
114	Parameter settings for a premium high-efficiency IPM motor (frequency) (MM-EFS (3000 r/min specification))	-
8009	Parameter (rotations per minute) settings for an IPM motor other than MM-EFS, MM-THE4 (after tuning)	-
8109	Parameter (frequency) settings for an IPM motor other than MM-EFS, MM-THE4 (frequency)	-
9009	Parameter (rotations per minute) settings for an SPM motor (after tuning)	-
9109	Parameter (frequency) settings for an SPM motor (after tuning)	-

NOTE

- The S-PM geared motor cannot be driven.

◆ PM parameter initialization list

- The parameter settings in the following table are changed to the settings required to perform PM motor control by selecting PM motor control with the IPM parameter initialization mode on the operation panel or with **Pr.998 PM parameter initialization**.
- Performing parameter clear or all parameter clear sets back the parameter settings to the settings required to drive an induction motor.

Pr.	Name	Setting						Setting increments	
		Induction motor		PM motor (rotations per minute)		PM motor (frequency)		12, 8009, 9009	0, 112, 8109, 9109
		Pr.998		0 (initial value)	12 (MM-EFS, MM-THE4)	8009, 9009 (other than MM-EFS, MM-THE4)	112 (MM-EFS, MM-THE4)		
FM	CA								
1	Maximum frequency	120 Hz*1 60 Hz*2		Maximum motor rotations per minute	Maximum motor rotations per minute*6	Maximum motor frequency	Maximum motor frequency*6	1 r/min	0.01 Hz
4	Multi-speed setting (high speed)	60 Hz	50 Hz	Rated motor rotations per minute	Pr.84	Rated motor frequency	Pr.84	1 r/min	0.01 Hz
9	Electronic thermal O/L relay	Inverter rated current		Rated motor current (Refer to page 129, page 133.)	—	Rated motor current (Refer to page 129, page 133.)	—	0.01 A*1 0.1 A*2	
13	Starting frequency	0.5 Hz		Minimum rotations per minute	Pr.84 × 10%	Minimum frequency	Pr.84 × 10%	1 r/min	0.01 Hz
15	Jog frequency	5 Hz		Minimum rotations per minute	Pr.84 × 10%	Minimum frequency	Pr.84 × 10%	1 r/min	0.01 Hz
18	High speed maximum frequency	120 Hz*1 60 Hz*2		Maximum motor rotations per minute	—	Maximum motor frequency	—	1 r/min	0.01 Hz
20	Acceleration/deceleration reference frequency	60 Hz	50 Hz	Rated motor rotations per minute	Pr.84	Rated motor frequency	Pr.84	1 r/min	0.01 Hz
22	Stall prevention operation level	120%*5	110%*5	Short-time motor torque				0.1%	
37	Speed display	0		0				1	
55	Frequency monitoring reference	60 Hz	50 Hz	Rated motor rotations per minute	Pr.84	Rated motor frequency	Pr.84	1 r/min	0.01 Hz
56	Current monitoring reference	Inverter rated current		Rated motor current (Refer to page 129, page 133.)	Pr.859	Rated motor current (Refer to page 129, page 133.)	Pr.859	0.01 A*1 0.1 A*2	
71	Applied motor	0		210*3		210*3		1	
80	Motor capacity	9999		Inverter capacity*4	—	Inverter capacity*4	—	0.01 kW*1 0.1 kW*2	
81	Number of motor poles	9999		Number of motor poles*4	—	Number of motor poles*4	—	1	
84	Rated motor frequency	9999		Rated motor rotations per minute*4	—	Rated motor frequency*4	—	1 r/min	0.01 Hz
125 (903)	Terminal 2 frequency setting gain frequency	60 Hz	50 Hz	Rated motor rotations per minute	Pr.84	Rated motor frequency	Pr.84	1 r/min	0.01 Hz
126 (905)	Terminal 4 frequency setting gain frequency	60 Hz	50 Hz	Rated motor rotations per minute	Pr.84	Rated motor frequency	Pr.84	1 r/min	0.01 Hz
144	Speed setting switchover	4		Number of motor poles + 100	Pr.81 + 100	Number of motor poles	Pr.81	1	
240	Soft-PWM operation selection	1		0				1	
263	Subtraction starting frequency	60 Hz	50 Hz	Rated motor rotations per minute	Pr.84	Rated motor frequency	Pr.84	1 r/min	0.01 Hz
266	Power failure deceleration time switchover frequency	60 Hz	50 Hz	Rated motor rotations per minute	Pr.84	Rated motor frequency	Pr.84	1 r/min	0.01 Hz
374	Overspeed detection level	9999		Overspeed detection level, rotations per minute	Maximum motor rotations per minute + 10 Hz*6*7	Overspeed detection level, frequency	Maximum motor frequency + 10 Hz*6	1 r/min	0.01 Hz
390	% setting reference frequency	60 Hz	50 Hz	Rated motor rotations per minute	Pr.84	Rated motor frequency	Pr.84	1 r/min	0.01 Hz
505	Speed setting reference	60 Hz	50 Hz	Rated motor frequency	Pr.84	Rated motor frequency	Pr.84	0.01 Hz	
557	Current average value monitor signal output reference current	Inverter rated current		Rated motor current (Refer to page 129, page 133.)	Pr.859	Rated motor current (Refer to page 129, page 133.)	Pr.859	0.01 A*1 0.1 A*2	

Pr.	Name	Setting						Setting increments	
		Induction motor		PM motor (rotations per minute)		PM motor (frequency)			
		Pr.998	0 (initial value)		12 (MM-EFS, MM-THE4)	8009, 9009 (other than MM-EFS, MM-THE4)	112 (MM-EFS, MM-THE4)	8109, 9109 (other than MM-EFS, MM-THE4)	12, 8009, 9009
FM	CA								
870	Speed detection hysteresis	0 Hz		Speed detection hysteresis rotations per minute	0.5 Hz*7	Speed detection hysteresis frequency	0.5 Hz	1 r/min	0.01 Hz
885	Regeneration avoidance compensation frequency limit value	6 Hz		Minimum rotations per minute	Pr.84 × 10%	Minimum frequency	Pr.84 × 10%	1 r/min	0.01 Hz
893	Energy saving monitor reference (motor capacity)	Inverter rated capacity		Motor capacity (Pr.80)				0.01 kW*1	0.1 kW*2
C14 (918)	Terminal 1 gain frequency (speed)	60 Hz	50 Hz	Rated motor rotations per minute	Pr.84	Rated motor frequency	Pr.84	1 r/min	0.01 Hz

—: Not changed

- *1 Initial value for the FR-F820-02330(55K) or lower and FR-F840-01160(55K) or lower
- *2 Initial value for the FR-F820-03160(75K) or higher and FR-F840-01800(75K) or higher
- *3 Setting **Pr.71 Applied motor** = "213, 214, 8093, 8094, 9093, or 9094" does not change the **Pr.71** setting.
- *4 When a value other than "9999" is set, the set value is not changed.
- *5 110% for SLD, 120% for LD
- *6 **Pr.702 Maximum motor frequency** is used as the maximum motor frequency (rotations per minute). When **Pr.702** = "9999 (initial value)", **Pr.84 Rated motor frequency** is used as the maximum motor frequency (rotations per minute).
- *7 The setting value is converted from frequency to rotations per minute. (The value after the conversion differs according to the number of motor poles.)

NOTE

- If IPM parameter initialization is performed in rotations per minute (**Pr.998** = "3003, 8009, or 9009"), the parameters not listed in the table and the monitored items are also set and displayed in rotations per minute.

◆ IPM motor specification list

	MM-EFS (1500 r/min specification) (15 kW or lower)	MM-EFS (1500 r/min specification) (18.5 kW to 55 kW)	MM-THE4 (75 kW to 160 kW)	MM-EFS (3000 r/min specification) (15 kW or lower)
Rated motor frequency (rotations per minute)	75 Hz (1500 r/min)	100 Hz (1500 r/min)	75 Hz (1500 r/min)	150 Hz (3000 r/min)
Maximum motor frequency (rotations per minute)	112.5 Hz (2250 r/min)	150 Hz (2250 r/min)	90 Hz (1800 r/min)	200 Hz (4000 r/min)
Number of motor poles	6	8	6	6
Short-time motor torque	110% for SLD, 120% for LD			110% for SLD, 120% for LD
Minimum frequency (rotations per minute)	7.5 Hz (150 r/min)	10 Hz (150 r/min)	7.5 Hz (150 r/min)	15 Hz (300 r/min)
Speed detection hysteresis frequency (rotations per minute)	0.5 Hz (10 r/min)	0.5 Hz (8 r/min)	0.5 Hz (10 r/min)	0.5 Hz (10 r/min)
Overspeed detection level, frequency (rotations per minute)	122.5 Hz (2450 r/min)	160 Hz (2400 r/min)	100 Hz (2000 r/min)	210 Hz (4200 r/min)

◆ Specification comparison between the PM motor control and the induction motor control

Item		PM motor control	Induction motor control
Applicable motor		Premium high-efficiency IPM motor MM-EFS or MM-THE4 series (the same capacity as the inverter capacity)	General-purpose motor SF-JR, SF-PR series, etc.*1
Number of connectable motors		1: 1	Several motors can be driven under V/F control.
Number of motor poles		MM-EFS (1500 r/min specification) 15 kW or lower: 6 poles MM-EFS (1500 r/min specification) 18.5 kW or higher: 8 poles MM-EFS (3000 r/min specification): 6 poles MM-THE4: 6 poles	Normally 2, 4, or 6 poles.
Rated motor frequency		MM-EFS (1500 r/min specification) 15 kW or lower: 75 Hz MM-EFS (1500 r/min specification) 18.5 kW or higher: 100 Hz MM-EFS (3000 r/min specification): 150 Hz MM-THE4: 75 Hz	Normally 50 Hz or 60 Hz
Maximum output frequency		MM-EFS (1500 r/min specification) 15 kW or lower: 112.5 Hz MM-EFS (1500 r/min specification) 18.5 kW or higher: 150 Hz MM-EFS (3000 r/min specification): 200 Hz MM-THE4: 90 Hz	590 Hz (17700 r/min with 4P) (Set the upper limit frequency (Pr.1, Pr.18) according to the motor and machine specifications.)
Permissible load		120% 60 s, 150% 3 s (inverse-time characteristics) (The % value is a ratio to the rated motor current.)	120% 60 s, 150% 3 s (inverse-time characteristics) (The % value is a ratio to the inverter rated current.)
Maximum starting torque		50%	120% (Advanced magnetic flux vector control)
Frequency setting and resolution (based on the motor rating)	Terminals 2 and 4 (0 to 10 V / 12 bits)	MM-EFS (1500 r/min specification) 15 kW or lower*2 and MM-THE4: 0.018 Hz MM-EFS (1500 r/min specification) 18.5 kW or higher*2: 0.025 Hz MM-EFS (3000 r/min specification): 0.036 Hz	0.015 Hz (60 Hz rating)
	Terminals 2 and 4 (0 to 5 V / 11 bits or 0 to 20 mA / 11 bits) Terminal 1 (0 to ±10 V / 12 bits)	MM-EFS (1500 r/min specification) 15 kW or lower*2 and MM-THE4: 0.036 Hz MM-EFS (1500 r/min specification) 18.5 kW or higher*2: 0.050 Hz MM-EFS (3000 r/min specification): 0.072 Hz	0.03 Hz (60 Hz rating)
	Terminal 1 (0 to ±5 V / 11 bits)	MM-EFS (1500 r/min specification) 15 kW or lower*2 and MM-THE4: 0.072 Hz MM-EFS (1500 r/min specification) 18.5 kW or higher*2: 0.100 Hz MM-EFS (3000 r/min specification): 0.144 Hz	0.06 Hz (60 Hz rating)
Output signal	Pulse output for meter	In the initial setting, 1 mA is output at the rated motor frequency from across terminals FM and SD. (SD is a common terminal.) The permissible frequency load current is 2 mA. Pulse specification: 1440 pulses/s at the rated motor frequency	In the initial setting, 1 mA is output at 60 Hz from across terminals FM and SD. (SD is a common terminal.) The permissible frequency load current is 2 mA. Pulse specification: 1440 pulses/s at 60 Hz
Carrier frequency		Four patterns of 2 kHz, 6 kHz, 10 kHz, and 14 kHz*3 Two patterns of 2 kHz and 6 kHz*4	Selectable from 0.75 kHz to 14.5 kHz*3 0.75 kHz to 6 kHz*4
Automatic restart after instantaneous power failure		No startup delay time. Using the regeneration avoidance function together is recommended.	Startup waiting time exists.
Startup delay		Startup delay of about 0.1 s for initial tuning.	No startup delay.
Driving by the commercial power supply		Not available. Never connect an IPM motor to the commercial power supply.	Can be driven by the commercial power supply.
Operation during coasting		While the motor is coasting, an electrical potential is generated across motor terminals. Before wiring, make sure that the motor is stopped.	While the motor is coasting, no potential is generated across motor terminals.
Maximum motor wiring length		100 m or shorter	Overall length: 500 m or shorter

- *1 Select a motor with the rated current equal to or less than the inverter rated current. (It must be 0.4 kW or higher.)
If a motor with substantially low rated current compared with the inverter rated current is used, speed and torque accuracies may deteriorate due to torque ripples, etc. Set the rated motor current to about 40% or higher of the inverter rated current.
- *2 For the MM-EFS (1500 r/min specification), the number of motor poles differs between the 15 kW or lower motor (6 poles) and the 18.5 kW or higher motor (8 poles). For this reason, the frequency setting resolution also differs between them.
- *3 For the FR-F820-02330(55K) or lower and FR-F840-01160(55K) or lower.
- *4 For the FR-F820-03160(75K) or higher and FR-F840-01800(75K) or higher.

NOTE

- Before wiring, make sure that the motor is stopped. Otherwise you may get an electric shock.
- Never connect an IPM motor to the commercial power supply.
- No slippage occurs with an IPM motor because of its characteristic. If an IPM motor, which took over an induction motor, is driven at the same speed as for the general-purpose motor, the running speed of the IPM motor becomes faster by the amount of the general-purpose motor's slippage. Adjust the speed command to run the IPM motor at the same speed as the induction motor, as required.

● Countermeasures against deterioration of the 400 V class motor insulation

When driving a 400 V class motor by the inverter, surge voltages attributable to the wiring constants may occur at the motor terminals, deteriorating the insulation of the motor. When the 400 V class motor is driven by the inverter, consider the following countermeasures:

◆ With induction motor

It is recommended to take one of the following countermeasures:

◆ Rectifying the motor insulation and limiting the PWM carrier frequency according to the wiring length

For the 400 V class motor, use an insulation-enhanced motor.

(The Mitsubishi Electric high-efficiency motor SF-HR, the Mitsubishi Electric constant-torque motor SF-HRCA, and the Mitsubishi Electric high-performance, energy-saving motor SF-PR are insulation-enhanced motors as standard.)

Specifically,

- Order a "400 V class inverter-driven insulation-enhanced motor".
- For the dedicated motor such as the constant-torque motor and low-vibration motor, use an "inverter-driven dedicated motor".
- Set **Pr.72 PWM frequency selection** as indicated below according to the wiring length.

Inverter	Wiring length 50 m or shorter	Wiring length 50 m to 100 m	Wiring length Longer than 100 m
Standard model	15 (14.5 kHz) or lower	9 (9 kHz) or lower	4 (4 kHz) lower
Separated converter type	6 (6 kHz) or lower	6 (6 kHz) or lower	4 (4 kHz) lower

◆ Suppressing the surge voltage on the inverter side

- For FR-F840-01160(55K) or lower, connect a surge voltage suppression filter (FR-ASF-H/FR-BMF-H) at the output side of the inverter.
- For FR-F840-01800(75K) or higher, connect a sine wave filter (MT-BSL/BSC) at the output side of the inverter.

◆ With PM motor

When the wiring length exceeds 50 m, set "9" (6 kHz) or less in **Pr.72 PWM frequency selection**.



- A surge voltage suppression filter (FR-ASF-H/FR-BMF-H) can be used under V/F control and Advanced magnetic flux vector control. A sine wave filter (MT-BSL/BSC) can be used under V/F control. Do not use the filters under different control.

● Application to special motors

◆ Motors with brake

Use the motor with brake having independent power supply for the brake, connect the brake power supply to the inverter primary side power and make the inverter output off using the output stop terminal (MRS) when the brake is applied (motor stop). Rattle may be heard according to the type of the brake in the low speed region but it is not a fault.

◆ Pole changing motor

As this motor differs in rated current from the standard motor, confirm the maximum current of the motor and select the inverter. Be sure to change the number of poles after the motor has stopped. If the number of poles is changed during rotation, the regenerative overvoltage protection circuit may be activated to cause an inverter alarm, coasting the motor to a stop.

◆ Geared motor

The continuous operating rotation range of this motor changes depending on the lubrication system and maker. Especially in the case of oil lubrication, continuous operation in the low-speed range only can cause gear seizure. For fast operation at higher than 60 Hz, please consult the motor maker.

◆ Synchronous motor other than PM motor

This motor is not suitable for applications of large load variation or impact, where out-of-sync is likely to occur. Please contact your sales representative when using this motor because its starting current and rated current are greater than those of the standard motor and will not rotate stably at low speed.

◆ Single phase motor

The single phase motor is not suitable for variable operation by the inverter.

For the capacitor starting system, the capacitor may be damaged due to harmonic current flowing to the capacitor. For the split-phase starting system and repulsion starting system, not only output torque is not generated at low speed but it will result in starting coil burnout due to failure of centrifugal force switch inside. Replace with a three-phase motor for use.

Compatibility

● Differences with the FR-F700(P) series

Item	FR-F700(P)	FR-F800
Control method	V/F control Simple magnetic flux vector control IPM motor control	V/F control Advanced magnetic flux vector control PM motor control (IPM motor/SPM motor)
Added functions	—	USB host function Safety stop function PLC function etc.
Maximum output frequency V/F control	400 Hz	590 Hz
PID control	Turn the X14 signal ON to enable PID control.	When the X14 signal is not assigned, just set a value in Pr.128 to enable PID control. When the X14 signal is assigned, turn the X14 signal ON while Pr.128 ≠ "0" to enable PID control. The PID pre-charge function and dancer control are added.
Automatic restart after instantaneous power failure	Turn the CS signal ON to enable restart. Pr.186 CS terminal function selection initial value "6"	CS signal assignment not required. (Restart is enabled with the Pr.57 setting only.) Pr.186 CS terminal function selection initial value "9999"
PTC thermistor input	Input from the terminal AU (The function of the terminal AU is switched by a switch.)	Input from the terminal 2. (The function of the terminal 2 is switched by the Pr.561 setting.)
USB connector	Not used	USB host: A connector USB device: mini B connector
Main circuit terminal screw size	Terminals R/L1, S/L2, T/L3, U, V, W: Same for all capacities Terminals P/+, N/-, P1: Same except for the 400 V class 01800(75K) (FR-F740(P)-01800(75K): M10, FR-F840-01800(75K): M8) Screws for earthing (grounding): Same except for the 200 V class 03160(75K) (FR-F720(P)-03160(75K): M10, FR-F820-03160(75K): M8)	
Control circuit terminal block	Removable terminal block (screw type)	Removable terminal block (spring clamp type)
Terminal response level	The FR-F800's I/O terminals have better response level than the FR-F700(P)'s terminals. By setting Pr.289 Inverter output terminal filter and Pr.699 Input terminal filter , the terminal response level can be compatible with that of FR-F700(P). Set to approximately 5 to 8 ms and adjust the setting according to the system.	
PU	FR-DU07 (4-digit LED) FR-PU07	FR-DU08 (5-digit LED) FR-LU08 (LCD) FR-PU07 (Some functions, such as parameter copy, are unavailable.): Some functions are limited. FR-DU07 is not supported.
Plug-in option	Dedicated plug-in options (not interchangeable)	
	One plug-in option can be mounted.	Up to three plug-in options can be mounted.
Installation size	Installation size is compatible for standard models. (Replacement between the same capacities does not require new mounting holes. However, for the 200 V class 03160(75K), the installation interchange attachment (FR-F8AT) is required.) For separated converter types, installation size is not compatible. (New mounting holes are required.)	
Converter	Built-in for all capacities	An optional converter unit (FR-CC2) is required for separated converter types.
DC reactor	The 75K or higher comes with a DC reactor (FR-HEL).	For the FR-F820-03160(75K) or higher, the FR-F840-01800(75K) or higher, select a DC reactor suitable for the applicable motor capacity. (A DC reactor is not included.) Separated converter types (converter unit FR-CC2) have a built-in DC reactor.
Brake unit (75 kW or higher)	FR-BU2, MT-BU5	FR-BU2

◆ Installation precautions

- Removal procedure of the front cover is different. (Refer to the Instruction Manual of each inverter.)
- Plug-in options of the FR-A700 series are not compatible.
- Operation panel (FR-DU07) cannot be used.

◆ Wiring precautions

- The spring clamp type terminal block has changed to the screw type. Use of blade terminals is recommended.

◆ Instructions for continuous use of the PU07 (parameter unit) manufactured in September 2015 or earlier

- For the FR-F800 series, many functions (parameters) have been added. When setting these parameters, the parameter names and setting ranges are not displayed.
- Only the parameter with the numbers up to "999" can be read and set. The parameters with the numbers after "999" cannot be read or set.
- Many protective functions have been added for the FR-F800 series. These functions are available, but all faults are displayed as "Fault". When the fault history is checked, "ERR" appears. Added faults will not appear on the parameter unit. (However, MT1 to MT3 are displayed as MT.)
- Parameter copy/verification function are not available.

For information on the restrictions of the latest-version FR-PU07, refer to the Instruction Manual of the latest-version FR-PU07.

◆ Copying parameter settings

- The FR-F700(P) series' parameter settings can be easily copied to the FR-F800 series by using the setup software (FR Configurator2). (Not supported by the setup software FR-SW3-SETUP or older.)

● Comparison with the FR-F700(P) series in functions

Parameter/function	Main difference from F700(P)			Remarks
	Addition	Modification	Related parameter	
Maximum frequency		○	Pr.1 etc.	Max. 590 Hz (Max. 400 Hz under other than V/F control)
Free thermal (electronic thermal O/L relay)	○		Pr.600 to Pr.604, Pr.692 to Pr.696	Thermal characteristics can be freely set.
PTC thermistor	○		Pr.561	The protection level can be set by parameters.
Increased magnetic excitation deceleration	○		Pr.660 to Pr.662	Loss of the motor is increased to reduce regenerative power.
4 mA input check	○		Pr.573, Pr.777, Pr.778	Loss of 4 mA input is detected.
Input terminal filter	○		Pr.699	The terminal response can be adjusted.
Output terminal filter	○		Pr.289	The terminal response can be adjusted.
Remote output terminal (analog)	○		Pr.655 to Pr.659	Optional analog output
Parameter display by group	○		Pr.Md	The parameters are displayed in the conventional numerical order in the initial state.
Traverse function	○		Pr.592 to Pr.597	
USB host (USB memory connection)	○		Pr.1049	Parameter read/copy, data logging, execution of the ladder in the USB (PLC function), etc.
Second PID control	○		Pr.753 to Pr.758, Pr.1134, Pr.1135, Pr.1140, Pr.1141, Pr.1143 to Pr.1149	
PID pre-charge function	○		Pr.760 to Pr.769	
Multi-pump function	○		Pr.575 to Pr.591	
PLC function	○		Pr.414 to Pr.417, Pr.498, Pr.1150 to Pr.1199	
Maintenance timer		○	Pr.503, Pr.504, Pr.686 to Pr.689	The number of maintenance timers is increased from 1 to 3.
Multiple rating selection	○		Pr.570	The rating can be selected from SLD, or LD.
24 V external power supply input	○		—	Operation is unavailable. (Communication and parameter setting are available.)
Cooling fan operation selection		○	Pr.244	Waiting time at stop can be changed.
Retry function		○	Pr.65 to Pr.69	The retry target faults are added.
Auto tuning	○		Pr.96	
Emergency drive	○		Pr.514, Pr.515, Pr.523, Pr.524, Pr.1013	
GOT automatic recognition	○		—	The GOT2000 series is supported.
BACnet MS/TP	○		Pr.726 to Pr.729	
Load characteristics measurement/fault detection	○		Pr.1480 to Pr.1492	
PID gain tuning	○		Pr.1211 to Pr.1219	
Advanced magnetic flux vector control	○		Pr.80, Pr.81, Pr.800	
Advanced optimum excitation control	○		Pr.60, Pr.80, Pr.81, Pr.800	
Self power management	○		Pr.30, Pr.137, Pr.248, Pr.254	
PID control enhanced functions	○		Pr.111, Pr.1361 to Pr.1381	
Ethernet communication	○		Pr.1124, Pr.1125, Pr.1424 to Pr.1429, Pr.1431, Pr.1432, Pr.1434 to Pr.1455	FR-F800-E

● Differences between the standard model (FR-F840) and the separated converter type (FR-F842)

Item	FR-F842	Remarks (FR-F840)
Pr.30 Regenerative function selection	Setting ranges "2, 10, 11, 102, 110, 111" Initial value "10"	Setting ranges "0 to 2, 10, 11, 20, 21, 100, 101, 110, 111, 120, 121" Initial value "0"
Monitor function (Pr.52, Pr.54, Pr.158, Pr.774 to Pr.776, Pr.992, Pr.1027 to Pr.1034)	Emergency drive status Without (Unacceptable)	
Input terminal function selection (Pr.178 to Pr.189)	DC feeding operation permission (X70), DC feeding cancel (X71), Emergency drive execution command (X84) Without (Unacceptable)	
Pr.187 MRS terminal function selection	Initial value "10" (X10)	Initial value "24" (MRS)
Output terminal function assignment selection (Pr.190 to Pr.196, Pr.313 to Pr.322)	Instantaneous power failure/undervoltage (IPF), Emergency drive in operation (Y65), Fault output during emergency drive (Y66), DC current feeding (Y85), Main circuit capacitor life (Y87), Inrush current limit circuit life (Y89) Without (Unacceptable)	
Pr.192 IPF terminal function selection	Initial value "9999" (No function)	Initial value "2" (IPF)
Inrush current limit circuit life display, Main circuit capacitor life display (Pr.256, Pr.258, Pr.259)	Without the parameter	
Emergency drive function (Pr.514, Pr.515, Pr.523, Pr.524, Pr.1013)	Without the parameter	
Pr.599 X10 terminal input selection	Initial value "1" (N/C contact specifications)	Initial value "0" (N/O contact specifications)
Pr.872 Input phase loss protection selection	Without the parameter	
Warning, protective functions	Emergency drive in operation (ED), Instantaneous power failure (E.IPF), Undervoltage (E.UVT), Input phase loss (E.ILF), Inrush current limit circuit fault (E.IOH) Not available	

● Differences between the standard model (FR-F840) and the IP55 compatible model (FR-F846)

Item	FR-F840	FR-F846
Protective structure	Enclose type (IP20): FR-F840-00620(30K) or lower Open type (IP00): FR-F840-00770(37K) or higher	Dust- and water-proof type (IP55): all capacities
Multiple rating (Pr.570 Multiple rating setting)	SLD, LD (initial setting) rating (Setting range "0, 1")	Not applicable(LD rating equivalent) (None (setting unavailable))
Internal fan	Not provided	Provided
Protective function	—	Internal fan alarm (FN2), Abnormal internal temperature (E.IAH) provided
Pr.30 Regenerative function selection	Setting range "0 to 2, 10, 11, 20, 21, 100 to 102, 110, 111, 120, 121"	Setting range "0, 2, 10, 20, 100, 102, 110, 120"
Pr.71 Applied motor	Setting range "0 to 6, 13 to 16, 20, 23, 24, 40, 43, 44, 50, 53, 54, 70, 73, 74, 210, 213, 214, 240, 243, 244, 8090, 8093, 8094, 9090, 9093, 9094"	Setting range "0 to 6, 13 to 16, 20, 23, 24, 40, 43, 44, 50, 53, 54, 70, 73, 74, 8090, 8093, 8094, 9090, 9093, 9094"
Pr.998 PM parameter initialization	Setting range "0, 12, 14, 112, 114, 8009, 8109, 9009, 9109"	Setting range "0, 8009, 8109, 9009, 9109"
DC reactor	Option	Built-in
Operation panel	FR-DU08: IP40 (except for the PU connector section)	FR-DU08-01: IP55 (except for the PU connector section)

● Major differences between the FR-F800 (RS-485 communication model) and the FR-F800-E (Ethernet communication model)

Item	FR-F800 (RS-485 communication model)	FR-F800-E (Ethernet communication model)
Standard equipment	RS-485 terminals	Ethernet connector
Communication	Mitsubishi inverter protocol MODBUS RTU protocol BACnet MS/TP protocol	MODBUS/TCP protocol BACnet/IP protocol MELSOFT / FA product connection SLMP iQSS CC-Link IE Field Network Basic
Number of connectable plug-in options	3	2 (initial status)
Optional screw-type terminal block (FR-A8TR)	Can be used.	Cannot be used.

◆ CC-Link family compatible

Item	CC-Link IE <i>Field Basic</i>	CC-Link <i>ETSN</i>	CC-Link IE <i>Field</i>	CC-Link	
Compatible inverter	FR-F800-E	FR-F800	FR-F800	FR-F800	
Option	Unavailable	FR-A8NCG	FR-A8NCE	FR-A8NC	
Communication speed	100 Mbps	1 Gbps / 100Mbps	1 Gbps	10 Mbps	
Cable	Ethernet category 5 or higher	Ethernet category 5e or higher	Ethernet category 5e or higher	Dedicated cable	
Number of connectable inverters	64 (open specification)*1	121 (sum of master and slave stations)	64	42 (maximum)	
Cyclic communication	Compatible	Compatible	Compatible	Compatible	
Number of links*2	RX	64	64	64	
	RY	64	64	64	
	RWr	32 (64 bytes)	128 (256 bytes)	128 (256 bytes)	32 (64 bytes)
	RWw	32 (64 bytes)	128 (256 bytes)	128 (256 bytes)	32 (64 bytes)
Combination with TCP/IP	Supported	Supported	Not supported	Not supported	
Topology	Star	Line, star, ring, line-star	Line, star, ring, line-star	Bus	

*1 The actual number of connectable inverters differs according to the setting of the master.

*2 The numbers of inverter's remote I/O devices and the addresses of inverter's remote registers are common between CC-Link and CC-Link IE Field Network Basic.

Warranty

When using this product, make sure to understand the warranty described below.

1. Warranty period and coverage

We will repair any failure or defect (hereinafter referred to as "failure") in our FA equipment (hereinafter referred to as the "Product") arisen during warranty period at no charge due to causes for which we are responsible through the distributor from which you purchased the Product or our service provider. However, we will charge the actual cost of dispatching our engineer for an on-site repair work on request by customer in Japan or overseas countries. We are not responsible for any on-site readjustment and/or trial run that may be required after a defective unit are repaired or replaced.

[Term]

The term of warranty for Product is twelve months after your purchase or delivery of the Product to a place designated by you or eighteen months from the date of manufacture whichever comes first ("Warranty Period"). Warranty period for repaired Product cannot exceed beyond the original warranty period before any repair work.

[Limitations]

- (1) You are requested to conduct an initial failure diagnosis by yourself, as a general rule. It can also be carried out by us or our service company upon your request and the actual cost will be charged. However, it will not be charged if we are responsible for the cause of the failure.
- (2) This limited warranty applies only when the condition, method, environment, etc. of use are in compliance with the terms and conditions and instructions that are set forth in the instruction manual and user manual for the Product and the caution label affixed to the Product.
- (3) Even during the term of warranty, the repair cost will be charged on you in the following cases;
 - 1) a failure caused by your improper storing or handling, carelessness or negligence, etc., and a failure caused by your hardware or software problem
 - 2) a failure caused by any alteration, etc. to the Product made on your side without our approval
 - 3) a failure which may be regarded as avoidable, if your equipment in which the Product is incorporated is equipped with a safety device required by applicable laws and has any function or structure considered to be indispensable according to a common sense in the industry
 - 4) a failure which may be regarded as avoidable if consumable parts designated in the instruction manual, etc. are duly maintained and replaced
 - 5) any replacement of consumable parts (condenser, cooling fan, etc.)
 - 6) a failure caused by external factors such as inevitable accidents, including without limitation fire and abnormal fluctuation of voltage, and acts of God, including without limitation earthquake, lightning and natural disasters
 - 7) a failure caused by using the emergency drive function
 - 8) a failure generated by an unforeseeable cause with a scientific technology that was not available at the time of the shipment of the Product from our company
 - 9) any other failures which we are not responsible for or which you acknowledge we are not responsible for

2. Term of warranty after the stop of production

- (1) We may accept the repair at charge for another seven (7) years after the production of the product is discontinued. The announcement of the stop of production for each model can be seen in our Sales and Service, etc.
- (2) Please note that the Product (including its spare parts) cannot be ordered after its stop of production.

3. Service in overseas

Our regional FA Center in overseas countries will accept the repair work of the Product; however, the terms and conditions of the repair work may differ depending on each FA Center. Please ask your local FA center for details.

4. Exclusion of loss in opportunity and secondary loss from warranty liability

Regardless of the gratis warranty term, Mitsubishi Electric shall not be liable for compensation to:

- (1) Damages caused by any cause found not to be the responsibility of Mitsubishi Electric.
- (2) Loss in opportunity, lost profits incurred to the user by Failures of Mitsubishi Electric products.
- (3) Special damages and secondary damages whether foreseeable or not, compensation for accidents, and compensation for damages to products other than Mitsubishi Electric products.
- (4) Replacement by the user, maintenance of on-site equipment, start-up test run and other tasks.

5. Change of Product specifications

Specifications listed in our catalogs, manuals or technical documents may be changed without notice.

6. Application and use of the Product

- (1) For the use of our product, its applications should be those that may not result in a serious damage even if any failure or malfunction occurs in product, and a backup or fail-safe function should operate on an external system to product when any failure or malfunction occurs.
- (2) Our product is designed and manufactured as a general purpose product for use at general industries. Therefore, applications substantially influential on the public interest for such as atomic power plants and other power plants of electric power companies, and also which require a special quality assurance system, including applications for railway companies and government or public offices are not recommended, and we assume no responsibility for any failure caused by these applications when used. In addition, applications which may be substantially influential to human lives or properties for such as airlines, medical treatments, railway service, incineration and fuel systems, man-operated material handling equipment, entertainment machines, safety machines, etc. are not recommended, and we assume no responsibility for any failure caused by these applications when used. We will review the acceptability of the abovementioned applications, if you agree not to require a specific quality for a specific application. Please contact us for consultation.

MEMO

Mitsubishi Electric's global FA network delivers reliable technologies and security around the world.

■ Production base
 ● Development center
 ● Global FA Center
 ▲ Mechatronics showroom
 ● Mitsubishi Electric sales office

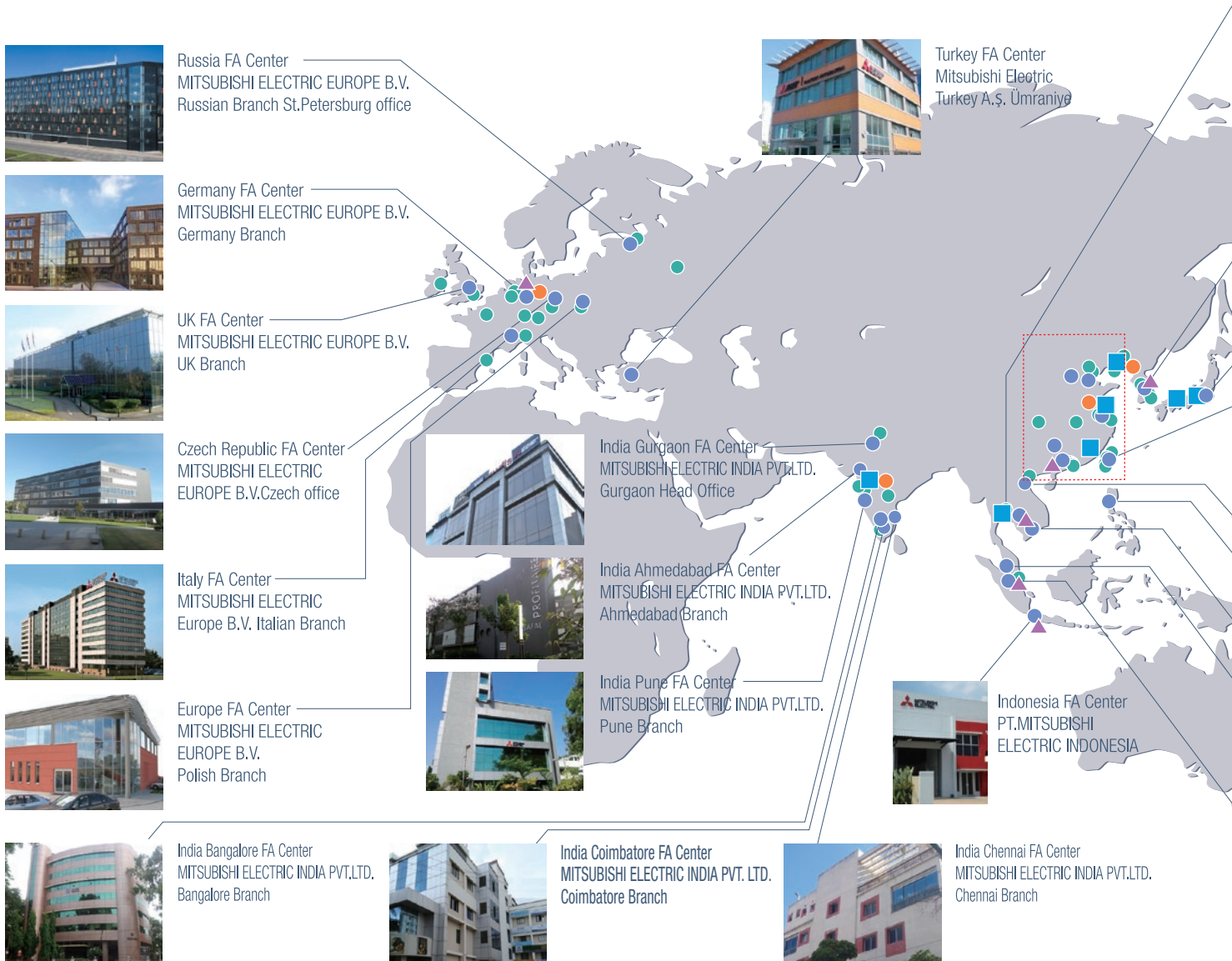

Production bases Under the lead of Nagoya Works, we form a powerful network to optimize our manufacturing processes.

Domestic bases

Nagoya Works



Shinshiro Factory
Kani Factory

Production bases overseas

MDI Mitsubishi Electric Dalian Industrial Products Co., Ltd.



MEAMC Mitsubishi Electric Automation Manufacturing (Changshu) Co., Ltd.

MEATH Mitsubishi Electric Automation (Thailand) Co., Ltd.

MEI Mitsubishi Electric India Pvt.



Thailand FA Center
MITSUBISHI ELECTRIC FACTORY
AUTOMATION (THAILAND) CO.,LTD



Korea FA Center
MITSUBISHI ELECTRIC
AUTOMATION KOREA CO.,LTD.



MITSUBISHI ELECTRIC CORPORATION
Factory Automation Systems Group



Taichung FA Center
MITSUBISHI ELECTRIC
TAIWAN CO.,LTD



Taipei FA Center
SETSUYO ENTERPRISE CO.,LTD



Philippines FA Center
MELCO FACTORY AUTOMATION
PHILIPPINES INC.



Malaysia FA Center



ASEAN FA Center
MITSUBISHI ELECTRIC
ASIA PTE.LTD.



Beijing FA Center
MITSUBISHI ELECTRIC
AUTOMATION (CHINA)



Tianjin FA Center
MITSUBISHI ELECTRIC
AUTOMATION (CHINA)



Guangzhou FA Center
MITSUBISHI ELECTRIC
AUTOMATION (CHINA)LTD.



China

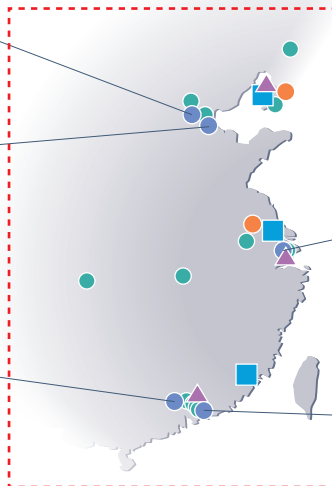

Shanghai FA Center
MITSUBISHI ELECTRIC
AUTOMATION (CHINA) LTD.

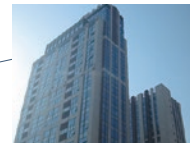

Shenzhen FA Center
MITSUBISHI ELECTRIC
AUTOMATION (CHINA) LTD.



Service bases are established around the world to provide the same services as in Japan globally. Overseas bases are opening one after another to support our customers' business expansion.

Area	Our overseas	FA centers
EMEA	39	7
China	25	4
Asia	49	16
Americas	19	6
Total	132	33

*As of March 2021

North America FA Center
MITSUBISHI ELECTRIC
AUTOMATION,INC.



Mexico Monterrey FA Center
Monterrey Office, Mitsubishi
Electric Automation, Inc.

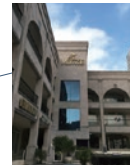

Mexico FA Center
Querétaro Office, Mitsubishi
Electric Automation, Inc.



Mexico City FA Center
Mexico FA Center
Mexico Branch, Mitsubishi
Electric Automation, Inc.



Brazil FA Center
Mitsubishi Electric do Brasil
Comércio e Serviços Ltda.



Brazil Votorantim FA Center
MELCO CNC do Brasil
Comércio e Serviços S.A.



This solution solves customers' issues and concerns by enabling visualization and analysis that lead to improvements and increase availability at production sites.

Utilizing our FA and IT technologies and collaborating with e-F@ctory Alliance partners, we reduce the total cost across the entire supply chain and engineering chain, and support the improvement initiatives and one-step-ahead manufacturing of our customers.



FA integrated solutions reduce total cost

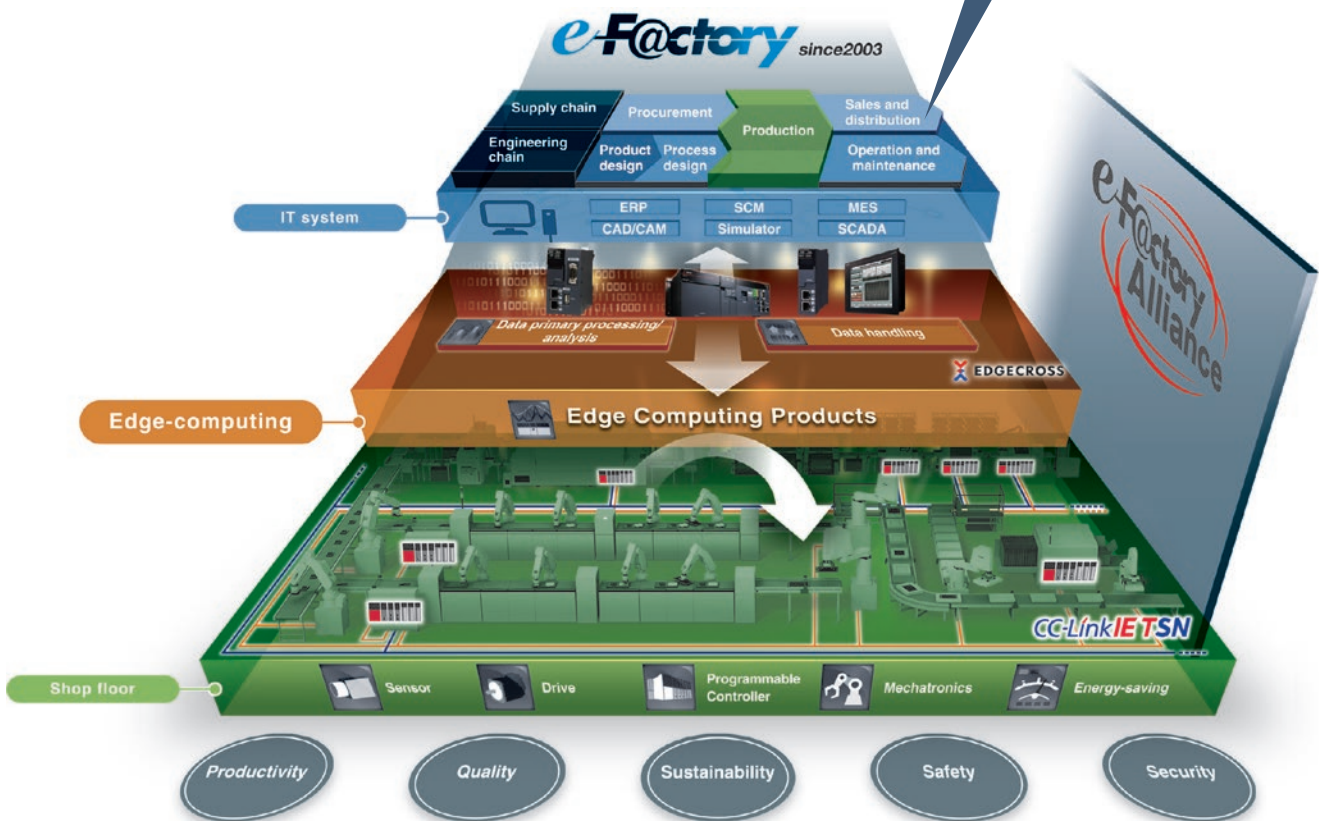
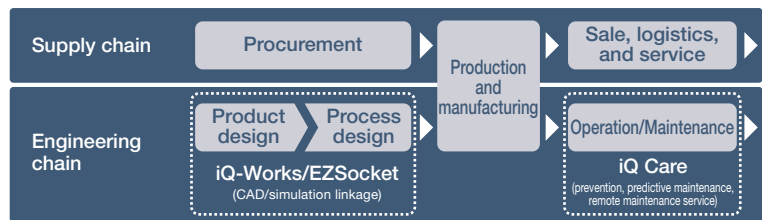

Overall production information is captured in addition to energy information, enabling the realization of efficient production and energy use (energy savings).

•Trademarks

BACnet is a registered trademark of the American Society of Heating, Refrigerating and Air-Conditioning Engineers (ASHRAE).
 PROFIBUS is a registered trademark of PROFIBUS & PROFINET International.
 MODBUS is a registered trademark of SCHNEIDER ELECTRIC USA, INC.
 Windows is a registered trademark of Microsoft Corporation in the United States and other countries.
 Other company and product names herein are the trademarks and registered trademarks of their respective owners.

YOUR SOLUTION PARTNER

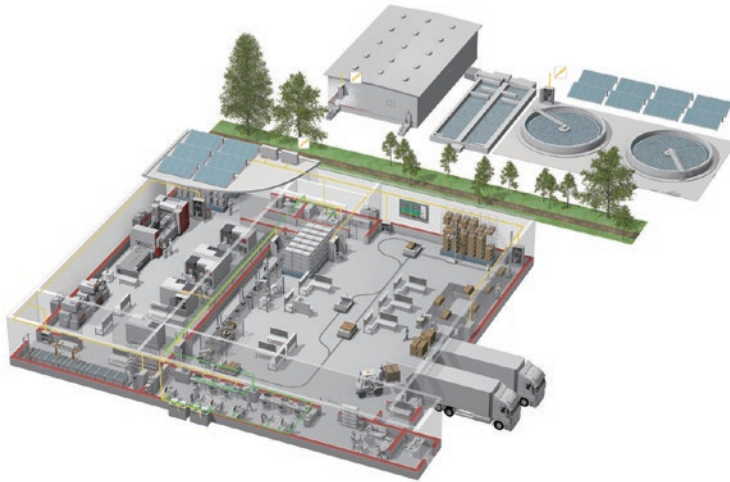

Mitsubishi Electric offers a wide range of automation equipment from PLCs and HMIs to CNC and EDM machines.

A NAME TO TRUST

Since its beginnings in 1870, some 45 companies use the Mitsubishi name, covering a spectrum of finance, commerce and industry.

The Mitsubishi brand name is recognized around the world as a symbol of premium quality.

Mitsubishi Electric Corporation, established in 1921, is active in space development, transportation, semi-conductors, energy systems, communications and information processing, audio visual equipment and home electronics, building and energy management and automation systems, and has 183 factories, laboratories and offices worldwide in over 140 countries.

This is why you can rely on Mitsubishi Electric automation solution - because we know first hand about the need for reliable, efficient, easy-to-use automation and control in our own factories.

As one of the world's leading companies with a global turnover of over 4 trillion Yen (over \$40 billion), employing over 146,000 people, Mitsubishi Electric has the resource and the commitment to deliver the ultimate in service and support as well as the best products.

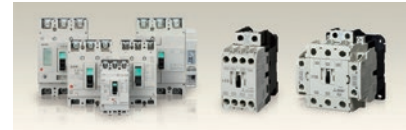

Low-voltage Power Distribution Products



Transformers, Med-voltage Distribution Products



Power Monitoring and Energy Saving Products



Power (UPS) and Environmental Products



Compact and Modular Controllers



Servos, Motors and Inverters



Visualization: HMIs



Edge Computing Products



Numerical Control (NC)



Collaborative and Industrial Robots



Processing machines: EDM, Lasers

* Not all products are available in all countries.

mitsubishi electric corporation

HEAD OFFICE: TOKYO BLDG., 2-7-3, MARUNOUCHI, CHIYODA-KU, TOKYO 100-8310, JAPAN