

Advanced servo technology with optical network

MELSERVO J3



Your partner, MR-J3

*For higher function and performance.
For more comfortable use.*

Industry leading performance

Speed frequency response of 2.1kHz



Wide range of product lines

Compatible with rotary and linear servo motor, and direct drive motor.

Ever-evolving tuning function

High level tuning with the advanced gain search function

Our Total Solution for Your Satisfaction

GOT1000



PC/AT compatible computer

FA engineering software **MELSOFT iQ Works**

Motion controller engineering environment **MELSOFT MT Works2**

Servo setup software **MR Configurator2 New**

Servo setup software **MR Configurator**

Capacity selection software

Motion controller



Q series motion controller for iQ Platform
Q173DCPU (Max. 32 axes)
Q172DCPU (Max. 8 axes)



Q series motion controller for SSCNET III
Q173HCPU (Max. 32 axes)
Q172HCPU (Max. 8 axes)



Stand alone motion controller
Q170MCPUCPU (Max. 16 axes)

Programmable controller



MELSEC Q series MELSEC L series MELSEC FX series

Positioning module



QD75MH FX3U-20SSC-H LD77MH
QD74MH

Positioning module



QD75P
QD75D
QD70P
QD70D
LD75P4
LD75D4

SSCNET III serial bus

Pulse train input

CC-Link

MR-J3-B



MR-J3-B (□) SSCNET III compatible

MR-J3-B Safety Drive Safety compatible

MR-J3W-B 2-axis servo amplifier

MR-J3-A



MR-J3-A General-purpose interface

MR-J3-T



MR-J3-T CC-Link compatible (with built-in positioning function)

Rotary servo motor

HF-KP/MP 50W to 750W



HC-LP 0.5kW to 3kW



HA-LP 5kW to 55kW



HF-SP 0.5kW to 7kW



HC-RP 1kW to 5kW



New HF-JP 0.5kW to 15kW



HC-UP 0.75kW to 5kW



Linear servo motor

LM-H2 series LM-F series New LM-K2 series LM-U2 series



Direct drive motor

TM-RFM series



INDEX

Features	p. 3
Model Designation	p. 15
Servo Motors	
Specifications and torque characteristics	p. 18
Servo motor dimensions	p. 37
Electromagnetic brake specifications	p. 49
Special shaft end specifications	p. 50
Servo Amplifiers	
MR-J3-A	
Connections with peripheral equipment	p. 51
Servo amplifier specifications	p. 52
Standard wiring diagram	p. 56
Servo amplifier dimensions	p. 63
MR-J3-B	
Connections with peripheral equipment	p. 68
Servo amplifier specifications	p. 69
Standard wiring diagram	p. 73
Servo amplifier dimensions	p. 74
MR-J3-B-RJ006	
Overview	p. 78
Servo amplifier specifications	p. 80
Connections with linear encoders	p. 82
Servo amplifier dimensions	p. 83
MR-J3-T	
Connections with peripheral equipment	p. 86
Overview	p. 87
Servo amplifier specifications	p. 91
Command and operation mode	p. 93
MR-J3-D01 specifications and dimensions	p. 94
Standard wiring diagram	p. 96
Servo amplifier dimensions	p. 98
Options	
MR-J3 basic configurations	p.101
Optional cables and connectors	p.103
Ordering information for customers	p.114
RoHS compliant connectors	p.118
Dynamic brakes	p.119
Optional regeneration units	p.120
Battery	p.124
Battery connection relay cable	p.124
Diagnostic cable	p.124
Heat sink outside attachment	p.125
Manual pulse generator	p.125
6-digit digital switch	p.125
Junction terminal blocks	p.126
Parameter unit	p.127
Peripheral Equipment	
Electrical wires, circuit breakers and magnetic contactors	p.128
Radio noise filters	p.129
Line noise filters	p.129
Data line filter	p.129
Surge killer	p.129
EMC filters	p.130
Power factor improvement reactor	p.132
MR-J3-BSafety	p.134
MR-J3W Series	p.152
Servo Support Software	p.176
Cautions	p.178
Warranty	p.183
Global FA Centers	p.184

Improving Machine Performance!

Machine performance can be substantially improved with MR-J3.

Shorter tact time

Industry leading level of control

Speed frequency response is increased to 2.1kHz*, meeting high end machine needs.

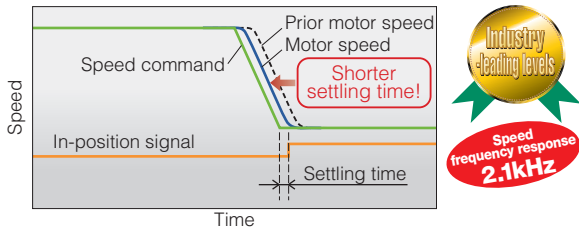

* Available with MR-J3-A/B(-RJ006)/BSafety.

Increased motor speed and torque

Since higher torque is output even at high speeds as compared to the prior model, a machine can be downsized by using 1 rank smaller servo motor. Additionally, acceleration/deceleration time can be shortened. For HF-KP series, the maximum torque is increased to 350%.

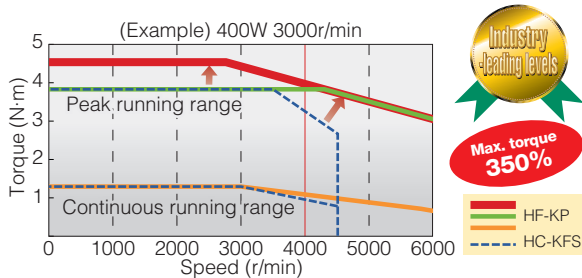

The servo motor can operate at up to 6000r/min, and thereby shortens positioning time and improves machine throughput.

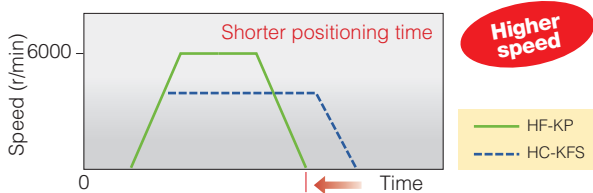

Highly accurate operation

Decreased cogging torque

Fluctuations in motor torque are reduced, realizing smooth machine operation at stable speed.

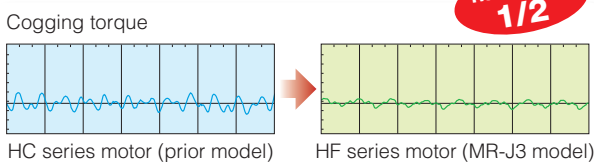

High-resolution absolute encoder

The servo motor is equipped with a 262144p/rev (18bit*) absolute encoder as a standard for highly accurate positioning. Absolute position detection system can be easily configured by mounting MR-J3BAT battery.

* Contact your local sales office for encoders higher than 18-bit resolution.

More compact

Servo amplifier

Needs 40% smaller mounting space as compared to MR-J2S series. (comparison in 400W)

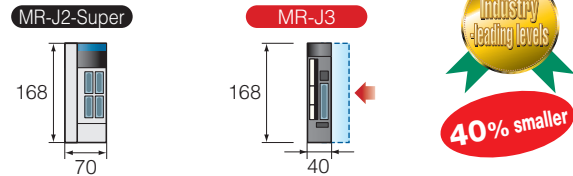

Close mounting is possible*. (200V 3.5kW or smaller)

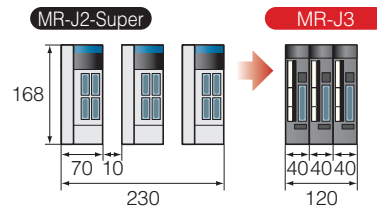

* The working environment is different for close mounting. Refer to the sections "Cautions concerning use" in this catalog for details.

Servo motor

HF-KP/HF-MP series

Motor lengths are shortened by 20%. (Comparison of HF-KP/MP and HC-KFS/MFS in 400W)



HF-SP series

The connectors of the HF-SP series are smaller than those of the HC-SFS series (prior model), so that the user's system can be made even more compact.

HF-JP series

Motor volumes are reduced by 46%. (Comparison of HF-JP and HA-LP in 11kW) Compact motor with large capacity has been realized.



Flexible wiring

Connector type available

Connectors have been adopted* for the servo amplifier terminal block thereby reducing the time required for wiring.

* Connector type is available for 200V 3.5kW or smaller and 400V 2kW or smaller servo amplifiers.

Selectable cable leading direction

Cable mounting direction is changeable according to the selected cables. (HF-KP/HF-MP series)

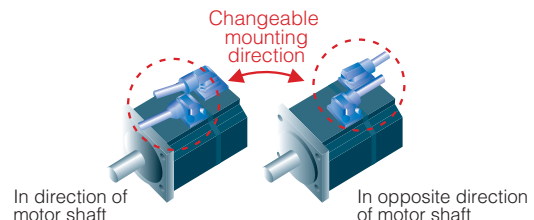

Improving Total System Dynamics!

System's fast response and reliability are realized with SSCNET III.

Fast and accurate optical communication

Improved communication speed and command communication cycle

Achieves up to 50 Mbps full duplex baud rate (equivalent to 100Mbps one way) and improves system response.

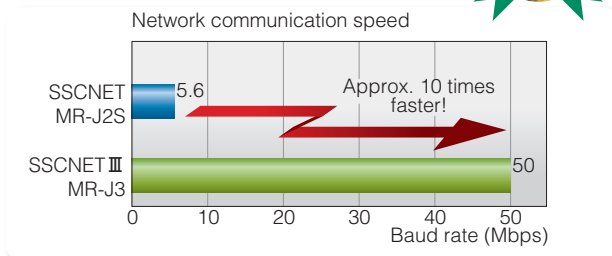

Smooth control using high-speed serial communication with cycle times as fast as 0.44ms.

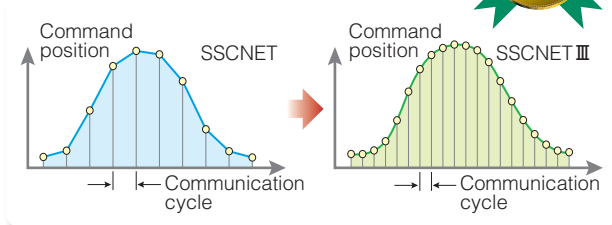

Complete synchronized communication is achieved with SSCNET III, offering technical advantages in machines such as printing and food processing machines that require synchronous accuracy.

Timing of servo amplifier processing

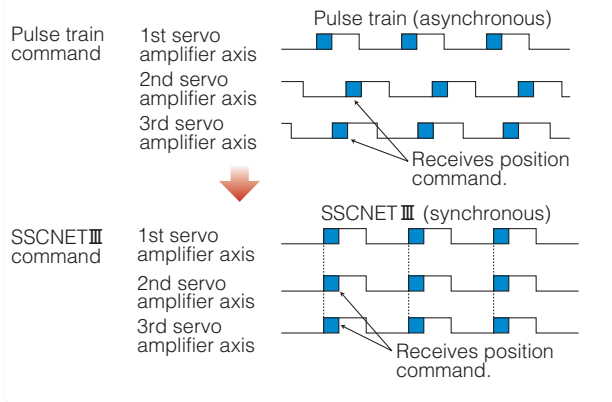

Improved noise immunity

High quality communication

The fiber-optic cables thoroughly shut out noise that enters from the power cable or external devices. Noise immunity is dramatically improved as compared to metal cables.

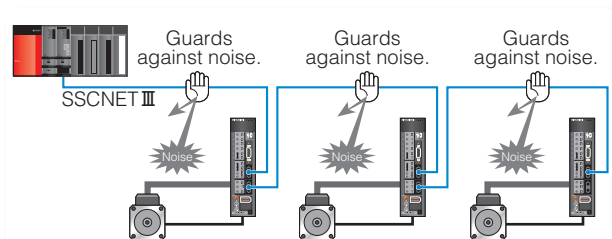

Simple and flexible wiring

Simple wiring

Simple connections with dedicated cables reduce both wiring time and chances of wiring errors. No more complicated wiring.

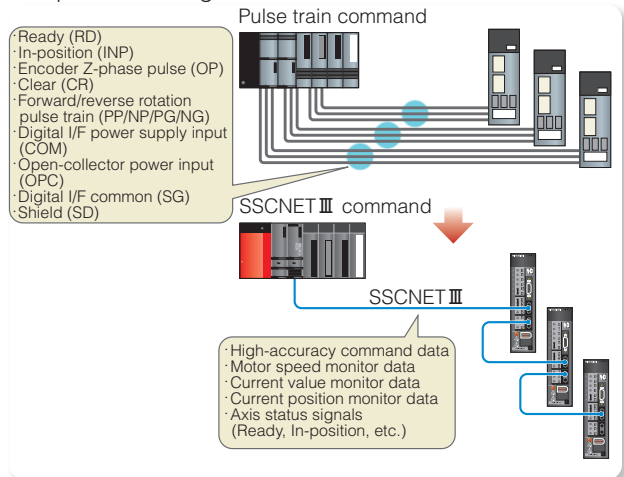

Reduced wiring is achieved by issuing the stroke limit and the proximity dog signals via the servo amplifier.

Long distance wiring

Long distance wiring is possible up to 800m per system (maximum of 50m between stations x 16 axes). Thus, it is suitable for large-scale systems.

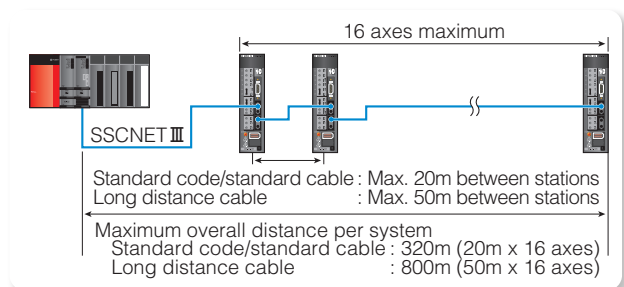

Easy data management

Bidirectional optical communication

Large amount of data can be transmitted and received between the controller and the servo amplifiers in real time. Servo monitor information can be stored in a host application and can be used for control.

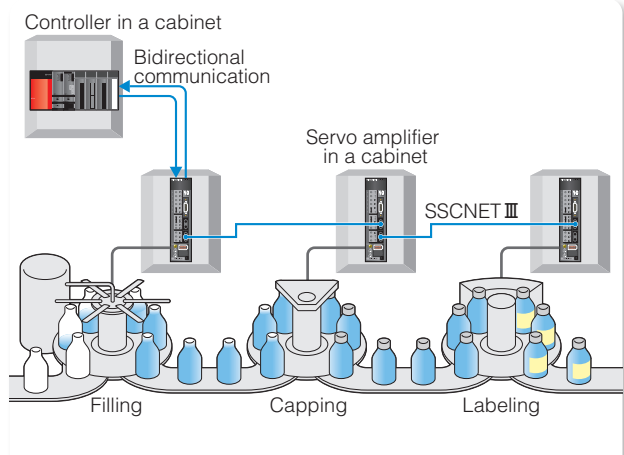

Optimal Servo Adjustment for Machines!

Easy servo adjustment for machine's maximum performance with the high control

Easy adjustment

Ever-evolving real time auto-tuning

All gains including position and speed control gains can be automatically adjusted by setting responsiveness. 32 scales of response level can be set.



Adaptive filter II

Resonance on the driving mechanism, such as a ball screw, can be suppressed automatically using this filter. Automatic adjustment range: 100Hz to 2.25kHz.

Machine resonance suppression filter setting range: 100Hz to 4.5kHz.

Optimal filters are automatically set by one-click with the auto tuning function of the MR Configurator2 or the MR Configurator. Then, these filters are automatically optimized by changing the responsiveness of the real time auto tuning.

Driving shaft vibration

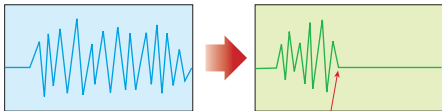

"Adaptive filter II" function ON

Optimal adjustment function for machines

Advanced vibration suppression control

An optimal filter is automatically set with the auto tuning function for suppressing 100Hz or lower frequency vibration that occurs when a driving part stops.

The auto tuning function is effective in suppressing vibration at the end of an arm and in reducing residual vibration in a machine.

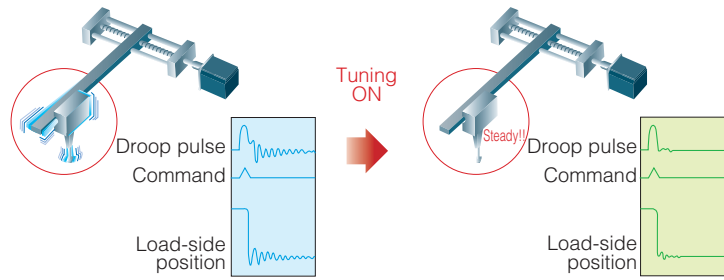

Robust disturbance compensation function

The response to a disturbance element can be increased independently of other control loop gains. This enables suppression of the disturbance while maintaining stable operations.



Effective for improving synchronous accuracy of printing and packaging machines.

(Example) Printing machine

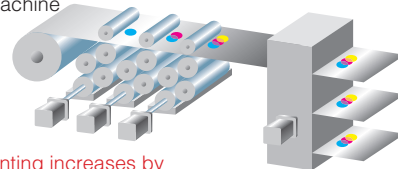

Precision of printing increases by improving synchronous accuracy.

For more advanced adjustment

Advanced gain search*

Easy servo adjustment for maximum machine performance without technical know-how.

- Easy: Operate just by following the flow.
- Reliable: No vibration in a machine during adjustment.
- Stable: Takes variations of mechanical characteristics in consideration.
- Quick: Takes approximately 10 minutes per axis for adjustment.
- Visual: Visually shows adjustment result.

Machine resonance suppression filter is automatically adjusted in addition to position and speed control gains. Adjusted parameters can be written into the servo amplifier by one-click on the screen.

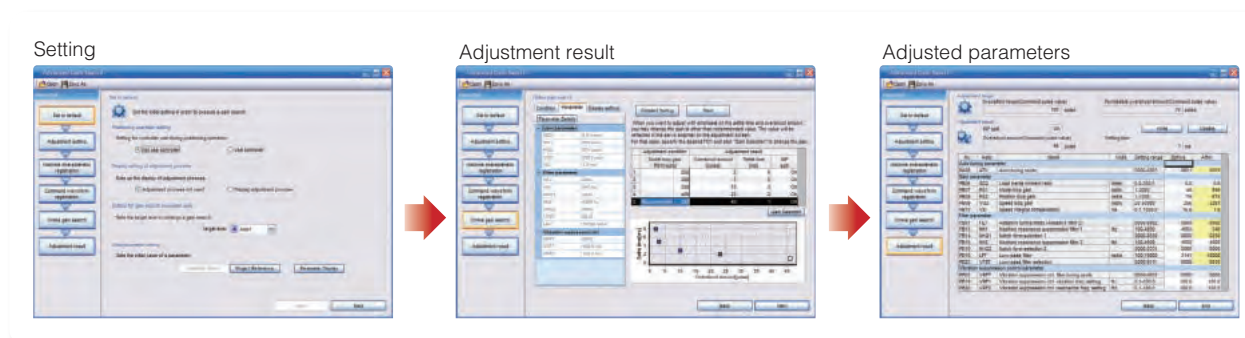

* This function is available with MR Configurator2 or MR Configurator.

Start-up and adjustment support tool

MR Configurator2 (SW1DNC-MRC2-E)

With the MR Configurator2, setup, tuning, monitor display, diagnostics, reading/writing parameters and test operations can be easily performed on a personal computer. This software realizes a stable machine system, optimum control and short setup time.

• [Servo assistant] function

Setup of the servo amplifier can be completed just by following guidance displays. Parameter setting and tuning are also easily performed since related functions can be called up from shortcut buttons.

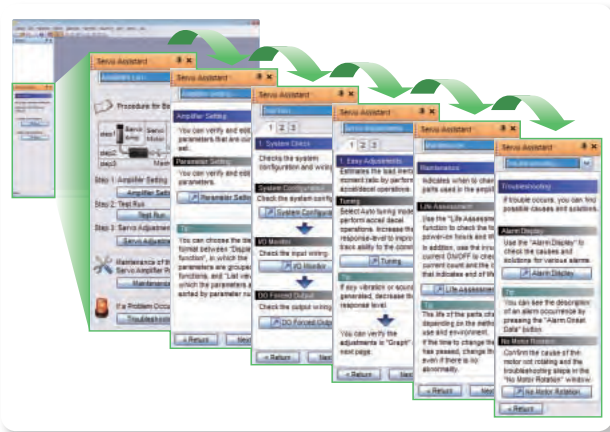

• [Monitor] function

Operation status can be monitored in real time on the "Display all" window. Assigning input/output signals and monitoring ON/OFF status are also possible on the "I/O monitor" window.

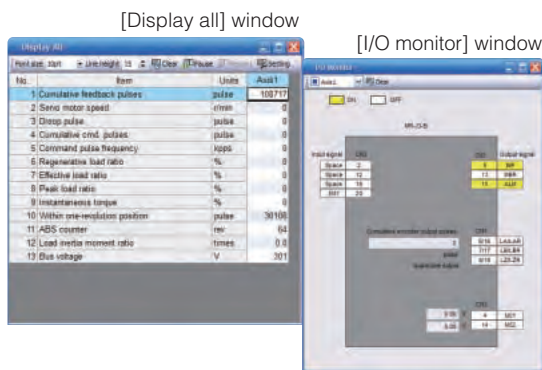

• [Machine analyzer] function

This function automatically inputs random torque to the servo motor and analyzes frequency characteristic (0.1kHz to 4.5kHz) of a machine system just by pressing the [Start] button. This function supports setting machine resonance suppression filter, etc.

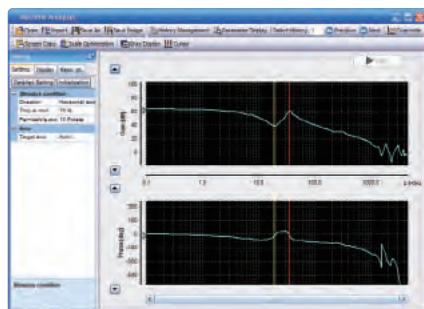

• Using MR Configurator2 via motion controller

For MR-J3-B servo amplifier, MR Configurator2 or MR Configurator can be used with MT Developer2 on a personal computer that is connected to a motion controller. (Note 1) Information such as parameter settings and monitoring for multiple servo amplifiers can be easily consolidated just by connecting the motion controller and the personal computer.

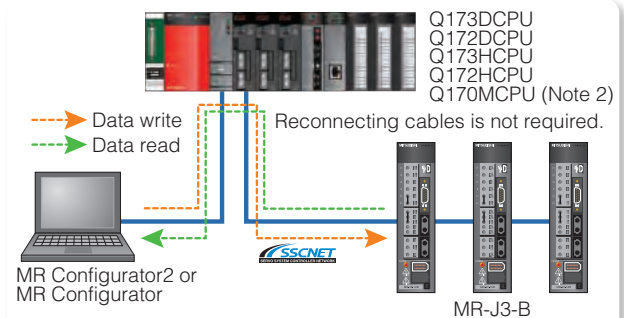

Notes: 1. MR Configurator software version C1 or above is compatible with MT Developer2. MT Developer2 software version 1.15F or above is compatible with MR Configurator2.
2. MR Configurator software version C2 or above is compatible with Q170MCPUCPU stand alone motion controller.

• [Parameter setting] function

Parameter setting is displayed in list or visual formats. Parameters can be set by selecting from the drop down list. In addition, in-position range can be set in mechanical system unit (e.g. μm).

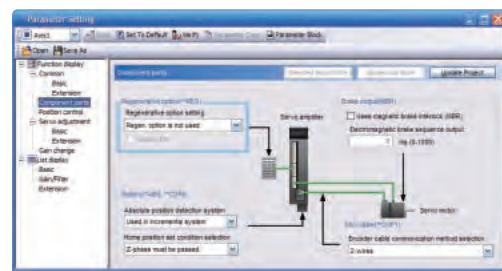

• [Graph] function

Servo data with 3 analog and 4 digital channels is displayed in a graph. Convenient functions such as [Over write] for overwriting multiple data and [Graph history] for displaying graph history are available. Waveform measurement for the connected axes are simultaneously performed via motion controller communication.

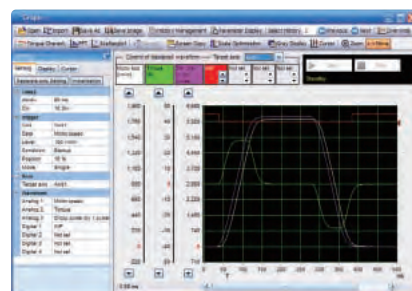

Servo Amplifiers for Satisfying Various Control

For satisfying machine needs, a wide variety of servo amplifiers are available in addition

Drive safety compatible servo amplifier: MR-J3-BSafety New!

For improving machine safety!

Realizing safety circuit

As a safety function, MR-J3-BSafety servo amplifier has an integrated Safe torque off (STO) function. With STO, the safety circuit, designed without a magnetic contactor (MC), prevents on unexpected start of servo motor. Stop category 1 (SS1 function) can be realized by combining MR-J3-BSafety with an optional MR-J3-D05 safety logic unit. The safety level of the STO and SS1 functions comply with IEC/EN 61508 SIL 2, EN62061 SIL CL2 and EN ISO 13849-1 PL d (Category 3).



Replacement of MR-J3-B

MR-J3-B can be easily replaced by the MR-J3-BSafety since both of these servo amplifiers use the same cables and connectors.

Compatible with fully closed loop control system

The MR-J3-BSafety lineup incorporates fully closed loop control system. MR-J3-B-RJ006 can be replaced by the MR-J3-BSafety.

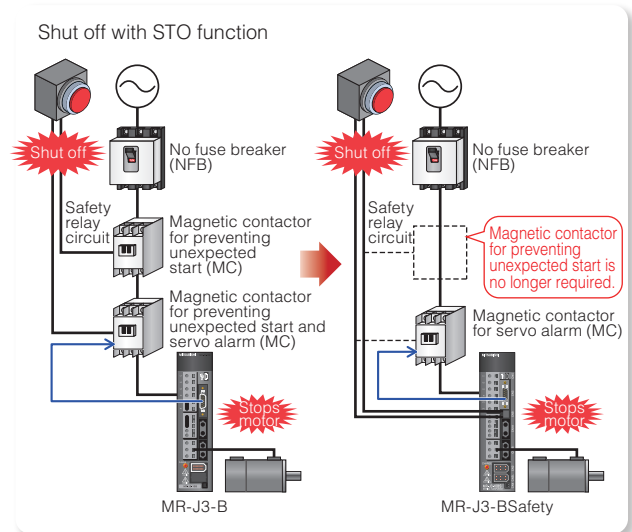

CC-Link compatible servo amplifier with built-in positioning function: MR-J3-T

Lower cost by reduced wiring with CC-Link network!

Built-in positioning function

By setting position and speed data in the point tables in the servo amplifier, positioning operation is possible with a start signal from a host controller.

Point table No.	Position data	Servo motor speed	Acceleration time constant	Deceleration time constant	Dwell time	Auxiliary function	M code
1	1000	2000	200	200	0	1	1
2	2000	1600	100	100	0	0	2
⋮	⋮	⋮	⋮	⋮	⋮	⋮	⋮
255	3000	3000	100	100	0	2	99

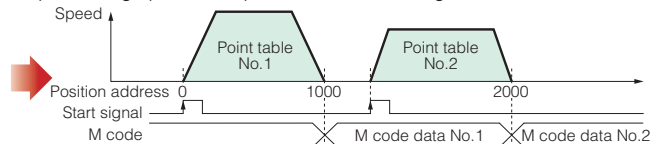

CC-Link communication compatible

Setting position and speed data in the point table, and start and stop operation are all possible via CC-Link communication. Servo monitor information is also transmitted to a host controller via CC-Link communication and can be used for control. CC-Link communication also makes it possible to design a system with the servo amplifiers dispersed throughout.

DI/O command with MR-J3-D01 extension IO unit (optional)

Selecting the point tables and starting positioning operation are possible by the DI command. In addition, alarm and M codes can be digitally output. (CC-Link communication is not available when using MR-J3-D01.)

Speed control operation New!

Speed command can be set directly with CC-Link remote register (when 2 stations are occupied).

Operational functions

- Roll feed function
- Indexer positioning operation
Capable of positioning to a set number of equally divided stations (up to 255 stations).

Parameter unit, MR-PRU03

Parameter setting, monitoring, alarm display and test operation are possible by connecting the MR-PRU03 to the servo amplifier. Up to 32 servo amplifier axes can be connected and controlled with a multi-drop system.



Command via CC-Link communication

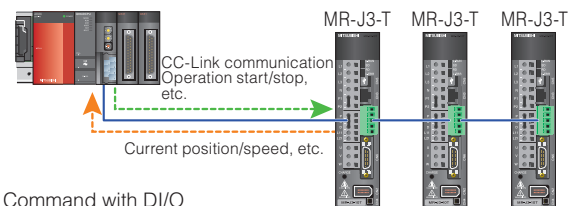

Command with DI/O

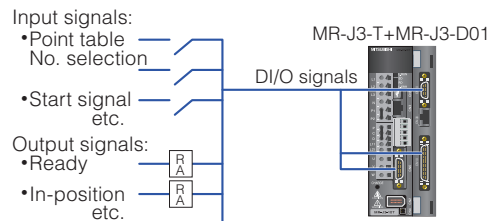

Indexer positioning operation

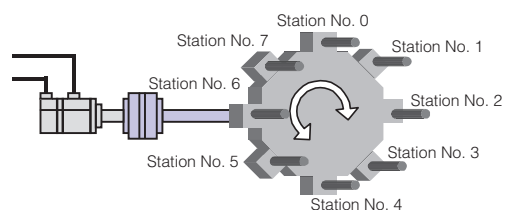

Requirements of Machines

to MR-J3-A with pulse train interface and MR-J3-B with SSCNET III compatible.

Fully closed loop control compatible servo amplifier: MR-J3-B-RJ006

For highly accurate load-side positioning!

High accuracy and high response position control

High response fully closed control function is realized with our original dual feedback control method*.

* The dual feedback control is performed by switching between servo motor encoder and load-side encoder.

Flexible system structure

MR-J3-B-RJ006 is compatible with a wide variety of other manufacturers' linear encoders, allowing users to create system that meets their precision requirements. Absolute position detection system is easily configured without a battery by using a serial interface ABS type linear encoder.

Linear encoder with compatible A/B/Z-phase pulse train interface can also be used.

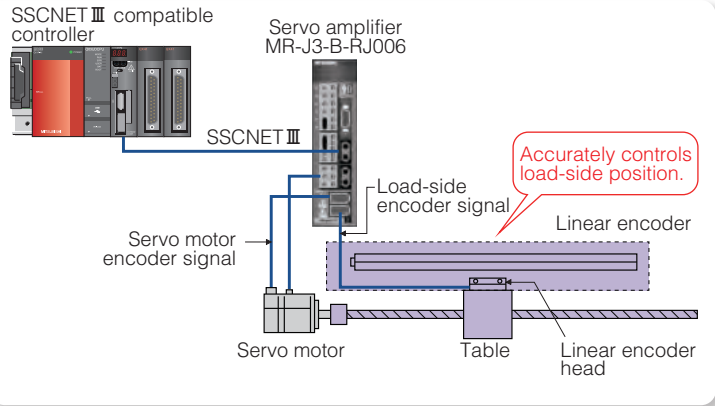

2-axis servo amplifier: MR-J3W-B New!

Eco-friendly and energy-conservative servo amplifier for a more compact machine at a smaller cost!

SSCNET III compatible 2-axis servo amplifier

MR-J3W-B servo amplifier has MR-J3-B servo amplifier's high performance, functionality and usability. One unit of MR-J3W-B operates any combination of two rotary/linear servo motors or direct drive motors.

Space-saving and reduced wiring

With the MR-J3W-B servo amplifier, two units of motors are operated by one unit of servo amplifier. Thus, mounting area of the servo amplifier can be smaller than ever.

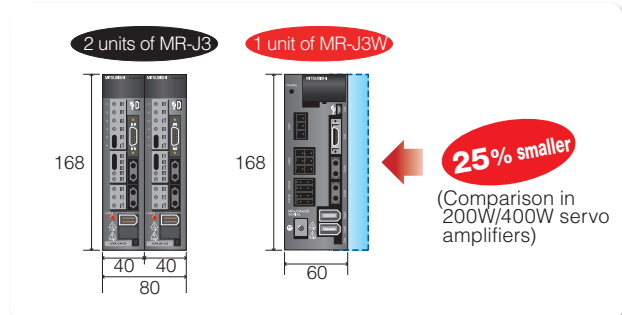
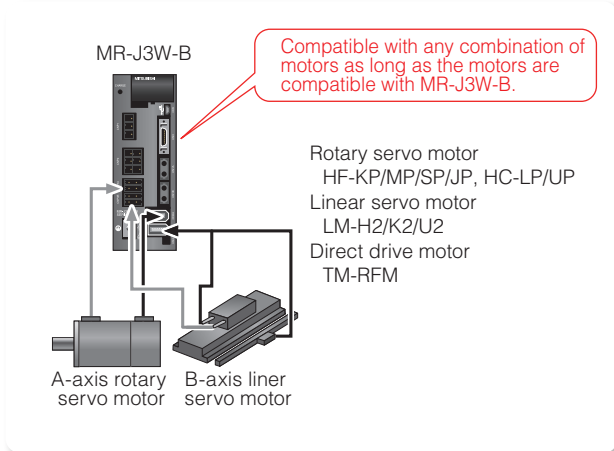

Contributes to energy saving

Two motors are operated by a common power supply. Thus, the regenerative energy can be effectively used.

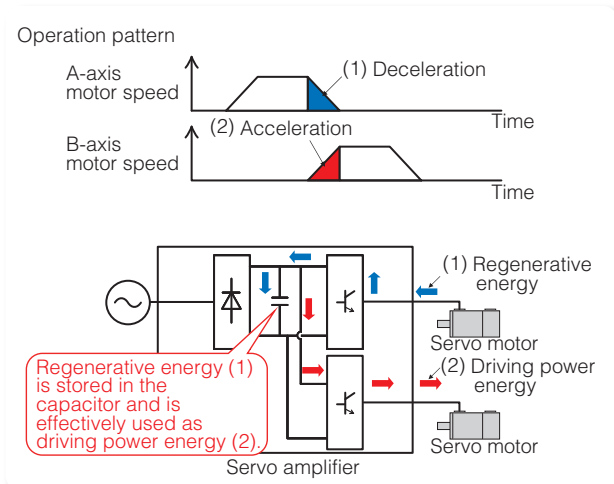

In addition, by configuring together with Q170MPCPU stand alone motion controller, overall system including a controller can be made further compact.

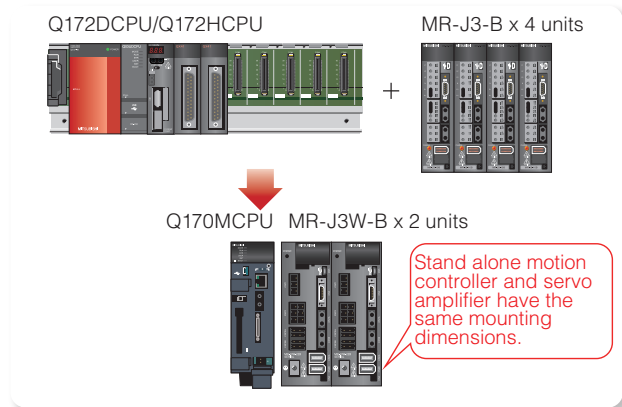

The two axes use the same main and control power supply, and SSCNET III cables. Thus, wiring is greatly reduced.

Common parameters with MR-J3-B

MR-J3W-B servo amplifier uses many of MR-J3-B(-RJ004)'s parameters. Replacement of MR-J3-B is easy. (Different parameters are partially used.)

A variety of Motor Lines for Optimal Machine

To satisfy machine drive needs, a wide variety of motors including rotary, linear

Rotary servo motor

Wide range of capacities and series for various applications.

Wide range of products

Motor capacities varying from 50W to 55kW with ultra-low to medium inertia are available for various applications. Low-inertia and high-speed HF-JP servo motor series is now also available in medium to large capacities.

Improved environmental safety

HF-KP/HF-MP/HC-LP/HC-RP/HC-UP servo motors are rated IP65 (excluding the shaft-through portion). HF-SP/HF-JP servo motors are rated IP67 (excluding the shaft-through portion).



HF-JP series (medium to large capacity) **New!**

- Low inertia, medium capacity servo motor (0.5kW to 9kW)
Max. speed: 6000r/min (rated speed: 3000r/min)*
This motor is suitable for frequent positioning and acceleration/deceleration operations, and optimal for food packaging and printing machines.
- Low inertia, large capacity fan-less servo motor (11kW, 15kW)
Max. speed: 3000r/min (rated speed: 1500r/min)
Compact size is realized by removing a cooling fan, and wiring is reduced by adopting a power supply connector (reduction by approximately 46% in volume and 34% in mass as compared to HA-LP series).
This motor is suitable for frequent positioning and acceleration/deceleration operations, and optimal for injection molding and large press machines.



* Max. speed of HF-JP703(4)/903(4): 5000r/min

Capacity range of servo motors

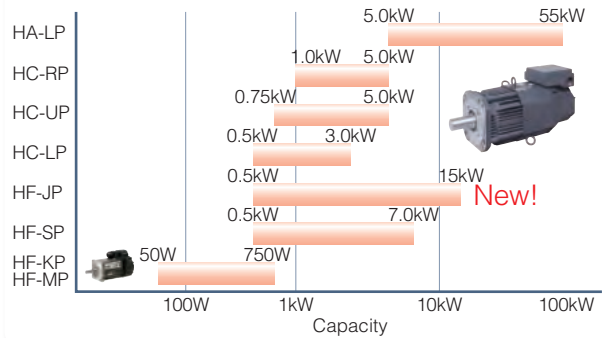

Application examples of HF-JP servo motor series

Roll feeder

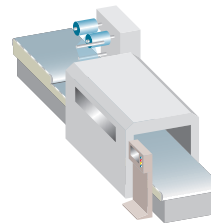

Press machine

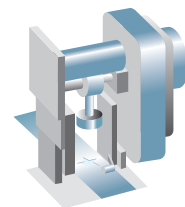

Linear servo motor

Suitable for direct drive system requiring high speed and accuracy!

High-speed and high-accuracy

High-speed operation (2m/s) is now possible with this direct drive system. (Conventional transmission mechanisms typically could not achieve such fast operational speeds.) A fully closed loop control system is realized by using position feedback signals from a load-side encoder such as a linear encoder.

Structuring flexible machine drive part

Direct drive arrangement with the linear servo motor enables compact driving part. The linear servo motor is suitable for long-stroke applications since the motor coil moves along with the motor magnet. By configuring multi-head systems with two motor coils on one motor magnet, non-complex and high-tact machine structures can be realized. In addition, the linear servo motors can be configured in tandem especially in large systems that require highly accurate synchronous operation between two axes.

Wide range of products

Continuous thrust: 50N to 6000N Max. thrust: 18000N

LM-H2/LM-F series

- The thrust to volume ratio is increased, allowing space-savings.
- High-rigidity is achieved due to the magnetic attraction force functions as a pre-load on the linear guide.

LM-K2/LM-U2 series

- Speed fluctuations are very small due to elimination of magnetic attraction force and cogging.
- The structure with no magnetic attraction force extends life of the linear guides and contributes to lowering audible noise.

For LM-F series, the continuous thrust is doubled by cooling forcibly with liquid.

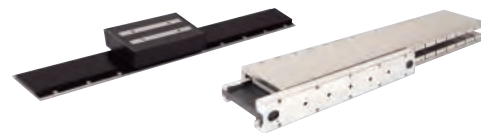

Tandem configuration

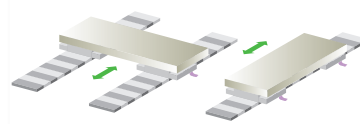

Multi-head configuration

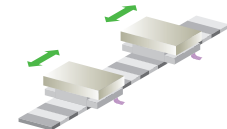

Thrust range of linear servo motors

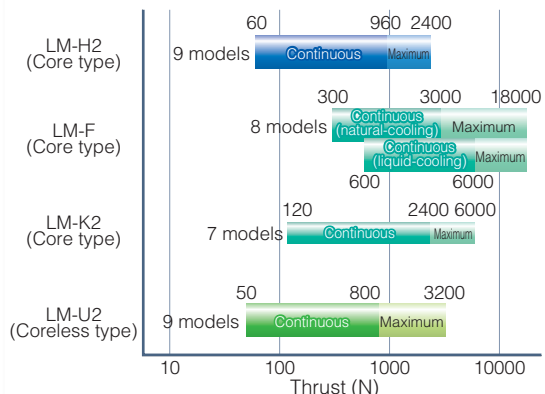

Drive

servo motors and direct drive motors are available.

Direct drive motor

For compact and simplified machine driving part with high-accuracy control!

Direct drive structure

Since load is coupled directly with the direct drive motor, gear reducer and transmission elements can be eliminated, offering greater rigidity and torque. Due to the gearless structure of the system, errors caused by backlash can be eliminated, thereby offering high-accuracy operation and shorter settling times. In addition, smooth rotation with less audible noise is possible.

The high-resolution encoder contributes to high-accuracy control. Lubrication and maintenance due to abrasion are not required.



Product lines

12 models are available.

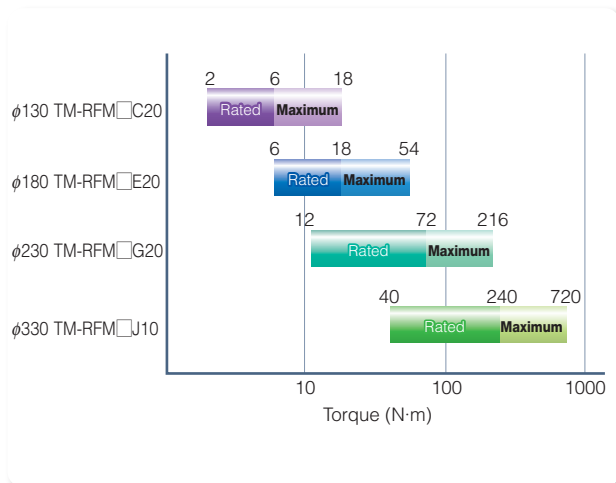

Simplifying machine structure

The motor's low profile design contributes to compact construction and a low center of gravity for enhanced machine stability.

The motor has an inner rotor with hollow shaft that allows cables and pipes to pass through.

This motor is suitable for rotation and index tables used in semiconductor manufacturing, liquid crystal manufacturing and machine tool devices.

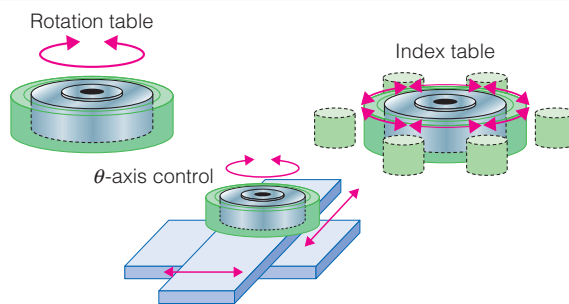

Motor capacity selection software

Freeware for easy calculation of motor capacity!

Capacity selection software (MRZJW3-MOTSZ111E)

Optimal servo amplifier, servo motor and optional regeneration unit can be selected just by entering constants and operation pattern.

Selection menu for linear servo motor is also available.

* This software will be compatible with direct drive motor soon.

Features

- (1) 10 types of machine components are available.
- (2) User-defined operation patterns can be set. (position and speed control mode operations)
- (3) Feedrate and torque can be displayed in graph format during the selection process.
- (4) Calculation process can be displayed.

* Capacity selection software (MRZJW3-MOTSZ111E) is available for free download. Contact your local sales office for more details.

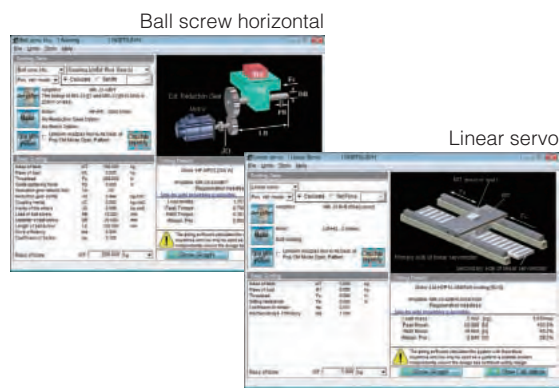

Conformity with global standards

Complies with EN, UL and CSA (c-UL) standards

MELSERVO-J3 conforms to global standards.

* This product is not subject to China Compulsory Certification (CCC).



* cULus mark is attached to MR-J3 series and cTUVus mark to MR-J3W series.

* Refer to "SERVO AMPLIFIER INSTRUCTION MANUAL" and "EMC Installation Guidelines" when your system needs to meet the EMC directive.

Complies with Restriction of Hazardous Substances Directive (RoHS).

Human and environment-friendly AC servo is compliant with RoHS Directive.

About RoHS directive

RoHS Directive requires member nations to guarantee that new electrical and electronic equipment sold in the market after July 1, 2006 do not contain lead, cadmium, mercury, hexavalent chromium, polybrominated biphenyl (PBB) and polybrominated diphenyl ether (PBDE) flame retardants. <G> mark indicating RoHS Directive compliance is printed on the package.







Our optional cables and connectors comply with "Measures for Administration of the Pollution Control of Electronic Information Products" (Chinese RoHS).

MELSERVO-J3 Product Lines

Flexible specifications corresponding to users' needs

■ Servo amplifiers

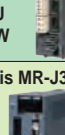
● : Compatible — : Not compatible

Servo amplifier type	Interface						Control mode					Model	Power supply spec.	Motor capacity, thrust or torque	Compatible motor series										
	Pulse train	Analog	DIO	SSCNET III	RS-422 multi-drop	CC-Link	Position	Speed	Torque	Positioning function	Fully closed loop control				HF-KP	HF-MP	HF-SP	HF-JP	HC-LP	HC-RP	HC-UP	HA-LP	LM-H2	LM-F	LM-K2
General-purpose interface 	● (*4)	● (*4)	—	—	●	—	●	●	●	—	—	MR-J3-□A(N) MR-J3-DU□A	3-phase 200VAC	0.05kW to 37kW	●	●	●	●	●	●	—	—	—	—	—
	—	—	—	—	—	—	—	—	—	—	—	MR-J3-□A1	1-phase 100VAC	0.05kW to 0.4kW	●	●	—	—	—	—	—	—	—	—	
	—	—	—	—	—	—	—	—	—	—	—	MR-J3-□A4 MR-J3-DU□A4	3-phase 400VAC	0.5kW to 55kW	—	—	●	●	—	—	—	—	—	—	
SSCNET III, new high-speed serial bus compatible      	—	—	—	●	—	—	●	—	—	—	—	MR-J3-□B(N) MR-J3-DU□B	3-phase 200VAC	0.05kW to 37kW	●	●	●	●	●	●	—	—	—	—	
	—	—	—	—	—	—	—	—	—	—	—	MR-J3-□B1	1-phase 100VAC	0.05kW to 0.4kW	●	●	—	—	—	—	—	—	—	—	
	—	—	—	—	—	—	—	—	—	—	—	MR-J3-□B4 MR-J3-DU□B4	3-phase 400VAC	0.5kW to 55kW	—	—	●	●	—	—	—	—	—	—	
	—	—	—	—	—	—	—	—	—	—	—	MR-J3-□S MR-J3-DU□S	3-phase 200VAC	0.05kW to 37kW	●	●	●	●	●	●	—	—	—	—	
	—	—	—	—	—	—	—	—	—	—	—	MR-J3-□S1	1-phase 100VAC	0.05kW to 0.4kW	●	●	—	—	—	—	—	—	—	—	
	—	—	—	—	—	—	—	—	—	—	—	MR-J3-□S4 MR-J3-DU□S4	3-phase 400VAC	0.5kW to 55kW	—	—	●	●	—	—	—	—	—	—	
	—	—	—	—	—	—	—	—	—	—	—	MR-J3-□B(N) -RJ006	3-phase 200VAC	0.05kW to 25kW	●	●	●	●	●	●	—	—	—	—	
	—	—	—	—	—	—	—	—	—	—	—	MR-J3-□B1 -RJ006	1-phase 100VAC	0.05kW to 0.4kW	●	●	—	—	—	—	—	—	—	—	
	—	—	—	—	—	—	—	—	—	—	—	MR-J3-□B4 -RJ006	3-phase 400VAC	0.5kW to 22kW	—	—	●	●	—	—	—	—	—	—	
	—	—	—	—	—	—	—	—	—	—	—	MR-J3-□B(4) -RJ004	3-phase 200VAC / 400VAC (*3)	60N to 960N (Natural-cooling) 300N to 3000N (Liquid-cooling) 600N to 6000N	—	—	—	—	—	—	—	●	—	—	—
—	—	—	—	—	—	—	—	—	—	—	MR-J3-□B(4) -RJ004	400VAC (*3)	120N to 2400N	—	—	—	—	—	—	—	—	—	●	—	
—	—	—	—	—	—	—	—	—	—	—	MR-J3-□B(4) -RJ004	400VAC (*3)	50N to 800N	—	—	—	—	—	—	—	—	—	—	●	
—	—	—	—	—	—	—	—	—	—	—	MR-J3-□B -RJ080W	3-phase 200VAC	2N·m to 240N·m	—	—	—	—	—	—	—	—	—	—	●	
—	—	—	—	—	—	—	—	—	—	—	MR-J3W-□B	3-phase 200VAC	0.05kW to 1kW 50N to 240N 2N·m to 40N·m x 2 units	●	●	●	●	●	—	●	—	●	●	●	
CC-Link compatible (with built-in positioning function) 	● (*1)	—	● (*2)	—	●	●	●	●	—	●	—	MR-J3-□T(N)	3-phase 200VAC	0.05kW to 25kW	●	●	●	●	●	●	—	—	—	—	
	—	—	—	—	—	—	—	—	—	—	—	MR-J3-□T1	1-phase 100VAC	0.05kW to 0.4kW	●	●	—	—	—	—	—	—	—	—	
	—	—	—	—	—	—	—	—	—	—	—	MR-J3-□T4	3-phase 400VAC	0.5kW to 22kW	—	—	●	●	—	—	—	—	—	—	

*1. Manual pulse generator (MR-HDP01) is required.

*2. Extension IO unit (MR-J3-D01) is required.









*3. For the linear servo compatible servo amplifiers, 3-phase 400VAC is available only in 22kW.

*4. High resolution analog speed and analog torque commands are available with a set of MR-J3-□A□-RJ040 and MR-J3-D01 extension IO unit. (Note that MR-J3-□A□-RJ040 is available only for 100V, 200V 22kW or smaller and 400V 11kW to 22kW).

*5. Contact your local sales office for the fully closed loop control compatible servo amplifier for 11kW and 15kW of HF-JP servo motor series.

Servo motors

● : Compatible

Servo motor series (*3)		Rated speed (maximum speed) (r/min)	Rated output (kW) (*1, 2)	Servo motor type	IP rating (*4)	Features	Application examples
				With electro-magnetic brake (B)			
Small capacity series	HF-KP series 	3000 (6000)	5 types 0.05, 0.1, 0.2, 0.4, 0.75	●	IP65	Low inertia Perfect for general industrial machines.	<ul style="list-style-type: none"> • Belt drives • Robots • Mounters • Sewing machines • X-Y tables • Food processing machines • Semiconductor manufacturing devices • Knitting and embroidery machines
	HF-MP series 	3000 (6000)	5 types 0.05, 0.1, 0.2, 0.4, 0.75	●	IP65	Ultra-low inertia Well suited for high-throughput operations.	<ul style="list-style-type: none"> • Inserters • Mounters
Medium capacity series	HF-SP series 	1000 (1500)	6 types 0.5, 0.85, 1.2, 2.0, 3.0, 4.2	●	IP67	Medium inertia Two types of the rated speed are available.	<ul style="list-style-type: none"> • Material handling systems • Robots • X-Y tables
		2000 (3000)	14 types 0.5, 1.0, 1.5, 2.0, 3.5, 5.0, 7.0 0.5, 1.0, 1.5, 2.0, 3.5, 5.0, 7.0	●	IP67		
	HC-LP series 	2000 (3000)	5 types 0.5, 1.0, 1.5, 2.0, 3.0	●	IP65	Low inertia Perfect for general industrial machines.	<ul style="list-style-type: none"> • Roll feeders • Loaders and unloaders • High-throughput material handling systems
	HC-RP series 	3000 (4500)	5 types 1.0, 1.5, 2.0, 3.5, 5.0	●	IP65	Ultra-low inertia Well suited for high-throughput operations.	<ul style="list-style-type: none"> • Ultra-high-throughput material handling systems
Flat Medium capacity series	HC-UP series 	2000 (3000:0.75kW to 2kW) (2500:3.5kW, 5kW)	5 types 0.75, 1.5, 2.0, 3.5, 5.0	●	IP65	Flat type The flat design makes this unit well suited for situations where the installation space is limited.	<ul style="list-style-type: none"> • Robots • Food processing machines
Medium/Large capacity series	HF-JP series 	3000 (6000:0.5kW to 5kW) (5000:7kW, 9kW)	18 types 0.5, 0.75, 1.0, 1.5, 2.0, 3.5, 5.0, 7.0, 9.0 0.5, 0.75, 1.0, 1.5, 2.0, 3.5, 5.0, 7.0, 9.0	●	IP67	Low inertia Well suited for high-throughput and high-acceleration/deceleration operations.	<ul style="list-style-type: none"> • Food processing machines • Printing machines
		1500 (3000)	4 types 11, 15 11, 15	●	IP67		<ul style="list-style-type: none"> • Injection molding machines • Large press machines
	HA-LP series 	1000 (1200)	16 types 6.0, 8.0, 12, 15, 20, 25, 30, 37 6.0, 8.0, 12, 15, 20, 25, 30, 37	● (Only for 6.0kW to 12kW)	IP44	Low inertia Three types of the rated speed are available. As standard, 30kW and larger motors can be mounted either with the flange or the feet. (*5)	<ul style="list-style-type: none"> • Injection molding machines • Semiconductor manufacturing devices • Large material handling systems • Press machines
1500 (2000)	14 types 7.0, 11, 15, 22, 30, 37 7.0, 11, 15, 22, 30, 37, 45, 50	● (Only for 7.0kW to 15kW)	IP44				
2000 (2000)	14 types 5.0, 7.0, 11, 15, 22, 30, 37 11, 15, 22, 30, 37, 45, 55	● (Only for 11kW to 22kW)	IP44 IP65 for HA-LP502/702				

*1. [] are for 400V class.





*2. Contact your local sales office for servo motors larger than 55kW.

*3. Actual product availability may vary according to region.

*4. The shaft-through portion is excluded.

*5. Some motors from 15kW to 25kW capacities can be mounted with the feet. Refer to the section "Servo Motor Dimensions" in this catalog.

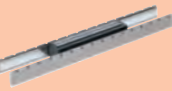
Linear servo motors

Linear servo motor series	Maximum speed (m/s)	Continuous thrust (N) (*1)	Cooling method	Features	Application examples
LM-H2 series 	2.0	60, 120, 240, 360, 480, 720, 960	Natural-cooling	Core type suitable for space-saving. The magnetic attraction force contributes to high rigidity.	<ul style="list-style-type: none"> • Semiconductor mounting systems • Wafer cleaning systems • LCD assembly systems
LM-F series 	2.0	300, 600, 900, 1200, 1800, 2400, 3000	Natural-cooling	Core type compact linear servo motor. The integrated liquid-cooling system doubles the continuous thrust.	<ul style="list-style-type: none"> • NC machine tools • Material handlings
	2.0	600, 1200, 1800, 2400, 3600, 4800, 6000	Liquid-cooling		
LM-K2 series 	2.0	120, 240, 360, 720, 1200, 1440, 2400	Natural-cooling	Core type with magnetic attraction counter-force. The magnetic attraction counter-force structure extends life of the linear guides and contributes to lowering audible noise.	<ul style="list-style-type: none"> • Semiconductor mounting systems • Wafer cleaning systems • LCD assembly systems (multi-head use)
LM-U2 series 	2.0	50, 75, 100, 150, 225, 400, 600, 800	Natural-cooling	Coreless type without cogging resulting in small speed fluctuation. The structure with no magnetic attraction force extends life of the linear guides.	<ul style="list-style-type: none"> • Screen printing systems • Scanning exposure systems • Inspection systems

Direct drive motors

Direct drive motor series	Motor outer diameter	Rated speed (Maximum speed) (r/min)	Rated torque (N·m)	IP rating (*2)	Features	Application examples
TM-RFM series 	φ130	200 (500)	2, 4, 6	IP42	The motor's low profile design contributes to compact construction and a low center of gravity for enhanced machine stability.	<ul style="list-style-type: none"> • Semiconductor manufacturing devices • Liquid crystal manufacturing devices • Machine tool devices
	φ180	200 (500)	6, 12, 18	IP42		
	φ230	200 (500)	12, 48, 72	IP42		
	φ330	100 (200)	40, 120, 240	IP42		

*1. are for 400V class.

*2. Connectors and gap between rotor and stator are excluded.

■ Servo amplifier outlines

MR-J3-A | General-purpose interface

Pulse train and analog input are available as a general-purpose interface. Position, speed or torque control mode can be selected. Machine's performance can be boosted by using the optimum adjustment function such as advanced vibration suppression control and adaptive filter **II**.

MR-J3-B | SSCNET **III** compatible

By adopting SSCNET **III** (optical communication), a complete synchronous system can be configured by using the high-speed serial communication with cycle time as fast as 0.44ms between the controller and servo amplifier. SSCNET **III** can be set up just by inserting a dedicated cable (fiber-optic cable) into connectors, resulting in reduced wiring and preventing possibility of wiring error.

Thanks to the optical communication, noise immunity has been greatly improved, and long distance wiring is made possible by up to 800m (maximum of 50m between stations x 16 axes).

Fully closed loop control compatible servo amplifier is also available (MR-J3-B-RJ006).

MR-J3-BSafety | Drive safety compatible

STO function has been added to the SSCNET **III** compatible servo amplifier as a safety function. By using the STO function, magnetic contactors previously required for preventing unexpected start are no longer required. SS1 function can be realized by using MR-J3-D05 safety logic unit. MR-J3-BSafety lineup incorporates fully closed loop control system.

MR-J3W-B | 2-axis servo amplifier

With the same high performance and same functions of MR-J3-B, one unit of MR-J3W-B servo amplifier operates two motors including combinations of rotary and linear servo motor, and direct drive motor.

Installation space has been reduced by approximately 17% to 25% as compared to two units of MR-J3 series servo amplifier, allowing your system to be more compact. In addition, as the two axes are able to share cables for power supplies and SSCNET **III** communication, wiring is reduced.

MR-J3-T | CC-Link compatible (with built-in positioning function)

By setting position and speed data in the point tables in the servo amplifier, positioning operation is possible with a start signal from a host controller. Setting position and speed data in the point table, and start and stop operation are possible via CC-Link communication. By using MR-J3-D01 extension IO unit, point table selection and positioning operation with DI/O commands are enabled. (CC-Link communication is not available when using the MR-J3-D01.)

MELSERVO-J3

For Servo Amplifier Model Designation

MR-J3-

Mitsubishi general-purpose
AC servo amplifier
MELSERVO-J3 Series

A(N) : General-purpose interface
B(N) : SSCNET III compatible
T(N) : CC-Link compatible (with built-in
positioning function)

Symbol	Rated output (kW)
10	0.1
20	0.2
40	0.4
60	0.6
70	0.75
100	1
200	2
350	3.5
500	5
700	7
11K	11
15K	15
22K	22

Symbol	Special specifications
U004	1-phase 200 to 240VAC (Note 1)
RJ040	Compatible with high resolution analog speed command and analog torque command (Note 2)
RJ006	Compatible with fully closed loop control (Note 3)
RU006	Compatible with fully closed loop control, without a dynamic brake (Note 3, 6)
RZ006	Compatible with fully closed loop control, without an enclosed regenerative resistor (Note 3, 4)
RJ004	Linear servo motor compatible (Note 3)
RJ080W	Direct drive motor compatible (Note 3)
KE	Compatible with 4Mpps command (Note 5)
ED	Without a dynamic brake (Note 6)
PX	Without an enclosed regenerative resistor (Note 4)
LR	Dedicated servo amplifier for HF-JP servo motor of 11kW and 15kW, with an enclosed regenerative resistor
LW	Dedicated servo amplifier for HF-JP servo motor of 11kW and 15kW, without an enclosed regenerative resistor (Note 7)

- Notes: 1. Available in 750W or smaller servo amplifier.
2. Available in MR-J3-□A□ only. Extension IO unit, MR-J3-D01, is required.
3. Available in the fully closed loop control compatible, linear servo compatible and direct drive motor compatible servo amplifiers MR-J3-□B□R□ only.
4. Available in 11kW to 22kW servo amplifier. A regenerative resistor (standard accessory) is not enclosed.
5. Available in MR-J3-□A(1) only.
6. Dynamic brake does not work at alarm occurrence or power failure. Take measures to ensure safety on the entire system.
7. This servo amplifier is required when using HF-JP servo motor of 11kW and 15kW. Regenerative resistor is not included.

Symbol	Power supply
None	3-phase 200VAC or 1-phase 200VAC (Note 1)
1	1-phase 100VAC (Note 2)
4	3-phase 400VAC (Note 3)

- Notes: 1. MR-J3-10□, -20□, -40□, -60□ and -70□ are available for 1-phase 200VAC.
2. MR-J3-10□1, -20□1 and -40□1 are available.
3. MR-J3-60□4, -100□4, -200□4, -350□4, -500□4, -700□4, -11K□4, -15K□4 and 22K□4 are available.

List of compatible servo motors

Symbol	200V class								400V class			
	HF-KP	HF-MP	HF-SP	HF-JP	HC-LP	HC-RP	HC-UP	HA-LP	HF-SP	HF-JP	HA-LP	
10	053, 13	053, 13	—	—	—	—	—	—	—	—	—	
20	23	23	—	—	—	—	—	—	—	—	—	
40	43	43	—	—	—	—	—	—	—	—	—	
60	—	—	51, 52	53	—	52	—	—	524	534	—	
70	73	73	—	73	—	—	72	—	—	—	—	
100	—	—	81, 102	103	53 (Note 1)	102	—	—	1024	734, 1034	534 (Note 1)	
200	—	—	121, 201, 152, 202	153, 203	73, 103 (Note 1)	152	103, 153	152	1524, 2024	1534, 2034	734, 1034 (Note 1)	
350	—	—	301, 352	353	153, 203 (Note 1)	202	203	202	3524	3534	1534, 2034 (Note 1)	
500	—	—	421, 502	503	353 (Note 1)	302	353, 503	352, 502	5024	5034	3534 (Note 1)	
700	—	—	702	703	503 (Note 1)	—	—	—	601, 701M, 702	7024	7034	5034 (Note 1)
11K	—	—	—	903, 11K1M (Note 2)	—	—	—	—	801, 12K1, 11K1M, 11K2	9034, 11K1M4 (Note 2)	—	8014, 12K14, 11K1M4, 11K24
15K	—	—	—	15K1M (Note 2)	—	—	—	—	15K1, 15K1M, 15K2	15K1M4 (Note 2)	—	15K14, 15K1M4, 15K24
22K	—	—	—	—	—	—	—	—	20K1, 25K1, 22K1M, 22K2	—	—	20K14, 22K1M4, 22K24

- Notes: 1. Use this servo motor when increasing the maximum torque.
2. Use a dedicated servo amplifier MR-J3-□A(4)/B(4)/T(4)-LR-/LW for HF-JP11K1M(4) and HF-JP15K1M(4). These servo motors cannot be used with any other servo amplifiers without "LR-/LW".

*The servo amplifiers above conform to EN, UL and c-UL standards.

For Drive Unit/Converter Unit Model Designation

■For drive unit 200VAC/400VAC

MR-J3-DU 30K A

Mitsubishi general-purpose
AC servo amplifier
MELSERVO-J3 Series

A: General-purpose interface
B: SSCNET III compatible

Symbol	Power supply
None	3-phase 200VAC
4	3-phase 400VAC

Symbol	Rated output (kW)	Compatible servo motor
		HA-LP
30K	30	30K1, 30K1M, 30K2, 25K14, 30K14, 30K1M4, 30K24
37K	37	37K1, 37K1M, 37K2, 37K14, 37K1M4, 37K24
45K	45	45K1M4, 45K24
55K	55	50K1M4, 55K24

Converter unit
(MR-J3-CR55K(4))
is required for the
drive unit.

■For converter unit 200VAC/400VAC

MR-J3-CR 55K

Mitsubishi general-purpose
AC servo amplifier
MELSERVO-J3 Series

Rated output: 55kW

Symbol	Power supply
None	3-phase 200VAC
4	3-phase 400VAC

*The drive unit and the converter unit conform to EN, UL and c-UL standards.

MELSERVO-J3

For Servo Motor Model Designation

■100V/200V class

HF-KP **05** **3** **B**

Symbol	Servo motor series
HF-KP	Low inertia, small capacity
HF-MP	Ultra-low inertia, small capacity
HF-SP	Medium inertia, medium capacity
HF-JP	Low inertia, medium-large capacity
HC-LP	Low inertia, medium capacity
HC-RP	Ultra-low inertia, medium capacity
HC-UP	Flat type, medium capacity
HA-LP	Low inertia, medium-large capacity

Symbol	Rated output (kW)
05	0.05
1 to 8	0.1 to 0.85
10 to 90	1.0 to 9.0
11K to 37K	11 to 37

Symbol	Rated speed (r/min)
1	1000
1M	1500
2	2000
3	3000

Symbol	Electromagnetic brake
None	None
B	Installed

Note: Refer to the section "Electromagnetic brake specifications" in this catalog for the available models and detailed specifications.

Symbol	Oil seal
None	None (Note1)
J	Installed (Note2, 3)

Notes: 1. An oil seal is attached for HF-JP/HC-LP/HC-RP/HC-UP/HA-LP series as standard.
2. Oil seal is available for 0.1kW or larger HF-KP/HF-MP series and all HF-SP series.
3. Dimensions for HF-KP/HF-MP/HF-SP series with an oil seal is different from the standard models. Contact your local sales office for details.

Symbol	Shaft end
None	Standard (Straight shaft)
K	Key way or with key (Note1)
D	D-cut (Note1)

Notes: 1. Refer to the section "Special shaft end specifications" in this catalog for the available models and detailed specifications.

■400V class

HF-SP **5** **2** **4** **B**

Symbol	Servo motor series
HF-SP	Medium inertia, medium capacity
HF-JP	Low inertia, medium-large capacity
HA-LP	Low inertia, medium-large capacity

400VAC class

Symbol	Rated output (kW)
5	0.5
10 to 90	1.0 to 9.0
11K to 55K	11 to 55

Symbol	Rated speed (r/min)
1	1000
1M	1500
2	2000
3	3000

Symbol	Electromagnetic brake
None	None
B	Installed

Note: Refer to the section "Electromagnetic brake specifications" in this catalog for the available models and detailed specifications.

Symbol	Oil seal
None	None (Note1)
J	Installed (Note2)

Notes: 1. An oil seal is attached for HF-JP/HA-LP series as standard.
2. Dimensions for HF-SP series with an oil seal is different from the standard models. Contact your local sales office for details.

Symbol	Shaft end
None	Standard (Straight shaft)
K	Key way (Note1)

Notes: 1. Refer to the section "Special shaft end specifications" in this catalog for the available models and detailed specifications.

* The servo motors above conform to EN standard. Contact your local sales office for the models conform to UL and c-UL standards.



HF-KP Series Servo Motor Specifications

Servo motor series		HF-KP series (Low inertia, small capacity)				
Servo motor model HF-KP		053(B)	13(B)	23(B)	43(B)	73(B)
Compatible servo amplifier model MR-J3-		10A(1)/B(1)(-RJ006)/T(1)		20A(1)/B(1)(-RJ006)/T(1)	40A(1)/B(1)(-RJ006)/T(1)	70A/B(-RJ006)/T
Power supply capacity (Note 1) (kVA)		0.3	0.3	0.5	0.9	1.3
Continuous running duty	Rated output (W)	50	100	200	400	750
	Rated torque (Note 9) (N·m [oz·in])	0.16 (22.7)	0.32 (45.3)	0.64 (90.6)	1.3 (184)	2.4 (340)
Maximum torque (when increased) (Note 8) (N·m [oz·in])		0.56 (79.3)	1.11 (157)	2.23 (316)	4.46 (632)	8.36 (1180)
Maximum torque (N·m [oz·in])		0.48 (68.0)	0.95 (135)	1.9 (269)	3.8 (538)	7.2 (1020)
Rated speed (r/min)		3000				
Maximum speed (r/min)		6000				
Permissible instantaneous speed (r/min)		6900				
Power rate at continuous rated torque (kW/s)		4.87	11.5	16.9	38.6	39.9
Rated current (A)		0.9	0.8	1.4	2.7	5.2
Maximum current (when increased) (Note 8) (A)		3.1	2.8	4.9	9.5	18.2
Maximum current (A)		2.7	2.4	4.2	8.1	15.6
Regenerative braking frequency (times/min) (Note 2)		(Note 3)	(Note 3)	448	249	140
Moment of inertia J ($\times 10^{-4}$ kg·m ²) [J (oz·in ²)]	Standard	0.052 (0.284)	0.088 (0.481)	0.24 (1.31)	0.42 (2.30)	1.43 (7.82)
	With electromagnetic brake	0.054 (0.295)	0.090 (0.492)	0.31 (1.69)	0.50 (2.73)	1.63 (8.91)
Recommended load to motor inertia moment ratio (Note 4)		15 times maximum		24 times maximum	22 times maximum	15 times maximum
Speed/position detector		18-bit encoder (resolution: 262144 p/rev)				
Attachments		— (Motors with an oil seal are available (HF-KP□J))				
Insulation class		Class B				
Structure		Totally enclosed non ventilated (IP rating: IP65) (Note 5)				
Environment (Note 7)	Ambient temperature	0 to 40°C (32 to 104°F) (non freezing), storage: -15 to 70°C (5 to 158°F) (non freezing)				
	Ambient humidity	80% RH maximum (non condensing), storage: 90% RH maximum (non condensing)				
	Atmosphere	Indoors (no direct sunlight); no corrosive gas, inflammable gas, oil mist or dust				
	Elevation	1000m or less above sea level				
	Vibration (Note 6)	X: 49m/s ² Y: 49m/s ²				
Mass (kg [lb])	Standard	0.35 (0.78)	0.56 (1.3)	0.94 (2.1)	1.5 (3.3)	2.9 (6.4)
	With electromagnetic brake	0.65 (1.5)	0.86 (1.9)	1.6 (3.6)	2.1 (4.7)	3.9 (8.6)

Notes: 1. The power supply capacity varies depending on the power supply's impedance.

- The regenerative braking frequency shows the permissible frequency when the motor, without a load and an optional regeneration unit, decelerates from the rated speed to a stop. When a load is connected; however, the value will be the table value/(m+1), where m=load inertia moment/motor inertia moment. When the operating speed exceeds the rated speed, the regenerative braking frequency is inversely proportional to the square of (operating speed/rated speed). If the operating speed changes frequently or when the regeneration is constant (as with vertical feeds), find the regenerative heating value (W) in operation. Provisions must be made to keep this heating value below the tolerable regenerative power (W). Optimal regenerative resistor varies for each system. Select the most suitable regenerative resistor by using the capacity selection software. Refer to the section "Options ● Optional regeneration unit" in this catalog for details on the tolerable regenerative power (W).
- When the motor decelerates to a stop from the rated speed, the regenerative frequency will not be limited if the effective torque is within the rated torque range. When the motor decelerates to a stop from the maximum speed, the regenerative frequency will not be limited if the effective torque is within the rated torque range and if the load to motor inertia moment is 8 times or less for HF-KP053(B) or 4 times or less for HF-KP13(B).
- Contact your local sales office if the load to motor inertia moment ratio exceeds the value in the table.
- The shaft-through portion is excluded.
- The vibration direction is shown in the diagram to the right. The numeric value indicates the maximum value of the component (commonly the bracket in the opposite direction of the motor shaft). Fretting of the bearing occurs easily when the motor stops, so maintain vibration to approximately one-half of the allowable value.
- In the environment where the servo motor is exposed to oil mist, oil and/or water, a standard specification servo motor may not be usable. Contact your local sales office for more details.
- The maximum torque can be increased from 300% to 350% of the rated torque by setting servo amplifier's parameter. Refer to "Combinations for Increasing the Maximum Torque" in this catalog for more details.
- When unbalanced torque is generated, such as in a vertical lift machine, it is recommended that the unbalanced torque of the machine be kept under 70% of the motor's rated torque.

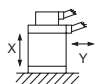

HF-KP Series Servo Motor Torque Characteristics

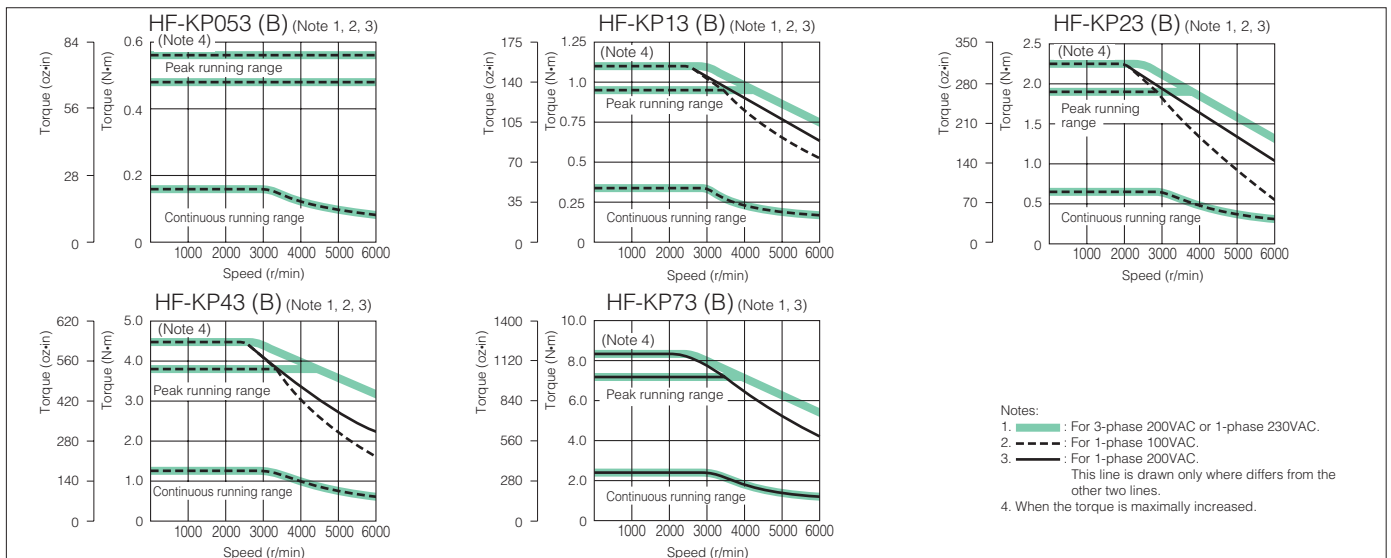

Model designation
Servo motors
Servo amplifiers
Options
Peripheral equipment
MR-J3-B Safety series
MR-J3W series
Servo support software
Cautions
Warranty
Global FA centers



HF-MP Series Servo Motor Specifications

Servo motor series		HF-MP series (Ultra-low inertia, small capacity)				
Servo motor model HF-MP		053(B)	13(B)	23(B)	43(B)	73(B)
Compatible servo amplifier model (Note 7) MR-J3-		10A(1)/B(1)(-RJ006)/T(1)		20A(1)/B(1)(-RJ006)/T(1)	40A(1)/B(1)(-RJ006)/T(1)	70A/B(-RJ006)/T
Power supply capacity (Note 1) (kVA)		0.3	0.3	0.5	0.9	1.3
Continuous running duty	Rated output (W)	50	100	200	400	750
	Rated torque (Note 9) (N·m [oz·in])	0.16 (22.7)	0.32 (45.3)	0.64 (90.6)	1.3 (184)	2.4 (340)
Maximum torque (N·m [oz·in])		0.48 (68.0)	0.95 (135)	1.9 (269)	3.8 (538)	7.2 (1020)
Rated speed (r/min)		3000				
Maximum speed (r/min)		6000				
Permissible instantaneous speed (r/min)		6900				
Power rate at continuous rated torque (kW/s)		13.3	31.7	46.1	111.6	95.5
Rated current (A)		1.1	0.9	1.6	2.7	5.6
Maximum current (A)		3.2	2.8	5.0	8.6	16.7
Regenerative braking frequency (times/min) (Note 2)		(Note 3)	(Note 3)	1570	920	420
Moment of inertia J ($\times 10^{-4}$ kg·m ²) [J (oz·in ²)]	Standard	0.019 (0.104)	0.032 (0.175)	0.088 (0.481)	0.15 (0.820)	0.60 (3.28)
	With electromagnetic brake	0.025 (0.137)	0.039 (0.213)	0.12 (0.656)	0.18 (0.984)	0.70 (3.83)
Recommended load to motor inertia moment ratio		Maximum of 30 times the servo motor's inertia moment (Note 4)				
Speed/position detector		18-bit encoder (resolution: 262144 p/rev)				
Attachments		—	— (Motors with an oil seal are available (HF-MP□J))			
Insulation class		Class B				
Structure		Totally enclosed non ventilated (IP rating: IP65) (Note 5)				
Environment (Note 8)	Ambient temperature	0 to 40°C (32 to 104°F) (non freezing), storage: -15 to 70°C (5 to 158°F) (non freezing)				
	Ambient humidity	80% RH maximum (non condensing), storage: 90% RH maximum (non condensing)				
	Atmosphere	Indoors (no direct sunlight); no corrosive gas, inflammable gas, oil mist or dust				
	Elevation	1000m or less above sea level				
	Vibration (Note 6)	X: 49m/s ² Y: 49m/s ²				
Mass (kg [lb])	Standard	0.35 (0.78)	0.56 (1.3)	0.94 (2.1)	1.5 (3.3)	2.9 (6.4)
	With electromagnetic brake	0.65 (1.5)	0.86 (1.9)	1.6 (3.6)	2.1 (4.7)	3.9 (8.6)

Notes: 1. The power supply capacity varies depending on the power supply's impedance.

2. The regenerative braking frequency shows the permissible frequency when the motor, without a load and an optional regeneration unit, decelerates from the rated speed to a stop. When a load is connected; however, the value will be the table value/(m+1), where m=load inertia moment/motor inertia moment. When the operating speed exceeds the rated speed, the regenerative braking frequency is inversely proportional to the square of (operating speed/rated speed). If the operating speed changes frequently or when the regeneration is constant (as with vertical feeds), find the regenerative heating value (W) in operation. Provisions must be made to keep this heating value below the tolerable regenerative power (W). Optimal regenerative resistor varies for each system. Select the most suitable regenerative resistor by using the capacity selection software. Refer to the section "Options ● Optional regeneration unit" in this catalog for details on the tolerable regenerative power (W).

3. When the motor decelerates to a stop from the rated speed, the regenerative frequency will not be limited if the effective torque is within the rated torque range. When the motor decelerates to a stop from the maximum speed, the regenerative frequency will not be limited if the effective torque is within the rated torque range and if the load to motor inertia moment is 26 times or less for HF-MP053(B) or 15 times or less for HF-MP13(B).

4. Contact your local sales office if the load to motor inertia moment ratio exceeds the value in the table.

5. The shaft-through portion is excluded.

6. The vibration direction is shown in the diagram to the right. The numeric value indicates the maximum value of the component (commonly the bracket in the opposite direction of the motor shaft). Fretting of the bearing occurs easily when the motor stops, so maintain vibration to approximately one-half of the allowable value.

7. To use MR-J3□A(1) with the HF-MP series, the servo amplifier's software version must be A4 or above.

8. In the environment where the servo motor is exposed to oil mist, oil and/or water, a standard specification servo motor may not be usable. Contact your local sales office for more details.

9. When unbalanced torque is generated, such as in a vertical lift machine, it is recommended that the unbalanced torque of the machine be kept under 70% of the motor's rated torque.



HF-MP Series Servo Motor Torque Characteristics

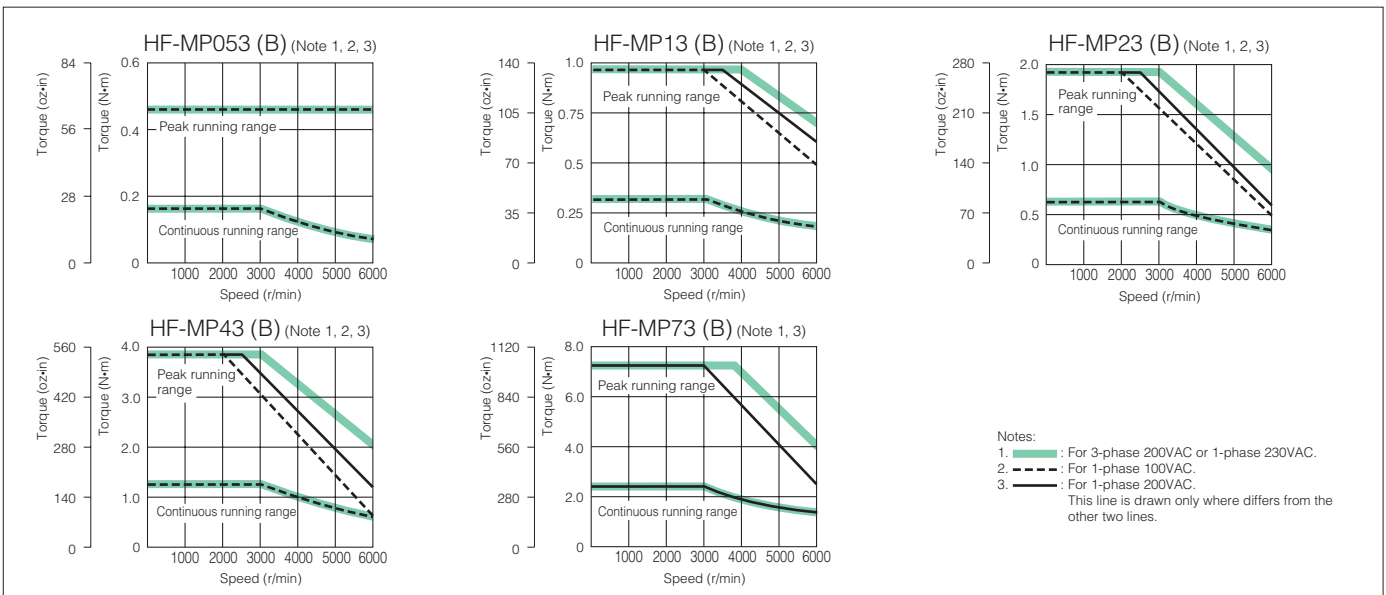

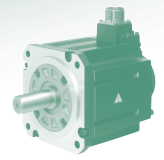

HF-SP 1000r/min Series Servo Motor Specifications

Servo motor series		HF-SP 1000r/min series (Medium inertia, medium capacity)					
Servo motor model HF-SP		51(B)	81(B)	121(B)	201(B)	301(B)	421(B)
Compatible servo amplifier model MR-J3-		60A/B(-RJ006)/T (Note 6)	100A/B(-RJ006)/T (Note 6)	200AN/BN(-RJ006)/TN (Note 6)		350A/B(-RJ006)/T	500A/B(-RJ006)/T
Power supply capacity (Note 1) (kVA)		1.0	1.5	2.1	3.5	4.8	6.3
Continuous running duty	Rated output (kW)	0.5	0.85	1.2	2.0	3.0	4.2
	Rated torque (Note 8) (N·m [oz·in])	4.77 (675)	8.12 (1150)	11.5 (1630)	19.1 (2700)	28.6 (4050)	40.1 (5680)
Maximum torque (N·m [oz·in])		14.3 (2020)	24.4 (3460)	34.4 (4870)	57.3 (8110)	85.9 (12200)	120 (17000)
Rated speed (r/min)		1000					
Maximum speed (r/min)		1500					
Permissible instantaneous speed (r/min)		1725					
Power rate at continuous rated torque (kW/s)		19.2	37.0	34.3	48.6	84.6	104
Rated current (A)		2.9	4.5	6.5	11	16	24
Maximum current (A)		8.7	13.5	19.5	33	48	72
Regenerative braking frequency (times/min) (Note 2)		36	90	188	105	84	75
Moment of inertia J ($\times 10^{-4}$ kg·m ²) [J (oz·in ²)]	Standard	11.9 (65.1)	17.8 (97.3)	38.3 (209)	75.0 (410)	97.0 (530)	154 (842)
	With electromagnetic brake	14.0 (76.5)	20.0 (109)	47.9 (262)	84.7 (463)	107 (585)	164 (897)
Recommended load to motor inertia moment ratio		Maximum of 15 times the servo motor's inertia moment (Note 3)					
Speed/position detector		18-bit encoder (resolution: 262144 p/rev)					
Attachments		— (Motors with an oil seal are available (HF-SP□U))					
Insulation class		Class F					
Structure		Totally enclosed non ventilated (IP rating: IP67) (Note 4)					
Environment (Note 7)	Ambient temperature	0 to 40°C (32 to 104°F) (non freezing), storage: -15 to 70°C (5 to 158°F) (non freezing)					
	Ambient humidity	80% RH maximum (non condensing), storage: 90% RH maximum (non condensing)					
	Atmosphere	Indoors (no direct sunlight); no corrosive gas, inflammable gas, oil mist or dust					
	Elevation	1000m or less above sea level					
	Vibration (Note 5)	X: 24.5m/s ² Y: 24.5m/s ²		X: 24.5m/s ² Y: 49m/s ²		X: 24.5m/s ² Y: 29.4m/s ²	
Mass (kg [lb])	Standard	6.5 (15)	8.3 (19)	12 (27)	19 (42)	22 (49)	32 (71)
	With electromagnetic brake	8.5 (19)	10.3 (23)	18 (40)	25 (56)	28 (62)	38 (84)

Notes: 1. The power supply capacity varies depending on the power supply's impedance.

2. The regenerative braking frequency shows the permissible frequency when the motor, without a load and an optional regeneration unit, decelerates from the rated speed to a stop. When a load is connected; however, the value will be the table value/(m+1), where m=load inertia moment/motor inertia moment. When the operating speed exceeds the rated speed, the regenerative braking frequency is inversely proportional to the square of (operating speed/rated speed). If the operating speed changes frequently or when the regeneration is constant (as with vertical feeds), find the regenerative heating value (W) in operation. Provisions must be made to keep this heating value below the tolerable regenerative power (W). Optimal regenerative resistor varies for each system. Select the most suitable regenerative resistor by using the capacity selection software. Refer to the section "Options ● Optional regeneration unit" in this catalog for details on the tolerable regenerative power (W).

3. Contact your local sales office if the load to motor inertia moment ratio exceeds the value in the table.

4. The shaft-through portion is excluded.

5. The vibration direction is shown in the diagram to the right. The numeric value indicates the maximum value of the component (commonly the bracket in the opposite direction of the motor shaft). Fretting of the bearing occurs easily when the motor stops, so maintain vibration to approximately one-half of the allowable value.

6. To use MR-J3-200A or smaller with the HF-SP 1000r/min series, the servo amplifier's software version must be A4 or above.

7. In the environment where the servo motor is exposed to oil mist, oil and/or water, a standard specification servo motor may not be usable. Contact your local sales office for more details.

8. When unbalanced torque is generated, such as in a vertical lift machine, it is recommended that the unbalanced torque of the machine be kept under 70% of the motor's rated torque.



HF-SP 1000r/min Series Servo Motor Torque Characteristics

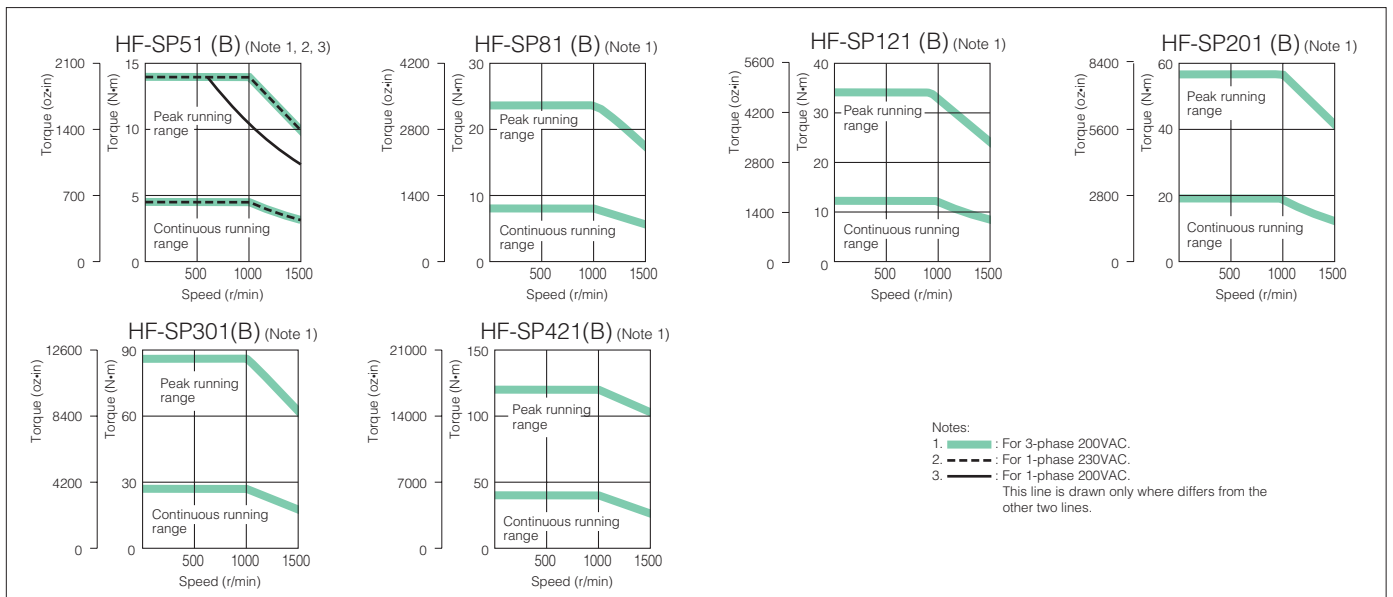

Model designation

Servo motors

Servo amplifiers

Options

Peripheral equipment

MR-J3-B Safety series

MR-J3W series

Servo support software

Cautions

Warranty

Global FA centers

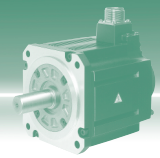

HF-SP 2000r/min Series Servo Motor Specifications (200VAC Class)

Servo motor series		HF-SP 2000r/min series (Medium inertia, medium capacity)						
Servo motor model HF-SP		52(B)	102(B)	152(B)	202(B)	352(B)	502(B)	702(B)
Compatible servo amplifier model MR-J3-		60A/B(-RJ006)/T	100A/B(-RJ006)/T	200AN/BN(-RJ006)/TN	350A/B(-RJ006)/T	500A/B(-RJ006)/T	700A/B(-RJ006)/T	
Power supply capacity (Note 1) (kVA)		1.0	1.7	2.5	3.5	5.5	7.5	10
Continuous running duty	Rated output (kW)	0.5	1.0	1.5	2.0	3.5	5.0	7.0
	Rated torque (Note 7) (N·m [oz·in])	2.39 (338)	4.77 (675)	7.16 (1010)	9.55 (1350)	16.7 (2360)	23.9 (3380)	33.4 (4730)
Maximum torque (N·m [oz·in])		7.16 (1010)	14.3 (2020)	21.5 (3040)	28.6 (4050)	50.1 (7090)	71.6 (10100)	100 (14200)
Rated speed (r/min)		2000						
Maximum speed (r/min)		3000						
Permissible instantaneous speed (r/min)		3450						
Power rate at continuous rated torque (kW/s)		9.34	19.2	28.8	23.8	37.2	58.8	72.5
Rated current (A)		2.9	5.3	8.0	10	16	24	33
Maximum current (A)		8.7	15.9	24	30	48	72	99
Regenerative braking frequency (times/min) (Note 2)		60	62	152	71	33	37	31
Moment of inertia J ($\times 10^{-4} \text{kg}\cdot\text{m}^2$) [J (oz·in ²)]	Standard	6.1 (33.4)	11.9 (65.1)	17.8 (97.3)	38.3 (209)	75.0 (410)	97.0 (530)	154 (842)
	With electromagnetic brake	8.3 (45.4)	14.0 (76.5)	20.0 (109)	47.9 (262)	84.7 (463)	107 (585)	164 (897)
Recommended load to motor inertia moment ratio		Maximum of 15 times the servo motor's inertia moment (Note 3)						
Speed/position detector		18-bit encoder (resolution: 262144 p/rev)						
Attachments		— (Motors with an oil seal are available (HF-SP□J))						
Insulation class		Class F						
Structure		Totally enclosed non ventilated (IP rating: IP67) (Note 4)						
Environment (Note 6)	Ambient temperature	0 to 40°C (32 to 104°F) (non freezing), storage: -15 to 70°C (5 to 158°F) (non freezing)						
	Ambient humidity	80% RH maximum (non condensing), storage: 90% RH maximum (non condensing)						
	Atmosphere	Indoors (no direct sunlight); no corrosive gas, inflammable gas, oil mist or dust						
	Elevation	1000m or less above sea level						
	Vibration (Note 5)	X: 24.5m/s ² Y: 24.5m/s ²		X: 24.5m/s ² Y: 49m/s ²		X: 24.5m/s ² Y: 29.4m/s ²		
Mass (kg [lb])	Standard	4.8 (11)	6.5 (15)	8.3 (19)	12 (27)	19 (42)	22 (49)	32 (71)
	With electromagnetic brake	6.7 (15)	8.5 (19)	10.3 (23)	18 (40)	25 (56)	28 (62)	38 (84)

Notes:1. The power supply capacity varies depending on the power supply's impedance.

2. The regenerative braking frequency shows the permissible frequency when the motor, without a load and an optional regeneration unit, decelerates from the rated speed to a stop. When a load is connected; however, the value will be the table value/(m+1), where m=load inertia moment/motor inertia moment. When the operating speed exceeds the rated speed, the regenerative braking frequency is inversely proportional to the square of (operating speed/rated speed). If the operating speed changes frequently or when the regeneration is constant (as with vertical feeds), find the regenerative heating value (W) in operation. Provisions must be made to keep this heating value below the tolerable regenerative power (W). Optimal regenerative resistor varies for each system. Select the most suitable regenerative resistor by using the capacity selection software. Refer to the section "Options ● Optional regeneration unit" in this catalog for details on the tolerable regenerative power (W).

HF-SP 2000r/min Series Servo Motor Torque Characteristics (200VAC Class)

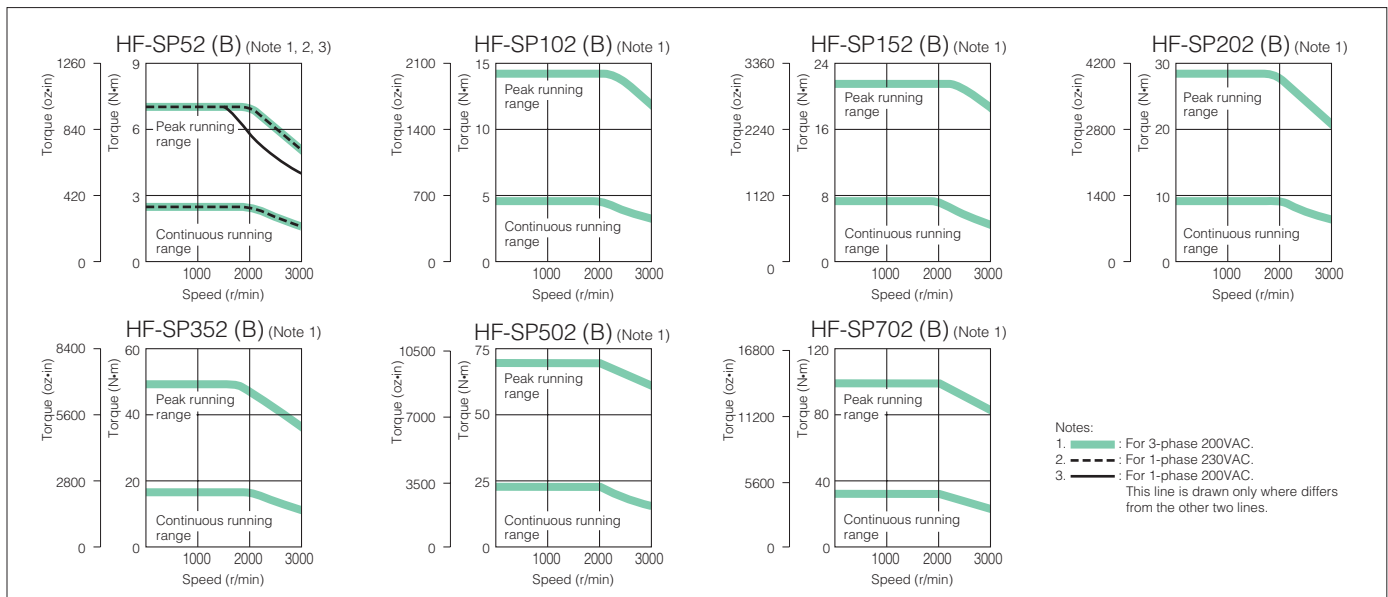

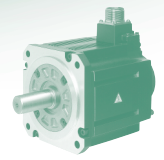

HF-SP 2000r/min Series Servo Motor Specifications (400VAC Class)

HF-SP 2000r/min series (Medium inertia, medium capacity)						
524(B)	1024(B)	1524(B)	2024(B)	3524(B)	5024(B)	7024(B)
60A4/B4(-RJ006)/T4	100A4/B4(-RJ006)/T4	200A4/B4(-RJ006)/T4		350A4/B4(-RJ006)/T4	500A4/B4(-RJ006)/T4	700A4/B4(-RJ006)/T4
1.0	1.7	2.5	3.5	5.5	7.5	10
0.5	1.0	1.5	2.0	3.5	5.0	7.0
2.39 (338)	4.77 (675)	7.16 (1010)	9.55 (1350)	16.7 (2360)	23.9 (3380)	33.4 (4730)
7.16 (1010)	14.3 (2020)	21.5 (3040)	28.6 (4050)	50.1 (7090)	71.6 (10100)	100 (14200)
2000						
3000						
3450						
9.34	19.2	28.8	23.8	37.2	58.8	72.5
1.5	2.9	4.1	5.0	8.4	12	16
4.5	8.7	12	15	25	36	48
90	46	154	72	37	34	28
6.1 (33.4)	11.9 (65.1)	17.8 (97.3)	38.3 (209)	75.0 (410)	97.0 (530)	154 (842)
8.3 (45.4)	14.0 (76.5)	20.0 (109)	47.9 (262)	84.7 (463)	107 (585)	164 (897)
Maximum of 15 times the servo motor's inertia moment (Note 3)						
18-bit encoder (resolution: 262144 p/rev)						
— (Motors with an oil seal are available (HF-SP□J))						
Class F						
Totally enclosed non ventilated (IP rating: IP67) (Note 4)						
0 to 40°C (32 to 104°F) (non freezing), storage: -15 to 70°C (5 to 158°F) (non freezing)						
80% RH maximum (non condensing), storage: 90% RH maximum (non condensing)						
Indoors (no direct sunlight); no corrosive gas, inflammable gas, oil mist or dust						
1000m or less above sea level						
X: 24.5m/s ² Y: 24.5m/s ²		X: 24.5m/s ² Y: 49m/s ²			X: 24.5m/s ² Y: 29.4m/s ²	
4.8 (11)	6.7 (15)	8.5 (19)	13 (29)	19 (42)	22 (49)	32 (71)
6.7 (15)	8.6 (19)	11 (25)	19 (42)	25 (56)	28 (62)	38 (84)

- Contact your local sales office if the load to motor inertia moment ratio exceeds the value in the table.
- The shaft-through portion is excluded.
- The vibration direction is shown in the diagram to the right. The numeric value indicates the maximum value of the component (commonly the bracket in the opposite direction of the motor shaft). Fretting of the bearing occurs easily when the motor stops, so maintain vibration to approximately one-half of the allowable value.
- In the environment where the servo motor is exposed to oil mist, oil and/or water, a standard specification servo motor may not be usable. Contact your local sales office for more details.
- When unbalanced torque is generated, such as in a vertical lift machine, it is recommended that the unbalanced torque of the machine be kept under 70% of the motor's rated torque.

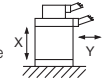

HF-SP 2000r/min Series Servo Motor Torque Characteristics (400VAC Class)

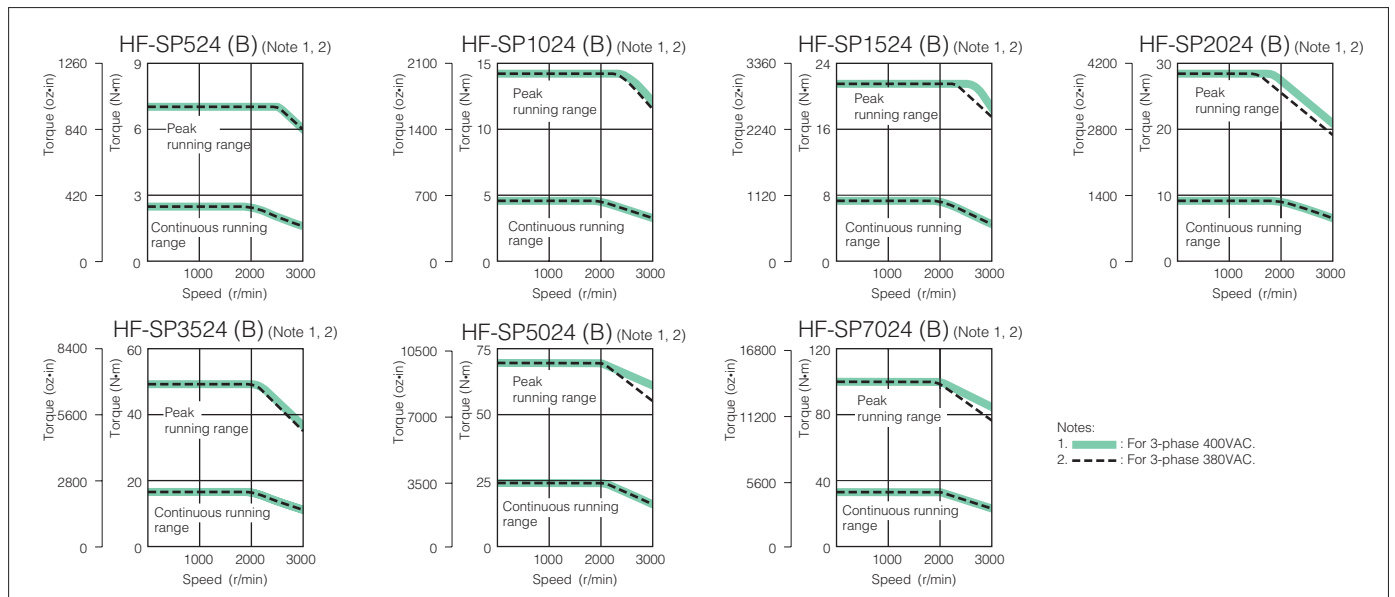

Model designation
 Servo motors
 Servo amplifiers
 Options
 Peripheral equipment
 MR-J3-BSafety series
 MR-J3W series
 Servo support software
 Cautions
 Warranty
 Global FA centers

MELSERVO-J3

HF-JP 3000r/min Series Servo Motor Specifications (200VAC Class)

Servo motor series		HF-JP 3000r/min series (Low inertia, medium capacity)			
Servo motor model HF-JP		53(B)	73(B)	103(B)	153(B)
Compatible servo amplifier model MR-J3-		60A/B(-RJ006)/T	70A/B(-RJ006)/T	100A/B(-RJ006)/T	200AN/BN(-RJ006)/TN
Power supply capacity (Note 1) (kVA)		1.0	1.3	1.7	2.5
Continuous running duty	Rated output (kW)	0.5	0.75	1.0	1.5
	Rated torque (Note 10) (N·m [oz·in])	1.59 (225)	2.39 (338)	3.18 (450)	4.77 (675)
Maximum torque (N·m [oz·in])		4.77 (675)	7.16 (1010)	9.55 (1350)	14.3 (2020)
Rated speed (r/min)		3000			
Maximum speed (r/min)		6000			
Permissible instantaneous speed (r/min)		6900			
Power rate at continuous rated torque (kW/s)		16.7	27.3	38.2	60.2
Rated current (A)		3.0	5.6	5.6	10.6
Maximum current (A)		9.0	17	17	32
Regenerative braking frequency (times/min) (Note 2)		67	98	76	271
Moment of inertia J (x10 ⁻⁴ kg·m ²) [J (oz·in ²)]	Standard	1.52 (8.31)	2.09 (11.4)	2.65 (14.5)	3.79 (20.7)
	With electromagnetic brake	2.02 (11.0)	2.59 (14.2)	3.15 (17.2)	4.29 (23.5)
Recommended load to motor inertia moment ratio		Maximum of 10 times the servo motor's inertia moment (Note 3)			
Speed/position detector		18-bit encoder (resolution: 262144 p/rev)			
Attachments		Oil seal			
Insulation class		Class F			
Structure		Totally enclosed non ventilated (IP rating: IP67) (Note 4)			
Environment (Note 6)	Ambient temperature	0 to 40°C (32 to 104°F) (non freezing), storage: -15 to 70°C (5 to 158°F) (non freezing)			
	Ambient humidity	80% RH maximum (non condensing), storage: 90% RH maximum (non condensing)			
	Atmosphere	Indoors (no direct sunlight); no corrosive gas, inflammable gas, oil mist or dust			
	Elevation	1000m or less above sea level			
Mass (kg [lb])	Standard	3.0 (6.7)	3.7 (8.2)	4.5 (10)	5.9 (13)
	With electromagnetic brake	4.4 (9.7)	5.1 (12)	5.9 (13)	7.3 (16)
With increased maximum torque: (Note 8)	Compatible servo amplifier model MR-J3-	100A/B(-RJ006)/T (Note 11)	200AN/BN(-RJ006)/TN (Note 11)	200AN/BN(-RJ006)/TN (Note 11)	350A/B(-RJ006)/T (Note 11)
	Maximum torque (N·m [oz·in])	6.37 (902)	9.55 (1350)	12.7 (1800)	19.1 (2700)
	Maximum current (A)	12	23	23	43
	Regenerative braking frequency (times/min) (Note 2)	137	511	396	271

Notes: 1. The power supply capacity varies depending on the power supply's impedance.

2. The regenerative braking frequency shows the permissible frequency when the motor, without a load and an optional regeneration unit, decelerates from the rated speed to a stop. When a load is connected; however, the value will be the table value/(m+1), where m=load inertia moment/motor inertia moment. When the operating speed exceeds the rated speed, the regenerative braking frequency is inversely proportional to the square of (operating speed/rated speed). If the operating speed changes frequently or when the regeneration is constant (as with vertical feeds), find the regenerative heating value (W) in operation. Provisions must be made to keep this heating value below the tolerable regenerative power (W). Optimal regenerative resistor varies for each system. Select the most suitable regenerative resistor by using the capacity selection software. Refer to the section "Options ● Optional regeneration unit" in this catalog for details on the tolerable regenerative power (W).

3. Contact your local sales office if the load to motor inertia moment ratio exceeds the value in the table.

4. The shaft-through portion is excluded.

HF-JP 3000r/min Series Servo Motor Torque Characteristics (200VAC Class)

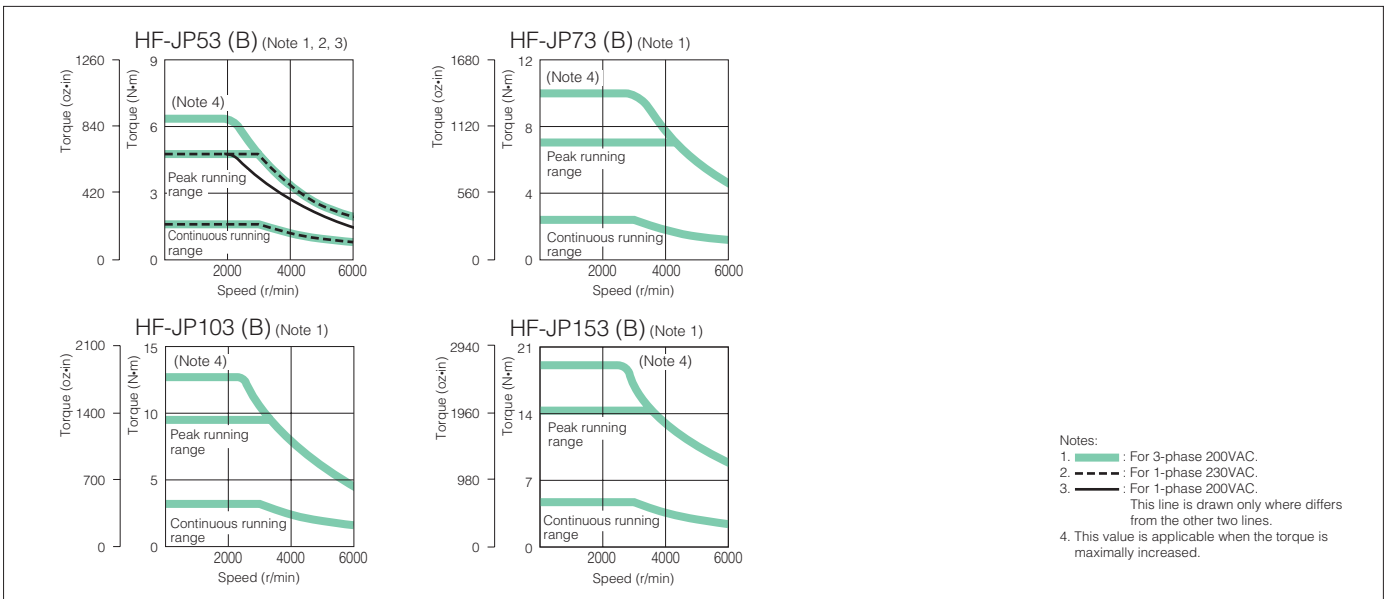

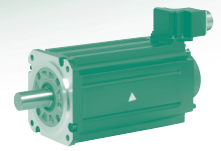

HF-JP 3000r/min series (Low inertia, medium capacity)				
203(B)	353(B)	503(B)	703(B)	903(B)
200AN/BN(-RJ006)/TN	350A/B(-RJ006)/T	500A/B(-RJ006)/T	700A/B(-RJ006)/T	11KA/B(-RJ006)/T
3.5	5.5	7.5	10	13
2.0	3.3 <3.5> (Note 7)	5.0	7.0	9.0
6.37 (902)	10.5 (1490) <11.1 (1570)> (Note 7)	15.9 (2250)	22.3 (3160)	28.6 (4050)
19.1 (2700)	32.0 (4530)	47.7 (6750)	66.8 (9460)	85.8 (12100)
3000				
6000			5000	
6900			5750	
82.4	83.5	133	115	147
10.6	16.6 <17.6> (Note 7)	27	34	41
32	51	81	103	134
206	73	68	56	204 (Note 9)
4.92 (26.9)	13.2 (72.2)	19.0 (104)	43.3 (237)	55.8 (305)
5.42 (29.6)	15.4 (84.2)	21.2 (116)	52.9 (289)	65.4 (358)
Maximum of 10 times the servo motor's inertia moment (Note 3)				
18-bit encoder (resolution: 262144 p/rev)				
Oil seal				
Class F				
Totally enclosed non ventilated (IP rating: IP67) (Note 4)				
0 to 40°C (32 to 104°F) (non freezing), storage: -15 to 70°C (5 to 158°F) (non freezing)				
80% RH maximum (non condensing), storage: 90% RH maximum (non condensing)				
Indoors (no direct sunlight); no corrosive gas, inflammable gas, oil mist or dust				
1000m or less above sea level				
X: 24.5m/s ² Y: 24.5m/s ²			X: 24.5m/s ² Y: 29.4m/s ²	
7.5 (17)	13 (29)	18 (40)	29 (64)	36 (80)
8.9 (20)	15 (33)	20 (44)	35 (78)	42 (93)
350A/B(-RJ006)/T (Note 11)	500A/B(-RJ006)/T (Note 11)	700A/B(-RJ006)/T (Note 11)	-	-
25.5 (3610)	44.6 (6320)	63.7 (9020)	-	-
43	71	108	-	-
206	98	89	-	-

- The vibration direction is shown in the diagram to the right. The numeric value indicates the maximum value of the component (commonly the bracket in the opposite direction of the motor shaft). Fretting of the bearing occurs easily when the motor stops, so maintain vibration to approximately one-half of the allowable value.
- In the environment where the servo motor is exposed to oil mist, oil and/or water, a standard specification servo motor may not be usable. Contact your local sales office for more details.
- Value indicated in < > is applicable when connected to MR-J3-500A/B(-RJ006)/T servo amplifier.
- The value is applicable when the external regenerative resistors, GRZG400-□Ω (standard accessory) are used with cooling fans (2 units of 92 X 92mm, minimum air flow: 1.0m³/min). Note that change in parameter No. PA02 is required.
- The maximum torque can be increased from 300% to 400% of the rated torque by changing the servo amplifier to be combined. Refer to "Combinations for Increasing the Maximum Torque" in this catalog for more details.
- When unbalanced torque is generated, such as in a vertical lift machine, it is recommended that the unbalanced torque of the machine be kept under 70% of the motor's rated torque.
- Contact your local sales office for the unlisted servo amplifiers which enable increasing the maximum torque.

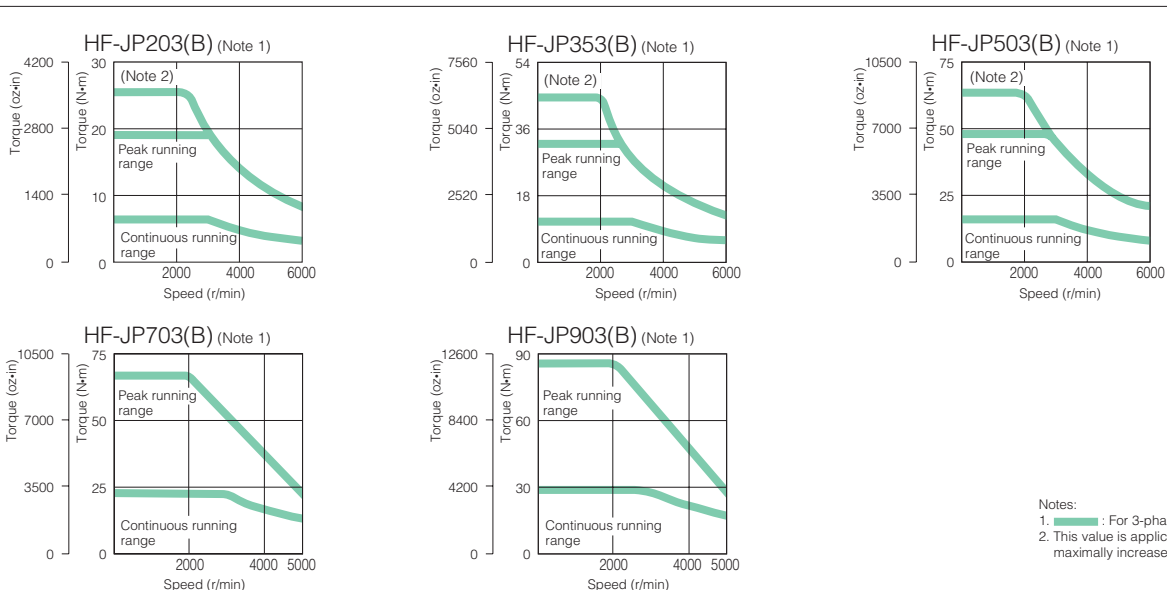
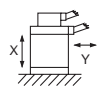

Notes:
 1. : For 3-phase 200VAC.
 2. This value is applicable when the torque is maximally increased.

Model designation
 Servo motors
 Servo amplifiers
 Options
 Peripheral equipment
 MR-J3-B Safety
 MR-J3W series
 Servo support software
 Cautions
 Warranty
 Global FA centers

MELSERVO-J3

HF-JP 3000r/min Series Servo Motor Specifications (400VAC Class)

Servo motor series		HF-JP 3000r/min series (Low inertia, medium capacity)			
Servo motor model HF-JP		534(B)	734(B)	1034(B)	1534(B)
Compatible servo amplifier model MR-J3-		60A4/B4(-RJ006)/T4	100A4/B4(-RJ006)/T4		200A4/B4(-RJ006)/T4
Power supply capacity (Note 1) (kVA)		1.0	1.3	1.7	2.5
Continuous running duty	Rated output (kW)	0.5	0.75	1.0	1.5
	Rated torque (Note 10) (N·m [oz·in])	1.59 (225)	2.39 (338)	3.18 (450)	4.77 (675)
Maximum torque (N·m [oz·in])		4.77 (675)	7.16 (1010)	9.55 (1350)	14.3 (2020)
Rated speed (r/min)		3000			
Maximum speed (r/min)		6000			
Permissible instantaneous speed (r/min)		6900			
Power rate at continuous rated torque (kW/s)		16.7	27.3	38.2	60.2
Rated current (A)		1.5	2.8	2.8	5.4
Maximum current (A)		4.5	8.4	8.4	17
Regenerative braking frequency (times/min) (Note 2)		99	72	56	265
Moment of inertia J ($\times 10^{-4}$ kg·m ²) [J (oz·in ²)]	Standard	1.52 (8.31)	2.09 (11.4)	2.65 (14.5)	3.79 (20.7)
	With electromagnetic brake	2.02 (11.0)	2.59 (14.2)	3.15 (17.2)	4.29 (23.5)
Recommended load to motor inertia moment ratio		Maximum of 10 times the servo motor's inertia moment (Note 3)			
Speed/position detector		18-bit encoder (resolution: 262144 p/rev)			
Attachments		Oil seal			
Insulation class		Class F			
Structure		Totally enclosed non ventilated (IP rating: IP67) (Note 4)			
Environment (Note 6)	Ambient temperature	0 to 40°C (32 to 104°F) (non freezing), storage: -15 to 70°C (5 to 158°F) (non freezing)			
	Ambient humidity	80% RH maximum (non condensing), storage: 90% RH maximum (non condensing)			
	Atmosphere	Indoors (no direct sunlight); no corrosive gas, inflammable gas, oil mist or dust			
	Elevation	1000m or less above sea level			
Mass (kg [lb])	Standard	3.0 (6.7)	3.7 (8.2)	4.5 (10)	5.9 (13)
	With electromagnetic brake	4.4 (9.7)	5.1 (12)	5.9 (13)	7.3 (16)
With increased maximum torque: (Note 8)	Compatible servo amplifier model MR-J3-	100A4/B4(-RJ006)/T4 (Note 11)	200A4/B4(-RJ006)/T4 (Note 11)	200A4/B4(-RJ006)/T4 (Note 11)	350A4/B4(-RJ006)/T4 (Note 11)
	Maximum torque (N·m [oz·in])	6.37 (902)	9.55 (1350)	12.7 (1800)	19.1 (2700)
	Maximum current (A)	6.0	12	12	22
	Regenerative braking frequency (times/min) (Note 2)	100	489	382	275

Notes: 1. The power supply capacity varies depending on the power supply's impedance.

2. The regenerative braking frequency shows the permissible frequency when the motor, without a load and an optional regeneration unit, decelerates from the rated speed to a stop. When a load is connected; however, the value will be the table value/(m+1), where m=load inertia moment/motor inertia moment. When the operating speed exceeds the rated speed, the regenerative braking frequency is inversely proportional to the square of (operating speed/rated speed). If the operating speed changes frequently or when the regeneration is constant (as with vertical feeds), find the regenerative heating value (W) in operation. Provisions must be made to keep this heating value below the tolerable regenerative power (W). Optimal regenerative resistor varies for each system. Select the most suitable regenerative resistor by using the capacity selection software. Refer to the section "Options ● Optional regeneration unit" in this catalog for details on the tolerable regenerative power (W).

3. Contact your local sales office if the load to motor inertia moment ratio exceeds the value in the table.

4. The shaft-through portion is excluded.

HF-JP 3000r/min Series Servo Motor Torque Characteristics (400VAC Class)

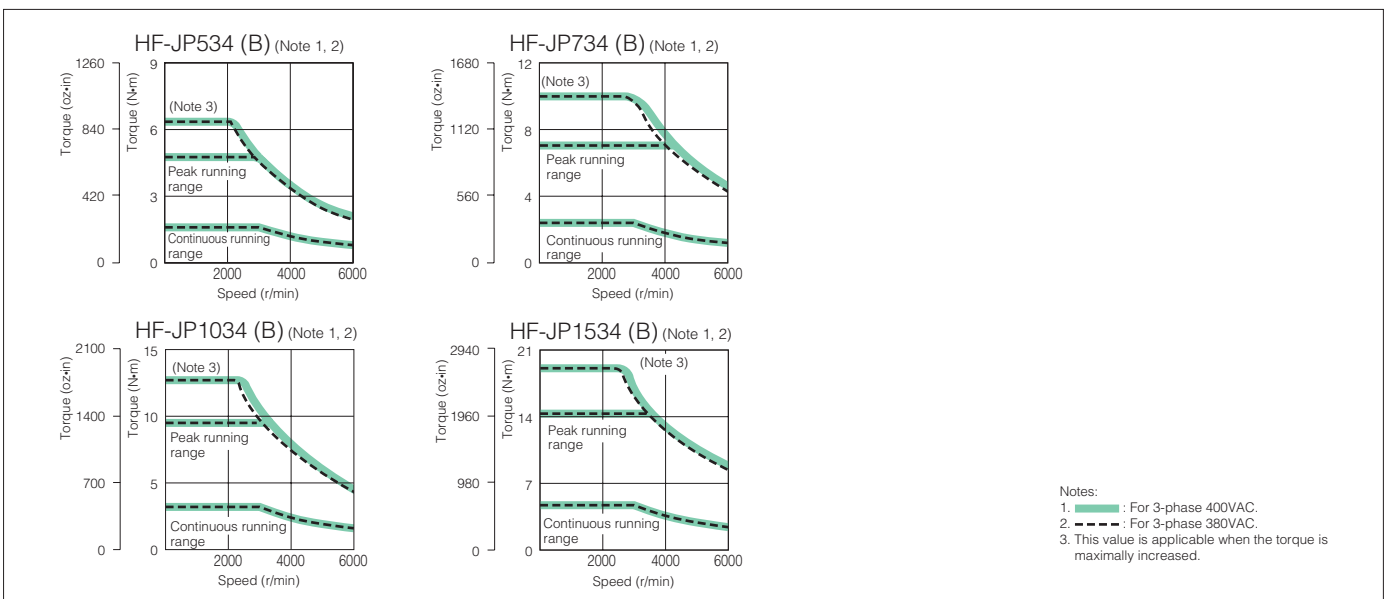

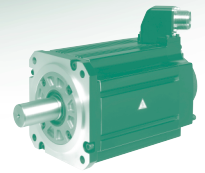

HF-JP 3000r/min series (Low inertia, medium capacity)				
2034(B)	3534(B)	5034(B)	7034(B)	9034(B)
200A4/B4(-RJ006)/T4	350A4/B4(-RJ006)/T4	500A4/B4(-RJ006)/T4	700A4/B4(-RJ006)/T4	11KA4/B4(-RJ006)/T4
3.5	5.5	7.5	10	13
2.0	3.3 <3.5> (Note 7)	5.0	7.0	9.0
6.37 (902)	10.5 (1490) <11.1 (1570)> (Note 7)	15.9 (2250)	22.3 (3160)	28.6 (4050)
19.1 (2700)	32.0 (4530)	47.7 (6750)	66.8 (9460)	85.8 (12100)
	3000		5000	
	6000		5000	
	6900		5750	
82.4	83.5	133	115	147
5.4	8.3<8.8>(Note 7)	14	17	21
17	26	41	52	67
203	75	68	56	205 (Note 9)
4.92 (26.9)	13.2 (72.2)	19.0 (104)	43.3 (237)	55.8 (305)
5.42 (29.6)	15.4 (84.2)	21.2 (116)	52.9 (289)	65.4 (358)
Maximum of 10 times the servo motor's inertia moment (Note 3)				
18-bit encoder (resolution: 262144 p/rev)				
Oil seal				
Class F				
Totally enclosed non ventilated (IP rating: IP67) (Note 4)				
0 to 40°C (32 to 104°F) (non freezing), storage: -15 to 70°C (5 to 158°F) (non freezing)				
80% RH maximum (non condensing), storage: 90% RH maximum (non condensing)				
Indoors (no direct sunlight); no corrosive gas, inflammable gas, oil mist or dust				
1000m or less above sea level				
X: 24.5m/s ² Y: 24.5m/s ²			X: 24.5m/s ² Y: 29.4m/s ²	
7.5 (17)	13 (29)	18 (40)	29 (64)	36 (80)
8.9 (20)	15 (33)	20 (44)	35 (78)	42 (93)
350A4/B4(-RJ006)/T4 (Note 11)	500A4/B4(-RJ006)/T4 (Note 11)	700A4/B4(-RJ006)/T4 (Note 11)	-	-
25.5 (3610)	44.6 (6320)	63.7 (9020)	-	-
22	36	54	-	-
209	98	89	-	-

- The vibration direction is shown in the diagram to the right. The numeric value indicates the maximum value of the component (commonly the bracket in the opposite direction of the motor shaft). Fretting of the bearing occurs easily when the motor stops, so maintain vibration to approximately one-half of the allowable value.
- In the environment where the servo motor is exposed to oil mist, oil and/or water, a standard specification servo motor may not be usable. Contact your local sales office for more details.
- Value indicated in < > is applicable when connected to MR-J3-500A4/B4(-RJ006)/T4 servo amplifier.
- The value is applicable when the external regenerative resistors, GRZG400-□Ω (standard accessory) are used with cooling fans (2 units of 92 × 92mm, minimum air flow: 1.0m³/min). Note that change in parameter No. PA02 is required.
- The maximum torque can be increased from 300% to 400% of the rated torque by changing the servo amplifier to be combined. Refer to "Combinations for Increasing the Maximum Torque" in this catalog for more details.
- When unbalanced torque is generated, such as in a vertical lift machine, it is recommended that the unbalanced torque of the machine be kept under 70% of the motor's rated torque.
- Contact your local sales office for the unlisted servo amplifiers which enable increasing the maximum torque.

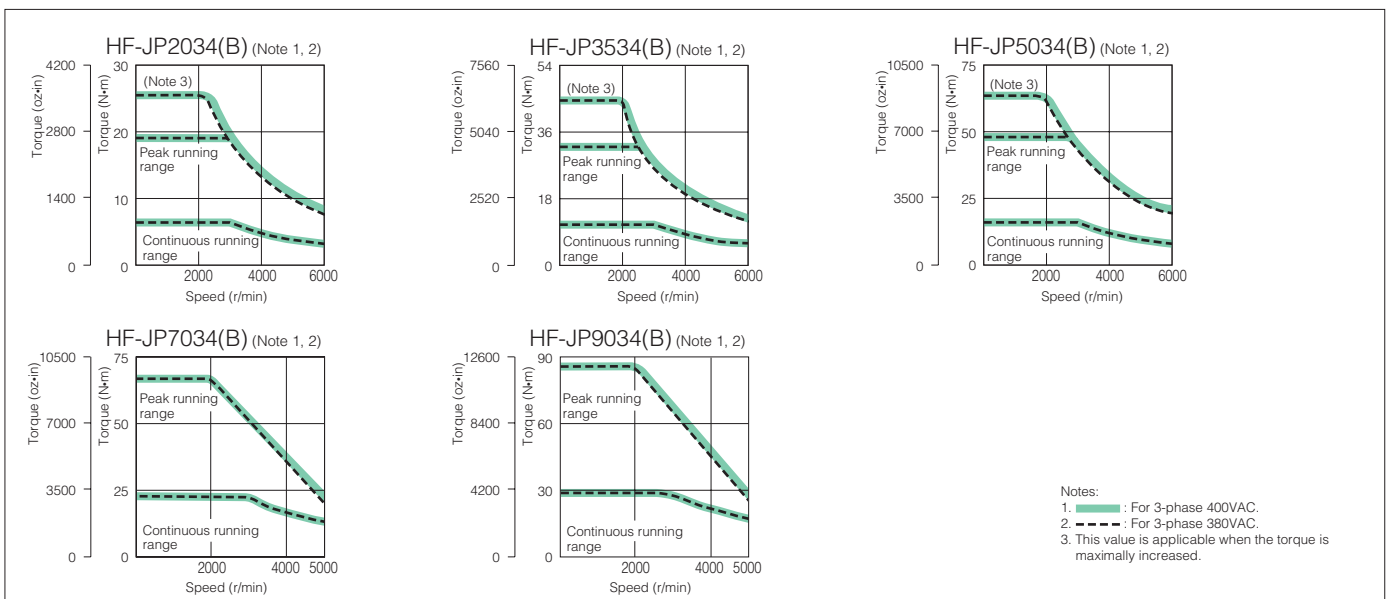
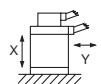

Model designation
Servo motors
Servo amplifiers
Options
Peripheral equipment
MR-J3-B Safety
MR-J3W series
Servo support software
Cautions
Warranty
Global FA centers

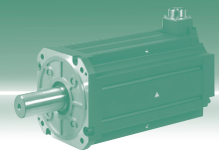

HF-JP 1500r/min Series Servo Motor Specifications (200VAC/400VAC Class)

Servo motor series		HF-JP 1500r/min series (Low inertia, large capacity) (200VAC)		HF-JP 1500r/min series (Low inertia, large capacity) (400VAC)	
Servo motor model HF-JP		11K1M(B)	15K1M(B)	11K1M4(B)	15K1M4(B)
Compatible servo amplifier model (Note 8) MR-J3-		11KA/B/T-LR (Note 10)	15KA/B/T-LR (Note 10)	11KA4/B4/T4-LR (Note 10)	15KA4/B4/T4-LR (Note 10)
Power supply capacity (Note 1) (kVA)		16	22	16	22
Continuous running duty	Rated output (kW)	11	15	11	15
	Rated torque (Note 9) (N·m [oz·in])	70 (9910)	95.5 (13500)	70 (9910)	95.5 (13500)
Maximum torque (N·m [oz·in])		210 (29700)	286 (40500)	210 (29700)	286 (40500)
Rated speed (r/min)		1500			
Maximum speed (r/min)		3000			
Permissible instantaneous speed (r/min)		3450			
Power rate at continuous rated torque (kW/s)		223	290	223	290
Rated current (A)		60	76	32	38
Maximum current (A)		200	246	100	123
Regenerative braking frequency (times/min) (Note 2, 6)		143	162	143	162
Moment of inertia J ($\times 10^{-4}$ kg·m ²) [J (oz·in ²)]	Standard	220 (1200)	315 (1720)	220 (1200)	315 (1720)
	With electromagnetic brake	240 (1310)	336 (1840)	240 (1310)	336 (1840)
Recommended load to motor inertia moment ratio		Maximum of 10 times the servo motor's inertia moment (Note 3)			
Speed/position detector		18-bit encoder (resolution: 262144 p/rev)			
Attachments		Oil seal			
Insulation class		Class F			
Structure		Totally enclosed non ventilated (IP rating: IP67) (Note 4)			
Environment (Note 7)	Ambient temperature	0 to 40°C (32 to 104°F) (non freezing), storage: -15 to 70°C (5 to 158°F) (non freezing)			
	Ambient humidity	80% RH maximum (non condensing), storage: 90% RH maximum (non condensing)			
	Atmosphere	Indoors (no direct sunlight); no corrosive gas, inflammable gas, oil mist or dust			
	Elevation	1000m or less above sea level			
	Vibration (Note 5)	X: 24.5m/s ² Y: 24.5m/s ²			
Mass (kg [lb])	Standard	62 (140)	86 (190)	62 (140)	86 (190)
	With electromagnetic brake	74 (165)	97 (215)	74 (165)	97 (215)

- Notes: 1. The power supply capacity varies depending on the power supply's impedance.
 2. The regenerative braking frequency shows the permissible frequency when the motor, without a load and an optional regeneration unit, decelerates from the rated speed to a stop. When a load is connected; however, the value will be the table value/(m+1), where m=load inertia moment/motor inertia moment. When the operating speed exceeds the rated speed, the regenerative braking frequency is inversely proportional to the square of (operating speed/rated speed). If the operating speed changes frequently or when the regeneration is constant (as with vertical feeds), find the regenerative heating value (W) in operation. Provisions must be made to keep this heating value below the tolerable regenerative power (W). Optional regenerative resistor varies for each system. Select the most suitable regenerative resistor by using the capacity selection software. Refer to the section "Options ● Optional regeneration unit" in this catalog for details on the tolerable regenerative power (W).
 3. Contact your local sales office if the load to motor inertia moment ratio exceeds the value in the table.
 4. The shaft-through portion is excluded.
 5. The vibration direction is shown in the diagram to the right. The numeric value indicates the maximum value of the component (commonly the bracket in the opposite direction of the motor shaft). Fretting of the bearing occurs easily when the motor stops, so maintain vibration to approximately one-half of the allowable value.
 6. The value is applicable when the external regenerative resistors, GRZG400-□Ω (standard accessory) are used with cooling fans (2 units of 92 X 92mm, minimum air flow: 1.0m³/min). Note that change in parameter No. PA02 is required.
 7. In the environment where the servo motor is exposed to oil mist, oil and/or water, a standard specification servo motor may not be usable. Contact your local sales office for more details.
 8. Contact your local sales office for fully closed loop control compatible servo amplifier.
 9. When unbalanced torque is generated, such as in a vertical lift machine, it is recommended that the unbalanced torque of the machine be kept under 70% of the motor's rated torque.
 10. Use a dedicated servo amplifier MR-J3-□A(4)/B(4)/T(4)-LR/LW for HF-JP11K1M(4) and HF-JP15K1M(4). These servo motors cannot be used with any other servo amplifiers without "-LR/LW".



HF-JP 1500r/min Series Servo Motor Torque Characteristics (200VAC/400VAC Class)

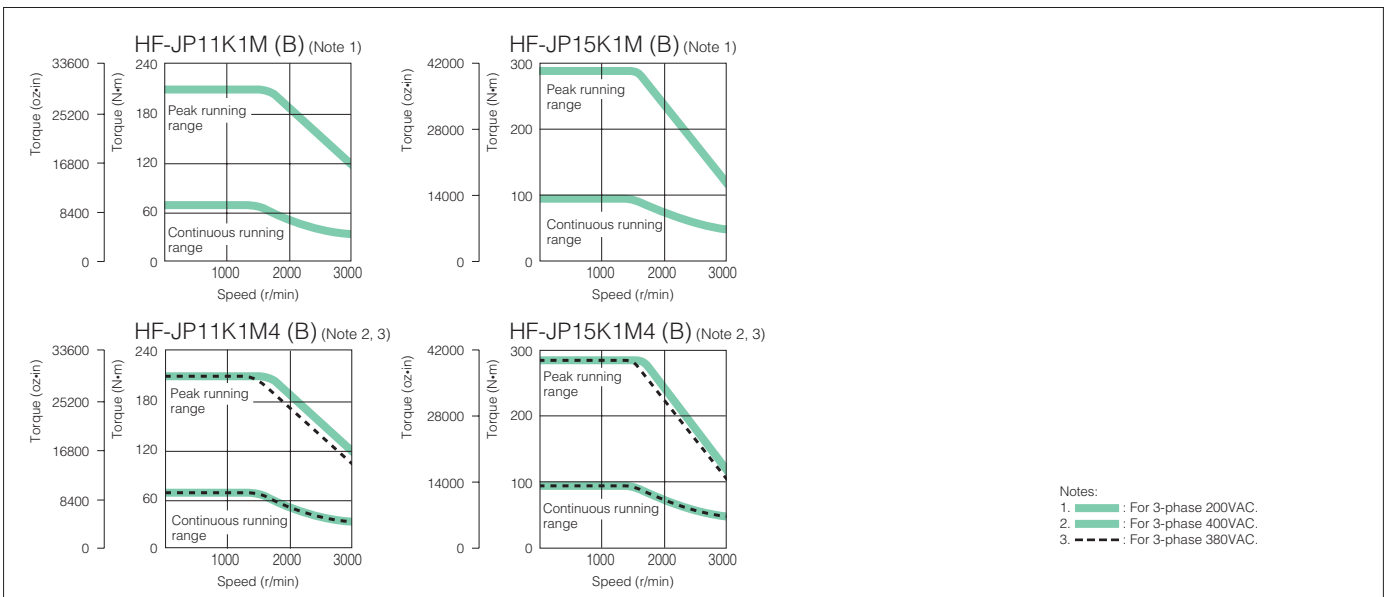

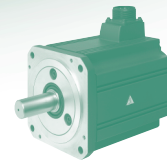

HC-LP Series Servo Motor Specifications

Servo motor series		HC-LP series (Low inertia, medium capacity)				
Servo motor model HC-LP		52(B)	102(B)	152(B)	202(B)	302(B)
Compatible servo amplifier model MR-J3-		60A/B(-RJ006)/T	100A/B(-RJ006)/T	200AN/BN(-RJ006)/TN	350A/B(-RJ006)/T	500A/B(-RJ006)/T
Power supply capacity (Note 1) (kVA)		1.0	1.7	2.5	3.5	4.8
Continuous running duty	Rated output (kW)	0.5	1.0	1.5	2.0	3.0
	Rated torque (Note 7) (N·m [oz·in])	2.39 (338)	4.78 (677)	7.16 (1010)	9.55 (1350)	14.3 (2020)
Maximum torque (N·m [oz·in])		7.16 (1010)	14.4 (2040)	21.6 (3060)	28.5 (4040)	42.9 (6070)
Rated speed (r/min)		2000				
Maximum speed (r/min)		3000				
Permissible instantaneous speed (r/min)		3450				
Power rate at continuous rated torque (kW/s)		18.4	49.3	79.8	41.5	56.8
Rated current (A)		3.2	5.9	9.9	14	23
Maximum current (A)		9.6	18	30	42	69
Regenerative braking frequency (times/min) (Note 2)		115	160	425	120	70
Moment of inertia J ($\times 10^{-4}$ kg·m ²) [J (oz·in ²)]	Standard	3.10 (16.9)	4.62 (25.3)	6.42 (35.1)	22.0 (120)	36.0 (197)
	With electromagnetic brake	5.20 (28.4)	6.72 (36.7)	8.52 (46.6)	32.0 (175)	46.0 (252)
Recommended load to motor inertia moment ratio		Maximum of 10 times the servo motor's inertia moment (Note 3)				
Speed/position detector		18-bit encoder (resolution: 262144 p/rev)				
Attachments		Oil seal				
Insulation class		Class F				
Structure		Totally enclosed non ventilated (IP rating: IP65) (Note 4)				
Environment (Note 6)	Ambient temperature	0 to 40°C (32 to 104°F) (non freezing), storage: -15 to 70°C (5 to 158°F) (non freezing)				
	Ambient humidity	80% RH maximum (non condensing), storage: 90% RH maximum (non condensing)				
	Atmosphere	Indoors (no direct sunlight); no corrosive gas, inflammable gas, oil mist or dust				
	Elevation	1000m or less above sea level				
	Vibration (Note 5)	X: 9.8m/s ² Y: 24.5m/s ²			X: 19.6m/s ² Y: 49m/s ²	
Mass (kg [lb])	Standard	6.5 (15)	8.0 (18)	10 (22)	21 (47)	28 (62)
	With electromagnetic brake	9.0 (20)	11 (25)	13 (29)	27 (60)	34 (75)

- Notes: 1. The power supply capacity varies depending on the power supply's impedance.
 2. The regenerative braking frequency shows the permissible frequency when the motor, without a load and an optional regeneration unit, decelerates from the rated speed to a stop. When a load is connected; however, the value will be the table value/(m+1), where m=load inertia moment/motor inertia moment. When the operating speed exceeds the rated speed, the regenerative braking frequency is inversely proportional to the square of (operating speed/rated speed). If the operating speed changes frequently or when the regeneration is constant (as with vertical feeds), find the regenerative heating value (W) in operation. Provisions must be made to keep this heating value below the tolerable regenerative power (W). Optimal regenerative resistor varies for each system. Select the most suitable regenerative resistor by using the capacity selection software. Refer to the section "Options ● Optional regeneration unit" in this catalog for details on the tolerable regenerative power (W).
 3. Contact your local sales office if the load to motor inertia moment ratio exceeds the value in the table.
 4. The shaft-through portion is excluded.
 5. The vibration direction is shown in the diagram to the right. The numeric value indicates the maximum value of the component (commonly the bracket in the opposite direction of the motor shaft). Fretting of the bearing occurs easily when the motor stops, so maintain vibration to approximately one-half of the allowable value.
 6. In the environment where the servo motor is exposed to oil mist, oil and/or water, a standard specification servo motor may not be usable. Contact your local sales office for more details.
 7. When unbalanced torque is generated, such as in a vertical lift machine, it is recommended that the unbalanced torque of the machine be kept under 70% of the motor's rated torque.



HC-LP Series Servo Motor Torque Characteristics

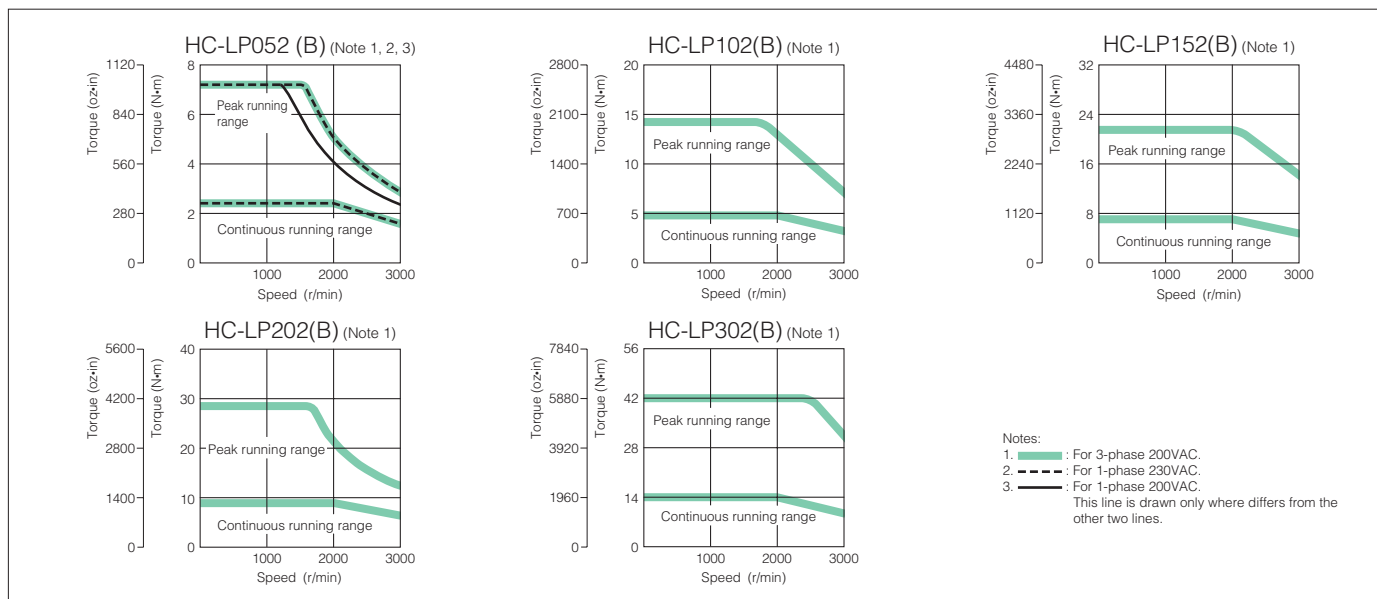

Model designation

Servo motors

Servo amplifiers

Options

Peripheral equipment

MR-J3-B Safety

MR-J3W series

Servo support software

Cautions

Warranty

Global FA centers

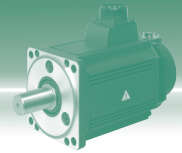

HC-RP Series Servo Motor Specifications

Servo motor series		HC-RP series (Ultra low inertia, medium capacity)				
Servo motor model HC-RP		103(B)	153(B)	203(B)	353(B)	503(B)
Compatible servo amplifier model MR-J3-		200AN/BN(-RJ006)/TN		350A/B(-RJ006)/T	500A/B(-RJ006)/T	
Power supply capacity (Note 1) (kVA)		1.7	2.5	3.5	5.5	7.5
Continuous running duty	Rated output (kW)	1.0	1.5	2.0	3.5	5.0
	Rated torque (Note 7) (N·m [oz·in])	3.18 (450)	4.78 (677)	6.37 (902)	11.1 (1570)	15.9 (2250)
Maximum torque (N·m [oz·in])		7.95 (1130)	11.9 (1690)	15.9 (2250)	27.9 (3950)	39.7 (5620)
Rated speed (r/min)		3000				
Maximum speed (r/min)		4500				
Permissible instantaneous speed (r/min)		5175				
Power rate at continuous rated torque (kW/s)		67.4	120	176	150	211
Rated current (A)		6.1	8.8	14	23	28
Maximum current (A)		18	23	37	58	70
Regenerative braking frequency (times/min) (Note 2)		1090	860	710	174	125
Moment of inertia J ($\times 10^{-4}$ kg·m ²) [J (oz·in ²)]	Standard	1.50 (8.20)	1.90 (10.4)	2.30 (12.6)	8.30 (45.4)	12.0 (65.6)
	With electromagnetic brake	1.85 (10.1)	2.25 (12.3)	2.65 (14.5)	11.8 (64.5)	15.5 (84.7)
Recommended load to motor inertia moment ratio		Maximum of 5 times the servo motor's inertia moment (Note 3)				
Speed/position detector		18-bit encoder (resolution: 262144 p/rev)				
Attachments		Oil seal				
Insulation class		Class F				
Structure		Totally enclosed non ventilated (IP rating: IP65) (Note 4)				
Environment (Note 6)	Ambient temperature	0 to 40°C (32 to 104°F) (non freezing), storage: -15 to 70°C (5 to 158°F) (non freezing)				
	Ambient humidity	80% RH maximum (non condensing), storage: 90% RH maximum (non condensing)				
	Atmosphere	Indoors (no direct sunlight); no corrosive gas, inflammable gas, oil mist or dust				
	Elevation	1000m or less above sea level				
	Vibration (Note 5)	X: 24.5m/s ² Y: 24.5m/s ²				
Mass (kg [lb])	Standard	3.9 (8.6)	5.0 (11)	6.2 (14)	12 (27)	17 (38)
	With electromagnetic brake	6.0 (14)	7.0 (16)	8.3 (19)	15 (33)	21 (47)

- Notes: 1. The power supply capacity varies depending on the power supply's impedance.
 2. The regenerative braking frequency shows the permissible frequency when the motor, without a load and an optional regeneration unit, decelerates from the rated speed to a stop. When a load is connected; however, the value will be the table value/(m+1), where m=load inertia moment/motor inertia moment. When the operating speed exceeds the rated speed, the regenerative braking frequency is inversely proportional to the square of (operating speed/rated speed). If the operating speed changes frequently or when the regeneration is constant (as with vertical feeds), find the regenerative heating value (W) in operation. Provisions must be made to keep this heating value below the tolerable regenerative power (W). Optimal regenerative resistor varies for each system. Select the most suitable regenerative resistor by using the capacity selection software. Refer to the section "Options ● Optional regeneration unit" in this catalog for details on the tolerable regenerative power (W).
 3. Contact your local sales office if the load to motor inertia moment ratio exceeds the value in the table.
 4. The shaft-through portion is excluded.
 5. The vibration direction is shown in the diagram to the right. The numeric value indicates the maximum value of the component (commonly the bracket in the opposite direction of the motor shaft). Fretting of the bearing occurs easily when the motor stops, so maintain vibration to approximately one-half of the allowable value.
 6. In the environment where the servo motor is exposed to oil mist, oil and/or water, a standard specification servo motor may not be usable. Contact your local sales office for more details.
 7. When unbalanced torque is generated, such as in a vertical lift machine, it is recommended that the unbalanced torque of the machine be kept under 70% of the motor's rated torque.



HC-RP Series Servo Motor Torque Characteristics

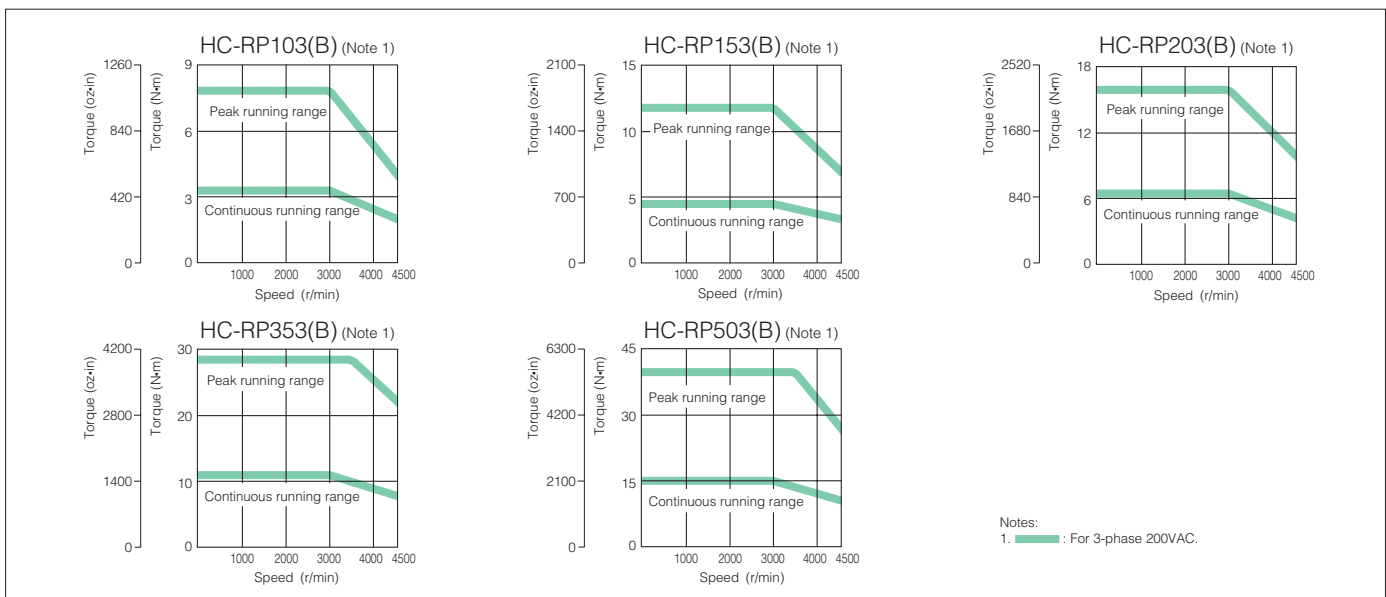



HC-UP Series Servo Motor Specifications

Servo motor series		HC-UP series (Flat type, medium capacity)				
Servo motor model HC-UP		72(B)	152(B)	202(B)	352(B)	502(B)
Compatible servo amplifier model MR-J3-		70A/B(-RJ006)/T	200AN/BN(-RJ006)/TN	350A/B(-RJ006)/T	500A/B(-RJ006)/T	
Power supply capacity (Note 1) (kVA)		1.3	2.5	3.5	5.5	7.5
Continuous running duty	Rated output (kW)	0.75	1.5	2.0	3.5	5.0
	Rated torque (Note 7) (N·m [oz·in])	3.58 (507)	7.16 (1010)	9.55 (1350)	16.7 (2360)	23.9 (3380)
Maximum torque (N·m [oz·in])		10.7 (1520)	21.6 (3060)	28.5 (4040)	50.1 (7090)	71.6 (10100)
Rated speed (r/min)		2000				
Maximum speed (r/min)		3000			2500	
Permissible instantaneous speed (r/min)		3450			2875	
Power rate at continuous rated torque (kW/s)		12.3	23.2	23.9	36.5	49.6
Rated current (A)		5.4	9.7	14	23	28
Maximum current (A)		16	29	42	69	84
Regenerative braking frequency (times/min) (Note 2)		53	124	68	44	31
Moment of inertia J ($\times 10^{-4}$ kg·m ²) [J (oz·in ²)]	Standard	10.4 (56.9)	22.1 (121)	38.2 (209)	76.5 (418)	115 (629)
	With electromagnetic brake	12.5 (68.3)	24.2 (132)	46.8 (256)	85.1 (465)	124 (678)
Recommended load to motor inertia moment ratio		Maximum of 15 times the servo motor's inertia moment (Note 3)				
Speed/position detector		18-bit encoder (resolution: 262144 p/rev)				
Attachments		Oil seal				
Insulation class		Class F				
Structure		Totally enclosed non ventilated (IP rating: IP65) (Note 4)				
Environment (Note 6)	Ambient temperature	0 to 40°C (32 to 104°F) (non freezing), storage: -15 to 70°C (5 to 158°F) (non freezing)				
	Ambient humidity	80% RH maximum (non condensing), storage: 90% RH maximum (non condensing)				
	Atmosphere	Indoors (no direct sunlight); no corrosive gas, inflammable gas, oil mist or dust				
	Elevation	1000m or less above sea level				
	Vibration (Note 5)	X: 24.5m/s ² Y: 24.5m/s ²		X: 24.5m/s ² Y: 49m/s ²		
Mass (kg [lb])	Standard	8.0 (18)	11 (25)	16 (36)	20 (44)	24 (53)
	With electromagnetic brake	10 (22)	13 (29)	22 (49)	26 (58)	30 (67)

Notes: 1. The power supply capacity varies depending on the power supply's impedance.

2. The regenerative braking frequency shows the permissible frequency when the motor, without a load and an optional regeneration unit, decelerates from the rated speed to a stop. When a load is connected; however, the value will be the table value/(m+1), where m=load inertia moment/motor inertia moment. When the operating speed exceeds the rated speed, the regenerative braking frequency is inversely proportional to the square of (operating speed/rated speed). If the operating speed changes frequently or when the regeneration is constant (as with vertical feeds), find the regenerative heating value (W) in operation. Provisions must be made to keep this heating value below the tolerable regenerative power (W). Optimal regenerative resistor varies for each system. Select the most suitable regenerative resistor by using the capacity selection software. Refer to the section "Options ● Optional regeneration unit" in this catalog for details on the tolerable regenerative power (W).

3. Contact your local sales office if the load to motor inertia moment ratio exceeds the value in the table.

4. The shaft-through portion is excluded.

5. The vibration direction is shown in the diagram to the right. The numeric value indicates the maximum value of the component (commonly the bracket in the opposite direction of the motor shaft). Fretting of the bearing occurs easily when the motor stops, so maintain vibration to approximately one-half of the allowable value.

6. In the environment where the servo motor is exposed to oil mist, oil and/or water, a standard specification servo motor may not be usable. Contact your local sales office for more details.

7. When unbalanced torque is generated, such as in a vertical lift machine, it is recommended that the unbalanced torque of the machine be kept under 70% of the motor's rated torque.



HC-UP Series Servo Motor Torque Characteristics

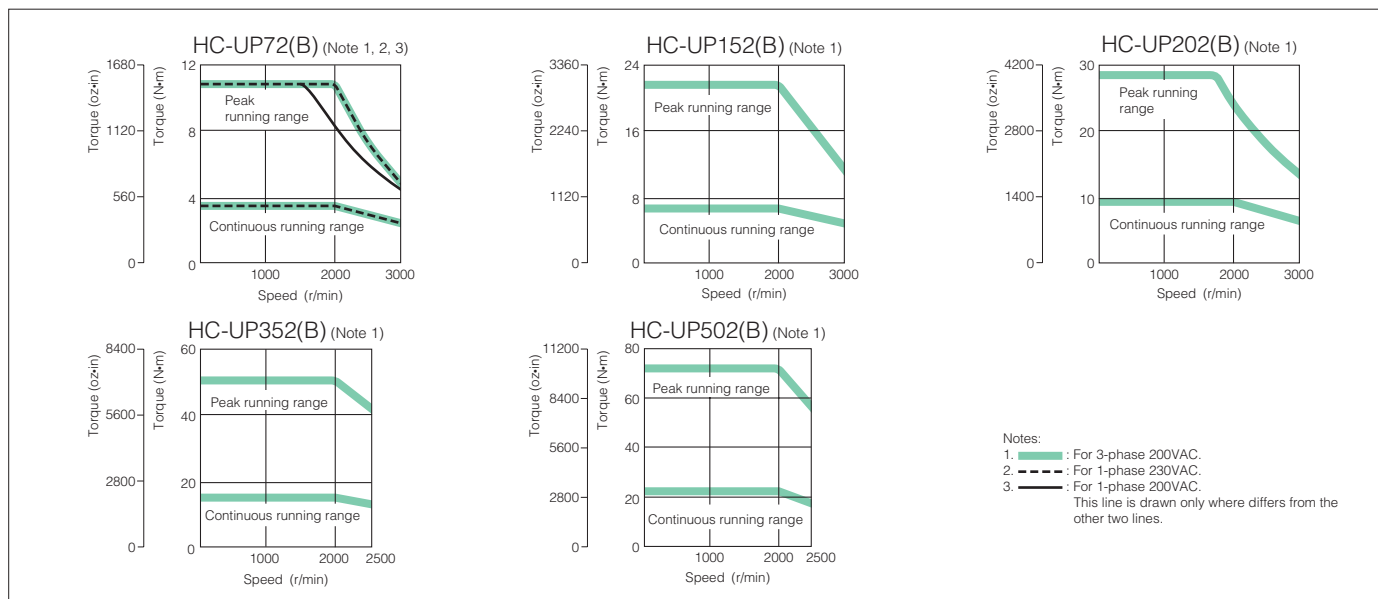

Model designation
Servo motors
Servo amplifiers
Options
Peripheral equipment
MR-J3-B Safety series
MR-J3W series
Servo support software
Cautions
Warranty
Global FA centers

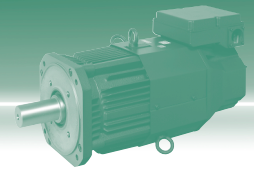

HA-LP 1000r/min Series Servo Motor Specifications (200VAC Class)

Servo motor series		HA-LP 1000r/min series (Low inertia, medium/large capacity)							
Servo motor model HA-LP		601(B)	801(B)	12K1(B)	15K1	20K1	25K1	30K1	37K1
Compatible servo amplifier model MR-J3-		700A/B (-RJ006)/T	11KA/B(-RJ006)/T		15KA/B (-RJ006)/T	22KA/B(-RJ006)/T		DU30KA/B	DU37KA/B
Power supply capacity (Note 1) (kVA)		8.6	12	18	22	30	38	48	59
Continuous running duty	Rated output (kW)	6.0	8.0	12	15	20	25	30	37
	Rated torque (Note 8)(N·m [oz·in])	57.3 (8110)	76.4 (10800)	115 (16300)	143 (20200)	191 (27000)	239 (33800)	286 (40500)	353 (50000)
Maximum torque (N·m [oz·in])		172 (24400)	229 (32400)	344 (48700)	415 (58800)	477 (67500)	597 (84500)	716 (101000)	883 (125000)
Rated speed (r/min)		1000							
Maximum speed (r/min)		1200							
Permissible instantaneous speed (r/min)		1380							
Power rate at continuous rated torque (kW/s)		313	265	445	373	561	528	626	668
Rated current (A)		34	42	61	83	118	118	154	188
Maximum current (A)		102	126	183	249	295	295	385	470
Regenerative braking frequency (times/min) (Note 2)		158	354 (Note 6)	264 (Note 6)	230 (Note 6)	195 (Note 6)	117 (Note 6)	-	-
Moment of inertia J ($\times 10^{-4} \text{kg}\cdot\text{m}^2$) [J (oz·in ²)]	Standard	105 (574)	220 (1200)	295 (1610)	550 (3010)	650 (3550)	1080 (5900)	1310 (7160)	1870 (10200)
	With electromagnetic brake	113 (618)	293 (1600)	369 (2020)	-	-	-	-	-
Recommended load to motor inertia moment ratio		Maximum of 10 times the servo motor's inertia moment (Note 3)							
Speed/position detector		18-bit encoder (resolution: 262144 p/rev)							
Attachments		Oil seal							
Insulation class		Class F							
Structure		Totally enclosed ventilated (IP rating: IP44) (Note 4)							
Environment (Note 7)	Ambient temperature	0 to 40°C (32 to 104°F) (non freezing), storage: -15 to 70°C (5 to 158°F) (non freezing)							
	Ambient humidity	80% RH maximum (non condensing), storage: 90% RH maximum (non condensing)							
	Atmosphere	Indoors (no direct sunlight); no corrosive gas, inflammable gas, oil mist or dust							
	Elevation	1000m or less above sea level							
	Vibration (Note 5)	X: 11.7m/s ² Y: 29.4m/s ²				X: 9.8m/s ² Y: 9.8m/s ²			
Mass (kg [lb])	Standard	55 (125)	95 (210)	115 (255)	160 (355)	180 (400)	230 (510)	250 (555)	335 (740)
	With electromagnetic brake	70 (155)	130 (290)	150 (335)	-	-	-	-	-
Cooling fan	Power	Voltage, frequency	1-phase 200 to 220VAC/50Hz 1-phase 200 to 230VAC/60Hz		3-phase 200 to 230VAC 50/60Hz				
		Input (W)	42 (50Hz) / 54 (60Hz)		62 (50Hz) / 76 (60Hz)		65 (50Hz) / 85 (60Hz)		120 (50Hz) / 175 (60Hz)
	Rated current (A)	0.21 (50Hz) / 0.25 (60Hz)		0.18 (50Hz) / 0.17 (60Hz)		0.20 (50Hz) / 0.22 (60Hz)		0.65 (50Hz) / 0.80 (60Hz)	

Notes: 1. The power supply capacity varies depending on the power supply's impedance.

2. The regenerative braking frequency shows the permissible frequency when the motor, without a load and an optional regeneration unit, decelerates from the rated speed to a stop. When a load is connected, however, the value will be the table value/(m+1), where m=load inertia moment/motor inertia moment. When the operating speed exceeds the rated speed, the regenerative braking frequency is inversely proportional to the square of (operating speed/rated speed). If the operating speed changes frequently or when the regeneration is constant (as with vertical feeds), find the regenerative heating value (W) in operation. Provisions must be made to keep this heating value below the tolerable regenerative power (W). Optimal regenerative resistor varies for each system. Select the most suitable regenerative resistor by using the capacity selection software. Refer to the section "Options ● Optional regeneration unit" in this catalog for details on the tolerable regenerative power (W).

HA-LP 1000r/min Series Servo Motor Torque Characteristics (200VAC Class)

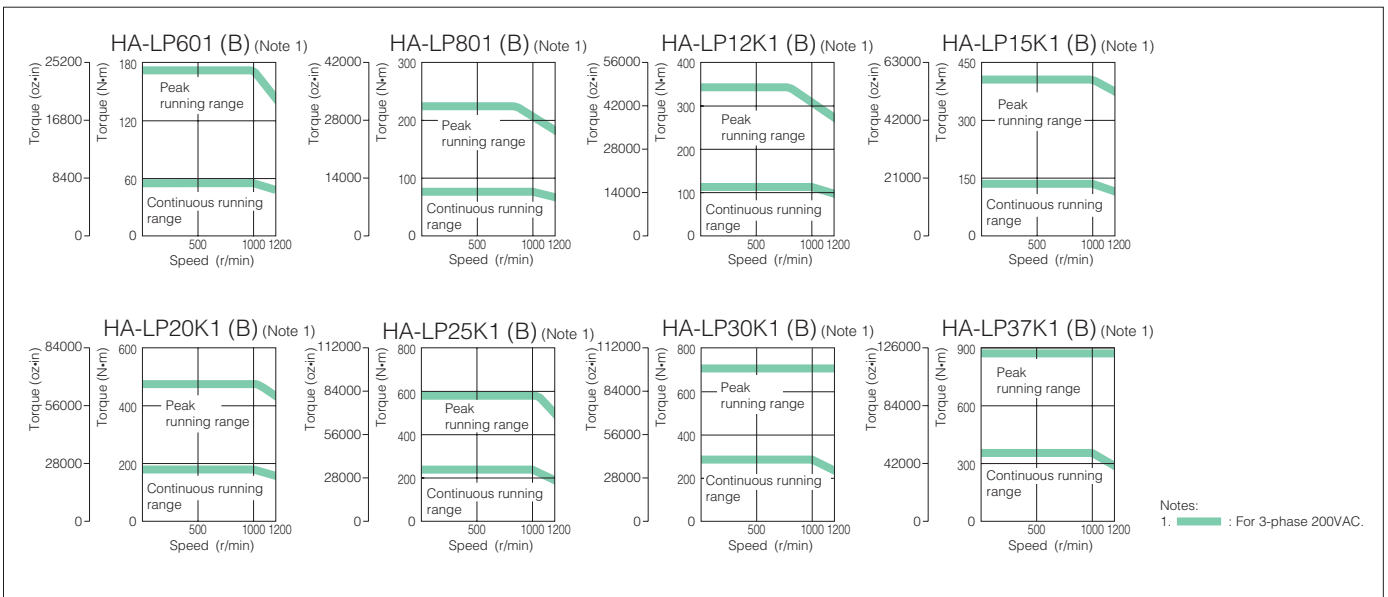

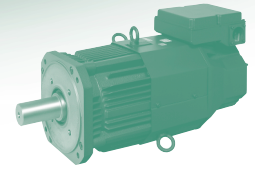

HA-LP 1000r/min Series Servo Motor Specifications (400VAC Class)

HA-LP 1000r/min series (Low inertia, medium/large capacity)							
6014(B)	8014(B)	12K14(B)	15K14	20K14	25K14	30K14	37K14
700A4/B4 (-RJ006)/T4	11KA4/B4(-RJ006)/T4		15KA4/B4 (-RJ006)/T4	22KA4/B4 (-RJ006)/T4	DU30KA4/B4		DU37KA4/B4
8.6	12	18	22	30	38	48	59
6.0	8.0	12	15	20	25	30	37
57.3 (8110)	76.4 (10800)	115 (16300)	143 (20200)	191 (27000)	239 (33800)	286 (40500)	353 (50000)
172 (24400)	229 (32400)	344 (48700)	415 (58800)	477 (67500)	597 (84500)	716 (101000)	883 (125000)
1000							
1200							
1380							
313	265	445	373	561	528	626	668
17	20	30	40	55	70	77	95
51	60	90	120	138	175	193	238
169	354 (Note 6)	264 (Note 6)	230 (Note 6)	195 (Note 6)	-	-	-
105 (574)	220 (1200)	295 (1610)	550 (3010)	650 (3550)	1080 (5900)	1310 (7160)	1870 (10200)
113 (618)	293 (1600)	369 (2020)	-	-	-	-	-
Maximum of 10 times the servo motor's inertia moment (Note 3)							
18-bit encoder (resolution: 262144 p/rev)							
Oil seal							
Class F							
Totally enclosed ventilated (IP rating: IP44) (Note 4)							
0 to 40°C (32 to 104°F) (non freezing), storage: -15 to 70°C (5 to 158°F) (non freezing)							
80% RH maximum (non condensing), storage: 90% RH maximum (non condensing)							
Indoors (no direct sunlight); no corrosive gas, inflammable gas, oil mist or dust							
1000m or less above sea level							
X: 11.7m/s ² Y: 29.4m/s ²				X: 9.8m/s ² Y: 9.8m/s ²			
55 (125)	95 (210)	115 (255)	160 (355)	180 (400)	230 (510)	250 (555)	335 (740)
70 (155)	130 (290)	150 (335)	-	-	-	-	-
1-phase 200 to 220VAC/50Hz 1-phase 200 to 230VAC/60Hz	3-phase 380 to 440VAC/50Hz 3-phase 380 to 480VAC/60Hz		3-phase 380 to 460VAC/50Hz 3-phase 380 to 480VAC/60Hz				
42 (50Hz) / 54 (60Hz)	62 (50Hz) / 76 (60Hz)		65 (50Hz) / 85 (60Hz)		110 (50Hz) / 150 (60Hz)		
0.21 (50Hz) / 0.25 (60Hz)	0.14 (50Hz) / 0.11 (60Hz)		0.12 (50Hz) / 0.14 (60Hz)		0.20 (50Hz) / 0.22 (60Hz)		

- Contact your local sales office if the load to motor inertia moment ratio exceeds the value in the table.
- The shaft-through portion is excluded.
- The vibration direction is shown in the diagram to the right. The numeric value indicates the maximum value of the component (commonly the bracket in the opposite direction of the motor shaft). Fretting of the bearing occurs easily when the motor stops, so maintain vibration to approximately one-half of the allowable value.
- The value is applicable when the external regenerative resistors, GRZG400-□Ω (standard accessory) are used with cooling fans (2 units of 92 X 92mm, minimum air flow: 1.0m³/min). Note that change in parameter No. PA02 is required.
- In the environment where the servo motor is exposed to oil mist, oil and/or water, a standard specification servo motor may not be usable. Contact your local sales office for more details.
- When unbalanced torque is generated, such as in a vertical lift machine, it is recommended that the unbalanced torque of the machine be kept under 70% of the motor's rated torque.

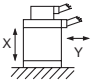

HA-LP 1000r/min Series Servo Motor Torque Characteristics (400VAC Class)

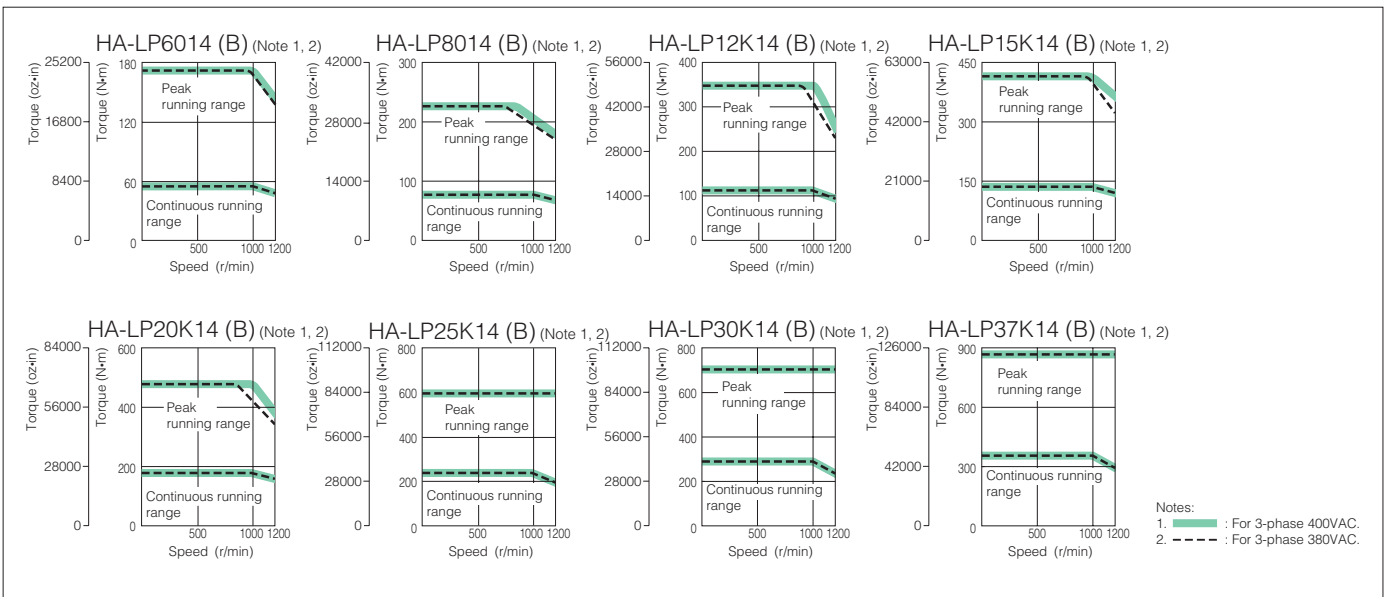

Model designation
 Servo motors
 Servo amplifiers
 Options
 Peripheral equipment
 MR-J3-B Safety series
 MR-J3W series
 Servo support software
 Cautions
 Warranty
 Global FA centers

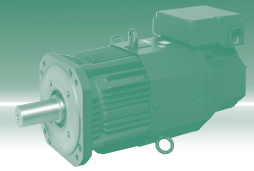

HA-LP 1500r/min Series Servo Motor Specifications (200VAC Class)

Servo motor series		HA-LP 1500r/min series (Low inertia, medium/large capacity)					
Servo motor model HA-LP		701M(B)	11K1M(B)	15K1M(B)	22K1M	30K1M	37K1M
Compatible servo amplifier model MR-J3-		700A/B(-RJ006)/T	11KA/B(-RJ006)/T	15KA/B(-RJ006)/T	22KA/B(-RJ006)/T	DU30KA/B	DU37KA/B
Power supply capacity (Note 1) (kVA)		10	16	22	33	48	59
Continuous running duty	Rated output (kW)	7.0	11	15	22	30	37
	Rated torque (Note 8) (N·m [oz·in])	44.6 (6320)	70.0 (9910)	95.5 (13500)	140 (19800)	191 (27000)	236 (33400)
Maximum torque (N·m [oz·in])		134 (19000)	210 (29700)	286 (40500)	350 (49600)	477 (67500)	589 (83400)
Rated speed (r/min)		1500					
Maximum speed (r/min)		2000					
Permissible instantaneous speed (r/min)		2300					
Power rate at continuous rated torque (kW/s)		189	223	309	357	561	514
Rated current (A)		37	65	87	126	174	202
Maximum current (A)		111	195	261	315	435	505
Regenerative braking frequency (times/min) (Note 2)		70	158 (Note 6)	191 (Note 6)	102 (Note 6)	—	—
Moment of inertia J ($\times 10^{-4}$ kg·m ²) [J (oz·in ²)]	Standard	105 (574)	220 (1200)	295 (1610)	550 (3010)	650 (3550)	1080 (5900)
	With electromagnetic brake	113 (618)	293 (1600)	369 (2020)	—	—	—
Recommended load to motor inertia moment ratio		Maximum of 10 times the servo motor's inertia moment (Note 3)					
Speed/position detector		18-bit encoder (resolution: 262144 p/rev)					
Attachments		Oil seal					
Insulation class		Class F					
Structure		Totally enclosed ventilated (IP rating: IP44) (Note 4)					
Environment (Note 7)	Ambient temperature	0 to 40°C (32 to 104°F) (non freezing), storage: -15 to 70°C (5 to 158°F) (non freezing)					
	Ambient humidity	80% RH maximum (non condensing), storage: 90% RH maximum (non condensing)					
	Atmosphere	Indoors (no direct sunlight); no corrosive gas, inflammable gas, oil mist or dust					
	Elevation	1000m or less above sea level					
	Vibration (Note 5)	X: 11.7m/s ² Y: 29.4m/s ²			X: 9.8m/s ² Y: 9.8m/s ²		
Mass (kg [lb])	Standard	55 (125)	95 (210)	115 (255)	160 (355)	180 (400)	230 (510)
	With electromagnetic brake	70 (155)	130 (290)	150 (335)	—	—	—
Cooling fan	Power	Voltage, frequency	1-phase 200 to 220VAC/50Hz 1-phase 200 to 230VAC/60Hz		3-phase 200 to 230VAC 50/60Hz		
		Input (W)	42 (50Hz) / 54 (60Hz)		62 (50Hz) / 76 (60Hz)		65 (50Hz) / 85 (60Hz)
	Rated current (A)	0.21 (50Hz) / 0.25 (60Hz)		0.18 (50Hz) / 0.17 (60Hz)		0.20 (50Hz) / 0.22 (60Hz)	

Notes: 1. The power supply capacity varies depending on the power supply's impedance.

2. The regenerative braking frequency shows the permissible frequency when the motor, without a load and an optional regeneration unit, decelerates from the rated speed to a stop. When a load is connected; however, the value will be the table value/(m+1), where m=load inertia moment/motor inertia moment. When the operating speed exceeds the rated speed, the regenerative braking frequency is inversely proportional to the square of (operating speed/rated speed). If the operating speed changes frequently or when the regeneration is constant (as with vertical feeds), find the regenerative heating value (W) in operation. Provisions must be made to keep this heating value below the tolerable regenerative power (W). Optimal regenerative resistor varies for each system. Select the most suitable regenerative resistor by using the capacity selection software. Refer to the section "Options ● Optional regeneration unit" in this catalog for details on the tolerable regenerative power (W).

HA-LP 1500r/min Series Servo Motor Torque Characteristics (200VAC Class)

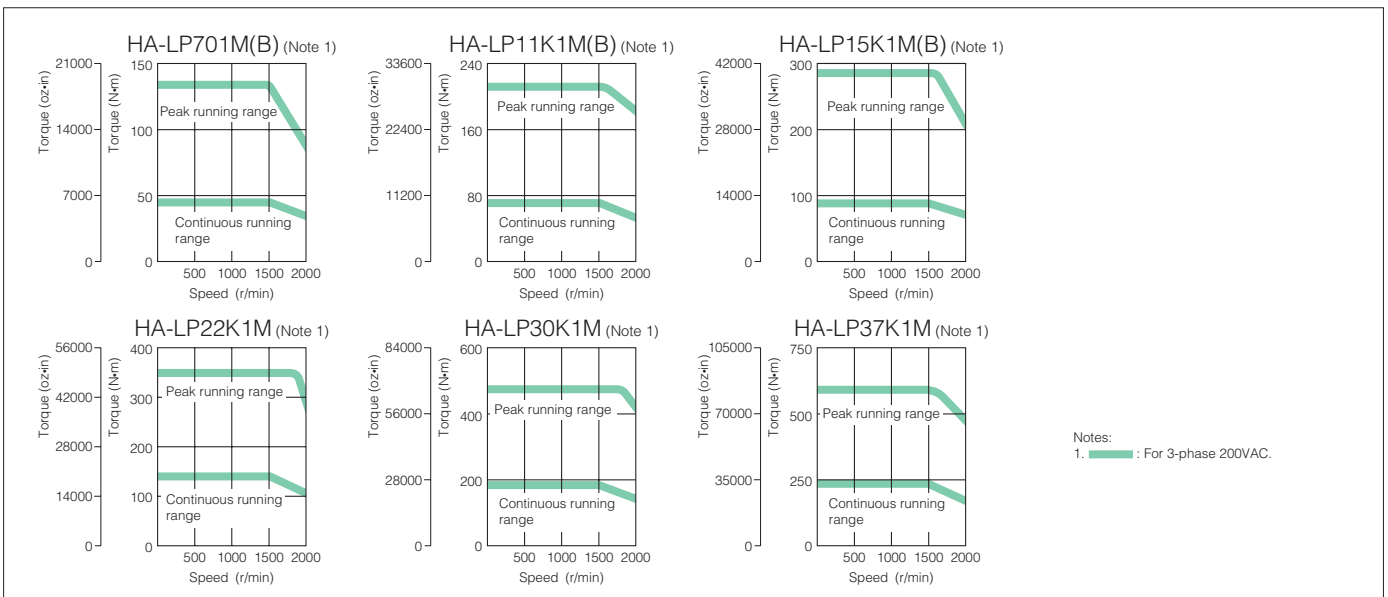

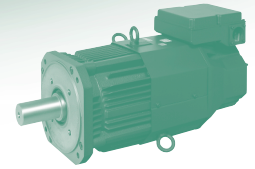

HA-LP 1500r/min Series Servo Motor Specifications (400VAC Class)

HA-LP 1500r/min series (Low inertia, medium/large capacity)							
701M4(B)	11K1M4(B)	15K1M4(B)	22K1M4	30K1M4	37K1M4	45K1M4	50K1M4
700A4/B4(-RJ006)/T4	11KA4/B4(-RJ006)/T4	15KA4/B4(-RJ006)/T4	22KA4/B4(-RJ006)/T4	DU30KA4/B4	DU37KA4/B4	DU45KA4/B4	DU55KA4/B4
10	16	22	33	48	59	71	80
7.0	11	15	22	30	37	45	50
44.6 (6320)	70.0 (9910)	95.5 (13500)	140 (19800)	191 (27000)	236 (33400)	286 (40500)	318 (45000)
134 (19000)	210 (29700)	286 (40500)	350 (49600)	477 (67500)	589 (83400)	716 (101000)	796 (113000)
1500							
2000							
2300							
189	223	309	357	561	514	626	542
18	31	41	63	87	101	128	143
54	93	123	158	218	253	320	358
75	158 (Note 6)	191 (Note 6)	102 (Note 6)	—	—	—	—
105 (574)	220 (1200)	295 (1610)	550 (3010)	650 (3550)	1080 (5900)	1310 (7160)	1870 (10200)
113 (618)	293 (1600)	369 (2020)	—	—	—	—	—
Maximum of 10 times the servo motor's inertia moment (Note 3)							
18-bit encoder (resolution: 262144 p/rev)							
Oil seal							
Class F							
Totally enclosed ventilated (IP rating: IP44) (Note 4)							
0 to 40°C (32 to 104°F) (non freezing), storage: -15 to 70°C (5 to 158°F) (non freezing)							
80% RH maximum (non condensing), storage: 90% RH maximum (non condensing)							
Indoors (no direct sunlight); no corrosive gas, inflammable gas, oil mist or dust							
1000m or less above sea level							
X: 11.7m/s ² Y: 29.4m/s ²				X: 9.8m/s ² Y: 9.8m/s ²			
55 (125)	95 (210)	115 (255)	160 (355)	180 (400)	230 (510)	250 (555)	335 (740)
70 (155)	130 (290)	150 (335)	—	—	—	—	—
1-phase 200 to 220VAC/50Hz 1-phase 200 to 230VAC/60Hz	3-phase 380 to 440VAC/50Hz 3-phase 380 to 480VAC/60Hz		3-phase 380 to 460VAC/50Hz 3-phase 380 to 480VAC/60Hz				
42 (50Hz) / 54 (60Hz)	62 (50Hz) / 76 (60Hz)		65 (50Hz) / 85 (60Hz)		110 (50Hz) / 150 (60Hz)		
0.21 (50Hz) / 0.25 (60Hz)	0.14 (50Hz) / 0.11 (60Hz)		0.12 (50Hz) / 0.14 (60Hz)		0.20 (50Hz) / 0.22 (60Hz)		

3. Contact your local sales office if the load to motor inertia moment ratio exceeds the value in the table.

4. The shaft-through portion is excluded.

5. The vibration direction is shown in the diagram to the right. The numeric value indicates the maximum value of the component (commonly the bracket in the opposite direction of the motor shaft). Fretting of the bearing occurs easily when the motor stops, so maintain vibration to approximately one-half of the allowable value.

6. The value is applicable when the external regenerative resistors, GRZG400-□□ (standard accessory) are used with cooling fans (2 units of 92 X 92mm, minimum air flow: 1.0m³/min). Note that change in parameter No. PA02 is required.

7. In the environment where the servo motor is exposed to oil mist, oil and/or water, a standard specification servo motor may not be usable. Contact your local sales office for more details.

8. When unbalanced torque is generated, such as in a vertical lift machine, it is recommended that the unbalanced torque of the machine be kept under 70% of the motor's rated torque.

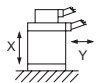

HA-LP 1500r/min Series Servo Motor Torque Characteristics (400VAC Class)

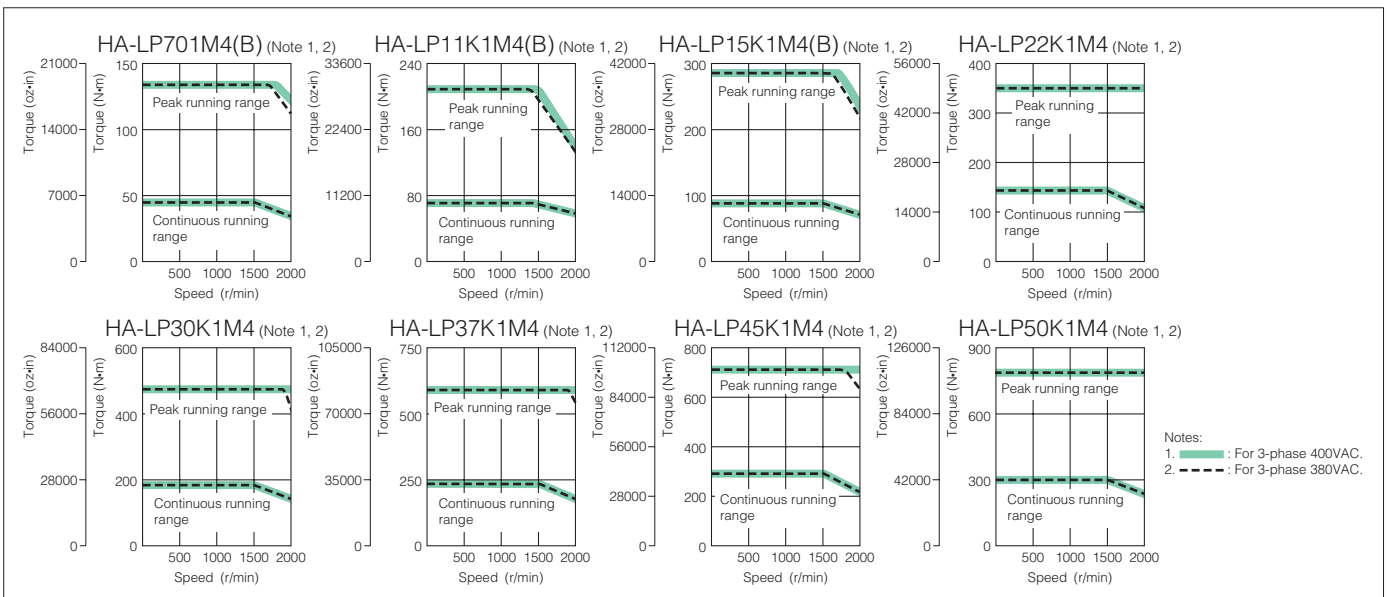

Model designation

Servo motors

Servo amplifiers

Options

Peripheral equipment

MR-J3-BSafety

MR-J3W series

Servo support software

Cautions

Warranty

Global FA centers

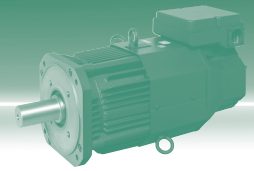

HA-LP 2000r/min Series Servo Motor Specifications (200VAC Class)

Servo motor series		HA-LP 2000r/min series (Low inertia, medium/large capacity)						
Servo motor model HA-LP		502	702	11K2(B)	15K2(B)	22K2(B)	30K2	37K2
Compatible servo amplifier model MR-J3-		500A/B(-RJ006)/T	700A/B(-RJ006)/T	11KA/B(-RJ006)/T	15KA/B(-RJ006)/T	22KA/B(-RJ006)/T	DU30KA/B	DU37KA/B
Power supply capacity (Note 1) (kVA)		7.5	10	16	22	33	48	59
Continuous running duty	Rated output (kW)	5.0	7.0	11	15	22	30	37
	Rated torque (Note 8) (N·m [oz·in])	23.9 (3380)	33.4 (4730)	52.5 (7430)	71.6 (10100)	105 (14900)	143 (20200)	177 (25100)
Maximum torque (N·m [oz·in])		71.6 (10100)	100 (14200)	158 (22400)	215 (30400)	263 (37200)	358 (50700)	442 (62600)
Rated speed (r/min)		2000						
Maximum speed (r/min)		2000						
Permissible instantaneous speed (r/min)		2300						
Power rate at continuous rated torque (kW/s)		77.2	118	263	233	374	373	480
Rated current (A)		25	34	63	77	112	166	204
Maximum current (A)		75	102	189	231	280	415	510
Regenerative braking frequency (times/min) (Note 2)		50	50	186 (Note 6)	144 (Note 6)	107 (Note 6)	—	—
Moment of inertia J ($\times 10^{-4}$ kg·m ²) [J (oz·in ²)]	Standard	74.0 (405)	94.2 (515)	105 (574)	220 (1200)	295 (1610)	550 (3010)	650 (3550)
	With electromagnetic brake	—	—	113 (618)	293 (1600)	369 (2020)	—	—
Recommended load to motor inertia moment ratio		Maximum of 10 times the servo motor's inertia moment (Note 3)						
Speed/position detector		18-bit encoder (resolution: 262144 p/rev)						
Attachments		Oil seal						
Insulation class		Class F						
Structure		Totally enclosed non ventilated (IP rating: IP65) (Note 4)			Totally enclosed ventilated (IP rating: IP44) (Note 4)			
Environment (Note 7)	Ambient temperature	0 to 40°C (32 to 104°F) (non freezing), storage: -15 to 70°C (5 to 158°F) (non freezing)						
	Ambient humidity	80% RH maximum (non condensing), storage: 90% RH maximum (non condensing)						
	Atmosphere	Indoors (no direct sunlight); no corrosive gas, inflammable gas, oil mist or dust						
	Elevation	1000m or less above sea level						
	Vibration (Note 5)	X: 11.7m/s ² Y: 29.4m/s ²					X: 9.8m/s ² Y: 9.8m/s ²	
Mass (kg [lb])	Standard	28 (62)	35 (78)	55 (125)	95 (210)	115 (255)	160 (355)	180 (400)
	With electromagnetic brake	—	—	70 (155)	130 (290)	150 (335)	—	—
Cooling fan	Power	Voltage, frequency	—		1-phase 200 to 220VAC/50Hz 1-phase 200 to 230VAC/60Hz 3-phase 200 to 230VAC 50/60Hz			
		Input (W)	—		42 (50Hz) / 54 (60Hz)		62 (50Hz) / 76 (60Hz)	
	Rated current (A)	—		0.21 (50Hz) / 0.25 (60Hz)		0.18 (50Hz) / 0.17 (60Hz)		0.20 (50Hz) / 0.22 (60Hz)

Notes: 1. The power supply capacity varies depending on the power supply's impedance.

2. The regenerative braking frequency shows the permissible frequency when the motor, without a load and an optional regeneration unit, decelerates from the rated speed to a stop. When a load is connected; however, the value will be the table value/(m+1), where m=load inertia moment/motor inertia moment. When the operating speed exceeds the rated speed, the regenerative braking frequency is inversely proportional to the square of (operating speed/rated speed). If the operating speed changes frequently or when the regeneration is constant (as with vertical feeds), find the regenerative heating value (W) in operation. Provisions must be made to keep this heating value below the tolerable regenerative power (W). Optimal regenerative resistor varies for each system. Select the most suitable regenerative resistor by using the capacity selection software. Refer to the section "Options ● Optional regeneration unit" in this catalog for details on the tolerable regenerative power (W).

HA-LP 2000r/min Series Servo Motor Torque Characteristics (200VAC Class)

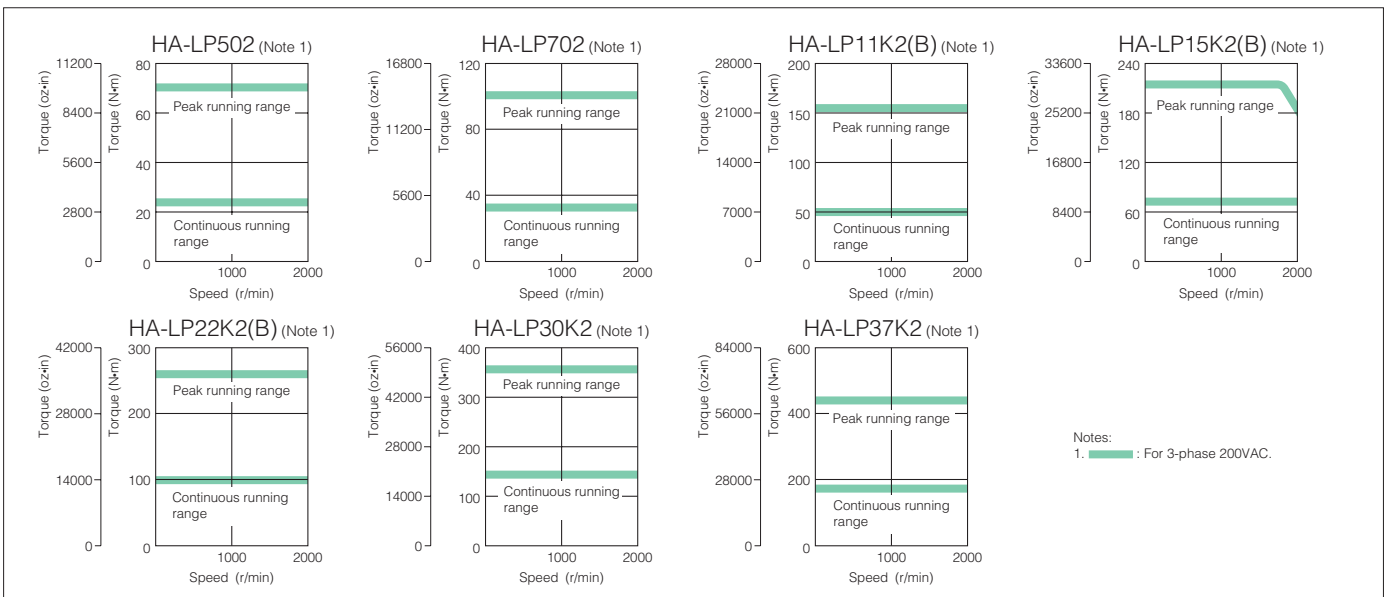

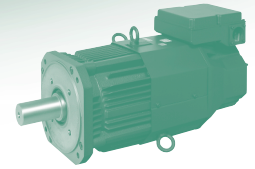

HA-LP 2000r/min Series Servo Motor Specifications (400VAC Class)

HA-LP 2000r/min series (Low inertia, medium/large capacity)							
11K24(B)	15K24(B)	22K24(B)	30K24	37K24	45K24	55K24	
11KA4/B4(-RJ006)/T4	15KA4/B4(-RJ006)/T4	22KA4/B4(-RJ006)/T4	DU30KA4/B4	DU37KA4/B4	DU45KA4/B4	DU55KA4/B4	
16	22	33	48	59	71	87	
11	15	22	30	37	45	55	
52.5 (7430)	71.6 (10100)	105 (14900)	143 (20200)	177 (25100)	215 (30400)	263 (37200)	
158 (22400)	215 (30400)	263 (37200)	358 (50700)	442 (62600)	537 (76000)	657 (93000)	
2000							
2000							
2300							
263	233	374	373	480	427	526	
32	40	57	83	102	131	143	
96	120	143	208	255	328	358	
186 (Note 6)	144 (Note 6)	107 (Note 6)	—	—	—	—	
105 (574)	220 (1200)	295 (1610)	550 (3010)	650 (3550)	1080 (5900)	1310 (7160)	
113 (618)	293 (1600)	369 (2020)	—	—	—	—	
Maximum of 10 times the servo motor's inertia moment (Note 3)							
18-bit encoder (resolution: 262144 p/rev)							
Oil seal							
Class F							
Totally enclosed ventilated (IP rating: IP44) (Note 4)							
0 to 40°C (32 to 104°F) (non freezing), storage: -15 to 70°C (5 to 158°F) (non freezing)							
80% RH maximum (non condensing), storage: 90% RH maximum (non condensing)							
Indoors (no direct sunlight); no corrosive gas, inflammable gas, oil mist or dust							
1000m or less above sea level							
X: 11.7m/s ² Y: 29.4m/s ²				X: 9.8m/s ² Y: 9.8m/s ²			
55 (125)	95 (210)	115 (255)	160 (355)	180 (400)	230 (510)	250 (555)	
70 (155)	130 (290)	150 (335)	—	—	—	—	
1-phase 200 to 220VAC/50Hz 1-phase 200 to 230VAC/60Hz	3-phase 380 to 440VAC/50Hz 3-phase 380 to 480VAC/60Hz		3-phase 380 to 460VAC/50Hz 3-phase 380 to 480VAC/60Hz				
42 (50Hz) / 54 (60Hz)	62 (50Hz) / 76 (60Hz)		65 (50Hz) / 85 (60Hz)		110 (50Hz) / 150 (60Hz)		
0.21 (50Hz) / 0.25 (60Hz)	0.14 (50Hz) / 0.11 (60Hz)		0.12 (50Hz) / 0.14 (60Hz)		0.20 (50Hz) / 0.22 (60Hz)		

- Contact your local sales office if the load to motor inertia moment ratio exceeds the value in the table.
- The shaft-through portion is excluded.
- The vibration direction is shown in the diagram to the right. The numeric value indicates the maximum value of the component (commonly the bracket in the opposite direction of the motor shaft). Fretting of the bearing occurs easily when the motor stops, so maintain vibration to approximately one-half of the allowable value.
- The value is applicable when the external regenerative resistors, GRZG400-□Ω (standard accessory) are used with cooling fans (2 units of 92 X 92mm, minimum air flow: 1.0m³/min). Note that change in parameter No. PA02 is required.
- In the environment where the servo motor is exposed to oil mist, oil and/or water, a standard specification servo motor may not be usable. Contact your local sales office for more details.
- When unbalanced torque is generated, such as in a vertical lift machine, it is recommended that the unbalanced torque of the machine be kept under 70% of the motor's rated torque.

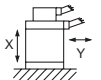

HA-LP 2000r/min Series Servo Motor Torque Characteristics (400VAC Class)

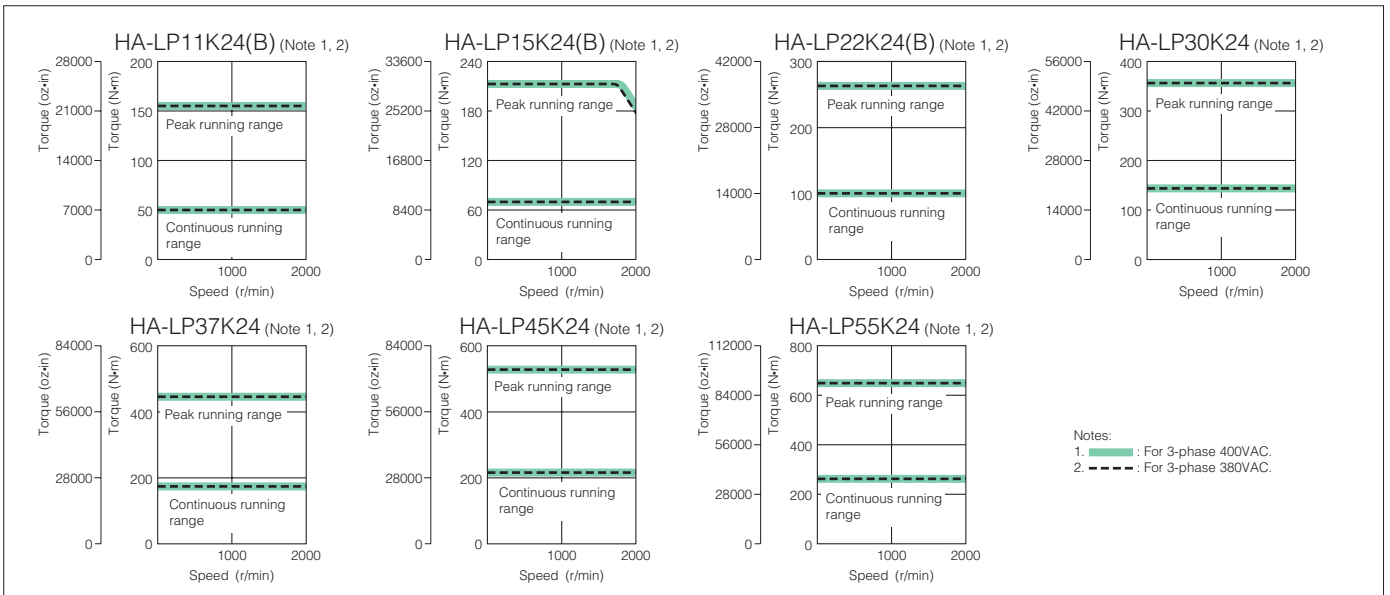

Model designation
 Servo motors
 Servo amplifiers
 Options
 Peripheral equipment
 MR-J3-BSafety series
 MR-J3W series
 Servo support software
 Cautions
 Warranty
 Global FA centers

MELSERVO-J3

Servo Motor Dimensions

(Unit: mm)

- HF-KP053(B), HF-KP13(B)
- HF-MP053(B), HF-MP13(B)

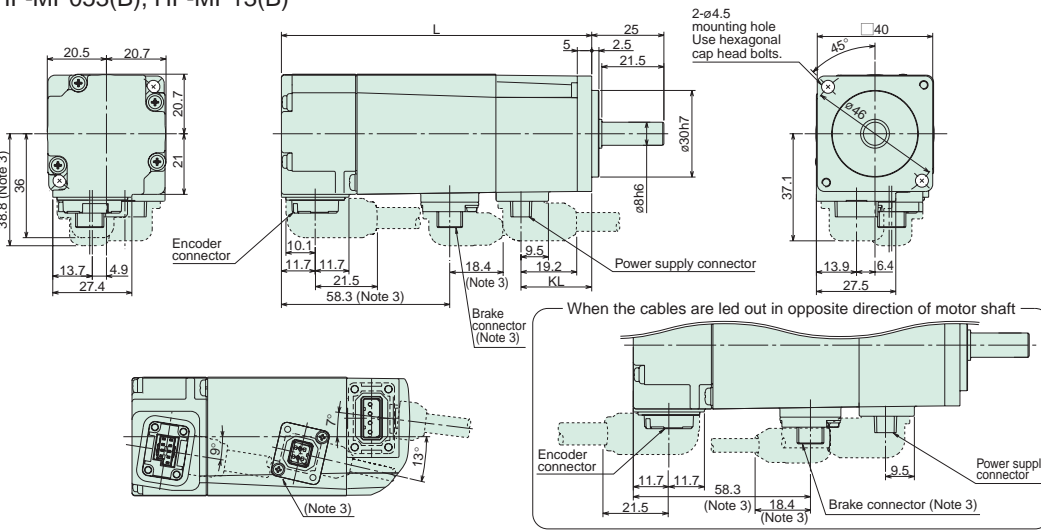

Power supply connector pin assignment

Pin No.	Signal name
1	Earth
2	U
3	V
4	W

Brake connector pin assignment (Note 3)

Pin No.	Signal name
1	B1
2	B2

Model	Variable dimensions	
	L	KL
HF-KP053(B) HF-MP053(B)	66.4 (107.5)	24.5
HF-KP13(B) HF-MP13(B)	82.4 (123.5)	40.5

- HF-KP23(B), HF-KP43(B)
- HF-MP23(B), HF-MP43(B)

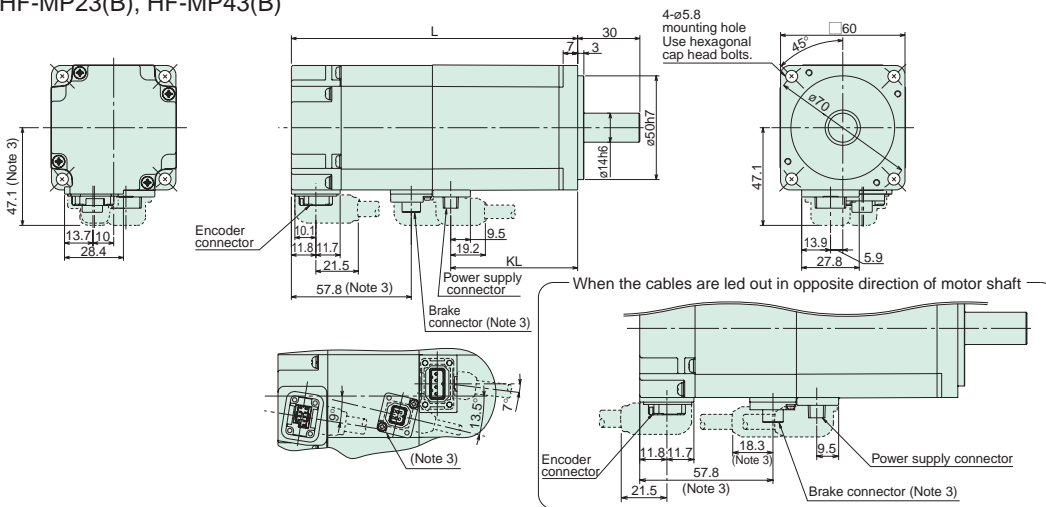

Power supply connector pin assignment

Pin No.	Signal name
1	Earth
2	U
3	V
4	W

Brake connector pin assignment (Note 3)

Pin No.	Signal name
1	B1
2	B2

Model	Variable dimensions	
	L	KL
HF-KP23(B) HF-MP23(B)	76.6 (116.1)	39.3
HF-KP43(B) HF-MP43(B)	98.5 (138)	61.2

- HF-KP73(B)
- HF-MP73(B)

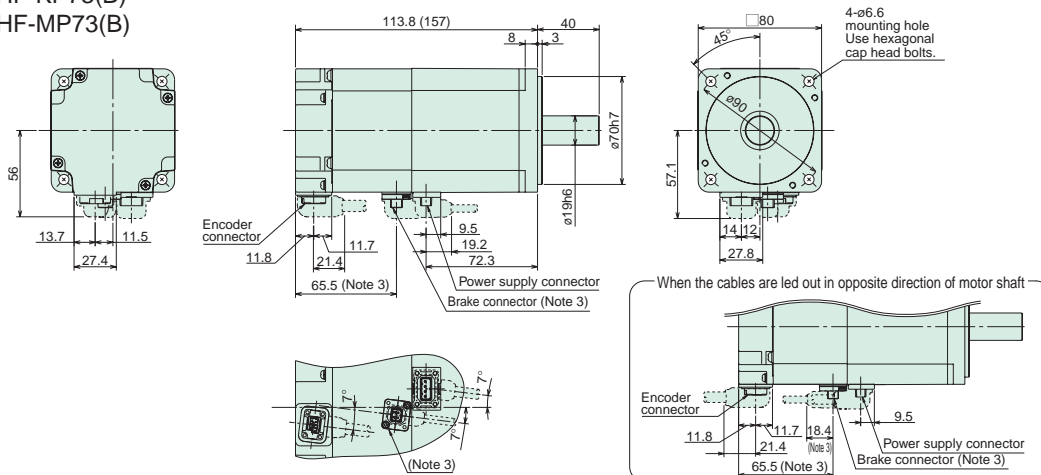

Power supply connector pin assignment

Pin No.	Signal name
1	Earth
2	U
3	V
4	W

Brake connector pin assignment (Note 3)

Pin No.	Signal name
1	B1
2	B2

- Notes:
1. Use a friction coupling to fasten a load.
 2. Dimensions inside () are for the models with an electromagnetic brake.
 3. Only for the models with an electromagnetic brake. The electromagnetic brake terminals (B1, B2) do not have polarity.
 4. For dimensions where there is no tolerance listed, use general tolerance.
 5. Dimensions for motors with an oil seal (HF-KP□J and HF-MP□J) are different from the above. Contact your local sales office for details.

(Unit: mm)

- HF-SP51(B), HF-SP81(B)
- HF-SP52(B), HF-SP102(B), HF-SP152(B)
- HF-SP524(B), HF-SP1024(B), HF-SP1524(B)

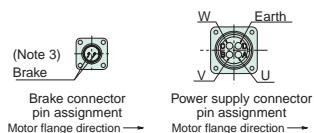
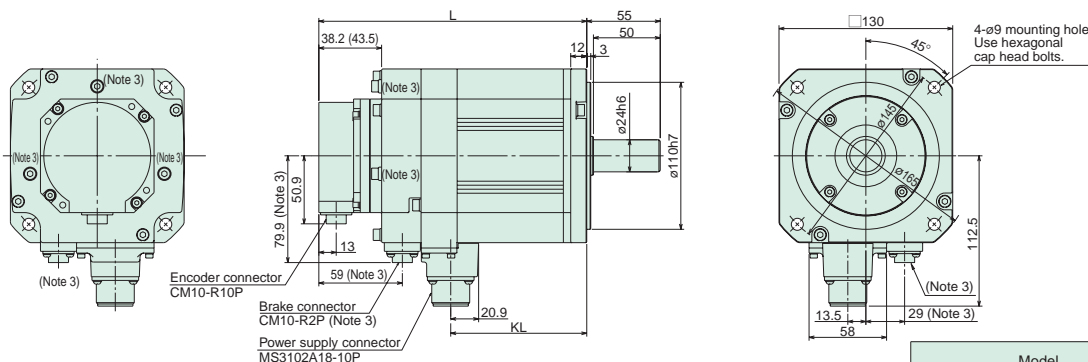

Model		Variable dimensions	
1000r/min	2000r/min	L	KL
—	HF-SP52(4)(B)	118.5 (153)	57.8
HF-SP51(B)	HF-SP102(4)(B)	140.5 (175)	79.8
HF-SP81(B)	HF-SP152(4)(B)	162.5 (197)	101.8

- HF-SP121(B), HF-SP201(B), HF-SP301(B), HF-SP421(B)
- HF-SP202(B), HF-SP352(B), HF-SP502(B), HF-SP702(B)
- HF-SP2024(B), HF-SP3524(B), HF-SP5024(B), HF-SP7024(B)

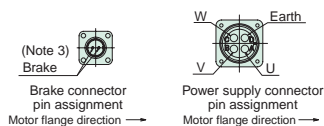
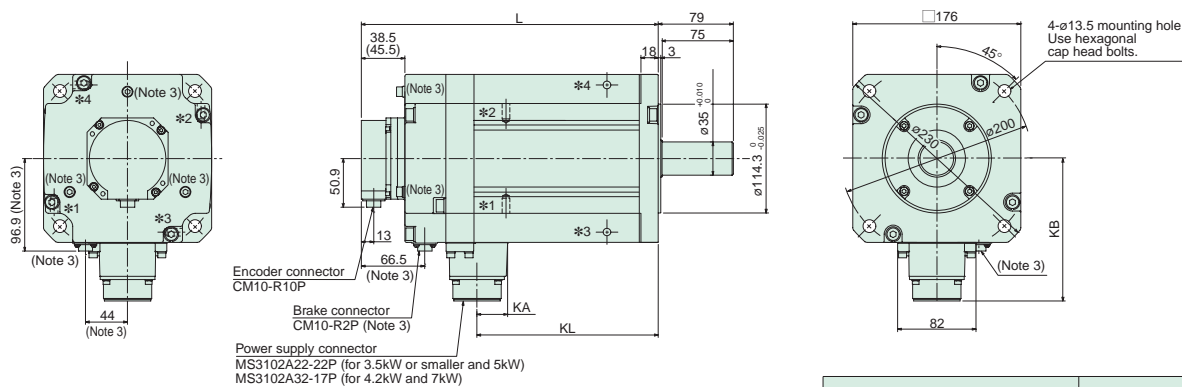

Model		Variable dimensions			
1000r/min	2000r/min	L	KL	KA	KB
HF-SP121(B)	HF-SP202(4)(B)	143.5 (193)	79.8		
HF-SP201(B)	HF-SP352(4)(B)	183.5 (233)	119.8	24.8	140.9
HF-SP301(B)	HF-SP502(4)(B)	203.5 (253)	139.8		
HF-SP421(B)	HF-SP702(4)(B)	263.5 (313)	191.8	32	149.1

- *1, *2, *3 and *4 are screw holes for eyebolt.
- For HF-SP201(B), HF-SP301(B), HF-SP352(4)(B), HF-SP502(4)(B): *3, *4
- For HF-SP421(B), HF-SP702(4)(B): *1, *2, *3, *4

Notes: 1. Use a friction coupling to fasten a load.
 2. Dimensions inside () are for the models with an electromagnetic brake.
 3. Only for the models with an electromagnetic brake. The electromagnetic brake terminals do not have polarity.
 4. For dimensions where there is no tolerance listed, use general tolerance.

Model designation

Servo motors

Servo amplifiers

Options

Peripheral equipment

MR-J3-BSafety

MR-J3W series

Servo support software

Cautions

Warranty

Global FA centers

MELSERVO-J3

Servo Motor Dimensions

(Unit: mm)

- HF-JP53(B), HF-JP73(B), HF-JP103(B), HF-JP153(B), HF-JP203(B)
- HF-JP534(B), HF-JP734(B), HF-JP1034(B), HF-JP1534(B), HF-JP2034(B)

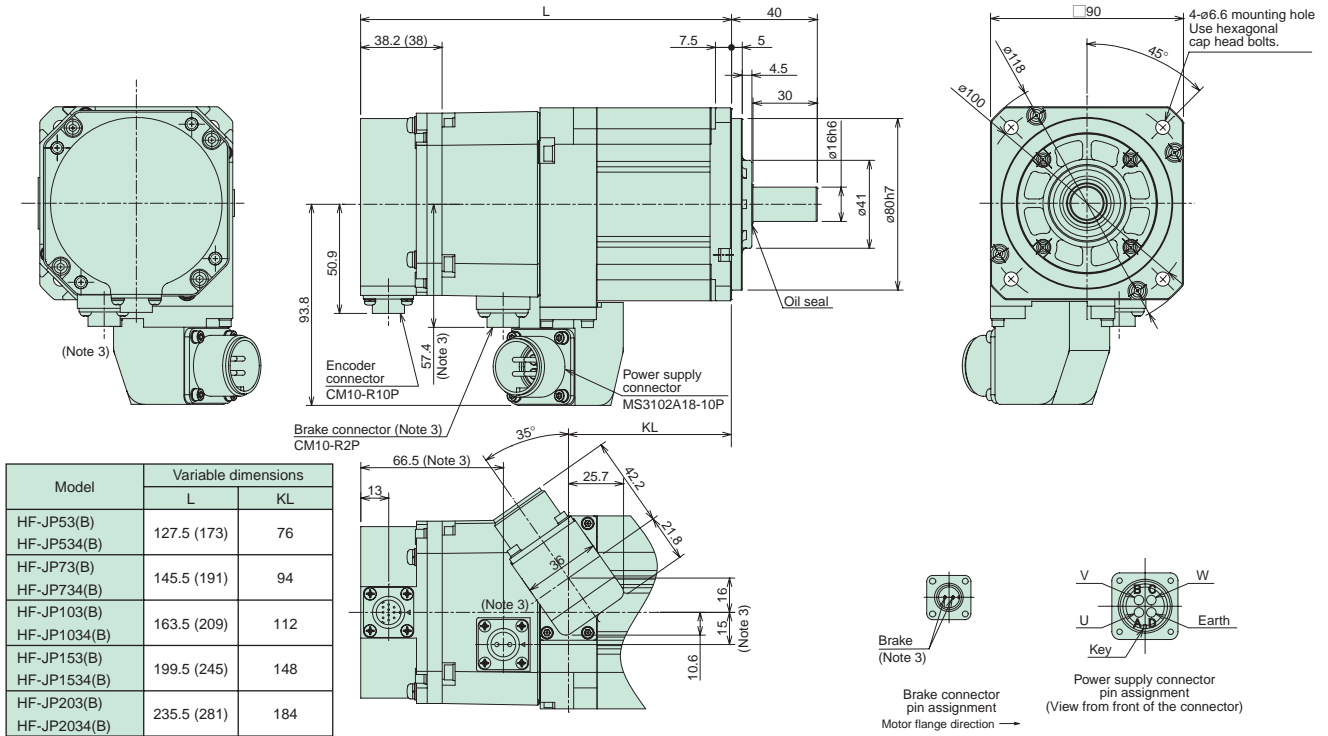

- HF-JP353(B), HF-JP503(B)

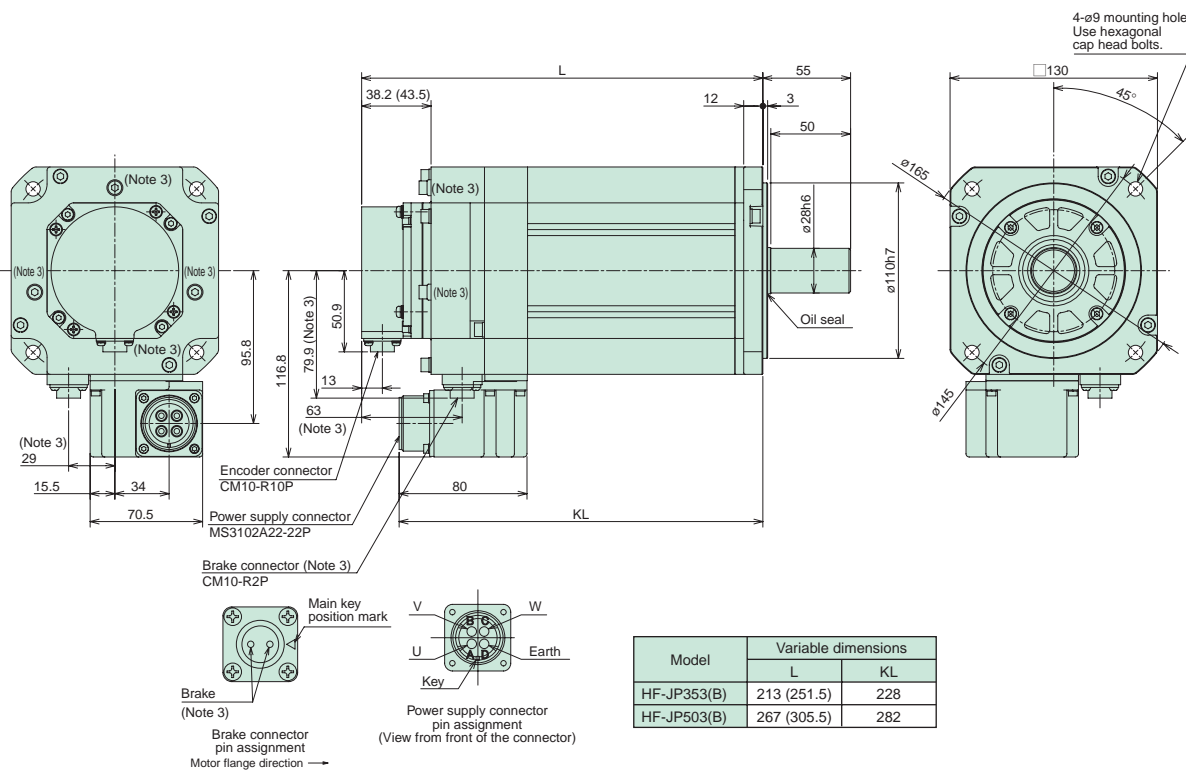

- Notes:
1. Use a friction coupling to fasten a load.
 2. Dimensions inside () are for the models with an electromagnetic brake.
 3. Only for the models with an electromagnetic brake. The electromagnetic brake terminals do not have polarity.
 4. For dimensions where there is no tolerance listed, use general tolerance.

(Unit: mm)

●HF-JP3534(B), HF-JP5034(B)

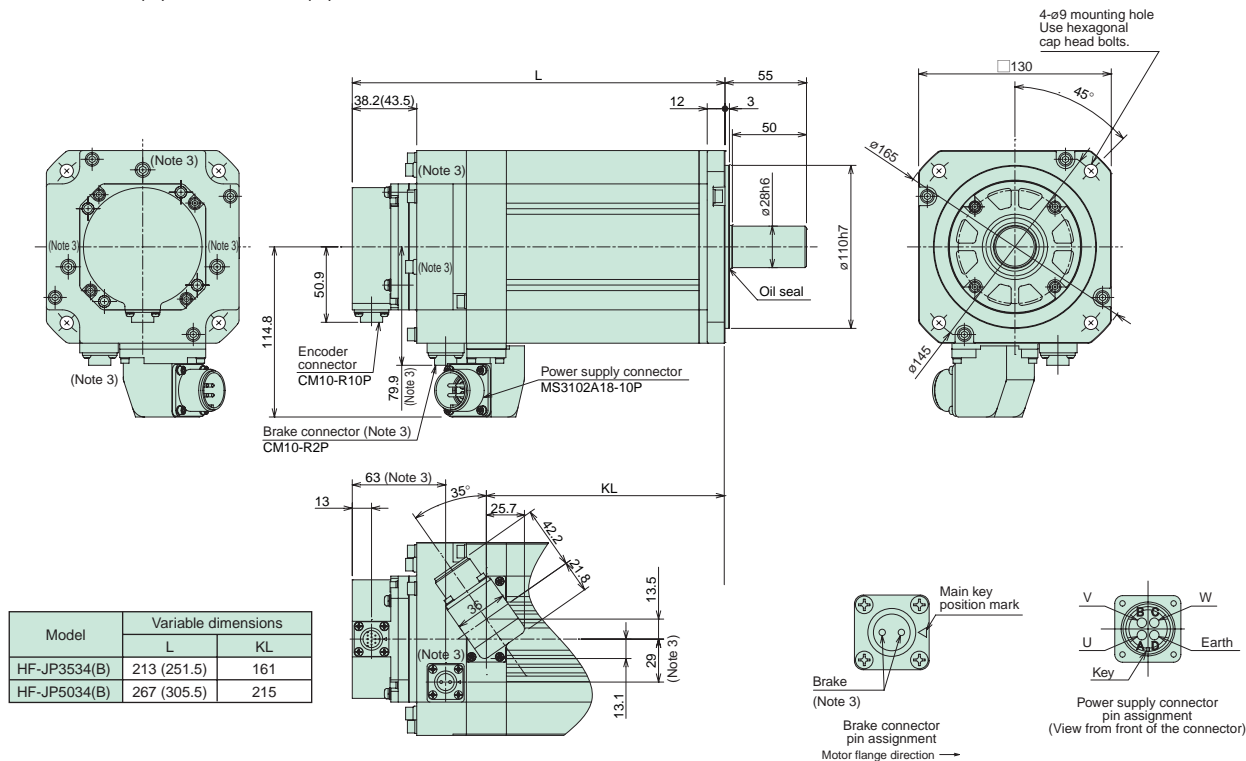

●HF-JP703(B), HF-JP903(B), HF-JP7034(B), HF-JP9034(B)

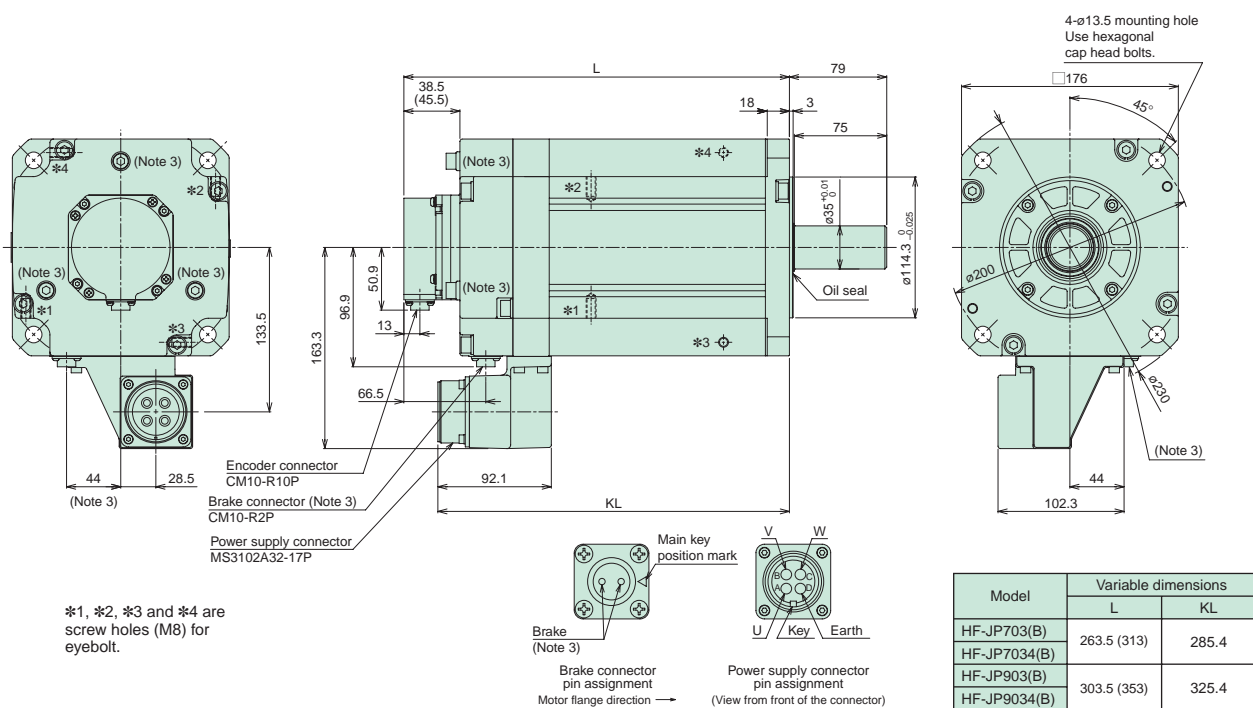

*1, *2, *3 and *4 are screw holes (M8) for eyebolt.

- Notes: 1. Use a friction coupling to fasten a load.
 2. Dimensions inside () are for the models with an electromagnetic brake.
 3. Only for the models with an electromagnetic brake. The electromagnetic brake terminals do not have polarity.
 4. For dimensions where there is no tolerance listed, use general tolerance.

Model designation

Servo motors

Servo amplifiers

Options

Peripheral equipment

MR-J3-B Safety

MR-J3W series

Servo support software

Cautions

Warranty

Global FA centers

(Unit: mm)

●HC-LP52(B), HC-LP102(B), HC-LP152(B)

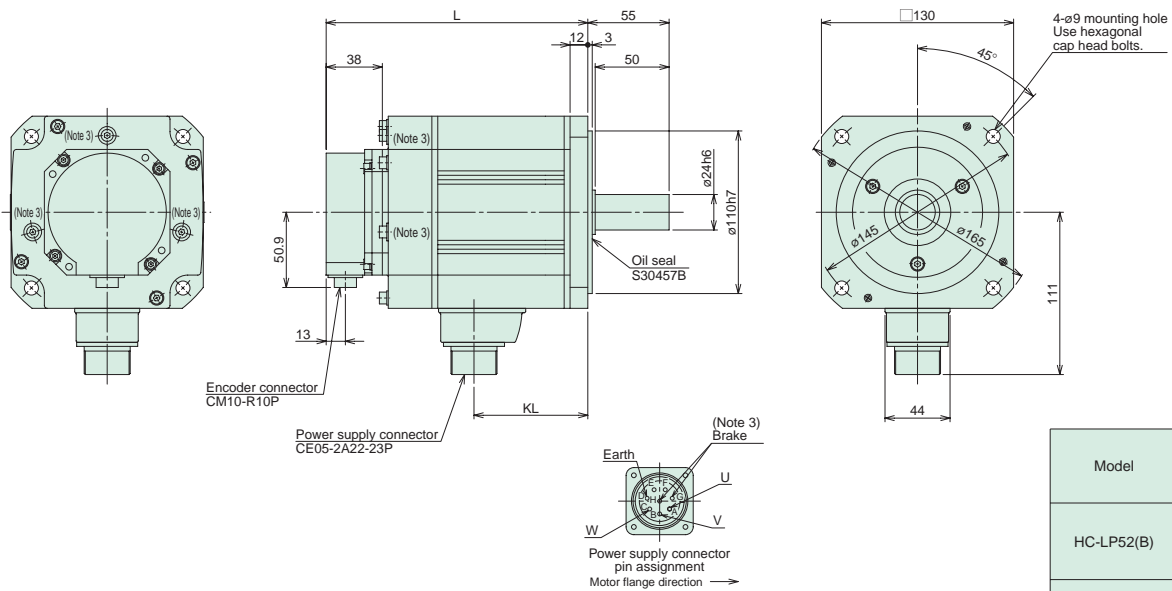

Model	Variable dimensions	
	L	KL
HC-LP52(B)	144 (177)	77
HC-LP102(B)	164 (197)	97
HC-LP152(B)	191.5 (224.5)	124.5

●HC-LP202(B), HC-LP302(B)

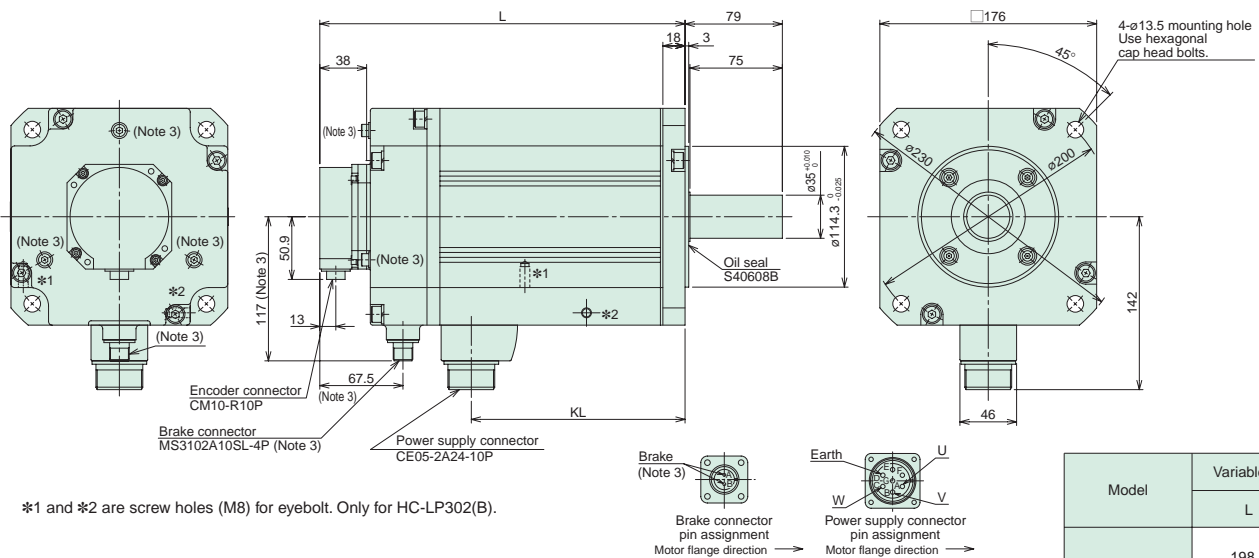

*1 and *2 are screw holes (M8) for eyebolt. Only for HC-LP302(B).

Model	Variable dimensions	
	L	KL
HC-LP202(B)	198.5 (246.5)	123.5
HC-LP302(B)	248.5 (296.5)	173.5

- Notes: 1. Use a friction coupling to fasten a load.
 2. Dimensions inside () are for the models with an electromagnetic brake.
 3. Only for the models with an electromagnetic brake. The electromagnetic brake terminals do not have polarity.
 4. For dimensions where there is no tolerance listed, use general tolerance.

Model designation

Servo motors

Servo amplifiers

Options

Peripheral equipment

MR-J3-B Safety

MR-J3W series

Servo support software

Cautions

Warranty

Global FA centers

MELSERVO-J3

Servo Motor Dimensions

(Unit: mm)

● HC-RP103(B), HC-RP153(B), HC-RP203(B)

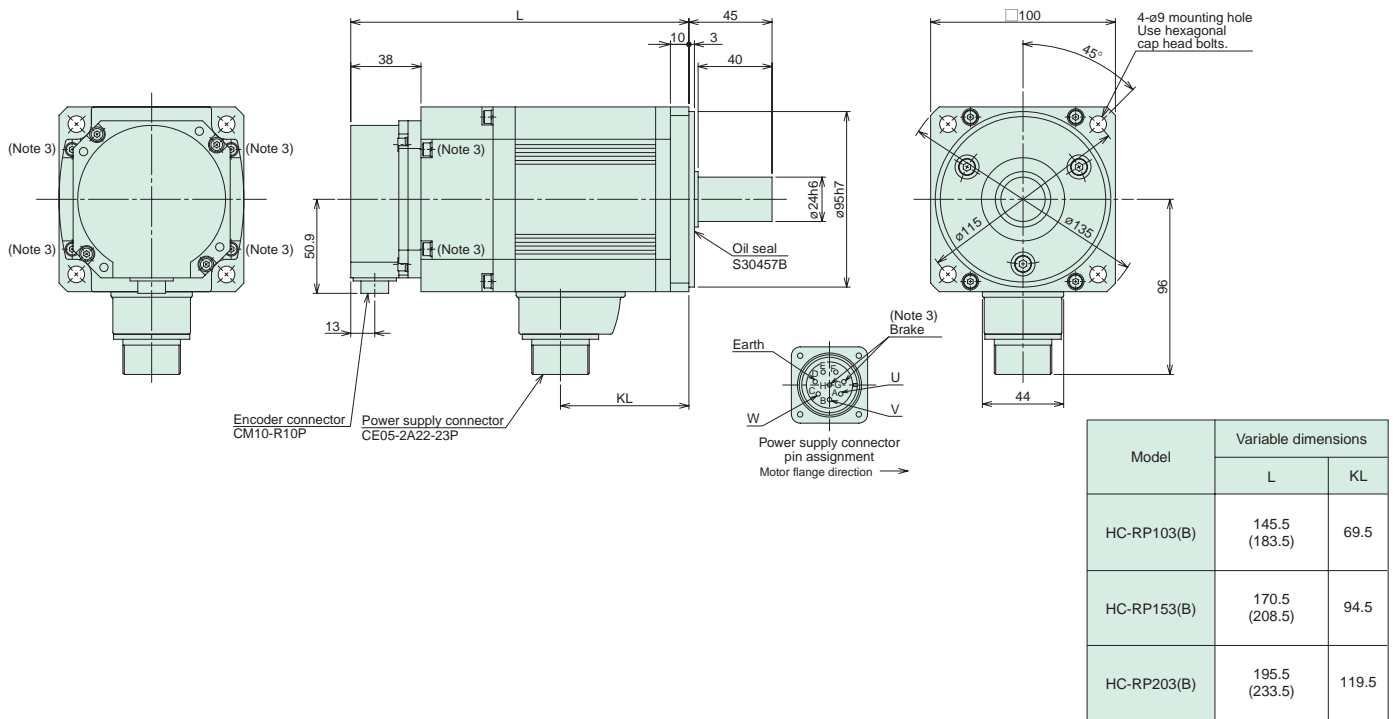

● HC-RP353(B), HC-RP503(B)

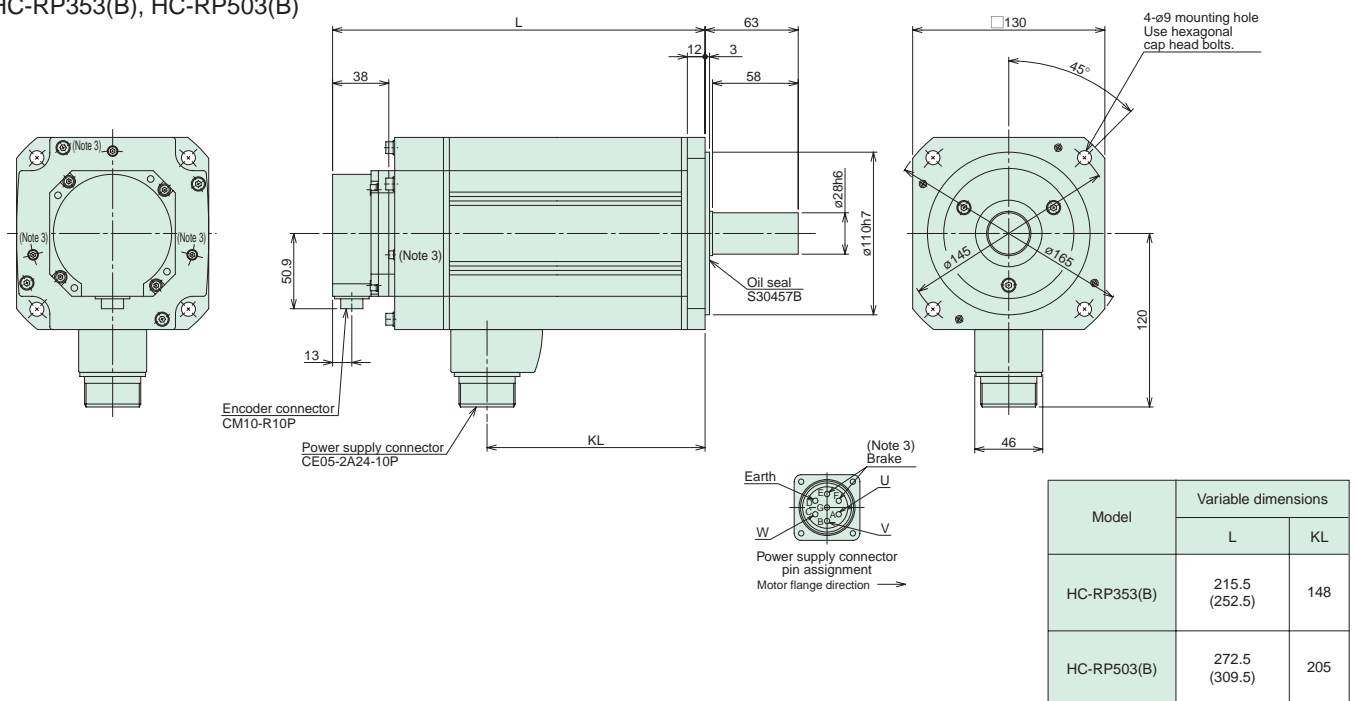

- Notes: 1. Use a friction coupling to fasten a load.
 2. Dimensions inside () are for the models with an electromagnetic brake.
 3. Only for the models with an electromagnetic brake. The electromagnetic brake terminals do not have polarity.
 4. For dimensions where there is no tolerance listed, use general tolerance.

(Unit: mm)

●HC-UP72(B), HC-UP152(B)

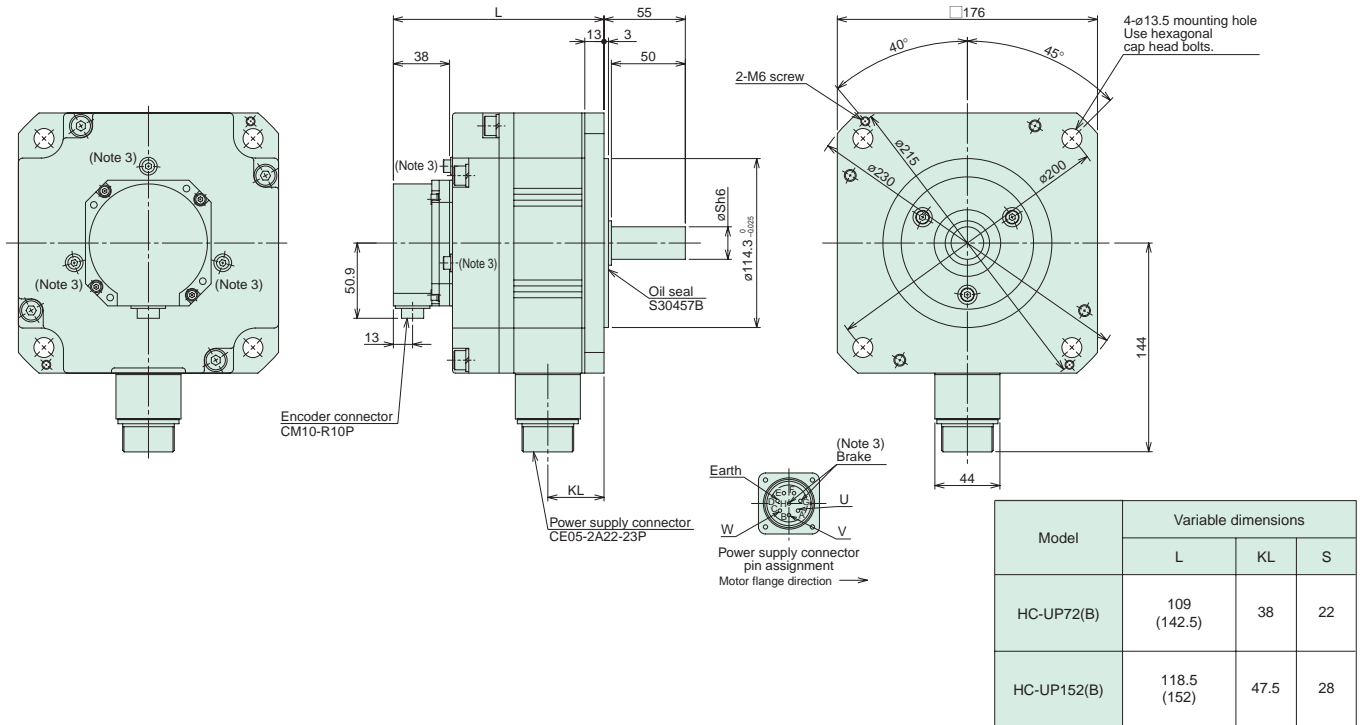

●HC-UP202(B), HC-UP352(B), HC-UP502(B)

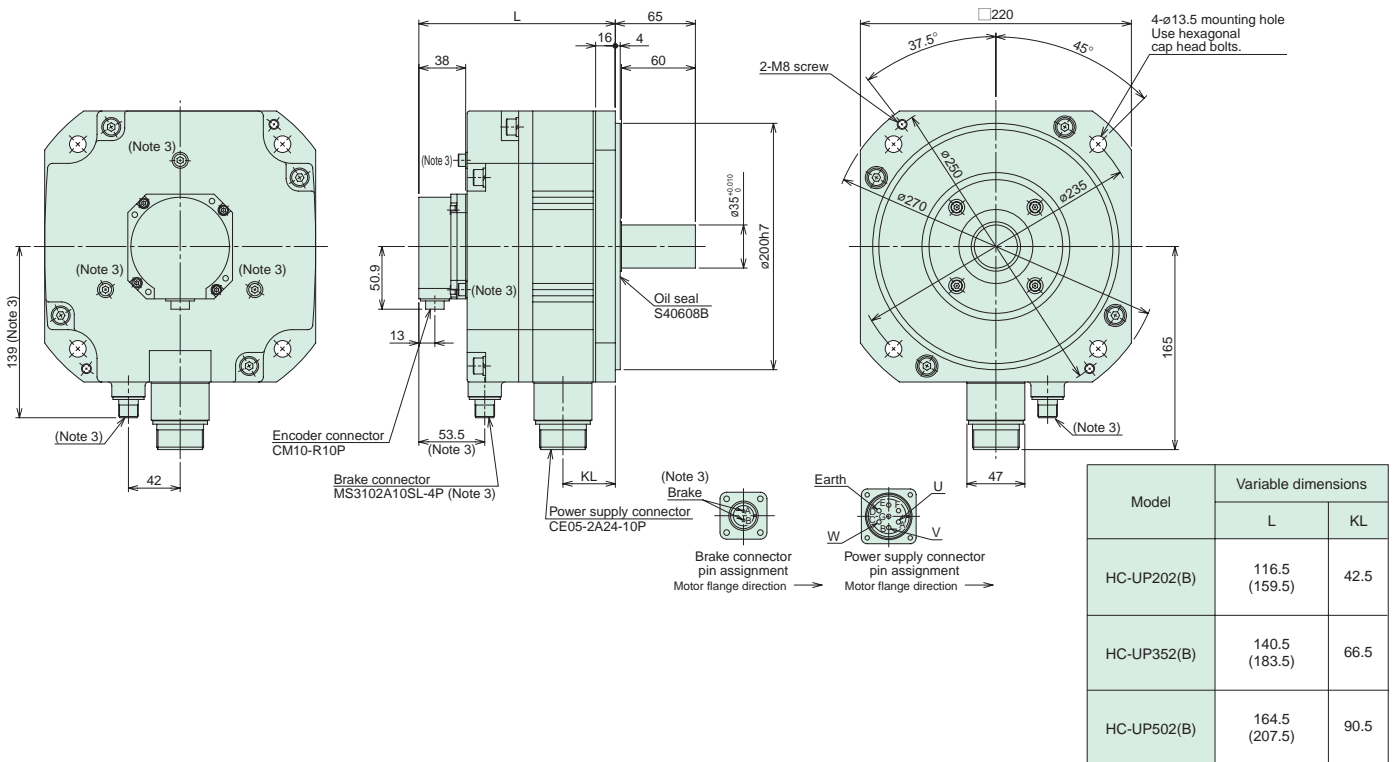

- Notes: 1. Use a friction coupling to fasten a load.
 2. Dimensions inside () are for the models with an electromagnetic brake.
 3. Only for the models with an electromagnetic brake. The electromagnetic brake terminals do not have polarity.
 4. For dimensions where there is no tolerance listed, use general tolerance.

Model designation

Servo motors

Servo amplifiers

Options

Peripheral equipment

MR-J3-B Safety

MR-J3W series

Servo support software

Cautions

Warranty

Global FA centers

MELSERVO-J3

Servo Motor Dimensions

(Unit: mm)

● HA-LP502

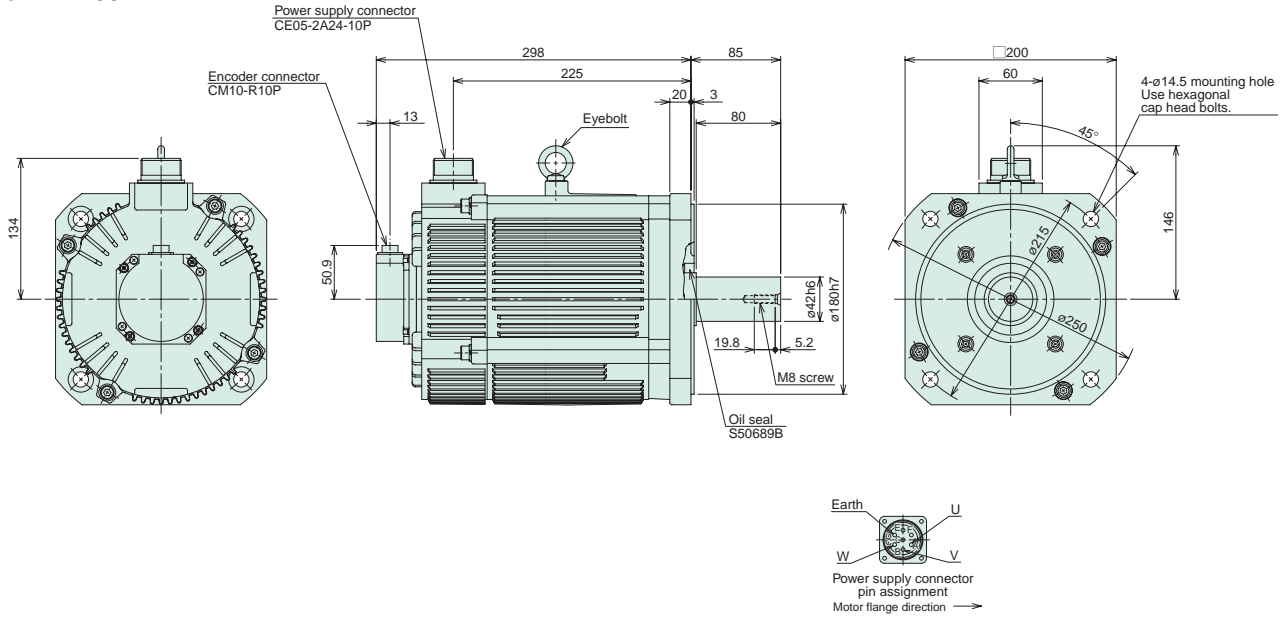

● HA-LP702

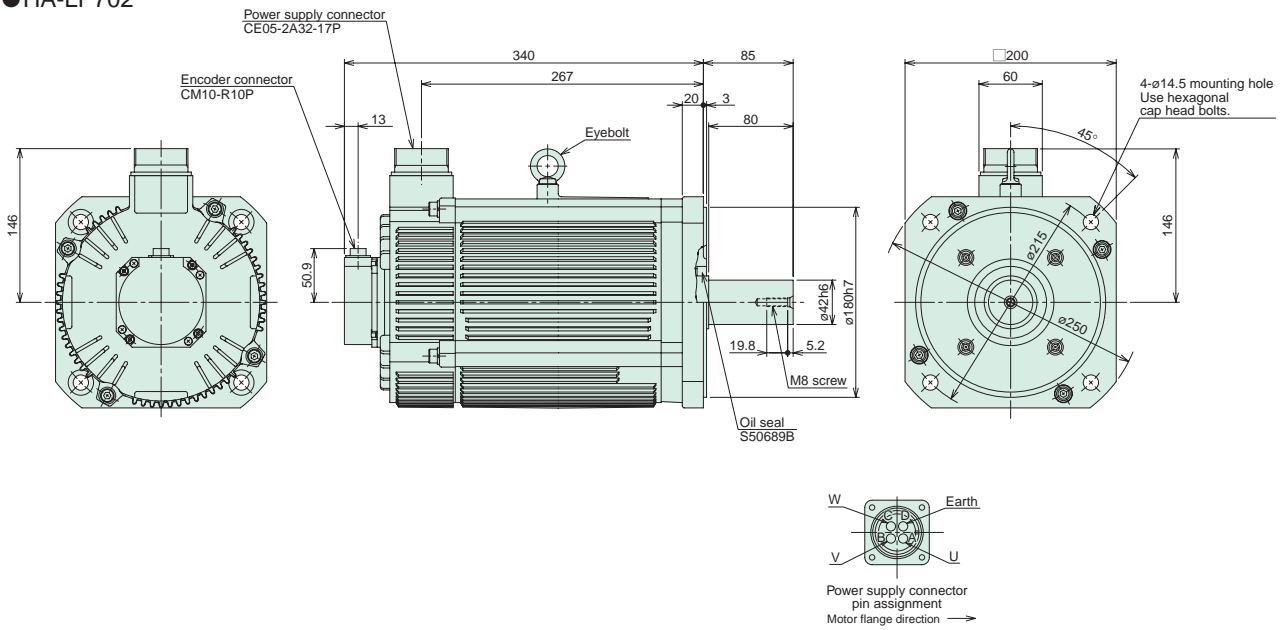

Notes: 1. Use a friction coupling to fasten a load.
2. For dimensions where there is no tolerance listed, use general tolerance.

(Unit: mm)

- HA-LP601(B), HA-LP6014(B)
- HA-LP701M(B), HA-LP701M4(B)
- HA-LP11K2(B), HA-LP11K24(B)

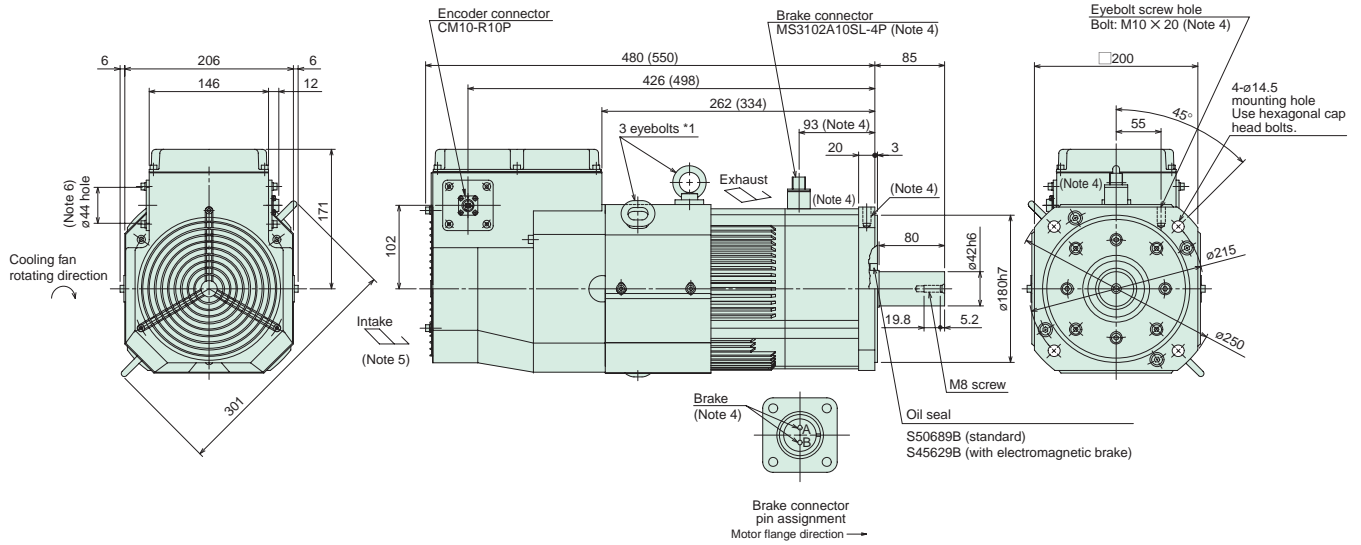

*1 When using the motor without the eyebolt, plug the threaded hole with a bolt of M10 X 20 or shorter.

*2 The terminal block on the terminal box housing consists of M6 screws for the motor power supply (U, V, W), and M4 screws for the cooling fan (BU, BV) and for the thermal protector (OHS1, OHS2).

- HA-LP801(B), HA-LP12K1(B), HA-LP8014(B), HA-LP12K14(B)
- HA-LP11K1M(B), HA-LP15K1M(B), HA-LP11K1M4(B), HA-LP15K1M4(B)
- HA-LP15K2(B), HA-LP22K2(B), HA-LP15K24(B), HA-LP22K24(B)

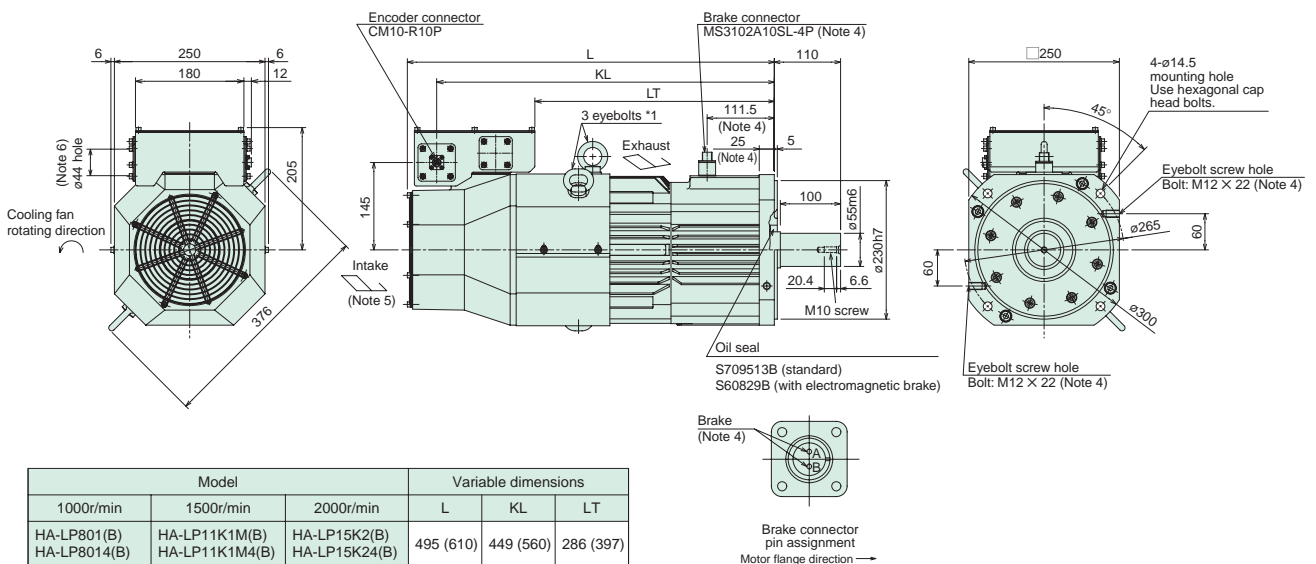

Model			Variable dimensions		
1000r/min	1500r/min	2000r/min	L	KL	LT
HA-LP801(B)	HA-LP11K1M(B)	HA-LP15K2(B)	495 (610)	449 (560)	286 (397)
HA-LP8014(B)	HA-LP11K1M4(B)	HA-LP15K24(B)			
HA-LP12K1(B)	HA-LP15K1M(B)	HA-LP22K2(B)	555 (670)	509 (620)	346 (457)
HA-LP12K14(B)	HA-LP15K1M4(B)	HA-LP22K24(B)			

*1 When using the motor without the eyebolt, plug the threaded hole with a bolt of M12 X 20 or shorter.

*2 The terminal block on the terminal box housing consists of M8 screws for the motor power supply (U, V, W), and M4 screws for the cooling fan (BU, BV, BW) and for the thermal protector (OHS1, OHS2).

- Notes:
1. Use a friction coupling to fasten a load.
 2. For dimensions where there is no tolerance listed, use general tolerance.
 3. Dimensions inside () are for the models with an electromagnetic brake.
 4. Only for the models with an electromagnetic brake. The electromagnetic brake terminals do not have polarity.
 5. Leave a clearance of at least 100mm between the motor's intake side and wall.
 6. Make sure that oil, water and dust, etc., will not enter the motor from the lead-in hole.

Model designation

Servo motors

Servo amplifiers

Options

Peripheral equipment

MR-J3-B Safety

MR-J3W series

Servo support software

Cautions

Warranty

Global FA centers

MELSERVO-J3

Servo Motor Dimensions

(Unit: mm)

- HA-LP15K1, HA-LP20K1, HA-LP15K14, HA-LP20K14
- HA-LP22K1M, HA-LP22K1M4, HA-LP30K1M4
- HA-LP30K24, HA-LP37K24

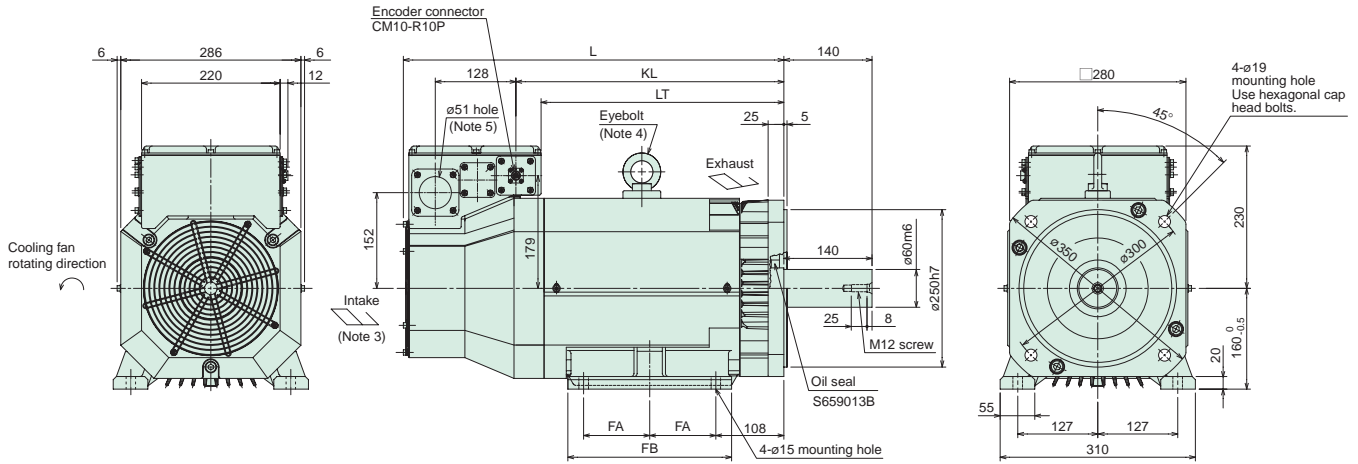

Model			Variable dimensions				
1000r/min	1500r/min	2000r/min	L	KL	LT	FA	FB
HA-LP15K1 HA-LP15K14	HA-LP22K1M HA-LP22K1M4	HA-LP30K24	605	426	386	105	260
HA-LP20K1 HA-LP20K14	HA-LP30K1M4	HA-LP37K24	650	471	431	127	304

* The terminal block on the terminal box housing consists of M8 screws for the motor power supply (U, V, W), and M4 screws for the cooling fan (BU, BV, BW) and for the thermal protector (OHS1, OHS2).

- HA-LP25K1, HA-LP30K1, HA-LP25K14, HA-LP30K14
- HA-LP37K1M, HA-LP37K1M4, HA-LP45K1M4
- HA-LP45K24, HA-LP55K24

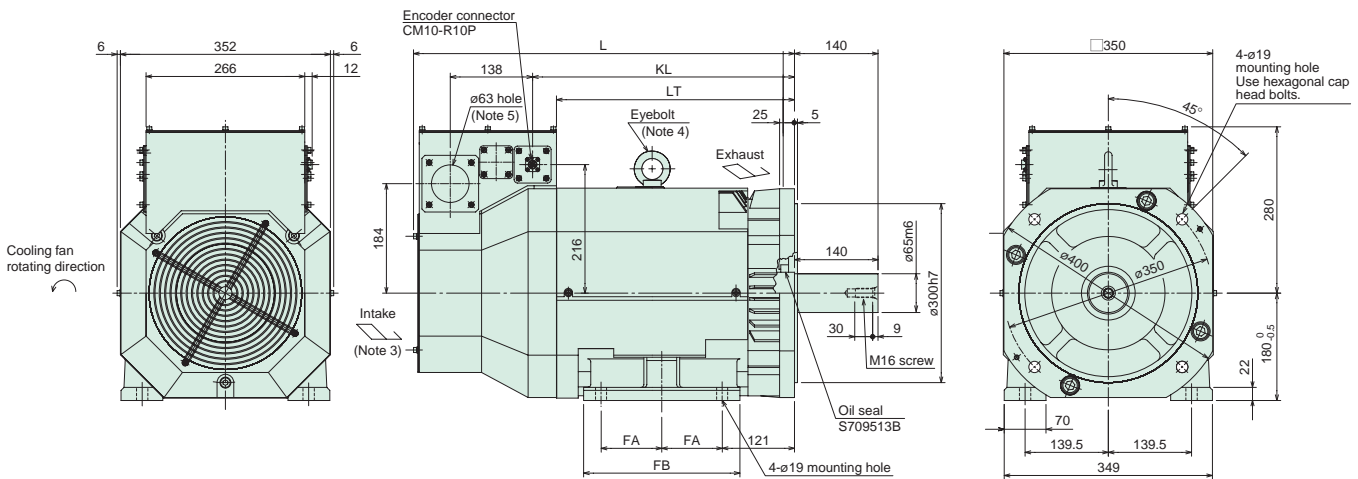

Model			Variable dimensions				
1000r/min	1500r/min	2000r/min	L	LT	KL	FA	FB
HA-LP25K1 HA-LP25K14	HA-LP37K1M HA-LP37K1M4	HA-LP45K24	640	399	439	101.5	262
HA-LP30K1 HA-LP30K14	HA-LP45K1M4	HA-LP55K24	685	444	484	120.5	300

* The terminal block on the terminal box housing consists of M10 screws for the motor power supply (U, V, W), and M4 screws for the cooling fan (BU, BV, BW) and for the thermal protector (OHS1, OHS2).

- Notes:
1. Use a friction coupling to fasten a load.
 2. For dimensions where there is no tolerance listed, use general tolerance.
 3. Leave a clearance of at least 150mm between the motor's intake side and wall.
 4. When using the motor without the eyebolt, plug the threaded hole with a bolt of M16 X 20 or shorter.
 5. Make sure that oil, water and dust, etc., will not enter the motor from the lead-in hole.
 6. When mounting the motor with the shaft horizontal, fix the motor either with the feet or the flange, keeping the feet downward. Note that when fixing the motor with the flange, also fix the feet to support the motor.

(Unit: mm)

- HA-LP30K1M
- HA-LP30K2, HA-LP37K2

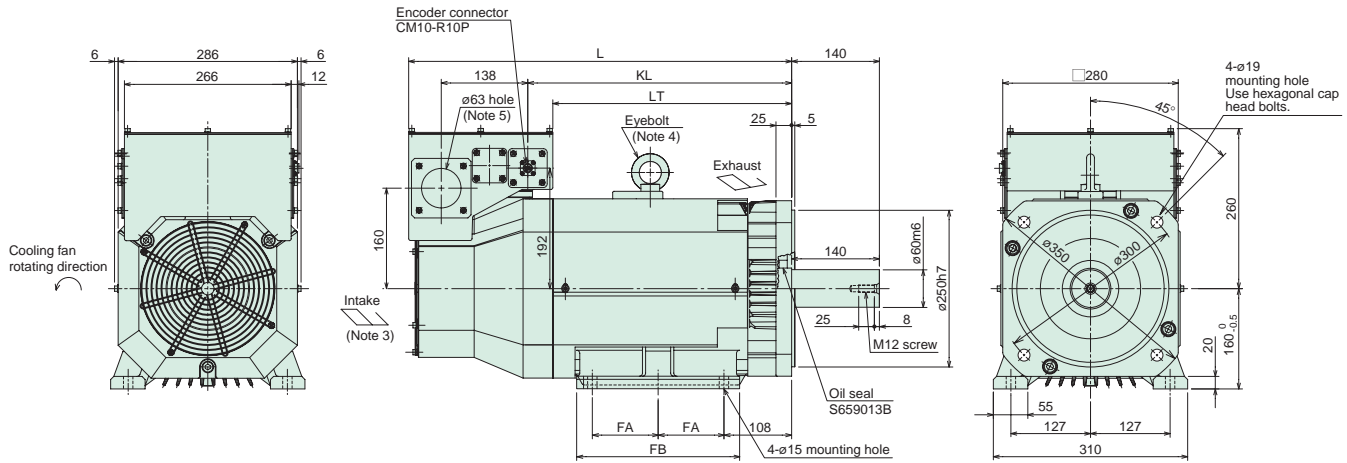

Model		Variable dimensions				
1500r/min	2000r/min	L	LT	KL	FA	FB
-	HA-LP30K2	615	381	421	105	260
HA-LP30K1M	HA-LP37K2	660	426	466	127	304

* The terminal block on the terminal box housing consists of M10 screws for the motor power supply (U, V, W), and M4 screws for the cooling fan (BU, BV, BW) and for the thermal protector (OHS1, OHS2).

- HA-LP37K1, HA-LP37K14
- HA-LP50K1M4

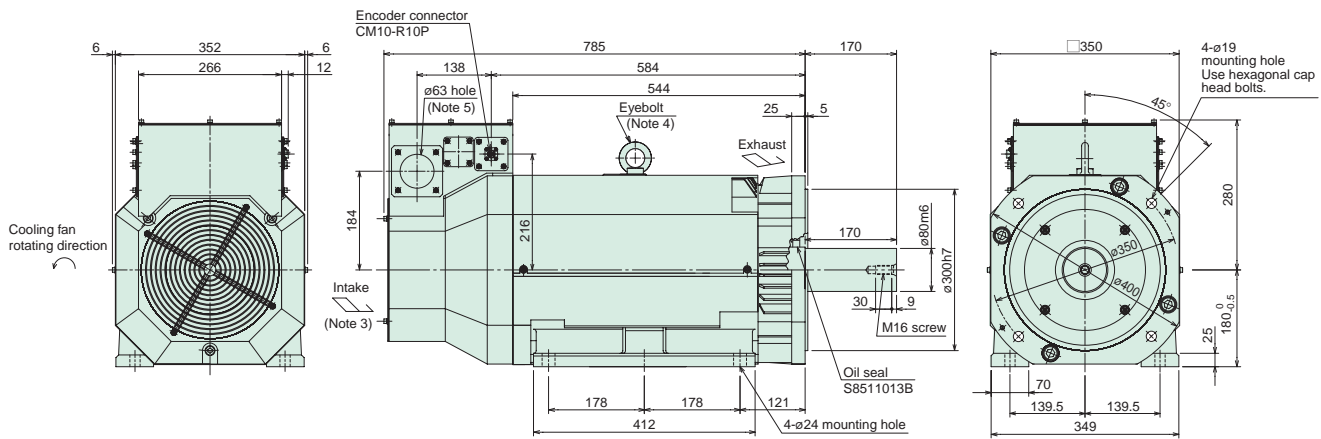

* The terminal block on the terminal box housing consists of M10 screws for the motor power supply (U, V, W), and M4 screws for the cooling fan (BU, BV, BW) and for the thermal protector (OHS1, OHS2).

- Notes:
1. Use a friction coupling to fasten a load.
 2. For dimensions where there is no tolerance listed, use general tolerance.
 3. Leave a clearance of at least 150mm between the motor's intake side and wall.
 4. When using the motor without the eyebolt, plug the threaded hole with a bolt of M16 X 20 or shorter.
 5. Make sure that oil, water and dust, etc., will not enter the motor from the lead-in hole.
 6. When mounting the motor with the shaft horizontal, fix the motor either with the feet or the flange, keeping the feet downward. Note that when fixing the motor with the flange, also fix the feet to support the motor.

Model designation
Servo motors
Servo amplifiers
Options
Peripheral equipment
MR-J3-B Safety
MR-J3W series
Servo support software
Cautions
Warranty
Global FA centers

MELSERVO-J3

Electromagnetic Brake Specifications (Note 1)

Servo motor model		HF-KP/HF-MP					HF-SP 1000r/min					
		053B	13B	23B	43B	73B	51B	81B	121B	201B	301B	421B
Type		Spring-action safety brake					Spring-action safety brake					
Rated voltage		24VDC $^{0}_{-10}\%$					24VDC $^{0}_{-10}\%$					
Brake static friction torque	(N-m)	0.32	0.32	1.3	1.3	2.4	8.5	8.5	44	44	44	44
	(oz-in)	45.3	45.3	184	184	340	1200	1200	6230	6230	6230	6230
Power consumption (W) at 20°C (68°F)		6.3	6.3	7.9	7.9	10	20	20	34	34	34	34
Permissible braking work	(J)/time	5.6	5.6	22	22	64	400	400	4500	4500	4500	4500
	(J)/hour	56	56	220	220	640	4000	4000	45000	45000	45000	45000
Brake life (Note 2)	Number of times	20000	20000	20000	20000	20000	20000	20000	20000	20000	20000	20000
	Work per braking (J)	5.6	5.6	22	22	64	200	200	1000	1000	1000	1000

Servo motor model		HF-SP 2000r/min					
		52(4)B	102(4)B	152(4)B	202(4)B	352(4)B	502(4)B
Type		Spring-action safety brake					
Rated voltage		24VDC $^{0}_{-10}\%$					
Brake static friction torque	(N-m)	8.5	8.5	8.5	44	44	44
	(oz-in)	1200	1200	1200	6230	6230	6230
Power consumption (W) at 20°C (68°F)		20	20	20	34	34	34
Permissible braking work	(J)/time	400	400	400	4500	4500	4500
	(J)/hour	4000	4000	4000	45000	45000	45000
Brake life (Note 2)	Number of times	20000	20000	20000	20000	20000	20000
	Work per braking (J)	200	200	200	1000	1000	1000

Servo motor model		HF-JP 3000r/min								HF-JP 1500r/min		
		53(4)B	73(4)B	103(4)B	153(4)B	203(4)B	353(4)B	503(4)B	703(4)B	903(4)B	11K1M(4)B	15K1M(4)B
Type		Spring-action safety brake										
Rated voltage		24VDC $^{0}_{-10}\%$										
Brake static friction torque	(N-m)	6.6	6.6	6.6	6.6	6.6	16	16	44	44	127	127
	(oz-in)	935	935	935	935	935	2270	2270	6230	6230	18000	18000
Power consumption (W) at 20°C (68°F)		11.7	11.7	11.7	11.7	11.7	23	23	34	34	32	32
Permissible braking work	(J)/time	64	64	64	64	64	400	400	4500	4500	5000	5000
	(J)/hour	640	640	640	640	640	4000	4000	45000	45000	45200	45200
Brake life (Note 2)	Number of times	5000	5000	5000	5000	5000	5000	5000	20000	20000	20000	20000
	Work per braking (J)	64	64	64	64	64	400	400	1000	1000	400	400

Servo motor model		HC-LP				HC-RP					
		52B	102B	152B	202B	302B	103B	152B	203B	353B	503B
Type		Spring-action safety brake				Spring-action safety brake					
Rated voltage		24VDC $^{0}_{-10}\%$				24VDC $^{0}_{-10}\%$					
Brake static friction torque	(N-m)	8.5	8.5	8.5	44	44	7	7	7	17	17
	(oz-in)	1200	1200	1200	6230	6230	991	991	991	2410	2410
Power consumption (W) at 20°C (68°F)		19	19	19	34	34	19	19	19	23	23
Permissible braking work	(J)/time	400	400	400	4500	4500	400	400	400	400	400
	(J)/hour	4000	4000	4000	45000	45000	4000	4000	4000	4000	4000
Brake life (Note 2)	Number of times	20000	20000	20000	20000	20000	20000	20000	20000	20000	20000
	Work per braking (J)	200	200	200	1000	1000	200	200	200	200	200

Servo motor model		HC-UP				HA-LP 1000r/min			
		72B	152B	202B	352B	502B	601(4)B	801(4)B	12K1(4)B
Type		Spring-action safety brake				Spring-action safety brake			
Rated voltage		24VDC $^{0}_{-10}\%$				24VDC $^{0}_{-10}\%$			
Brake static friction torque	(N-m)	8.5	8.5	44	44	44	82	160.5	160.5
	(oz-in)	1200	1200	6230	6230	6230	11600	22700	22700
Power consumption (W) at 20°C (68°F)		19	19	34	34	34	30	46	46
Permissible braking work	(J)/time	400	400	4500	4500	4500	3000	5000	5000
	(J)/hour	4000	4000	45000	45000	45000	30000	50000	50000
Brake life (Note 2)	Number of times	20000	20000	20000	20000	20000	20000	20000	20000
	Work per braking (J)	200	200	1000	1000	1000	1000	3000	3000

Servo motor model		HA-LP 1500r/min			HA-LP 2000r/min		
		701M(4)B	11K1M(4)B	15K1M(4)B	11K2(4)B	15K2(4)B	22K2(4)B
Type		Spring-action safety brake			Spring-action safety brake		
Rated voltage		24VDC $^{0}_{-10}\%$			24VDC $^{0}_{-10}\%$		
Brake static friction torque	(N-m)	82	160.5	160.5	82	160.5	160.5
	(oz-in)	11600	22700	22700	11600	22700	22700
Power consumption (W) at 20°C (68°F)		30	46	46	30	46	46
Permissible braking work	(J)/time	3000	5000	5000	3000	5000	5000
	(J)/hour	30000	50000	50000	30000	50000	50000
Brake life (Note 2)	Number of times	20000	20000	20000	20000	20000	20000
	Work per braking (J)	1000	3000	3000	1000	3000	3000

Notes: 1. The electromagnetic brake is for holding. It cannot be used for deceleration applications.
2. The brake gap cannot be adjusted. The brake life shows time until the readjustment is needed.

Special Shaft End Specifications

Motors with the following specifications are available.

HF-KP/HF-MP series

- D-cut shaft (Note 1) (50, 100W)

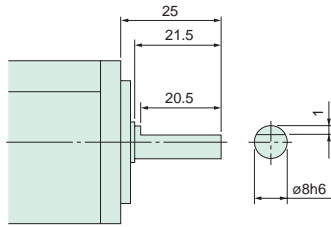

(Unit: mm)

- Keyway shaft with key (Note 1) (200, 400, 750W)

Servo motor model	Capacity (W)	Variable dimensions								
		T	S	R	Q	W	QK	QL	U	Y
HF-KP□K HF-MP□K	200, 400	5	14h6	30	27	5	20	3	3	M4 screw Depth: 15mm
	750	6	19h6	40	37	6	25	5	3.5	M5 screw Depth: 20mm

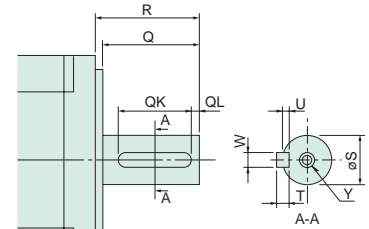

(Unit: mm)

HF-SP / HF-JP / HC-LP / HC-RP / HC-UP / HA-LP series

- Keyway shaft without key (Note 1, 2)

Servo motor model	Capacity (kW)	Variable dimensions										Fig.	
		S	R	Q	W	QK	QL	U	r	Y			
HF-SP□K (Note 3)	0.5 to 1.5	24h6	55	50	8 ⁰ _{-0.036}	36	5	4 ^{+0.2} ₀	4	M8 screw Depth: 20mm	A		
HC-LP□K	2.0 to 7.0	35 ^{+0.01} ₀	79	75	10 ⁰ _{-0.036}	55	5	5 ^{+0.2} ₀	5				
HC-RP□K	1.0, 1.5, 2.0	24h6	45	40	8 ⁰ _{-0.036}	25	5	4 ^{+0.2} ₀	4				
	3.5, 5.0	28h6	63	58	8 ⁰ _{-0.036}	53	3	4 ^{+0.2} ₀	4				
HC-UP□K	0.75	22h6	55	50	6 ⁰ _{-0.036}	42	3	3.5 ^{+0.1} ₀	3				
	1.5	28h6	55	50	8 ⁰ _{-0.036}	40	3	4 ^{+0.2} ₀	4				
HF-JP□K	0.5 to 2.0	16h6	40	30	5 ⁰ _{-0.030}	25	2	3 ^{+0.1} ₀	2.5			M4 screw Depth: 15mm	A
	3.5, 5.0	28h6	55	50	8 ⁰ _{-0.036}	36	5	4 ^{+0.2} ₀	4			M8 screw Depth: 20mm	
	7.0, 9.0	35 ^{+0.01} ₀	79	75	10 ⁰ _{-0.036}	55	5	5 ^{+0.2} ₀	5			M8 screw Depth: 20mm	
	11, 15	55M6	116	110	16 ⁰ _{-0.04}	90	5	6 ^{+0.2} ₀	8			M10 screw Depth: 27mm	

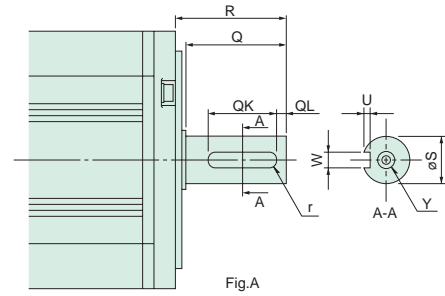

Fig.A

Servo motor model (HA-LP□K)	Variable dimensions										Fig.
	S	R	Q	W	QK	QL	U	r	Y		
601, 6014, 701M, 701M4, 502, 702, 11K2, 11K24	42h6	85	80	12 ⁰ _{-0.04}	70	5	5 ^{+0.2} ₀	6	Same as standard motor's straight shaft.	A	
801, 12K1, 8014, 12K14, 11K1M, 15K1M, 11K1M4, 15K1M4, 15K2, 22K2, 15K24, 22K24	55m6	110	100	16 ⁰ _{-0.04}	90	5	6 ^{+0.2} ₀	8			
15K1, 20K1, 15K14, 20K14, 22K1M, 30K1M, 22K1M4, 30K1M4, 30K2, 37K2, 30K24, 37K24	60m6	140	140	18 ⁰ _{-0.04}	128	6	7 ^{+0.2} ₀	9			
25K1, 30K1, 25K14, 30K14, 37K1M, 37K1M4, 45K1M4, 45K24, 55K24	65m6	140	140	18 ⁰ _{-0.04}	128	6	7 ^{+0.2} ₀	9			
37K1, 37K14, 50K1M4	80m6	170	170	22 ⁰ _{-0.04}	147	11	9 ^{+0.2} ₀	11			
											B

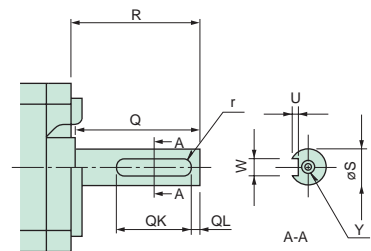

Fig.B

(Unit: mm)

- Notes: 1. The servo motors with keyway shaft (with/without key) or D-cut shaft cannot be used in frequent start/stop applications.
 2. A key is not supplied with the motor. The key shall be installed by the user.
 3. For HF-SP121K, the variable dimensions are same as the lower row, 2.0kW to 7.0kW.

MELSERVO-J3

MR-J3-A: Connections with Peripheral Equipment (Note 1)

Peripheral equipment is connected to MR-J3-A as described below.

Connectors, options, and other necessary equipment are available so that users can set up MR-J3-A easily and start using it right away.

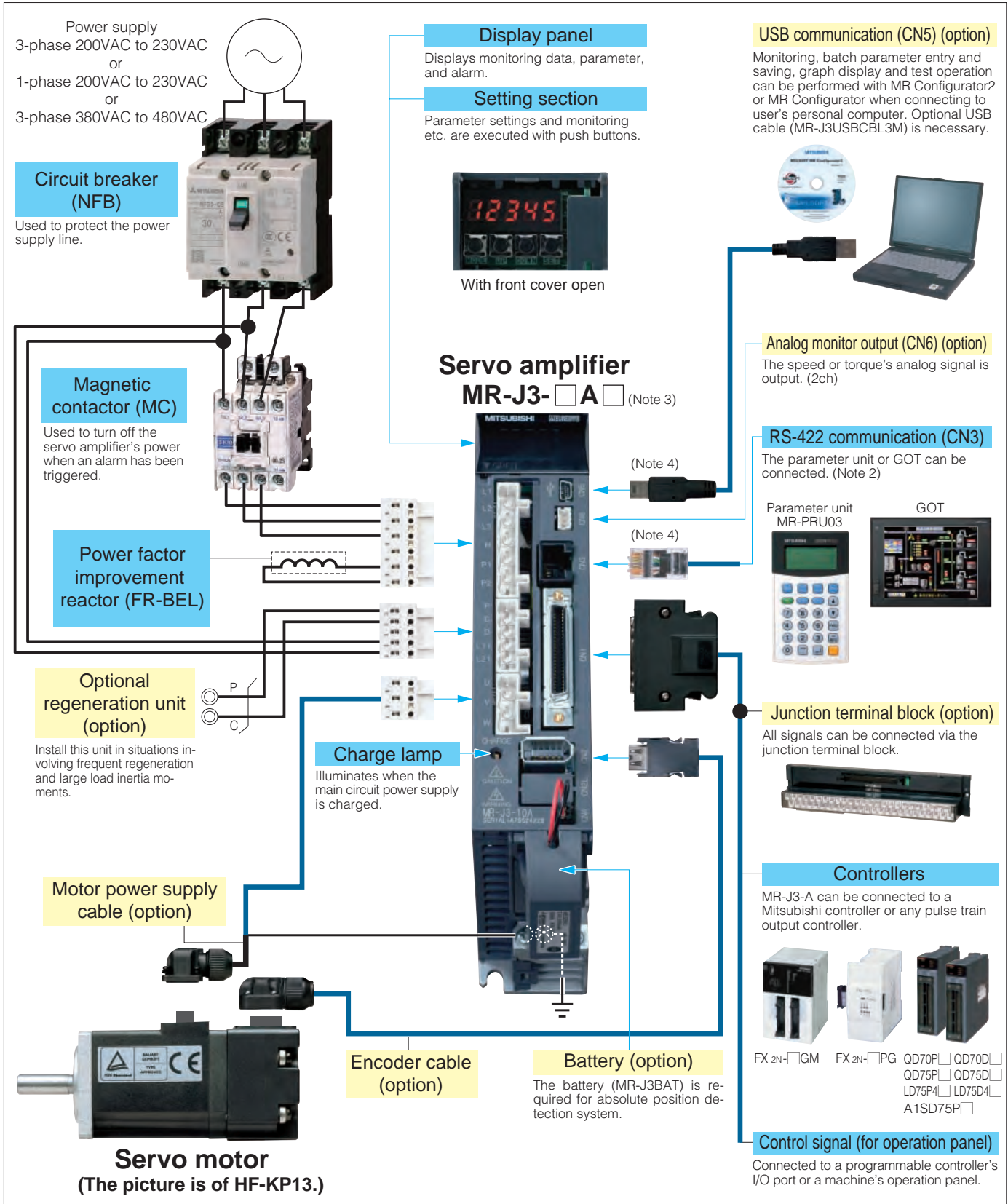

Notes: 1. Refer to "MR-J3-□A SERVO AMPLIFIER INSTRUCTION MANUAL" for the actual connections.

2. A personal computer can be connected using a RS-422/RS-232C conversion cable (refer to the section "Ordering Information for Customers" in this catalog). In this case, some functions of MR Configurator2 and MR Configurator may be limited.

3. The connections with peripheral equipment shown above is for the MR-J3-350A or smaller servo amplifier.

4. USB interface (CN5 connector) and RS-422 interface (CN3 connector) are mutually exclusive. They cannot be used at the same time.



MR-J3-A Servo Amplifier Specifications: 100VAC/200VAC, 22kW or Smaller

Servo amplifier model MR-J3-		10A	20A	40A	60A	70A	100A	200AN	350A	500A	700A	11KA	15KA	22KA	10A1	20A1	40A1	
Output	Rated voltage	3-phase 170VAC																
	Rated current (A)	1.1	1.5	2.8	3.2	5.8	6.0	11.0	17.0	28.0	37.0	68.0	87.0	126.0	1.1	1.5	2.8	
Main circuit power supply	Voltage/frequency (Note 1, 2)	3-phase 200 to 230VAC 50/60Hz or 1-phase 200 to 230VAC 50/60Hz (Note 10)					3-phase 200 to 230VAC 50/60Hz								1-phase 100 to 120VAC 50/60Hz			
	Rated current (A)	0.9	1.5	2.6	3.2	3.8	5.0	10.5	16.0	21.7	28.9	46.0	64.0	95.0	3.0	5.0	9.0	
	Permissible voltage fluctuation	For 3-phase 200 to 230VAC: 3-phase 170 to 253VAC For 1-phase 200 to 230VAC: 1-phase 170 to 253VAC (Note 10)					3-phase 170 to 253VAC								1-phase 85 to 132VAC			
	Permissible frequency fluctuation	±5% maximum																
Control circuit power supply	Voltage/frequency	1-phase 200 to 230VAC 50/60Hz (Note 10)					1-phase 200 to 230VAC 50/60Hz								1-phase 100 to 120VAC 50/60Hz			
	Rated current (A)	0.2					0.3					0.4						
	Permissible voltage fluctuation	1-phase 170 to 253VAC (Note 10)					1-phase 170 to 253VAC								1-phase 85 to 132VAC			
	Permissible frequency fluctuation	±5% maximum																
	Power consumption (W)	30					45					30						
Interface power supply		24VDC ±10% (required current capacity: 0.3A (Note 7))																
Tolerable regenerative power of regenerative resistor (W) (Note 3, 4)	Built-in regenerative resistor	—	10	10	10	20	20	100	100	130	170	—	—	—	—	10	10	
	External regenerative resistor (Standard accessory) (Note 5, 6)	—	—	—	—	—	—	—	—	—	—	500 (800)	850 (1300)	850 (1300)	—	—	—	
Control system		Sine-wave PWM control/current control system																
Dynamic brake		Built-in (Note 8, 13)										External option (Note 14)			Built-in (Note 8, 13)			
Safety features		Overcurrent shutdown, regeneration overvoltage shutdown, overload shutdown (electronic thermal), servo motor overheat protection, encoder fault protection, regeneration fault protection, undervoltage/sudden power outage protection, overspeed protection, excess error protection																
Position control mode	Maximum input pulse frequency	1Mpps (when using differential receiver), 200kpps (when using open collector), (4Mpps (Note 11))																
	Positioning feedback pulse	Encoder resolution: 262144 p/rev																
	Command pulse multiple	Electronic gear A/B multiple, A: 1 to 1048576, B: 1 to 1048576, 1/10 < A/B < 2000																
	Positioning complete width setting	0 to ±65535 pulses (command pulse unit)																
	Excess error	±3 rotations																
	Torque limit	Set by parameters or external analog input (0 to +10VDC/maximum torque)																
Speed control mode	Speed control range	Analog speed command 1:2000, internal speed command 1:5000																
	Analog speed command input	0 to ±10VDC/rated speed (possible to change the speed in 10V using parameter No. PC12.) (Note 12)																
	Speed fluctuation rate	±0.01% maximum (load fluctuation 0 to 100%), 0% (power fluctuation ±10%) ±0.2% maximum (ambient temperature 25°C±10°C (59°F to 95°F)), when using analog speed command																
	Torque limit	Set by parameters or external analog input (0 to +10VDC/maximum torque) (Note 12)																
Torque control mode	Analog torque command input	0 to ±8VDC/maximum torque (input impedance 10 to 12kΩ) (Note 12)																
	Speed limit	Set by parameters or external analog input (0 to ±10VDC/rated speed)																
Structure (IP rating)		Natural-cooling open (IP00)					Fan cooling open (IP00)								Natural-cooling open (IP00)			
Environment	Ambient temperature (Note 9)	0 to 55°C (32 to 131°F) (non freezing), storage: -20 to 65°C (-4 to 149°F) (non freezing)																
	Ambient humidity	90% RH maximum (non condensing), storage: 90% RH maximum (non condensing)																
	Atmosphere	Indoors (no direct sunlight); no corrosive gas, inflammable gas, oil mist or dust																
	Elevation	1000m or less above sea level																
	Vibration	5.9m/s ² or less at 10 to 55Hz (directions of X, Y and Z axes)																
Mass (kg [lb])		0.8 (1.8)	0.8 (1.8)	1.0 (2.2)	1.0 (2.2)	1.4 (3.1)	1.4 (3.1)	2.1 (4.6)	2.3 (5.1)	4.6 (10)	6.2 (14)	18 (40)	18 (40)	19 (42)	0.8 (1.8)	0.8 (1.8)	1.0 (2.2)	

- Notes: 1. Rated output and speed of a servo motor are applicable when the servo amplifier, combined with the servo motor, is operated within the specified power supply voltage and frequency. Torque drops when the power supply voltage is below the specified value.
2. For torque characteristics when combined with a servo motor, refer to the section "Servo motor torque characteristics" in this catalog.
3. Optimal regenerative resistor varies for each system. Select the most suitable regenerative resistor by using the capacity selection software.
4. Refer to the section "Options ● Optional regeneration unit" in this catalog for the tolerable regenerative power (W).
5. Servo amplifiers without an enclosed regenerative resistor are also available. Refer to "Servo Amplifier Model Designation" in this catalog for details.
6. The value in () is applicable when the external regenerative resistors, GRZG400-□Ω (standard accessory) are used with cooling fans (2 units of 92 X 92mm, minimum air flow: 1.0m³/min). Note that change in parameter No. PA02 is required.
7. 0.3A is the value when all of the input/output points are used. The current capacity can be stepped down according to the number of input/output points in use. Refer to "MR-J3-□A SERVO AMPLIFIER INSTRUCTION MANUAL" for details.
8. Special specification servo amplifiers without a dynamic brake are also available: MR-J3-□A(1)-ED. When using the servo amplifier without a dynamic brake, the servo motor does not stop immediately at alarm occurrence or power failure. Take measures to ensure safety on the entire system.
9. MR-J3-350A or smaller servo amplifiers can be mounted closely. In this case, operate them at the ambient temperature of 0 to 45°C (32 to 113°F) or at 75% or less of the effective load ratio.
10. Special specification servo amplifiers for 1-phase 200 to 240VAC are also available: MR-J3-□A-U004. The permissible voltage fluctuation for MR-J3-□A-U004 is 1-phase 170 to 264VAC.
11. 4Mpps compatible servo amplifier is also available: MR-J3-□A(1)-KE. Contact your local sales office for 4Mpps compatible servo amplifier for HF-JP11K1M and HF-JP15K1M.
12. High resolution analog speed command and analog torque command is available with a set of MR-J3-□A(1)-RJ040 and MR-J3-D01 extension IO unit.
13. When using the built-in dynamic brake, refer to "MR-J3-□A SERVO AMPLIFIER INSTRUCTION MANUAL" for the permissible load to motor inertia moment ratio.
14. Use an optional external dynamic brake with the servo amplifier. Without the external dynamic brake, a servo motor does not stop immediately at emergency stop and falls in free-run status, causing an accident such as machine collision, etc. Take measures to ensure safety on the entire system.



MR-J3-A Servo Amplifier Specifications: 200VAC, 30kW or Larger

		Drive unit model	MR-J3-DU30KA	MR-J3-DU37KA	
Drive unit	Output	Rated voltage	3-phase 170VAC		
		Rated current (A)	174	204	
	Main circuit power supply		The drive unit's main circuit power is supplied from the converter unit.		
	Control circuit power supply	Voltage/frequency	1-phase 200 to 230VAC 50/60Hz		
		Rated current (A)	0.3		
		Permissible voltage fluctuation	1-phase 170 to 253VAC		
		Permissible frequency fluctuation	±5% maximum		
		Power consumption (W)	45		
	Interface power supply		24VDC ±10% (required current capacity: 0.3A (Note 3))		
	Control system		Sine-wave PWM control/current control system		
	Dynamic brake		External option (Note 4)		
	Safety features		Overcurrent shutdown, overload shutdown (electronic thermal), servo motor overheat protection, encoder fault protection, undervoltage/sudden power outage protection, overspeed protection, excess error protection		
	Position control mode	Maximum input pulse frequency	1Mpps (when using differential receiver), 200kpps (when using open collector)		
		Positioning feedback pulse	Encoder resolution: 262144 p/rev		
		Command pulse multiple	Electronic gear A/B multiple, A: 1 to 1048576, B: 1 to 1048576, 1/10 < A/B < 2000		
		Positioning complete width setting	0 to ±65535 pulses (command pulse unit)		
		Excess error	±3 rotations		
		Torque limit	Set by parameters or external analog input (0 to +10VDC/maximum torque)		
	Speed control mode	Speed control range	Analog speed command 1:2000, internal speed command 1:5000		
		Analog speed command input	0 to ±10VDC/rated speed (possible to change the speed in 10V using parameter No. PC12.)		
Speed fluctuation rate		±0.01% maximum (load fluctuation 0 to 100%), 0% (power fluctuation ±10%) ±0.2% maximum (ambient temperature 25°C±10°C (59°F to 95°F)), when using analog speed command			
Torque limit		Set by parameters or external analog input (0 to +10VDC/maximum torque)			
Torque control mode	Analog torque command input	0 to ±8VDC/maximum torque (input impedance 10 to 12kΩ)			
	Speed limit	Set by parameters or external analog input (0 to ±10VDC/rated speed)			
Structure (IP rating)		Fan cooling open (IP00)			
Mass (kg [lb])		26 (57)			
Converter unit	Converter unit model		MR-J3-CR55K		
	Output	Rated voltage	283 to 326VDC		
		Rated current (A)	215.9		
	Main circuit power supply	Voltage/frequency (Note 1, 2)	3-phase 200 to 230VAC 50/60Hz		
		Rated current (A)	251.1		
		Permissible voltage fluctuation	3-phase 170 to 253VAC		
		Permissible frequency fluctuation	±5% maximum		
	Control circuit power supply	Voltage/frequency	1-phase 200 to 230VAC 50/60Hz		
		Rated current (A)	0.3		
		Permissible voltage fluctuation	1-phase 170 to 253VAC		
		Permissible frequency fluctuation	±5% maximum		
		Power consumption (W)	45		
	Interface power supply		24VDC ±10% (required current capacity: 0.13A (Note 3))		
	Safety features		Regeneration overvoltage shutdown, regeneration fault protection, overload shutdown (electronic thermal), undervoltage/sudden power outage protection		
	Structure (IP rating)		Fan cooling open (IP00)		
	Mass (kg [lb])		25 (55)		
	Drive unit/ Converter unit	Environment	Ambient temperature	0 to 55°C (32 to 131°F) (non freezing), storage: -20 to 65°C (-4 to 149°F) (non freezing)	
			Ambient humidity	90% RH maximum (non condensing), storage: 90% RH maximum (non condensing)	
			Atmosphere	Indoors (no direct sunlight); no corrosive gas, inflammable gas, oil mist or dust	
			Elevation	1000m or less above sea level	
Vibration			5.9m/s ² or less at 10 to 55Hz (directions of X, Y and Z axes)		

Notes: 1. Rated output and speed of a servo motor are applicable when the drive unit and the converter unit, combined with the servo motor, are operated within the specified power supply voltage and frequency. Torque drops when the power supply voltage is below the specified value.

2. For torque characteristics when combined with a servo motor, refer to the section "Servo motor torque characteristics" in this catalog.

3. The interface power supply can be shared with the drive unit and the converter unit. When all of the input/output points are used, 0.3A is required for the drive unit, and 0.13A is required for the converter unit. The current capacity can be stepped down according to the number of input/output points in use. Refer to "MR-J3-□A SERVO AMPLIFIER INSTRUCTION MANUAL" for details.

4. Use an optional external dynamic brake with the drive unit. Without the external dynamic brake, a servo motor does not stop immediately at emergency stop and falls in free-run status, causing an accident such as machine collision, etc. Take measures to ensure safety on the entire system.



MR-J3-A Servo Amplifier Specifications: 400VAC, 22kW or Smaller

Servo amplifier model MR-J3-		60A4	100A4	200A4	350A4	500A4	700A4	11KA4	15KA4	22KA4
Output	Rated voltage	3-phase 323VAC								
	Rated current (A)	1.5	2.8	5.4	8.6	14.0	17.0	32.0	41.0	63.0
Main circuit power supply	Voltage/frequency (Note 1, 2)	3-phase 380 to 480VAC 50/60Hz								
	Rated current (A)	1.4	2.5	5.1	7.9	10.8	14.4	23.1	31.8	47.6
	Permissible voltage fluctuation	3-phase 323 to 528VAC								
	Permissible frequency fluctuation	±5% maximum								
Control circuit power supply	Voltage/frequency	1-phase 380 to 480VAC 50/60Hz								
	Rated current (A)	0.1			0.2					
	Permissible voltage fluctuation	1-phase 323 to 528VAC								
	Permissible frequency fluctuation	±5% maximum								
Interface power supply		24VDC ±10% (required current capacity: 0.3A (Note 7))								
Tolerable regenerative power of regenerative resistor (W) (Note 3, 4)	Built-in regenerative resistor	15	15	100	100	130 (Note 9)	170 (Note 9)	—	—	—
	External regenerative resistor (Standard accessory) (Note 5, 6)	—	—	—	—	—	—	500 (800)	850 (1300)	850 (1300)
Control system		Sine-wave PWM control/current control system								
Dynamic brake		Built-in (Note 8, 10)					External option (Note 12)			
Safety features		Overcurrent shutdown, regeneration overvoltage shutdown, overload shutdown (electronic thermal), servo motor overheat protection, encoder fault protection, regeneration fault protection, undervoltage/sudden power outage protection, overspeed protection, excess error protection								
Position control mode	Maximum input pulse frequency	1Mpps (when using differential receiver), 200kpps (when using open collector)								
	Positioning feedback pulse	Encoder resolution: 262144 p/rev								
	Command pulse multiple	Electronic gear A/B multiple, A: 1 to 1048576, B: 1 to 1048576, 1/10 < A/B < 2000								
	Positioning complete width setting	0 to ±65535 pulses (command pulse unit)								
	Excess error	±3 rotations								
	Torque limit	Set by parameters or external analog input (0 to +10VDC/maximum torque)								
Speed control mode	Speed control range	Analog speed command 1:2000, internal speed command 1:5000								
	Analog speed command input	0 to ±10VDC/rated speed (possible to change the speed in 10V using parameter No. PC12.) (Note 11)								
	Speed fluctuation rate	±0.01% maximum (load fluctuation 0 to 100%), 0% (power fluctuation ±10%) ±0.2% maximum (ambient temperature 25°C±10°C (59°F to 95°F)), when using analog speed command								
	Torque limit	Set by parameters or external analog input (0 to +10VDC/maximum torque) (Note 11)								
Torque control mode	Analog torque command input	0 to ±8VDC/maximum torque (input impedance 10 to 12kΩ) (Note 11)								
	Speed limit	Set by parameters or external analog input (0 to ±10VDC/rated speed)								
Structure (IP rating)		Natural-cooling open (IP00)			Fan cooling open (IP00)					
Environment	Ambient temperature (Note 6)	0 to 55°C (32 to 131°F) (non freezing), storage: -20 to 65°C (-4 to 149°F) (non freezing)								
	Ambient humidity	90% RH maximum (non condensing), storage: 90% RH maximum (non condensing)								
	Atmosphere	Indoors (no direct sunlight); no corrosive gas, inflammable gas, oil mist or dust								
	Elevation	1000m or less above sea level								
Vibration		5.9m/s ² or less at 10 to 55Hz (directions of X, Y and Z axes)								
Mass (kg [lb])		1.7 (3.7)	1.7 (3.7)	2.1 (4.6)	4.6 (10)	4.6 (10)	6.2 (14)	18 (40)	18 (40)	19 (42)

- Notes: 1. Rated output and speed of a servo motor are applicable when the servo amplifier, combined with the servo motor, is operated within the specified power supply voltage and frequency. Torque drops when the power supply voltage is below the specified value.
2. For torque characteristics when combined with a servo motor, refer to the section "Servo motor torque characteristics" in this catalog.
3. Optimal regenerative resistor varies for each system. Select the most suitable regenerative resistor by using the capacity selection software.
4. Refer to the section "Options ● Optional regeneration unit" in this catalog for the tolerable regenerative power (W).
5. Servo amplifiers without an enclosed regenerative resistor are also available. Refer to "Servo Amplifier Model Designation" in this catalog for details.
6. The value in () is applicable when the external regenerative resistors, GRZG400-□Ω (standard accessory) are used with cooling fans (2 units of 92 X 92mm, minimum air flow: 1.0m³/min). Note that change in parameter No. PA02 is required.
7. 0.3A is the value when all of the input/output points are used. The current capacity can be stepped down according to the number of input/output points in use. Refer to "MR-J3-□A SERVO AMPLIFIER INSTRUCTION MANUAL" for details.
8. Special specification servo amplifiers without a dynamic brake are also available: MR-J3-□A4-ED. When using the servo amplifier without a dynamic brake, the servo motor does not stop immediately at alarm occurrence or power failure. Take measures to ensure safety on the entire system.
9. The servo amplifier built-in regenerative resistor is compatible with the maximum torque deceleration when the motor is used within the rated speed and the recommended load to motor inertia moment ratio. Contact your local sales office if the operating motor speed and the load to motor inertia moment ratio exceed the rated speed and the recommended ratio.
10. When using the built-in dynamic brake, refer to "MR-J3-□A SERVO AMPLIFIER INSTRUCTION MANUAL" for the permissible load to motor inertia moment ratio.
11. For the servo amplifier 11kW to 22kW, high resolution analog speed command and analog torque command is available with a set of MR-J3-□A4-RJ040 and MR-J3-D01 extension IO unit. Servo amplifier 7kW or smaller, compatible with high resolution analog speed torque command, will be available.
12. Use an optional external dynamic brake with the servo amplifier. Without the external dynamic brake, a servo motor does not stop immediately at emergency stop and falls in free-run status, causing an accident such as machine collision, etc. Take measures to ensure safety on the entire system.

Model designation

Servo motors

Servo amplifiers

Options

Peripheral equipment

MR-J3-B Safety

MR-J3W series

Servo support software

Cautions

Warranty

Global FA centers



MR-J3-A Servo Amplifier Specifications: 400VAC, 30kW or Larger

Drive unit model		MR-J3-DU30KA4	MR-J3-DU37KA4	MR-J3-DU45KA4	MR-J3-DU55KA4
Output	Rated voltage	3-phase 323VAC			
	Rated current (A)	87	102	131	143
Main circuit power supply		The drive unit's main circuit power is supplied from the converter unit.			
Control circuit power supply	Voltage/frequency	1-phase 380 to 480VAC 50/60Hz			
	Rated current (A)	0.2			
	Permissible voltage fluctuation	1-phase 323 to 528VAC			
	Permissible frequency fluctuation	±5% maximum			
	Power consumption (W)	45			
Interface power supply		24VDC ±10% (required current capacity: 0.3A (Note 3))			
Control system		Sine-wave PWM control/current control system			
Dynamic brake		External option (Note 4)			
Safety features		Overcurrent shutdown, overload shutdown (electronic thermal), servo motor overheat protection, encoder fault protection, undervoltage/sudden power outage protection, overspeed protection, excess error protection			
Position control mode	Maximum input pulse frequency	1Mpps (when using differential receiver), 200kpps (when using open collector)			
	Positioning feedback pulse	Encoder resolution: 262144 p/rev			
	Command pulse multiple	Electronic gear A/B multiple, A: 1 to 1048576, B: 1 to 1048576, 1/10 < A/B < 2000			
	Positioning complete width setting	0 to ±65535 pulses (command pulse unit)			
	Excess error	±3 rotations			
	Torque limit	Set by parameters or external analog input (0 to +10VDC/maximum torque)			
Speed control mode	Speed control range	Analog speed command 1:2000, internal speed command 1:5000			
	Analog speed command input	0 to ±10VDC/rated speed (possible to change the speed in 10V using parameter No. PC12.)			
	Speed fluctuation rate	±0.01% maximum (load fluctuation 0 to 100%), 0% (power fluctuation ±10%) ±0.2% maximum (ambient temperature 25°C±10°C (59°F to 95°F)), when using analog speed command			
	Torque limit	Set by parameters or external analog input (0 to +10VDC/maximum torque)			
Torque control mode	Analog torque command input	0 to ±8VDC/maximum torque (input impedance 10 to 12kΩ)			
	Speed limit	Set by parameters or external analog input (0 to ±10VDC/rated speed)			
Structure (IP rating)		Fan cooling open (IP00)			
Mass (kg [lb])		18 (40)		26 (57)	
Converter unit model		MR-J3-CR55K4			
Output	Rated voltage	538 to 678VDC			
	Rated current (A)	113.8			
Main circuit power supply	Voltage/frequency (Note 1, 2)	3-phase 380 to 480VAC 50/60Hz			
	Rated current (A)	132.2			
	Permissible voltage fluctuation	3-phase 323 to 528VAC			
	Permissible frequency fluctuation	±5% maximum			
Control circuit power supply	Voltage/frequency	1-phase 380 to 480VAC 50/60Hz			
	Rated current (A)	0.2			
	Permissible voltage fluctuation	1-phase 323 to 528VAC			
	Permissible frequency fluctuation	±5% maximum			
	Power consumption (W)	45			
Interface power supply		24VDC ±10% (required current capacity: 0.13A (Note 3))			
Safety features		Regeneration overvoltage shutdown, regeneration fault protection, overload shutdown (electronic thermal), undervoltage/sudden power outage protection			
Structure (IP rating)		Fan cooling open (IP00)			
Mass (kg [lb])		25 (55)			
Drive unit/ Converter unit	Environment	Ambient temperature	0 to 55°C (32 to 131°F) (non freezing), storage: -20 to 65°C (-4 to 149°F) (non freezing)		
		Ambient humidity	90% RH maximum (non condensing), storage: 90% RH maximum (non condensing)		
		Atmosphere	Indoors (no direct sunlight); no corrosive gas, inflammable gas, oil mist or dust		
		Elevation	1000m or less above sea level		
		Vibration	5.9m/s ² or less at 10 to 55Hz (directions of X, Y and Z axes)		

- Notes: 1. Rated output and speed of a servo motor are applicable when the drive unit and the converter unit, combined with the servo motor, are operated within the specified power supply voltage and frequency. Torque drops when the power supply voltage is below the specified value.
 2. For torque characteristics when combined with a servo motor, refer to the section "Servo motor torque characteristics" in this catalog.
 3. The interface power supply can be shared with the drive unit and the converter unit. When all of the input/output points are used, 0.3A is required for the drive unit, and 0.13A is required for the converter unit. The current capacity can be stepped down according to the number of input/output points in use. Refer to "MR-J3-□A SERVO AMPLIFIER INSTRUCTION MANUAL" for details.
 4. Use an optional external dynamic brake with the drive unit. Without the external dynamic brake, a servo motor does not stop immediately at emergency stop and falls in free-run status, causing an accident such as machine collision, etc. Take measures to ensure safety on the entire system.

MR-J3-□A□ Standard Wiring Diagram: Position Control Operation

● Connection example to QD75D (position servo, incremental)

Main circuit/control circuit power supply connection

The connection differs according to the power voltage.
→Refer to main/control circuit power supply connection examples (1) to (6).

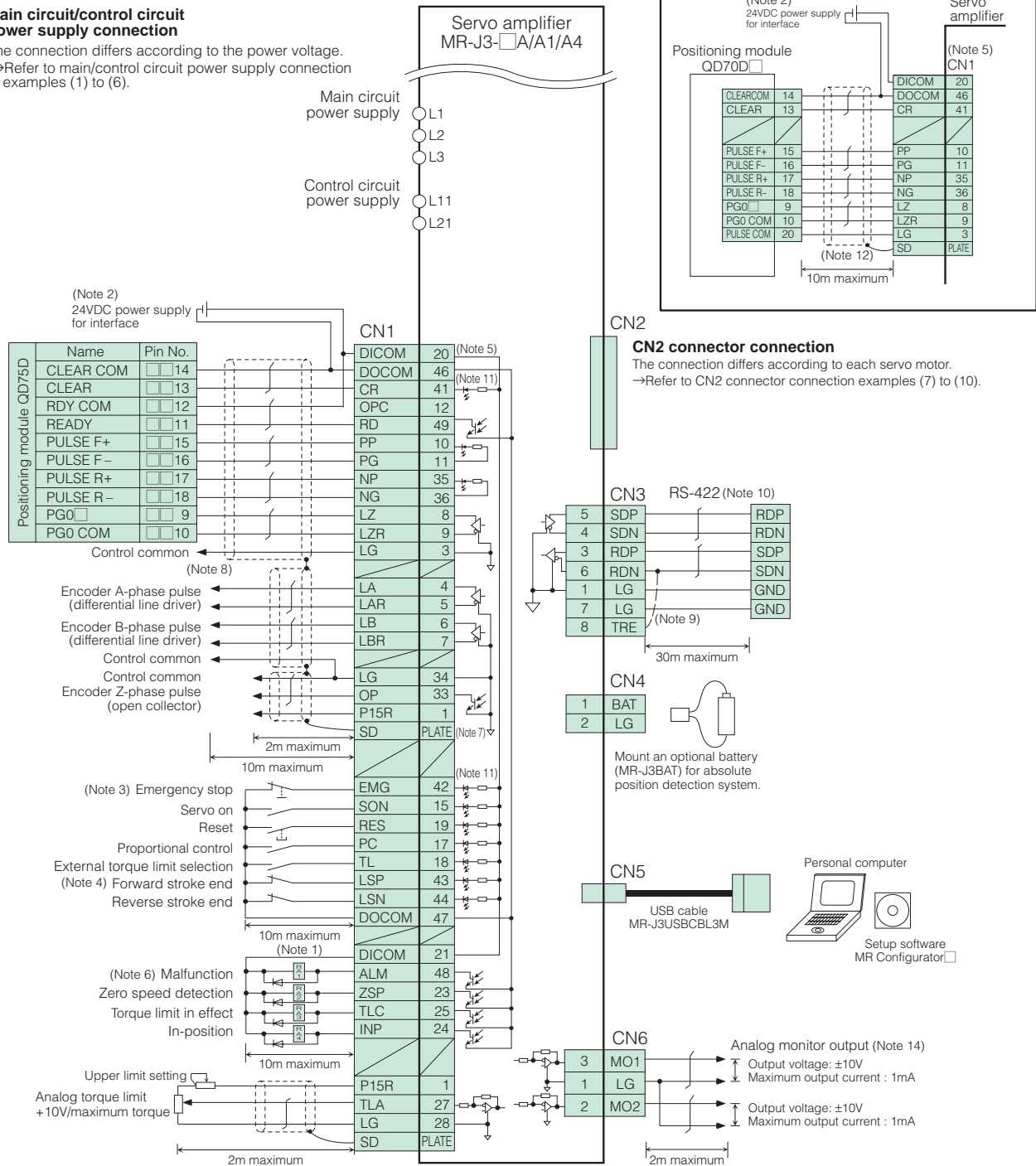

Notes:

- Do not reverse the diode's direction. Connecting it backwards may cause the servo amplifier to malfunction such that the signals are not output, and the emergency stop and other safety circuits are inoperable.
- Use the power supply 24VDC±10% (required current capacity: 0.3A). 0.3A is the value when all of the input/output points are used. Note that the current capacity can be stepped down according to the number of input/output points in use. Refer to "MR-J3-□A SERVO AMPLIFIER INSTRUCTION MANUAL" for details.
- Always turn on the emergency stop (EMG) signal (normally closed contact) before starting the operation. If not, the operation will not start.
- Always turn on the forward and reverse stroke end (LSP, LSN) signals (normally closed contact) before starting the operation. If not, the commands will not be accepted.
- Signals with the same name are connected internally.
- The malfunction (ALM) signal (normally closed contact) is conducted to DOCOM in normal alarm-free condition.
- Connect the shield wire securely to the plate inside the connector (ground plate).
- This connection is not necessary for QD75D positioning module. Note that the connection between LG and control common terminal is recommended for some positioning modules to improve noise immunity.
- For the final axis, connect TRE and RDN.
- A personal computer can be connected using a RS-422/RS-232C conversion cable. Note that USB interface (CN5 connector) and RS-422 interface (CN3 connector) are mutually exclusive. They cannot be used at the same time. Refer to the section "Ordering Information for Customers" in this catalog for the RS-422/RS-232C conversion cable.
- This is for sink wiring. Source wiring is also possible. Refer to "MR-J3-□A SERVO AMPLIFIER INSTRUCTION MANUAL" for details.
- FA goods (Model: FA-CBLQ75M2J3(-P)/-1(P)) cannot be used.
- Do not use CN2L connector.
- Output voltage range varies depending on the monitored signal.

Model designation
Servo motors
Servo amplifiers
Options
Peripheral equipment
MR-J3-B Safety series
MR-J3W series
Servo support software
Cautions
Warranty
Global FA centers

MR-J3-□A□ Standard Wiring Diagram: Speed Control Operation

● Connection example

Main circuit/control circuit power supply connection

The connection differs according to the power voltage.
→Refer to main/control circuit power supply connection examples (1) to (6).

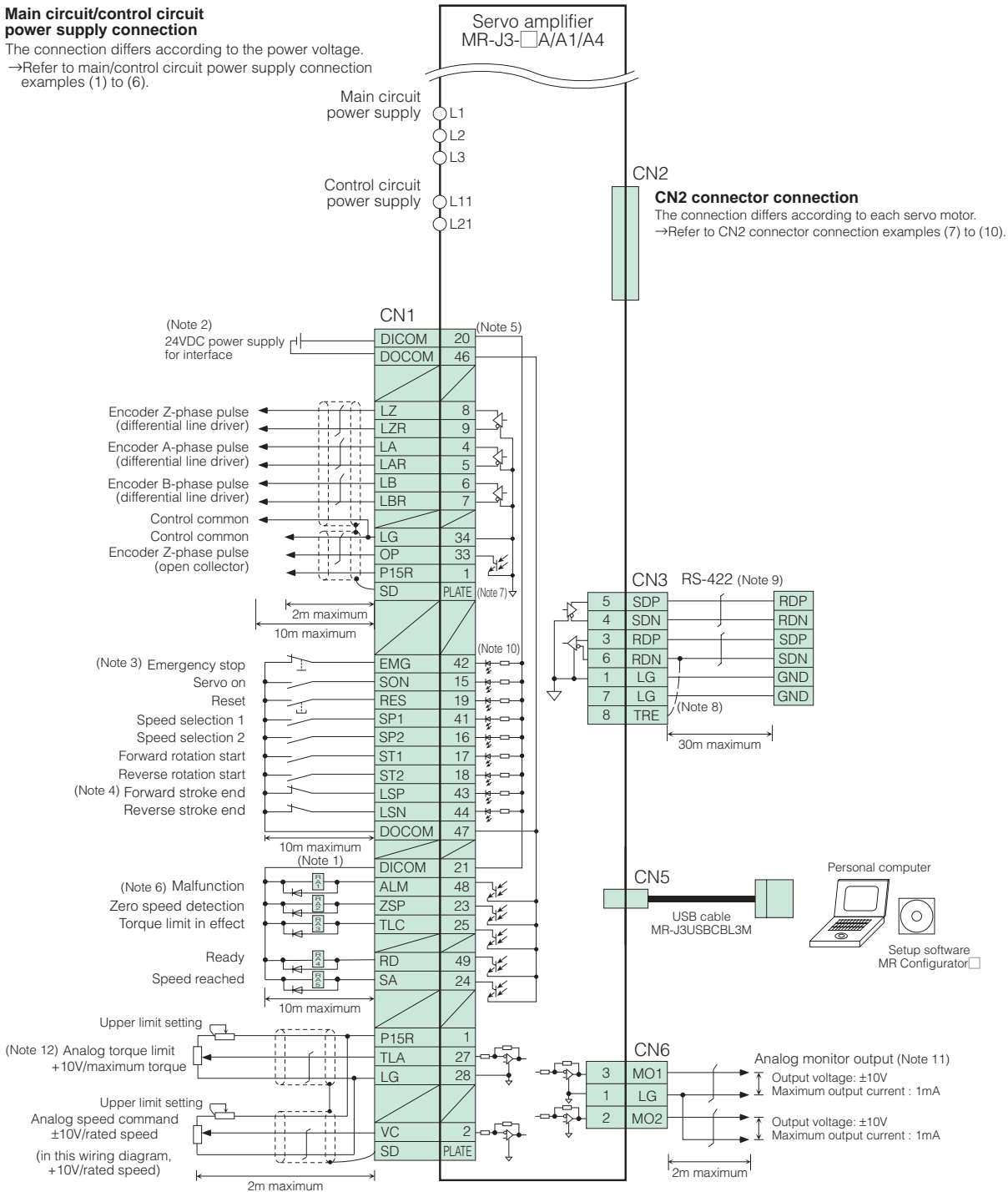

Notes:

- Do not reverse the diode's direction. Connecting it backwards may cause the servo amplifier to malfunction such that the signals are not output, and the emergency stop and other safety circuits are inoperable.
- Use the power supply $24VDC \pm 10\%$ (required current capacity: 0.3A). 0.3A is the value when all of the input/output points are used. Note that the current capacity can be stepped down according to the number of input/output points in use. Refer to "MR-J3-□A SERVO AMPLIFIER INSTRUCTION MANUAL" for details.
- Always turn on the emergency stop (EMG) signal (normally closed contact) before starting the operation. If not, the operation will not start.
- Always turn on the forward and reverse stroke end (LSP, LSN) signals (normally closed contact) before starting the operation. If not, the commands will not be accepted.
- Signals with the same name are connected internally.
- The malfunction (ALM) signal (normally closed contact) is conducted to DOCOM in normal alarm-free condition.
- Connect the shield wire securely to the plate inside the connector (ground plate).
- For the final axis, connect TRE and RDN.
- A personal computer can be connected using a RS-422/RS-232C conversion cable. Note that USB interface (CN5 connector) and RS-422 interface (CN3 connector) are mutually exclusive. They cannot be used at the same time. Refer to the section "Ordering Information for Customers" in this catalog for the RS-422/RS-232C conversion cable.
- This is for sink wiring. Source wiring is also possible. Refer to "MR-J3-□A SERVO AMPLIFIER INSTRUCTION MANUAL" for details.
- Output voltage range varies depending on the monitored signal.
- TLA can be used when external torque limit (TL) is enabled by setting parameters.

MR-J3-□A□ Standard Wiring Diagram: Torque Control Operation

● Connection example

Main circuit/control circuit power supply connection

The connection differs according to the power voltage.
 →Refer to main/control circuit power supply connection examples (1) to (6).

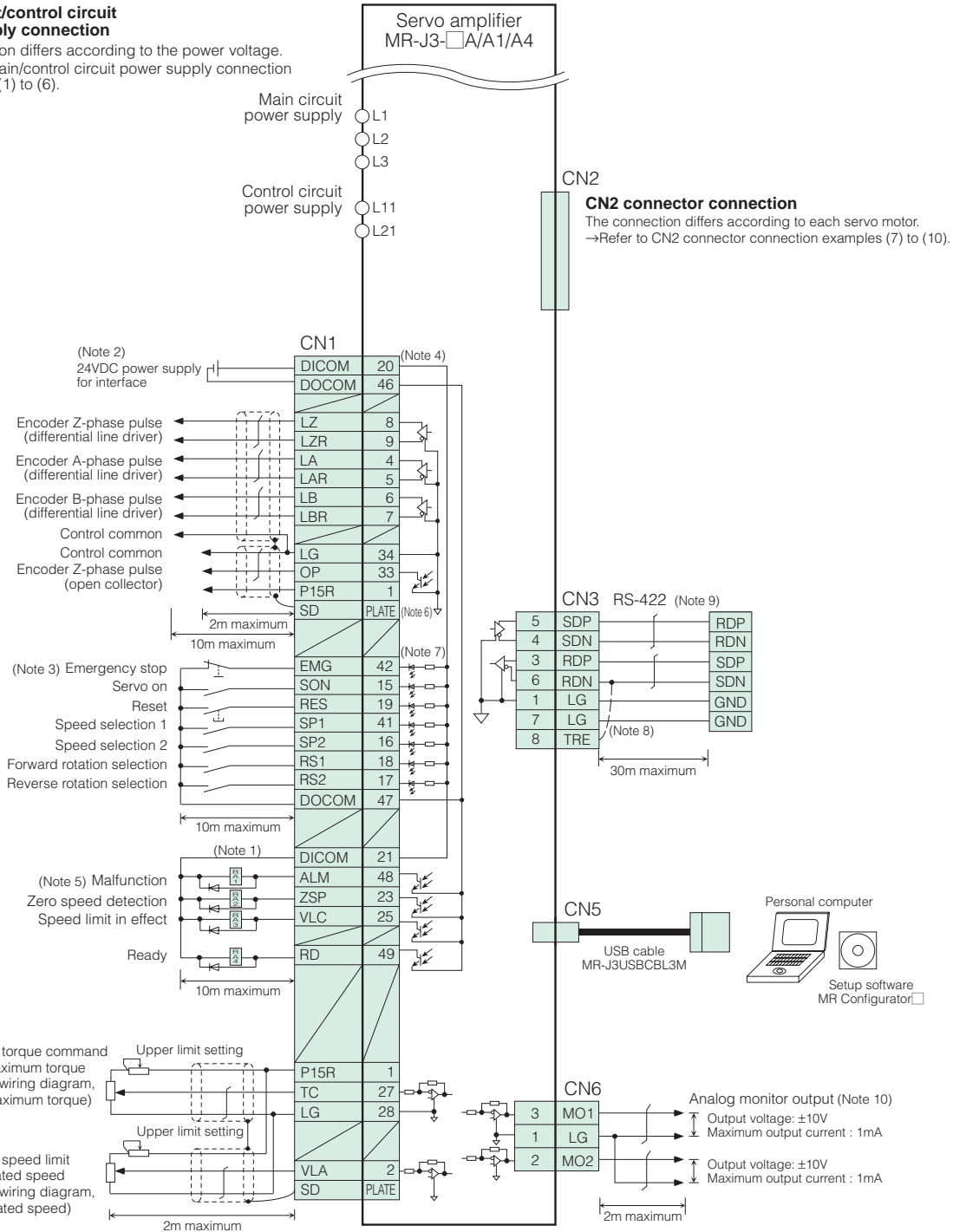

Notes:

- Do not reverse the diode's direction. Connecting it backwards may cause the servo amplifier to malfunction such that the signals are not output, and the emergency stop and other safety circuits are inoperable.
- Use the power supply 24VDC±10% (required current capacity: 0.3A). 0.3A is the value when all of the input/output points are used. Note that the current capacity can be stepped down according to the number of input/output points in use. Refer to "MR-J3-□A SERVO AMPLIFIER INSTRUCTION MANUAL" for details.
- Always turn on the emergency stop (EMG) signal (normally closed contact) before starting the operation. If not, the operation will not start.
- Signals with the same name are connected internally.
- The malfunction (ALM) signal (normally closed contact) is conducted to Docom in normal alarm-free condition.
- Connect the shield wire securely to the plate inside the connector (ground plate).
- This is for sink wiring. Source wiring is also possible. Refer to "MR-J3-□A SERVO AMPLIFIER INSTRUCTION MANUAL" for details.
- For the final axis, connect TRE and RDN.
- A personal computer can be connected using an RS-422/RS-232C conversion cable. Note that USB interface (CN5 connector) and RS-422 interface (CN3 connector) are mutually exclusive. They cannot be used at the same time. Refer to the section "Ordering Information for Customers" in this catalog for the RS-422/RS-232C conversion cable.
- Output voltage range varies depending on the monitored signal.

Model designation
 Servo motors
 Servo amplifiers
 Options
 Peripheral equipment
 MR-J3-B Safety
 MR-J3W series
 Servo support software
 Cautions
 Warranty
 Global FA centers

Main/Control Circuit Power Supply Connection Examples

(1) 1-phase 100V

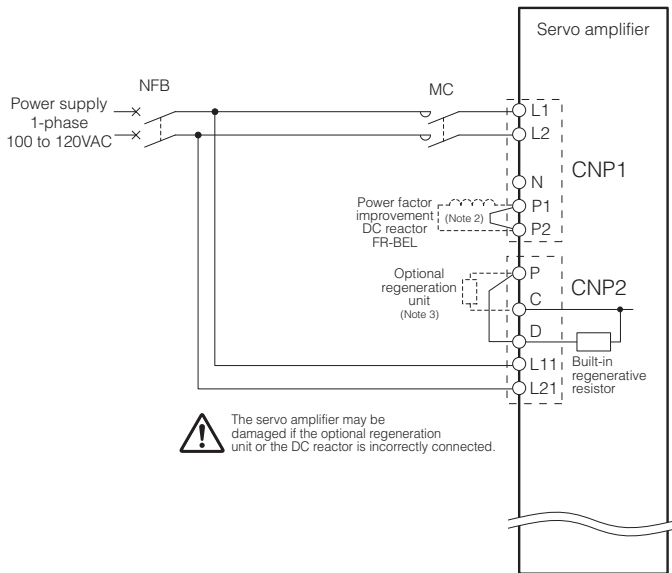

(2) 1-phase 200V

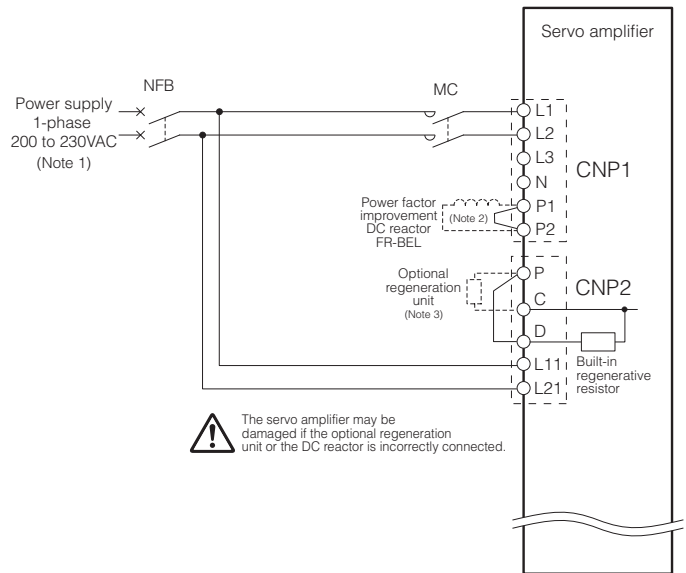

(3) 3-phase 200V 0.1kW to 3.5kW
or 3-phase 400V 0.6kW to 2kW

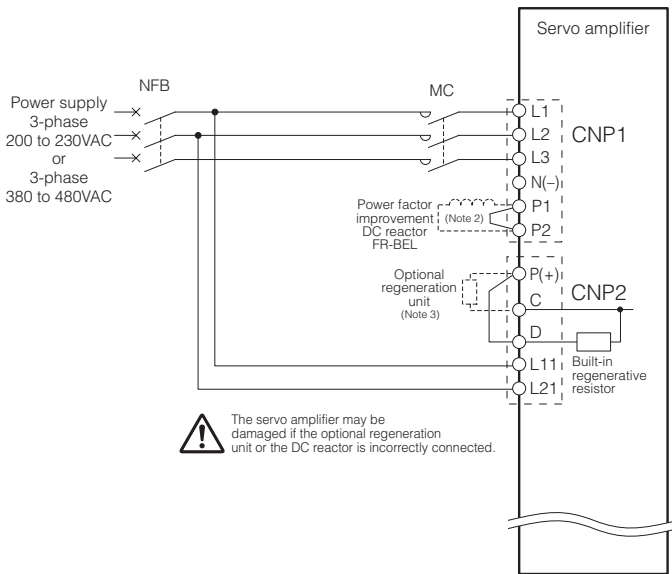

(4) 3-phase 200V 5kW or 7kW,
or 3-phase 400V 3.5kW to 7kW

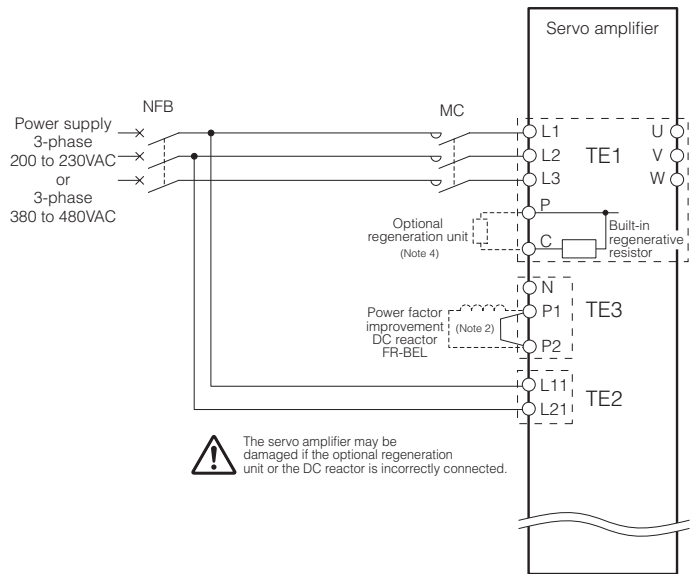

Notes:

1. When using a 1-phase 200VAC to 230VAC, connect the power supply to the L1 and L2 terminals. Do not connect anything to L3.
2. Disconnect P1 and P2 when using the DC reactor.
3. Disconnect P(+) and D when connecting the optional regeneration unit externally.
4. Disconnect the wires for the built-in regenerative resistor (P and C) when connecting the optional regeneration unit externally.

(5) 3-phase 200V/400V 11kW to 22kW

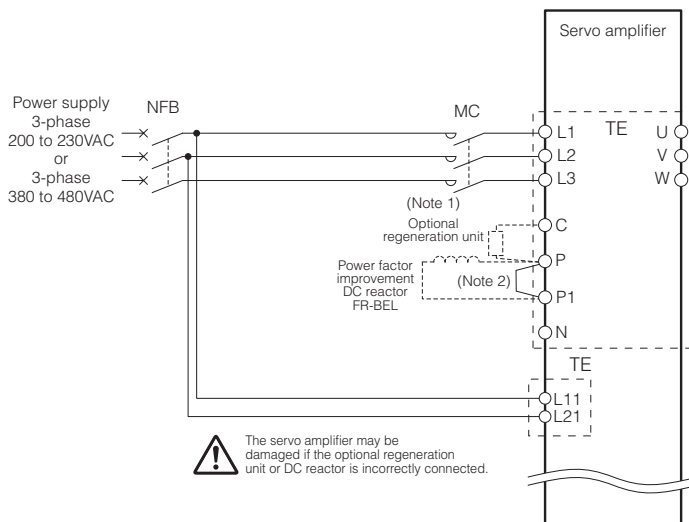

(6) 3-phase 200V/400V 30kW or larger (Note 3)

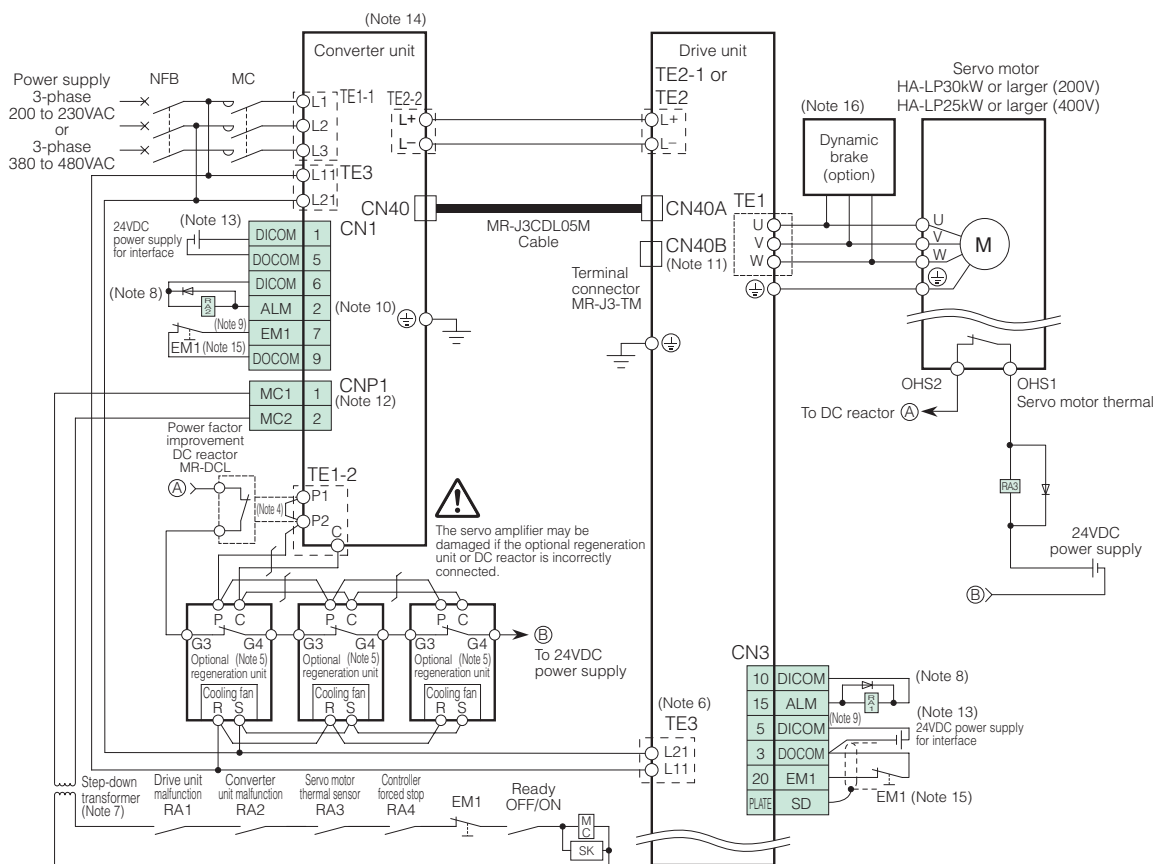

Notes:

- 11kW or larger servo amplifiers do not have a built-in regenerative resistor.
- Remove the short bar between P and P1 when using the DC reactor.
- This wiring diagram is for MR-J3-DU□□A(4). For MR-J3-DU□□A(4), refer to "MR-J3-□A SERVO AMPLIFIER INSTRUCTION MANUAL".
- Remove the short bar between P1 and P2 when using the DC reactor.
- This is for MR-RB137 (for 200V) or MR-RB138-4 (for 400V). Three units of MR-RB137 or MR-RB138-4 are required for each converter unit (tolerable regenerative power 3900W).
- The phases of the power supply connected to L1 and L21 on the converter unit and the drive unit must always match the phases connected to L1 and L2. An incorrect connection may damage the drive unit and/or the converter unit.
- A step-down transformer is required when coil voltage of the magnetic contactor (MC) is 200V class, and the converter unit and the drive unit are 400V class.
- Do not reverse the diode's direction. Connecting it backwards may cause the drive unit and/or the converter unit to malfunction such that the signals are not output, and the emergency stop and other safety circuits are inoperable.
- Select a device that does not make the circuit current exceed 40mA.
- The malfunction (ALM) signal (normally closed contact) is conducted to DCOM in normal alarm-free condition.
- Always connect the terminal connector (MR-J3-TM) to CN40B.
- MC1 and MC2 outputs are controlled by the converter unit. For creating a system same as that of the prior servo amplifier by invalidating CNP1, refer to "MR-J3 SERVO AMPLIFIER INSTRUCTION MANUAL" for details.
- The interface power supply can be shared with the drive unit and the converter unit. When all of the input/output points are used, 0.15A is required for the drive unit and 0.13A for the converter unit. The current capacity can be stepped down according to the number of input/output points in use.
- A converter unit is required per drive unit.
- Create a circuit that shuts off the forced stop (EM1) of the converter unit and the drive unit at the same time.
- Use an optional external dynamic brake with the drive unit. Without the external dynamic brake, a servo motor does not stop immediately at emergency stop and falls in free-run status, causing an accident such as machine collision, etc. Take measures to ensure safety on the entire system.

CN2 Connector Connection Examples

(7) HF-KP/HF-MP series

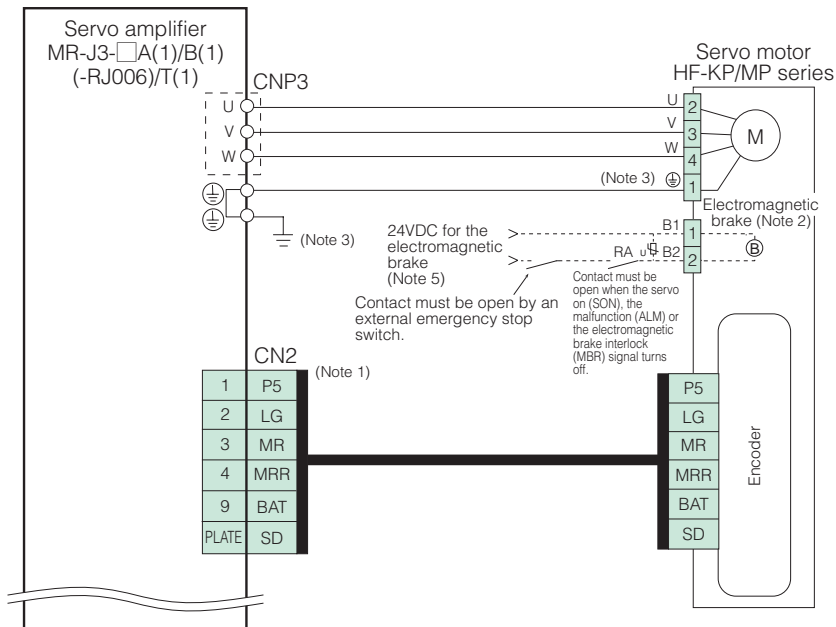

(8) HF-SP/HF-JP series

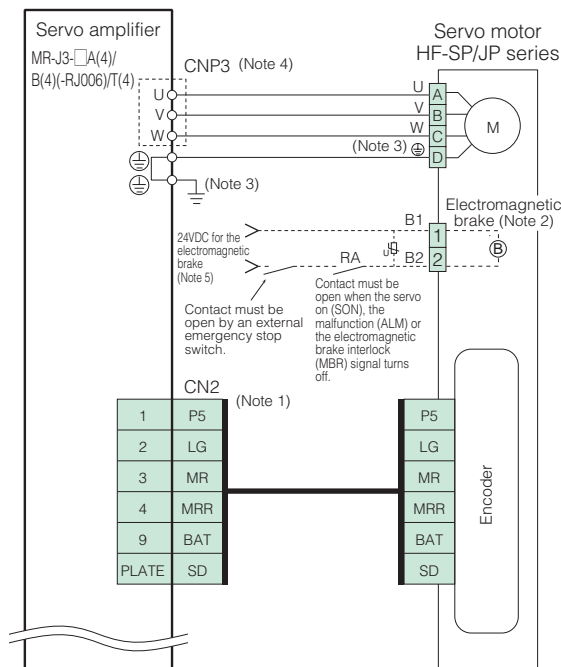

(9) HC-LP/HC-RP/HC-UP series or HA-LP502/702

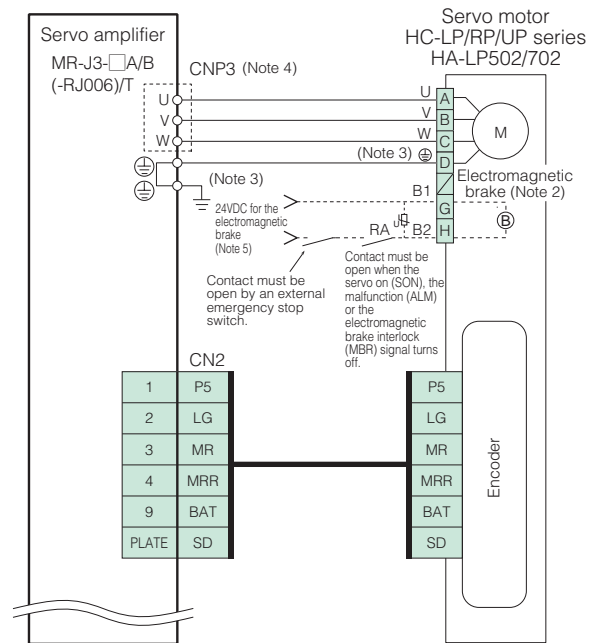

Notes:

1. The signals shown is applicable when using a two-wire type encoder cable. When using a four-wire type encoder cable for HF-KP/HF-MP series or 11kW and 15kW of HF-JP series, refer to "MR-J3 SERVO AMPLIFIER INSTRUCTION MANUAL" for details.
2. This is for the motor with an electromagnetic brake. The electromagnetic brake terminals (B1, B2) do not have polarity. A separate connector from the motor power supply connector is prepared as an electromagnetic brake connector for HC-LP202B, 302B, and HC-UP202B to 502B.
3. Connect the ground wire to the cabinet protective earth (PE) terminal via the servo amplifier protective earth (PE) terminal for grounding.
4. U, V and W terminals are available in TE1 for 200V 5kW or larger and 400V 3.5kW or larger servo amplifiers.
5. Do not use the 24VDC interface power supply for the electromagnetic brake. Provide a power supply designed exclusively for the electromagnetic brake.

(10) HA-LP601(4)/701M(4)/801(4) or HA-LP series 11kW or larger

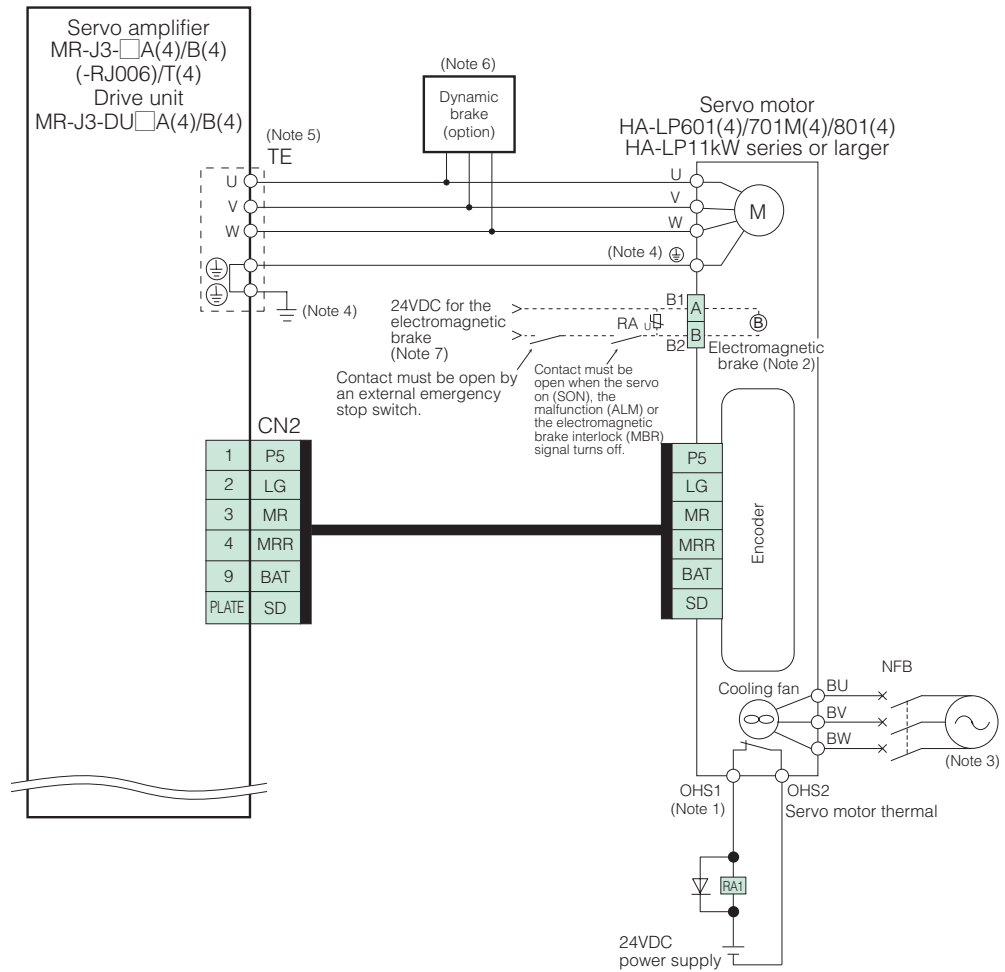

Notes:

1. Make sure that the current flowing to the servo motor thermal circuit is between 0.15A and 3A.
2. The electromagnetic brake terminals (B1, B2) do not have polarity.
3. Always supply power to the cooling fan terminal. The power supply differs according to the motor. Refer to "Cooling fan power supply" under the Motor Specifications in this catalog.
4. When using the servo amplifier 22kW or smaller, connect the ground wire to the cabinet protective earth (PE) terminal via the servo amplifier protective earth (PE) terminal for grounding. When using the drive unit, connect the servo motor's ground wire to the drive unit protective earth (PE) terminal, and then connect to ground.
5. U, V and W terminals are available in TE1 for HA-LP601(4) and HA-LP701M(4).
6. Use an optional external dynamic brake with the 11kW or larger servo amplifier. Without the external dynamic brake, a servo motor does not stop immediately at emergency stop and falls in free-run status, causing an accident such as machine collision, etc. Take measures to ensure safety on the entire system.
7. Do not use the 24VDC interface power supply for the electromagnetic brake. Provide a power supply designed exclusively for the electromagnetic brake.

MELSERVO-J3

MR-J3-□A□ Servo Amplifier Dimensions

(Unit: mm)

● MR-J3-10A, 20A, 10A1, 20A1 (Note 1)

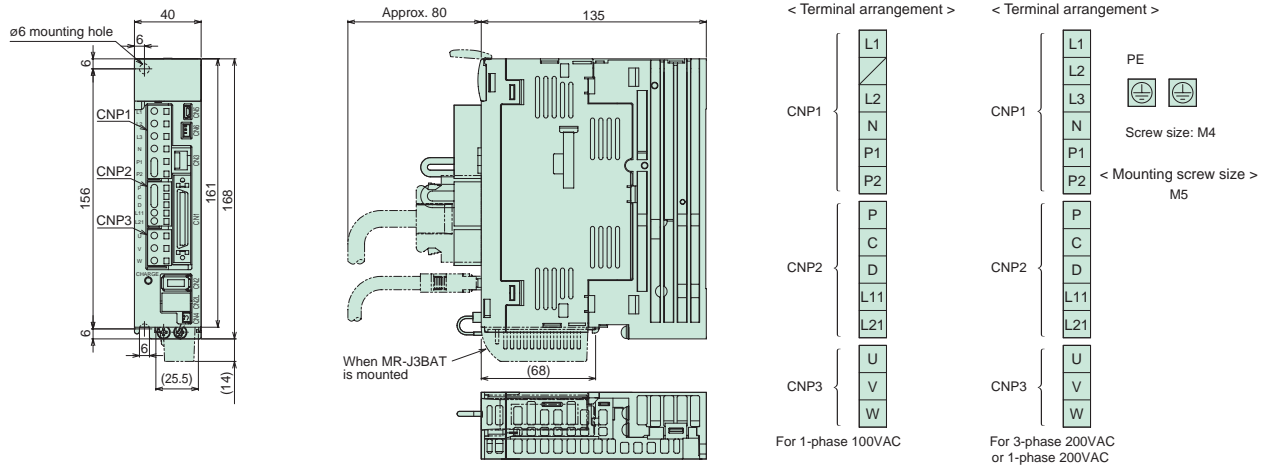

● MR-J3-40A, 60A, 40A1 (Note 1)

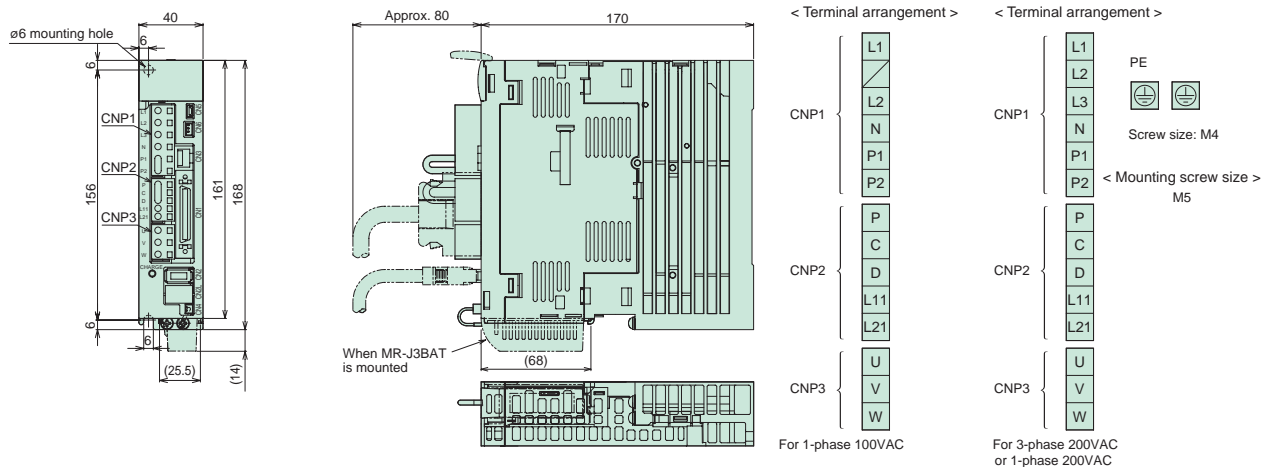

● MR-J3-70A, 100A (Note 1)

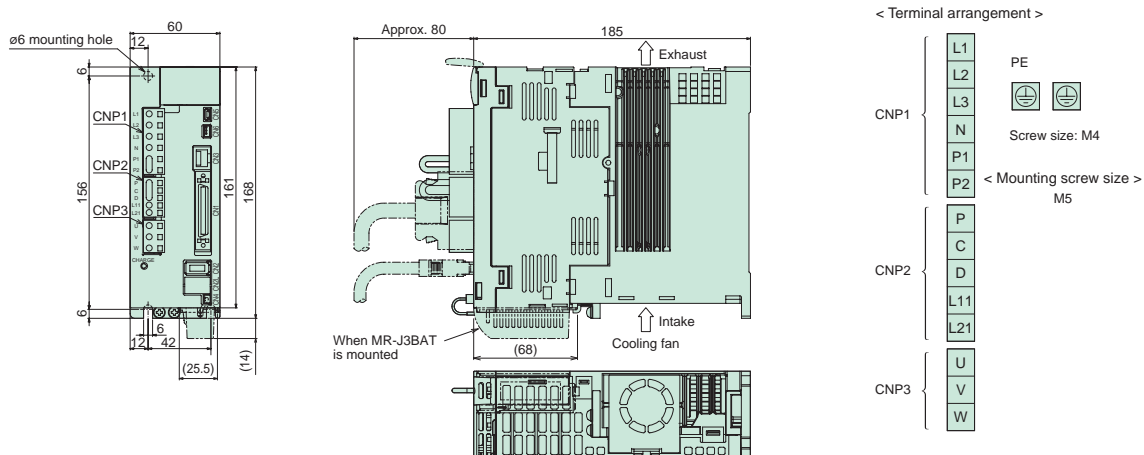

Notes: 1. CNP1, CNP2 and CNP3 connectors (insertion type) are supplied with the servo amplifier.

● MR-J3-60A4, 100A4 (Note 1)

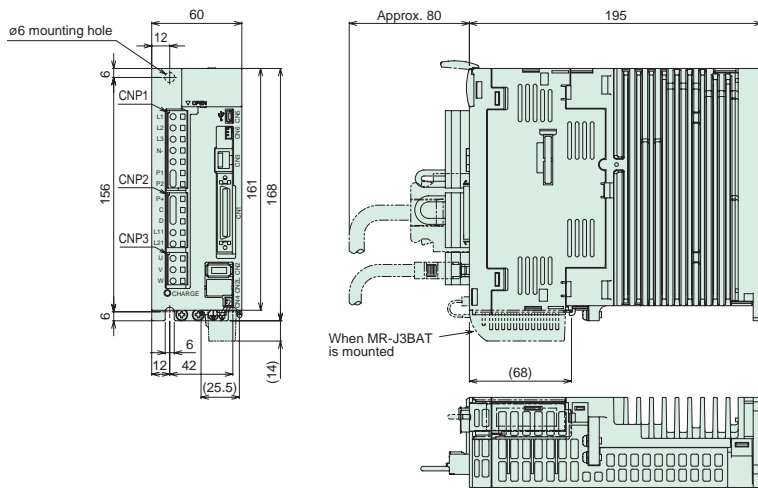

< Terminal arrangement >

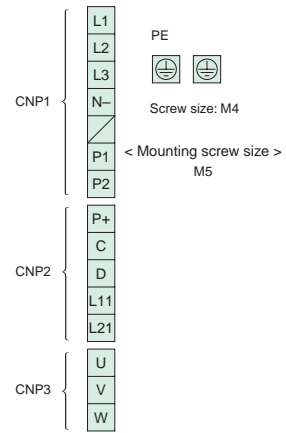

● MR-J3-200AN*, 200A4 (Note 1)

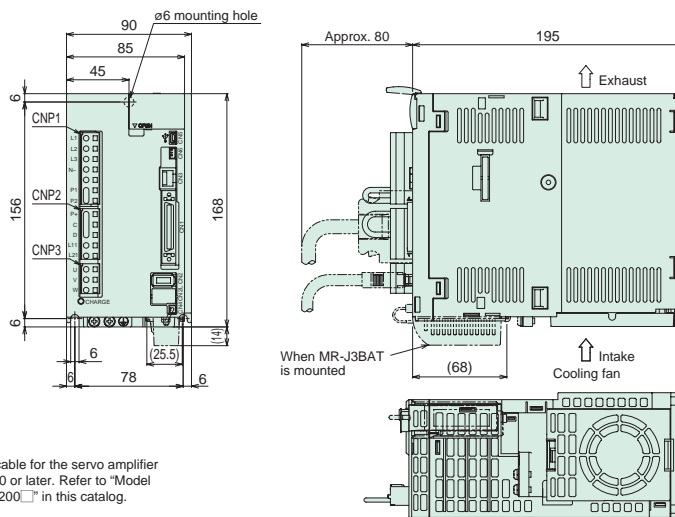

< Terminal arrangement >

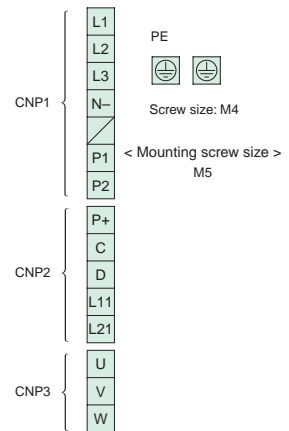

* The dimensions are applicable for the servo amplifier manufactured on July 2010 or later. Refer to "Model Name Change for MR-J3-200□" in this catalog.

● MR-J3-350A (Note 1)

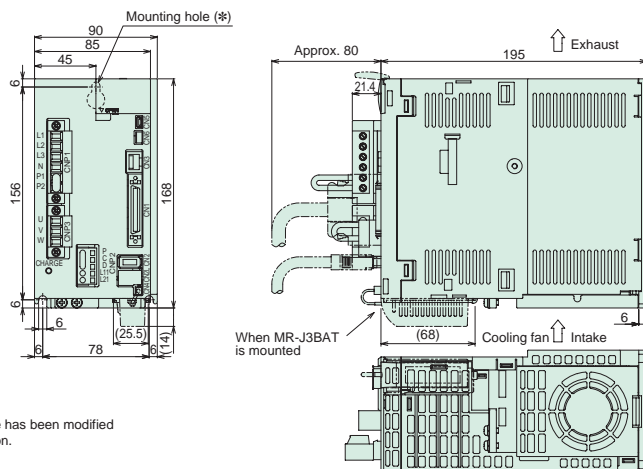

< Terminal arrangement >

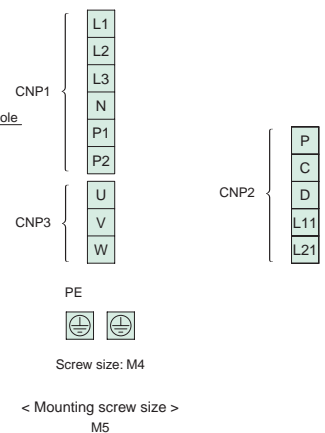

* The shape of the mounting hole has been modified from September 2010 production.

Notes: 1. CNP1, CNP2 and CNP3 connectors (insertion type) are supplied with the servo amplifier.

MELSERVO-J3

MR-J3-□A□ Servo Amplifier Dimensions

(Unit: mm)

● MR-J3-500A, 350A4, 500A4

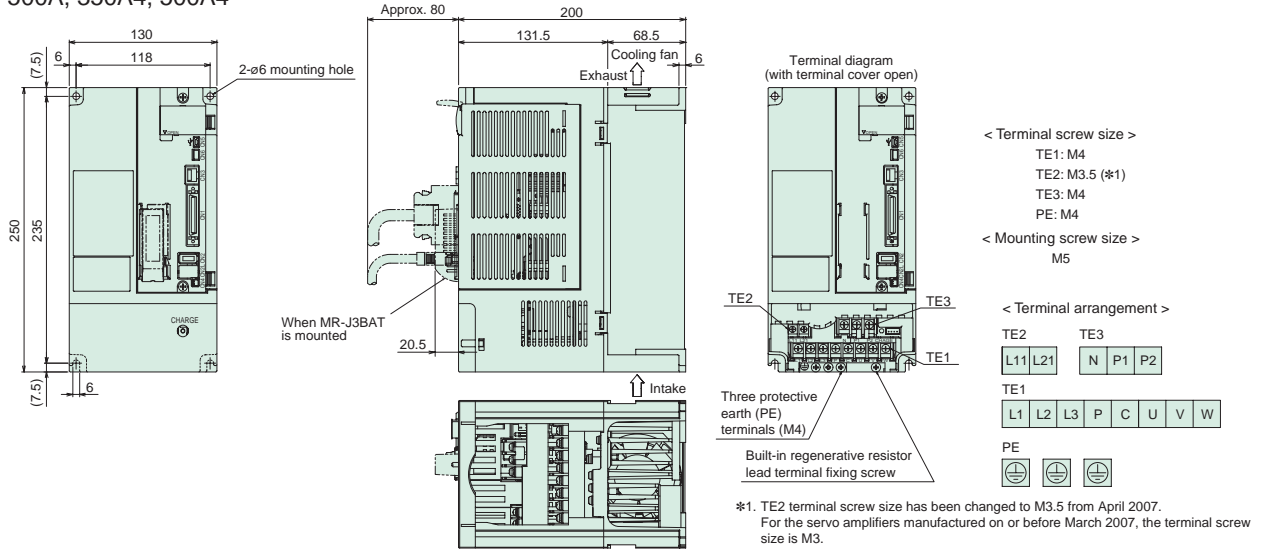

● MR-J3-700A, 700A4

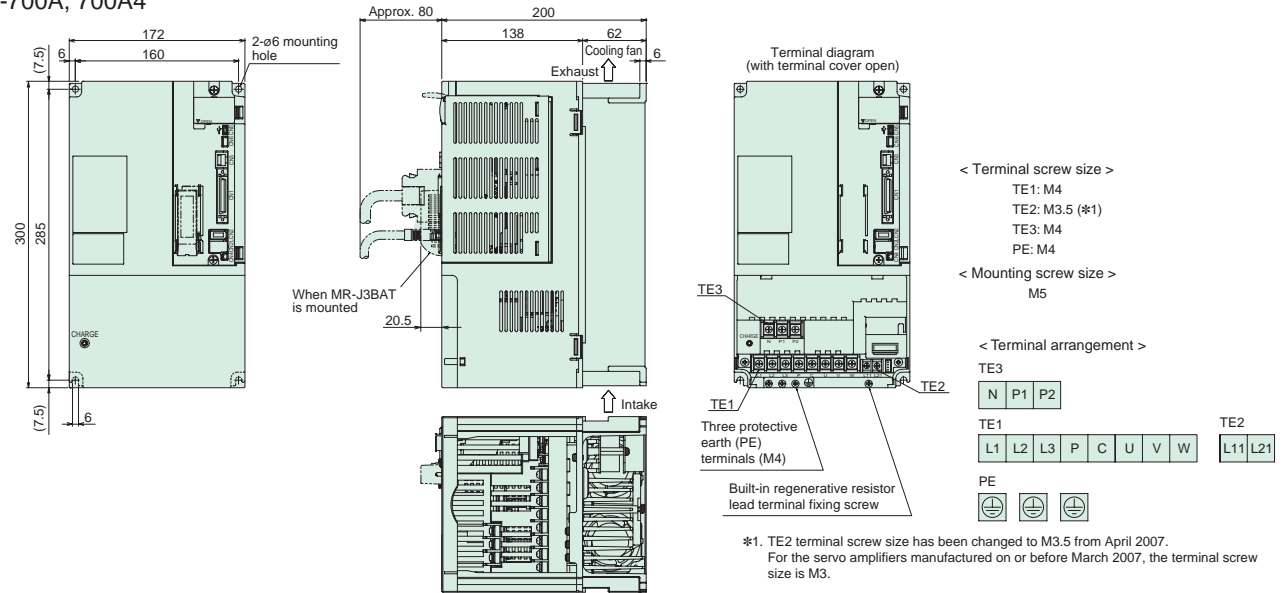

● MR-J3-11KA to 22KA, 11KA4 to 22KA4

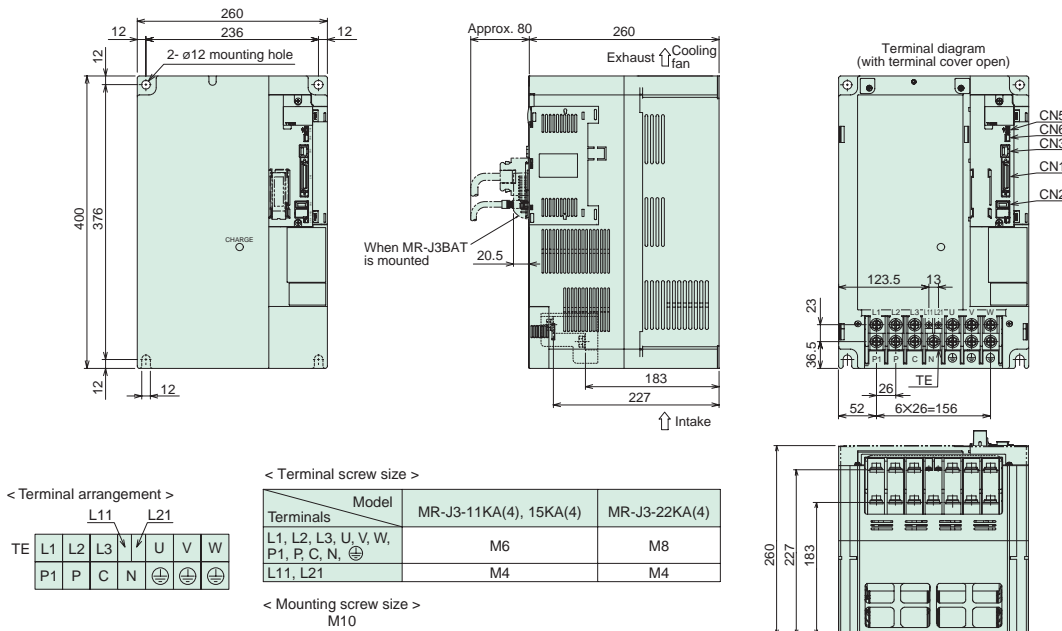

MR-J3-DU□A(4) Drive Unit Dimensions

(Unit: mm)

● MR-J3-DU30KA, DU37KA, DU45KA4, DU55KA4

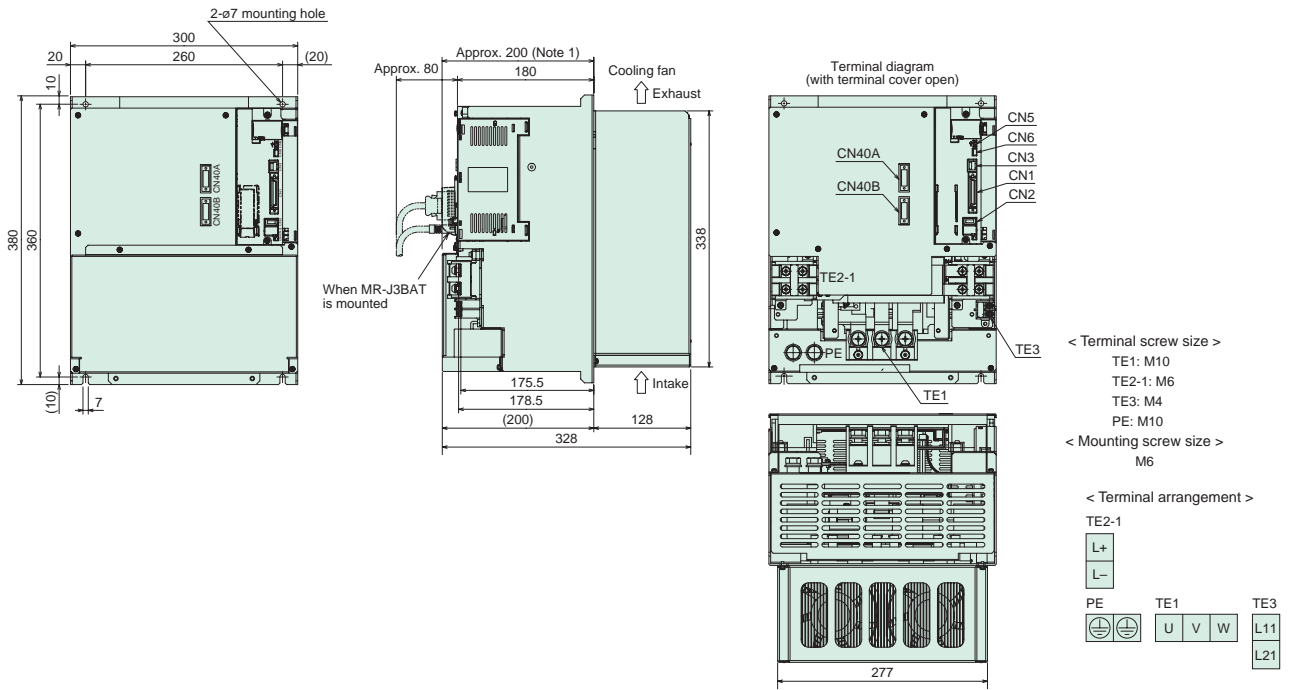

● MR-J3-DU30KA4, DU37KA4

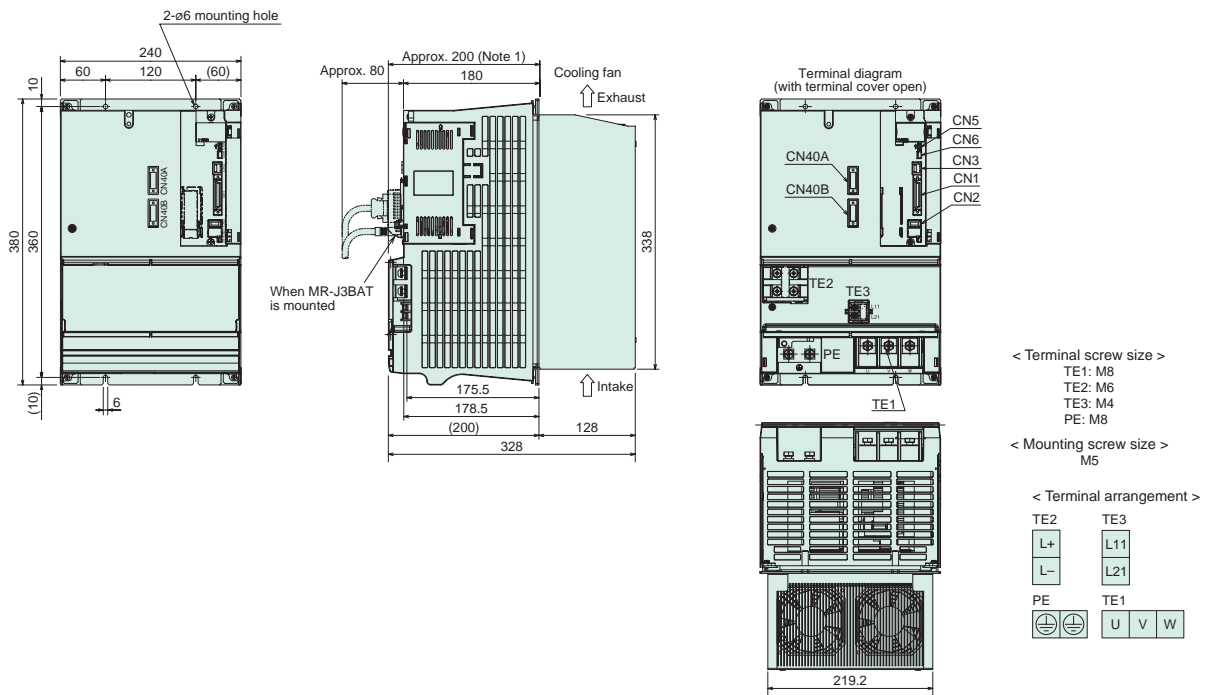

Notes: 1. The dimension is applicable when MR-J3BAT is mounted.

MELSERVO-J3

MR-J3-CR55K(4) Converter Unit Dimensions

(Unit: mm)

- MR-J3-CR55K, CR55K4 (Note 1)

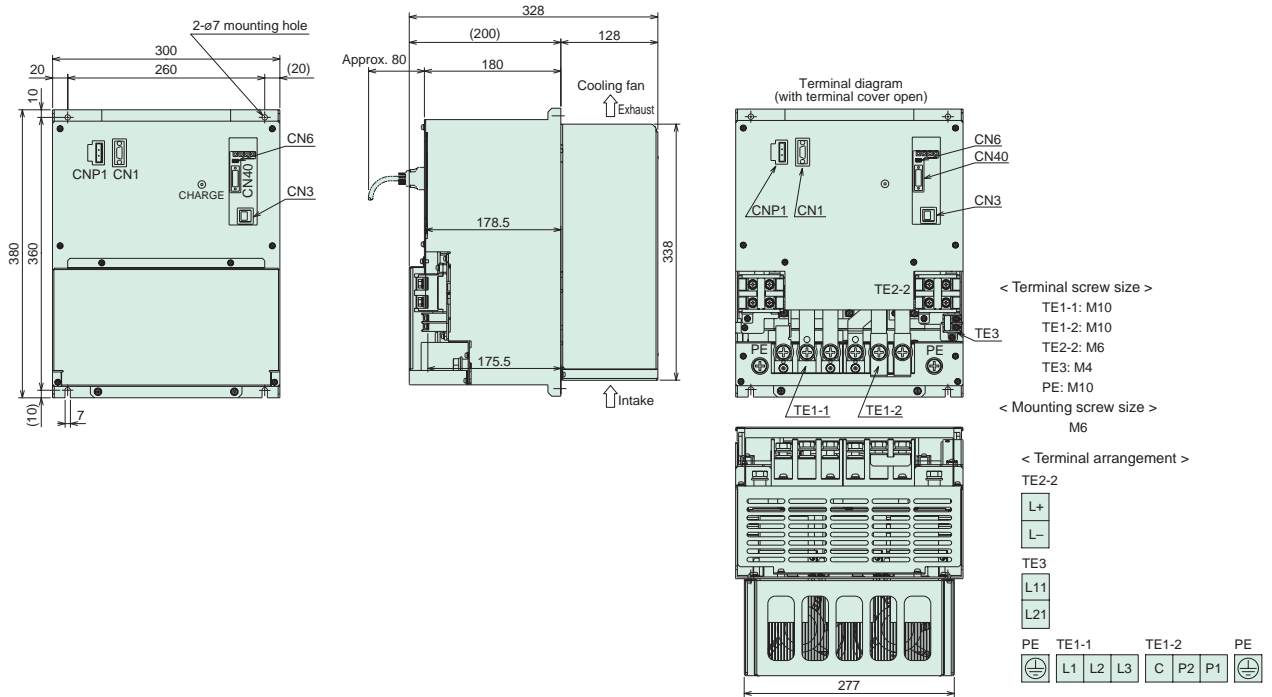

- Panel-cut dimensions for converter unit and drive unit (Note 1)

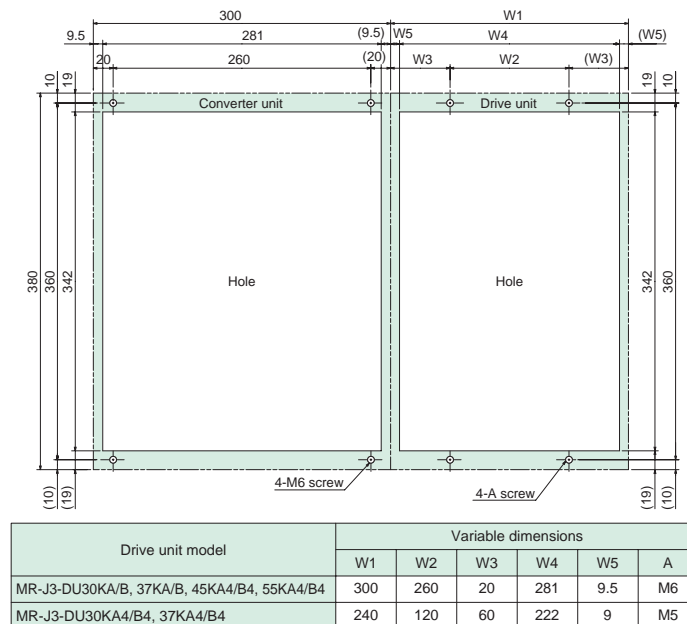

Notes: 1. The converter unit dimensions and the panel-cut dimensions for converter unit and drive unit are same for MR-J3-DU□A(4) and MR-J3-DU□B(4).

MR-J3-B: Connections with Peripheral Equipment (Note 1)

Peripheral equipment is connected to MR-J3-B as described below.

Connectors, cables, options, and other necessary equipment are available so that users can set up MR-J3-B easily and start using it right away. Due to the SSCNET III-compatible simple connections, the MR-J3-B reduces wiring and prevents wiring errors.

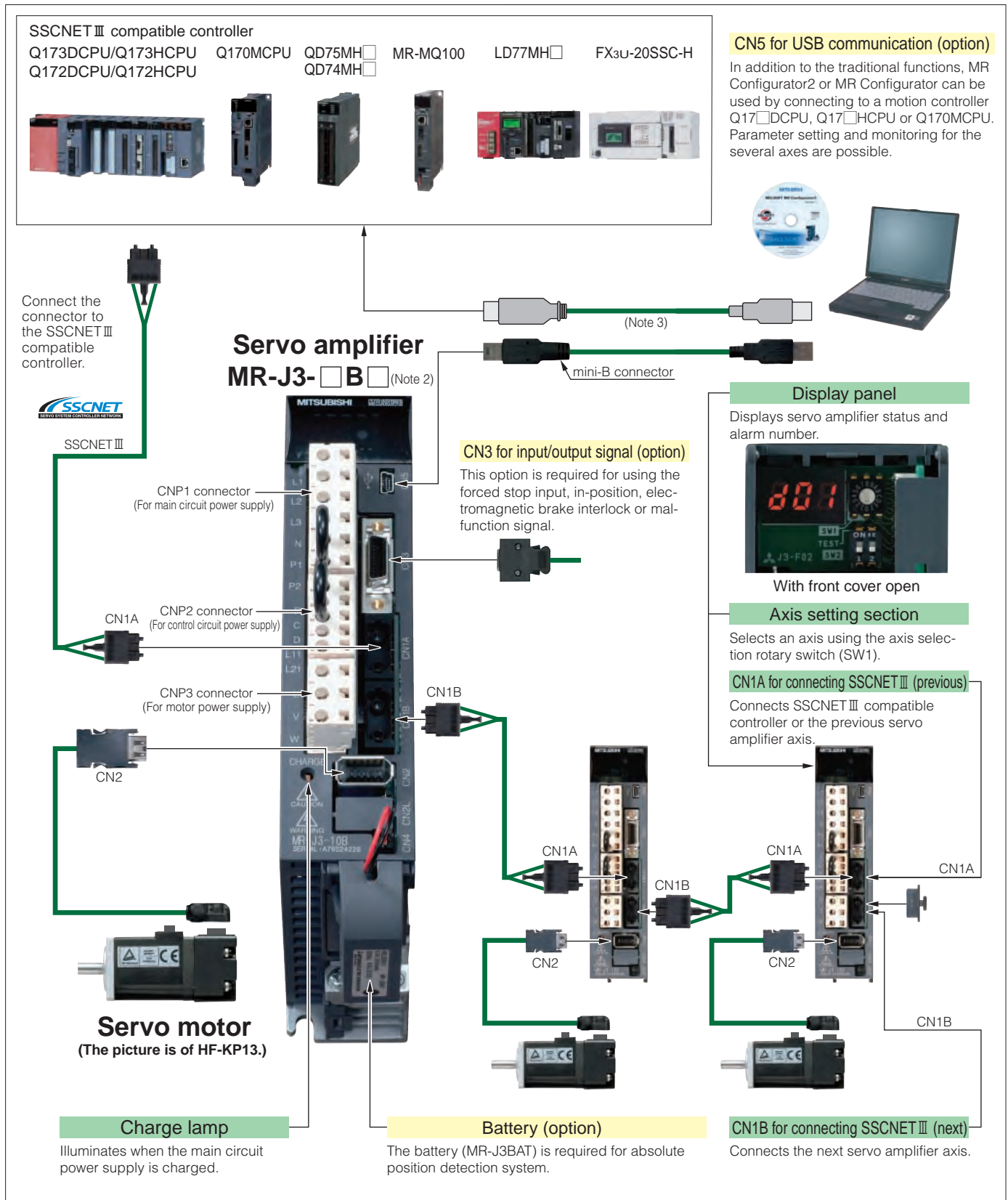



MR-J3-B Servo Amplifier Specifications: 100VAC/200VAC, 22kW or Smaller

Servo amplifier model MR-J3-		10B	20B	40B	60B	70B	100B	200B	350B	500B	700B	11KB	15KB	22KB	10B1	20B1	40B1
Output	Rated voltage	3-phase 170VAC															
	Rated current (A)	1.1	1.5	2.8	3.2	5.8	6.0	11.0	17.0	28.0	37.0	68.0	87.0	126.0	1.1	1.5	2.8
Main circuit power supply	Voltage/frequency (Note 1, 2)	3-phase 200 to 230VAC 50/60Hz or 1-phase 200 to 230VAC 50/60Hz (Note 10)					3-phase 200 to 230VAC 50/60Hz								1-phase 100 to 120VAC 50/60Hz		
	Rated current (A)	0.9	1.5	2.6	3.2	3.8	5.0	10.5	16.0	21.7	28.9	46.0	64.0	95.0	3.0	5.0	9.0
	Permissible voltage fluctuation	For 3-phase 200 to 230VAC: 3-phase 170 to 253VAC For 1-phase 200 to 230VAC: 1-phase 170 to 253VAC (Note 10)					3-phase 170 to 253VAC								1-phase 85 to 132VAC		
	Permissible frequency fluctuation	±5% maximum															
Control circuit power supply	Voltage/frequency	1-phase 200 to 230VAC 50/60Hz (Note 10)					1-phase 200 to 230VAC 50/60Hz								1-phase 100 to 120VAC 50/60Hz		
	Rated current (A)	0.2					0.3					0.4					
	Permissible voltage fluctuation	1-phase 170 to 253VAC (Note 10)					1-phase 170 to 253VAC								1-phase 85 to 132VAC		
	Permissible frequency fluctuation	±5% maximum															
	Power consumption (W)	30					45					30					
Interface power supply		24VDC ±10% (required current capacity: 0.15A (Note 7))															
Tolerable regenerative power of regenerative resistor (W) (Note 3, 4)	Built-in regenerative resistor	—	10	10	10	20	20	100	100	130	170	—	—	—	—	10	10
	External regenerative resistor (Standard accessory) (Note 5, 6)	—	—	—	—	—	—	—	—	—	—	500 (800)	850 (1300)	850 (1300)	—	—	—
Control system		Sine-wave PWM control/current control system															
Dynamic brake		Built-in (Note 8, 11)										External option (Note 12)			Built-in (Note 8, 11)		
Safety features		Overcurrent shutdown, regeneration overvoltage shutdown, overload shutdown (electronic thermal), servo motor overheat protection, encoder fault protection, regeneration fault protection, undervoltage/sudden power outage protection, overspeed protection, excess error protection															
Structure (IP rating)		Natural-cooling open (IP00)					Fan cooling open (IP00)								Natural-cooling open (IP00)		
Environment	Ambient temperature (Note 9)	0 to 55°C (32 to 131°F) (non freezing), storage: -20 to 65°C (-4 to 149°F) (non freezing)															
	Ambient humidity	90% RH maximum (non condensing), storage: 90% RH maximum (non condensing)															
	Atmosphere	Indoors (no direct sunlight); no corrosive gas, inflammable gas, oil mist or dust															
	Elevation	1000m or less above sea level															
	Vibration	5.9m/s ² or less at 10 to 55Hz (directions of X, Y and Z axes)															
Mass (kg [lb])		0.8 (1.8)	0.8 (1.8)	1.0 (2.2)	1.0 (2.2)	1.4 (3.1)	1.4 (3.1)	2.1 (4.6)	2.3 (5.1)	4.6 (10)	6.2 (14)	18 (40)	18 (40)	19 (42)	0.8 (1.8)	0.8 (1.8)	1.0 (2.2)

- Notes: 1. Rated output and speed of a servo motor are applicable when the servo amplifier, combined with the servo motor, is operated within the specified power supply voltage and frequency. Torque drops when the power supply voltage is below the specified value.
2. For torque characteristics when combined with a servo motor, refer to the section "Servo motor torque characteristics" in this catalog.
3. Optimal regenerative resistor varies for each system. Select the most suitable regenerative resistor by using the capacity selection software.
4. Refer to the section "Options ●Optional regeneration unit" in this catalog for the tolerable regenerative power (W).
5. Servo amplifiers without an enclosed regenerative resistor are also available. Refer to "Servo Amplifier Model Designation" in this catalog for details.
6. The value in () is applicable when the external regenerative resistors, GRZG400-□Ω (standard accessory) are used with cooling fans (2 units of 92 X 92mm, minimum air flow: 1.0m³/min). Note that change in parameter No. PA02 is required.
7. 0.15A is the value when all of the input/output points are used. The current capacity can be stepped down according to the number of input/output points in use. Refer to "MR-J3-□B SERVO AMPLIFIER INSTRUCTION MANUAL" for details.
8. Special specification servo amplifiers without a dynamic brake are also available: MR-J3-□B(1)-ED. When using the servo amplifier without a dynamic brake, the servo motor does not stop immediately at alarm occurrence or power failure. Take measures to ensure safety on the entire system.
9. MR-J3-350B or smaller servo amplifiers can be mounted closely. In this case, operate them at the ambient temperature of 0 to 45°C (32 to 113°F) or at 75% or less of the effective load ratio.
10. Special specification servo amplifiers for 1-phase 200 to 240VAC are also available: MR-J3-□B-U004. The permissible voltage fluctuation for MR-J3-□B-U004 is 1-phase 170 to 264VAC.
11. When using the built-in dynamic brake, refer to "MR-J3-□B SERVO AMPLIFIER INSTRUCTION MANUAL" for the permissible load to motor inertia moment ratio.
12. Use an optional external dynamic brake with the servo amplifier. Without the external dynamic brake, a servo motor does not stop immediately at emergency stop and falls in free-run status, causing an accident such as machine collision, etc. Take measures to ensure safety on the entire system.



MR-J3-B Servo Amplifier Specifications: 200VAC, 30kW or Larger

Drive unit model		MR-J3-DU30KB	MR-J3-DU37KB
		Output	Rated voltage
	Rated current (A)	174	204
Main circuit power supply		The drive unit's main circuit power is supplied from the converter unit.	
Control circuit power supply	Voltage/frequency	1-phase 200 to 230VAC 50/60Hz	
	Rated current (A)	0.3	
	Permissible voltage fluctuation	1-phase 170 to 253VAC	
	Permissible frequency fluctuation	±5% maximum	
	Power consumption (W)	45	
Interface power supply		24VDC ±10% (required current capacity: 0.15A (Note 3))	
Control system		Sine-wave PWM control/current control system	
Dynamic brake		External option (Note 4)	
Safety features		Overcurrent shutdown, overload shutdown (electronic thermal), servo motor overheat protection, encoder fault protection, undervoltage/sudden power outage protection, overspeed protection, excess error protection	
Structure (IP rating)		Fan cooling open (IP00)	
Mass (kg [lb])		26 (57)	
Converter unit model		MR-J3-CR55K	
Output	Rated voltage	283 to 326VDC	
	Rated current (A)	215.9	
Main circuit power supply	Voltage/frequency (Note 1, 2)	3-phase 200 to 230VAC 50/60Hz	
	Rated current (A)	251.1	
	Permissible voltage fluctuation	3-phase 170 to 253VAC	
	Permissible frequency fluctuation	±5% maximum	
Control circuit power supply	Voltage/frequency	1-phase 200 to 230VAC 50/60Hz	
	Rated current (A)	0.3	
	Permissible voltage fluctuation	1-phase 170 to 253VAC	
	Permissible frequency fluctuation	±5% maximum	
	Power consumption (W)	45	
Interface power supply		24VDC ±10% (required current capacity: 0.13A (Note 3))	
Safety features		Regeneration overvoltage shutdown, regeneration fault protection, overload shutdown (electronic thermal), undervoltage/sudden power outage protection	
Structure (IP rating)		Fan cooling open (IP00)	
Mass (kg [lb])		25 (55)	
Environment	Ambient temperature	0 to 55°C (32 to 131°F) (non freezing), storage: -20 to 65°C (-4 to 149°F) (non freezing)	
	Ambient humidity	90% RH maximum (non condensing), storage: 90% RH maximum (non condensing)	
	Atmosphere	Indoors (no direct sunlight); no corrosive gas, inflammable gas, oil mist or dust	
	Elevation	1000m or less above sea level	
	Vibration	5.9m/s ² or less at 10 to 55Hz (directions of X, Y and Z axes)	

- Notes: 1. Rated output and speed of a servo motor are applicable when the drive unit and the converter unit, combined with the servo motor, are operated within the specified power supply voltage and frequency. Torque drops when the power supply voltage is below the specified value.
 2. For torque characteristics when combined with a servo motor, refer to the section "Servo motor torque characteristics" in this catalog.
 3. The interface power supply can be shared with the drive unit and the converter unit. When all of the input/output points are used, 0.15A is required for the drive unit, and 0.13A is required for the converter unit. The current capacity can be stepped down according to the number of input/output points in use. Refer to "MR-J3-□B SERVO AMPLIFIER INSTRUCTION MANUAL" for details.
 4. Use an optional external dynamic brake with the drive unit. Without the external dynamic brake, a servo motor does not stop immediately at emergency stop and falls in free-run status, causing an accident such as machine collision, etc. Take measures to ensure safety on the entire system.

Model designation

Servo motors

Servo amplifiers

Options

Peripheral equipment

MR-J3-B Safety series

MR-J3W series

Servo support software

Cautions

Warranty

Global FA centers



MR-J3-B Servo Amplifier Specifications: 400VAC, 22kW or Smaller

Servo amplifier model MR-J3-		60B4	100B4	200B4	350B4	500B4	700B4	11KB4	15KB4	22KB4	
Output	Rated voltage	3-phase 323VAC									
	Rated current (A)	1.5	2.8	5.4	8.6	14.0	17.0	32.0	41.0	63.0	
Main circuit power supply	Voltage/frequency (Note 1, 2)	3-phase 380 to 480VAC 50/60Hz									
	Rated current (A)	1.4	2.5	5.1	7.9	10.8	14.4	23.1	31.8	47.6	
	Permissible voltage fluctuation	3-phase 323 to 528VAC									
	Permissible frequency fluctuation	±5% maximum									
Control circuit power supply	Voltage/frequency	1-phase 380 to 480VAC 50/60Hz									
	Rated current (A)	0.1				0.2					
	Permissible voltage fluctuation	1-phase 323 to 528VAC									
	Permissible frequency fluctuation	±5% maximum									
Power consumption (W)		30				45					
Interface power supply		24VDC ±10% (required current capacity: 0.15A (Note 7))									
Tolerable regenerative power of regenerative resistor (W) (Note 3, 4)	Built-in regenerative resistor	15	15	100	100	130 (Note 9)	170 (Note 9)	—	—	—	
	External regenerative resistor (Standard accessory) (Note 5, 6)	—	—	—	—	—	—	500 (800)	850 (1300)	850 (1300)	
Control system		Sine-wave PWM control/current control system									
Dynamic brake		Built-in (Note 8, 10)					External option (Note 11)				
Safety features		Overcurrent shutdown, regeneration overvoltage shutdown, overload shutdown (electronic thermal), servo motor overheat protection, encoder fault protection, regeneration fault protection, undervoltage/sudden power outage protection, overspeed protection, excess error protection									
Structure (IP rating)		Natural-cooling open (IP00)			Fan cooling open (IP00)						
Environment	Ambient temperature	0 to 55°C (32 to 131°F) (non freezing), storage: -20 to 65°C (-4 to 149°F) (non freezing)									
	Ambient humidity	90% RH maximum (non condensing), storage: 90% RH maximum (non condensing)									
	Atmosphere	Indoors (no direct sunlight); no corrosive gas, inflammable gas, oil mist or dust									
	Elevation	1000m or less above sea level									
Vibration		5.9m/s ² or less at 10 to 55Hz (directions of X, Y and Z axes)									
Mass (kg [lb])		1.7 (3.7)	1.7 (3.7)	2.1 (4.6)	4.6 (10)	4.6 (10)	6.2 (14)	18 (40)	18 (40)	19 (42)	

- Notes: 1. Rated output and speed of a servo motor are applicable when the servo amplifier, combined with the servo motor, is operated within the specified power supply voltage and frequency. Torque drops when the power supply voltage is below the specified value.
2. For torque characteristics when combined with a servo motor, refer to the section "Servo motor torque characteristics" in this catalog.
3. Optimal regenerative resistor varies for each system. Select the most suitable regenerative resistor by using the capacity selection software.
4. Refer to the section "Options ●Optional regeneration unit" in this catalog for the tolerable regenerative power (W).
5. Servo amplifiers without an enclosed regenerative resistor are also available. Refer to "Servo Amplifier Model Designation" in this catalog for details.
6. The value in () is applicable when the external regenerative resistors, GRZG400-□Ω (standard accessory) are used with cooling fans (2 units of 92 X 92mm, minimum air flow: 1.0m³/min). Note that change in parameter No. PA02 is required.
7. 0.15A is the value when all of the input/output points are used. The current capacity can be stepped down according to the number of input/output points in use. Refer to "MR-J3-□B SERVO AMPLIFIER INSTRUCTION MANUAL" for details.
8. Special specification servo amplifiers without a dynamic brake are also available: MR-J3-□B4-ED. When using the servo amplifier without a dynamic brake, the servo motor does not stop immediately at alarm occurrence or power failure. Take measures to ensure safety on the entire system.
9. The servo amplifier built-in regenerative resistor is compatible with the maximum torque deceleration when the motor is used within the rated speed and the recommended load to motor inertia moment ratio. Contact your local sales office if the operating motor speed and the load to motor inertia moment ratio exceed the rated speed and the recommended ratio.
10. When using the built-in dynamic brake, refer to "MR-J3-□B SERVO AMPLIFIER INSTRUCTION MANUAL" for the permissible load to motor inertia moment ratio.
11. Use an optional external dynamic brake with the servo amplifier. Without the external dynamic brake, a servo motor does not stop immediately at emergency stop and falls in free-run status, causing an accident such as machine collision, etc. Take measures to ensure safety on the entire system.



MR-J3-B Servo Amplifier Specifications: 400VAC, 30kW or Larger

Drive unit model		MR-J3-DU30KB4	MR-J3-DU37KB4	MR-J3-DU45KB4	MR-J3-DU55KB4	
Drive unit	Output	Rated voltage	3-phase 323VAC			
		Rated current (A)	87	102	131	143
	Main circuit power supply		The drive unit's main circuit power is supplied from the converter unit.			
	Control circuit power supply	Voltage/frequency	1-phase 380 to 480VAC 50/60Hz			
		Rated current (A)	0.2			
		Permissible voltage fluctuation	1-phase 323 to 528VAC			
		Permissible frequency fluctuation	±5% maximum			
	Power consumption (W)		45			
	Interface power supply		24VDC ±10% (required current capacity: 0.15A (Note 3))			
	Control system		Sine-wave PWM control/current control system			
	Dynamic brake		External option (Note 4)			
	Safety features		Overcurrent shutdown, overload shutdown (electronic thermal), servo motor overheat protection, encoder fault protection, undervoltage/sudden power outage protection, overspeed protection, excess error protection			
	Structure (IP rating)		Fan cooling open (IP00)			
	Mass (kg [lb])		18 (40)		26 (57)	
Converter unit	Converter unit model		MR-J3-CR55K4			
	Output	Rated voltage	538 to 678VDC			
		Rated current (A)	113.8			
	Main circuit power supply	Voltage/frequency (Note 1, 2)	3-phase 380 to 480VAC 50/60Hz			
		Rated current (A)	132.2			
		Permissible voltage fluctuation	3-phase 323 to 528VAC			
		Permissible frequency fluctuation	±5% maximum			
	Control circuit power supply	Voltage/frequency	1-phase 380 to 480VAC 50/60Hz			
		Rated current (A)	0.2			
		Permissible voltage fluctuation	1-phase 323 to 528VAC			
		Permissible frequency fluctuation	±5% maximum			
	Power consumption (W)		45			
	Interface power supply		24VDC ±10% (required current capacity: 0.13A (Note 3))			
	Safety features		Regeneration overvoltage shutdown, regeneration fault protection, overload shutdown (electronic thermal), undervoltage/sudden power outage protection			
Structure (IP rating)		Fan cooling open (IP00)				
Mass (kg [lb])		25 (55)				
Drive unit/ Converter unit	Environment	Ambient temperature	0 to 55°C (32 to 131°F) (non freezing), storage: -20 to 65°C (-4 to 149°F) (non freezing)			
		Ambient humidity	90% RH maximum (non condensing), storage: 90% RH maximum (non condensing)			
		Atmosphere	Indoors (no direct sunlight); no corrosive gas, inflammable gas, oil mist or dust			
		Elevation	1000m or less above sea level			
		Vibration	5.9m/s ² or less at 10 to 55Hz (directions of X, Y and Z axes)			

- Notes: 1. Rated output and speed of a servo motor are applicable when the drive unit and the converter unit, combined with the servo motor, are operated within the specified power supply voltage and frequency. Torque drops when the power supply voltage is below the specified value.
 2. For torque characteristics when combined with a servo motor, refer to the section "Servo motor torque characteristics" in this catalog.
 3. The interface power supply can be shared with the drive unit and the converter unit. When all of the input/output points are used, 0.15A is required for the drive unit, and 0.13A is required for the converter unit. The current capacity can be stepped down according to the number of input/output points in use. Refer to "MR-J3-□B SERVO AMPLIFIER INSTRUCTION MANUAL" for details.
 4. Use an optional external dynamic brake with the drive unit. Without the external dynamic brake, a servo motor does not stop immediately at emergency stop and falls in free-run status, causing an accident such as machine collision, etc. Take measures to ensure safety on the entire system.

Model designation

Servo motors

Servo amplifiers

Options

Peripheral equipment

MR-J3-B Safety

MR-J3W series

Servo support software

Cautions

Warranty

Global FA centers

MELSERVO-J3

MR-J3-□B□ Standard Wiring Diagram

● Connection example

Main circuit/control circuit power supply connection

The connection differs according to the power voltage.
→Refer to main/control circuit power supply connection examples (1) to (6).

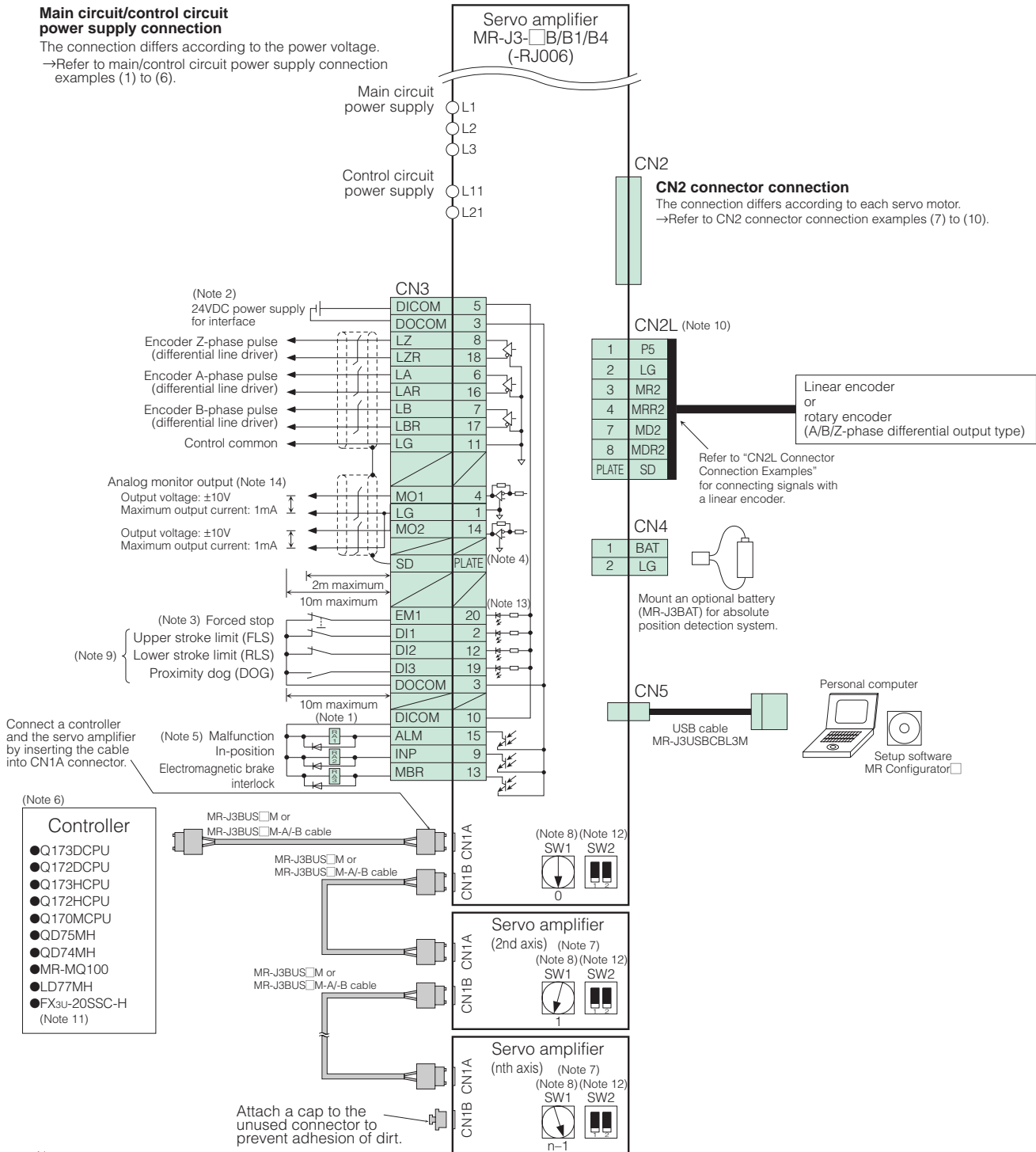

Notes:

- Do not reverse the diode's direction. Connecting it backwards may cause the servo amplifier to malfunction such that the signals are not output, and the forced stop and other safety circuits are inoperable.
- Use the power supply 24VDC±10% (required current capacity: 0.15A). 0.15A is the value when all of the input/output points are used. Note that the current capacity can be stepped down according to the number of input/output points in use. Refer to "MR-J3-□B SERVO AMPLIFIER INSTRUCTION MANUAL" for details.
- The forced stop (EM1) signal is issued for each servo amplifier axis individually. Use this signal as necessary when Q173DCPU, Q172DCPU, Q173HCPU, Q172HCPU, Q170MCPUCPU, QD75MH, QD74MH, MR-MQ100 or LD77MH is connected. When not using, invalidate the forced stop input by parameter No. PA04, or short-circuit EM1 and DOCOM in the connector. For overall system, apply the emergency stop on the controller side.
- Connect the shield wire securely to the plate inside the connector (ground plate).
- The malfunction (ALM) signal (normally closed contact) is conducted to DOCOM in normal alarm-free condition.
- For details on the controllers, refer to relevant controller's programming manual or user's manual.
- Connections for the second and following axes are omitted.
- Up to 16 axes (n = 1 to 16) can be set using the axis selection rotary switch (SW1).
- Devices can be assigned for DI1, DI2 and DI3 with controller setting. Refer to the controller's instruction manuals for details on setting. These devices can be assigned with the controller: Q173DCPU, Q172DCPU, Q173HCPU, Q172HCPU, Q170MCPUCPU, QD75MH, QD74MH, MR-MQ100 or LD77MH.
- CN2L connector is available only for the fully closed loop control compatible servo amplifier, MR-J3-□B-□-RJ006.
- FX3u-20SSC-H is not compatible with the fully closed loop control compatible servo amplifier, MR-J3-□B-□-RJ006.
- Test operation select switch (SW2-1) is used to perform test operation mode with MR Configurator2 or MR Configurator. SW2-2 is for manufacturer setting.
- This is for sink wiring. Source wiring is also possible. Refer to "MR-J3-□B SERVO AMPLIFIER INSTRUCTION MANUAL" for details.
- Output voltage range varies depending on the monitored signal.

MR-J3-□B□ Servo Amplifier Dimensions

(Unit: mm)

● MR-J3-10B, 20B, 10B1, 20B1 (Note 1)

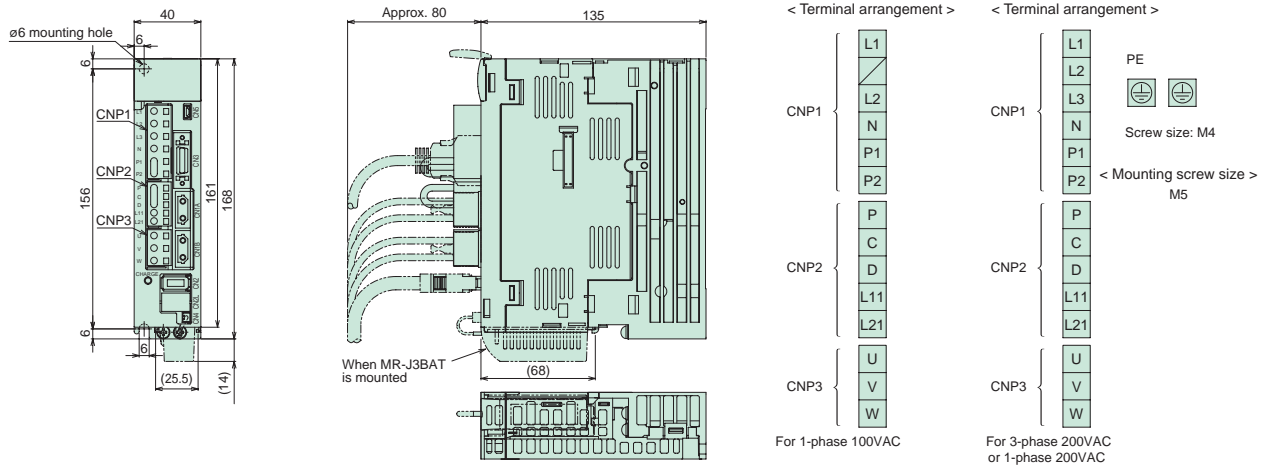

● MR-J3-40B, 60B, 40B1 (Note 1)

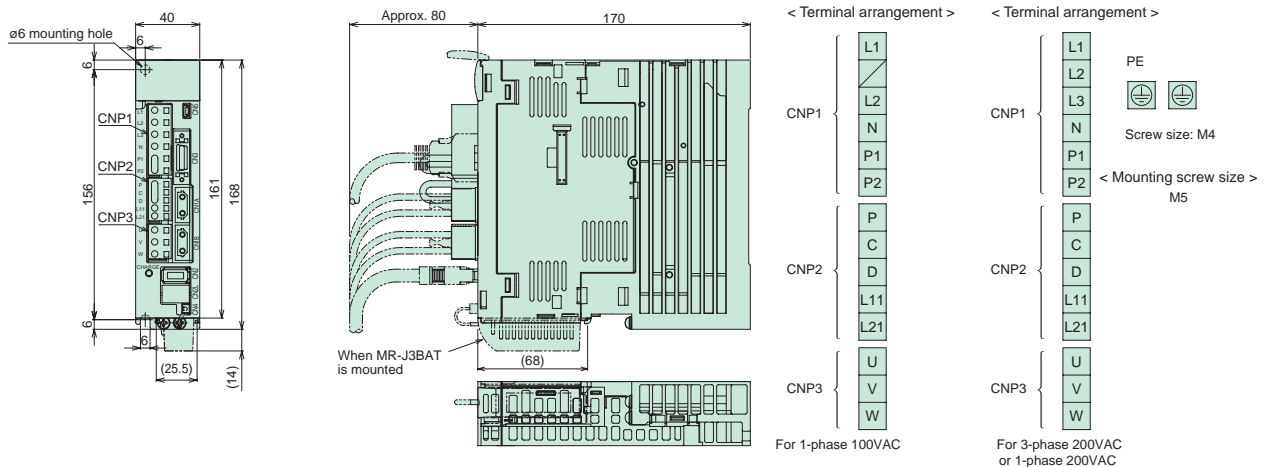

● MR-J3-70B, 100B (Note 1)

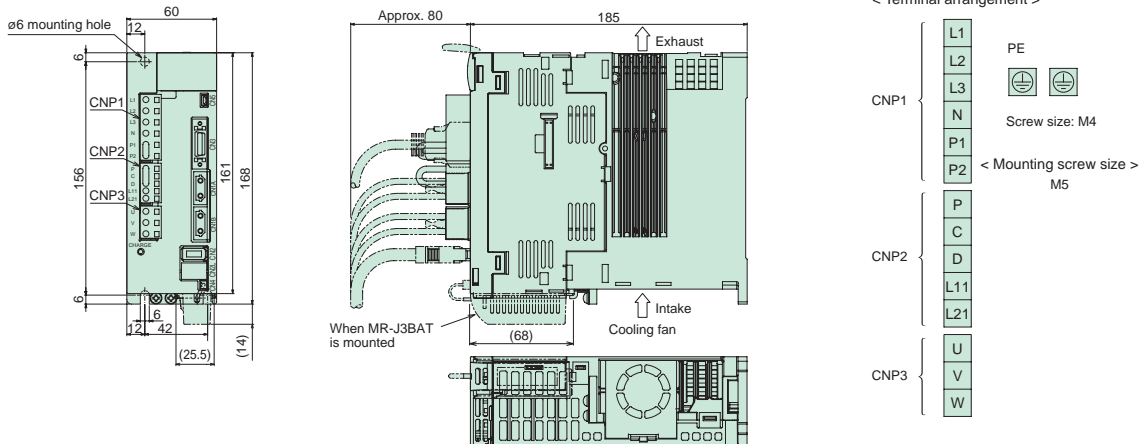

Notes: 1. CNP1, CNP2 and CNP3 connectors (insertion type) are supplied with the servo amplifier.

Model designation

Servo motors

Servo amplifiers

Options

Peripheral equipment

MR-J3-B safety

MR-J3W series

Servo support software

Cautions

Warranty

Global FA centers

MELSERVO-J3

MR-J3-□B□ Servo Amplifier Dimensions

(Unit: mm)

● MR-J3-60B4, 100B4 (Note 1)

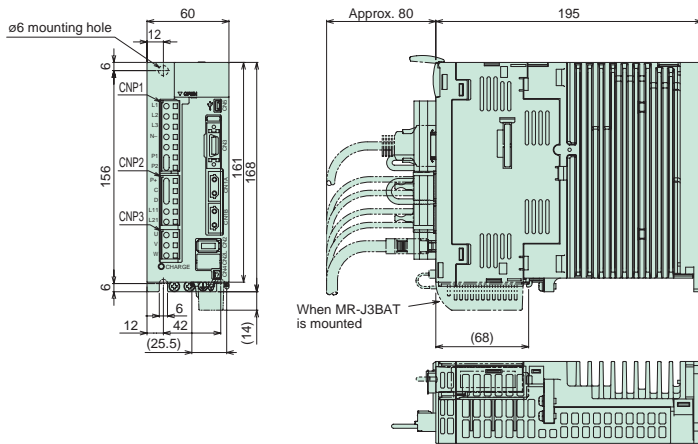

< Terminal arrangement >

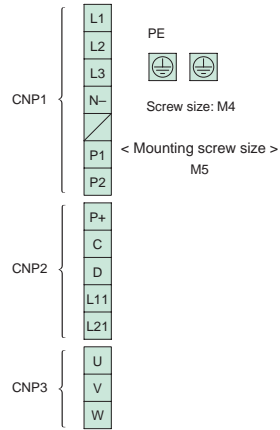

● MR-J3-200BN*, 200B4 (Note 1)

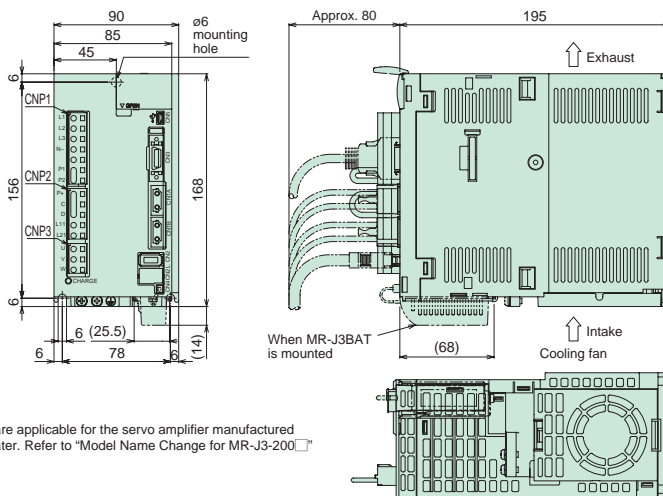

< Terminal arrangement >

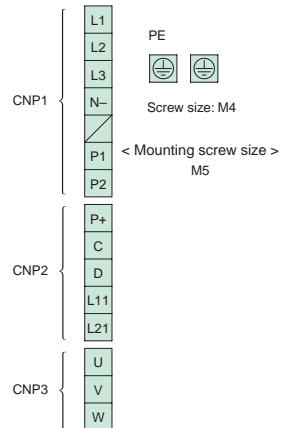

* The dimensions are applicable for the servo amplifier manufactured on July 2010 or later. Refer to "Model Name Change for MR-J3-200□" in this catalog.

● MR-J3-350B (Note 1)

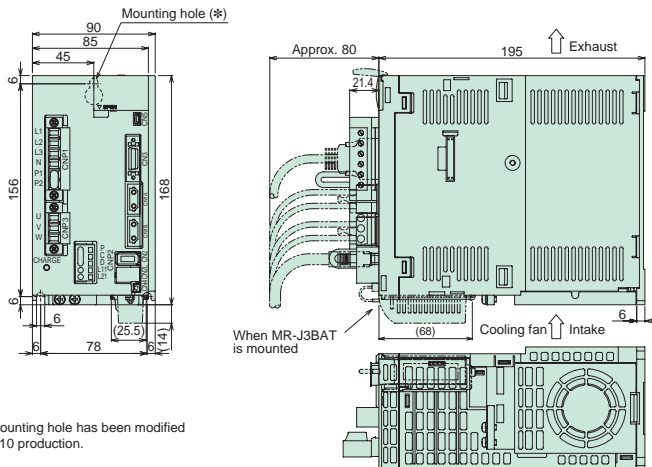

< Terminal arrangement >

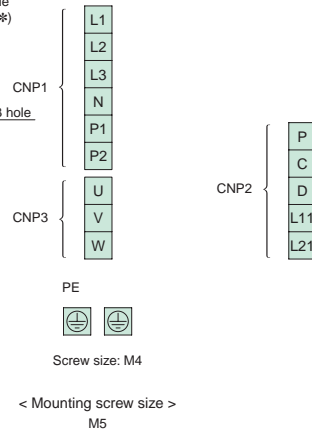

* The shape of the mounting hole has been modified from September 2010 production.

Notes: 1. CNP1, CNP2 and CNP3 connectors (insertion type) are supplied with the servo amplifier.

(Unit: mm)

● MR-J3-500B, 350B4, 500B4

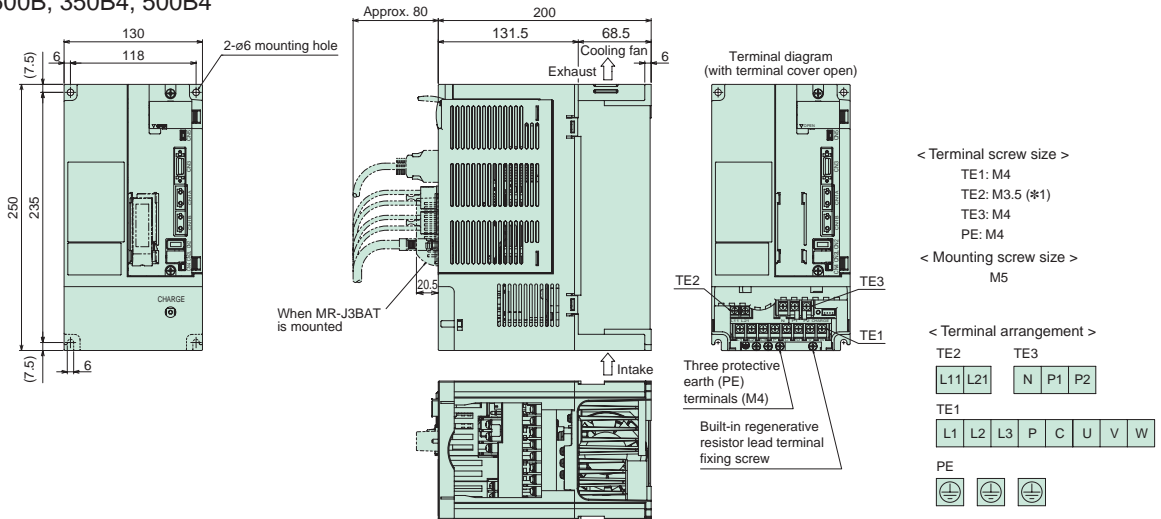

*1. TE2 terminal screw size has been changed to M3.5 from April 2007.
For the servo amplifiers manufactured on or before March 2007, the terminal screw size is M3.

● MR-J3-700B, 700B4

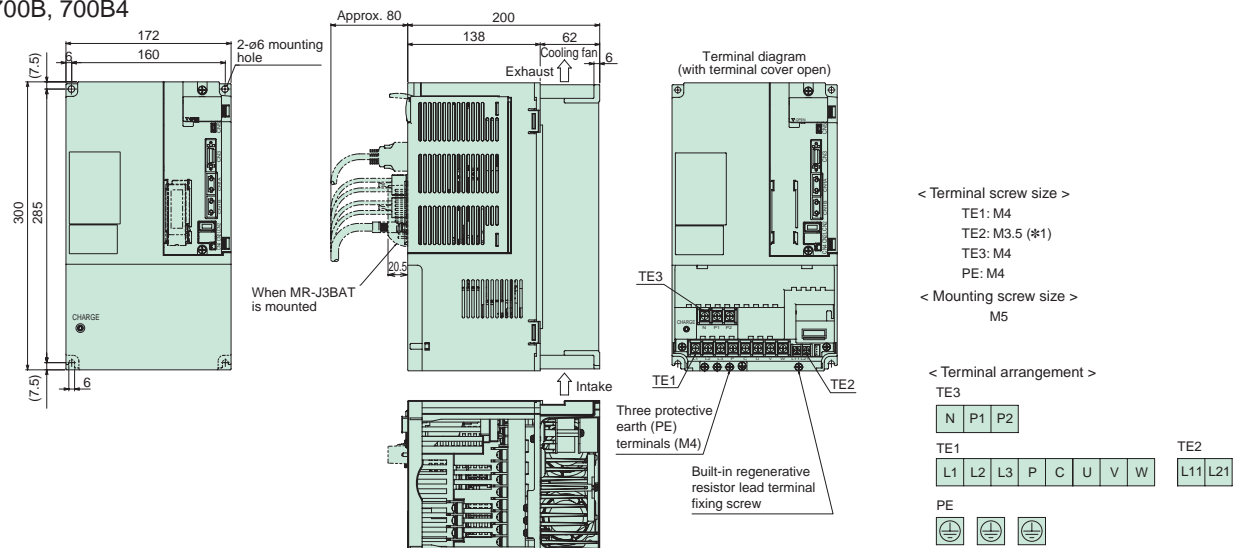

*1. TE2 terminal screw size has been changed to M3.5 from April 2007.
For the servo amplifiers manufactured on or before March 2007, the terminal screw size is M3.

● MR-J3-11KB to 22KB, 11KB4 to 22KB4

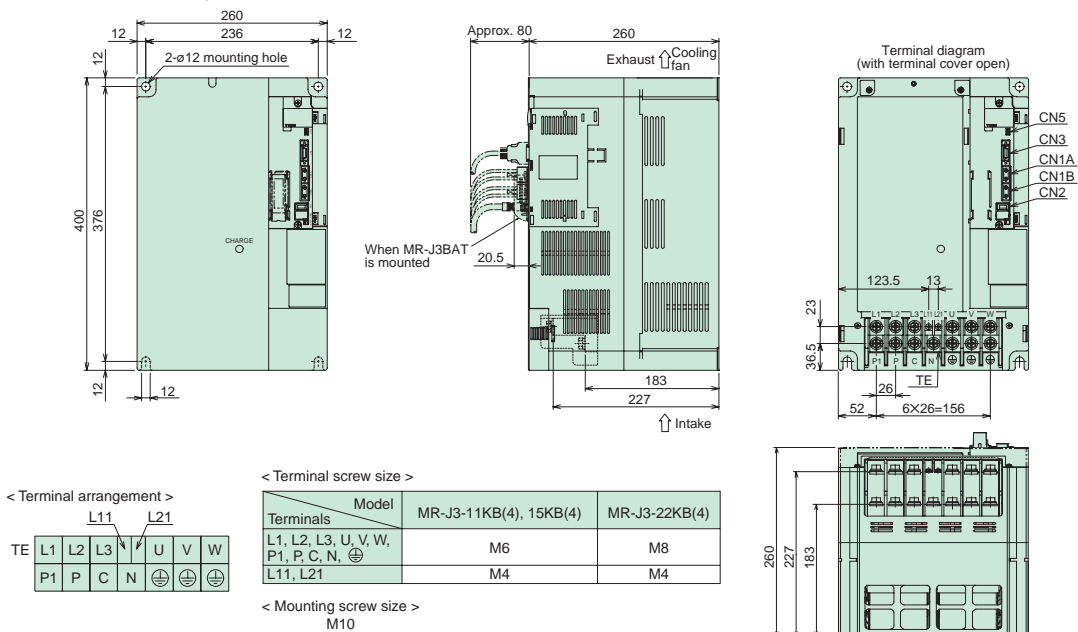

Model designation
Servo motors
Servo amplifiers
Options
Peripheral equipment
MR-J3-BSafety
MR-J3W series
Servo support software
Cautions
Warranty
Global FA centers

MELSERVO-J3

MR-J3-DU□B(4) Drive Unit Dimensions

(Unit: mm)

- MR-J3-DU30KB, DU37KB, DU45KB4, DU55KB4 (Note 2)

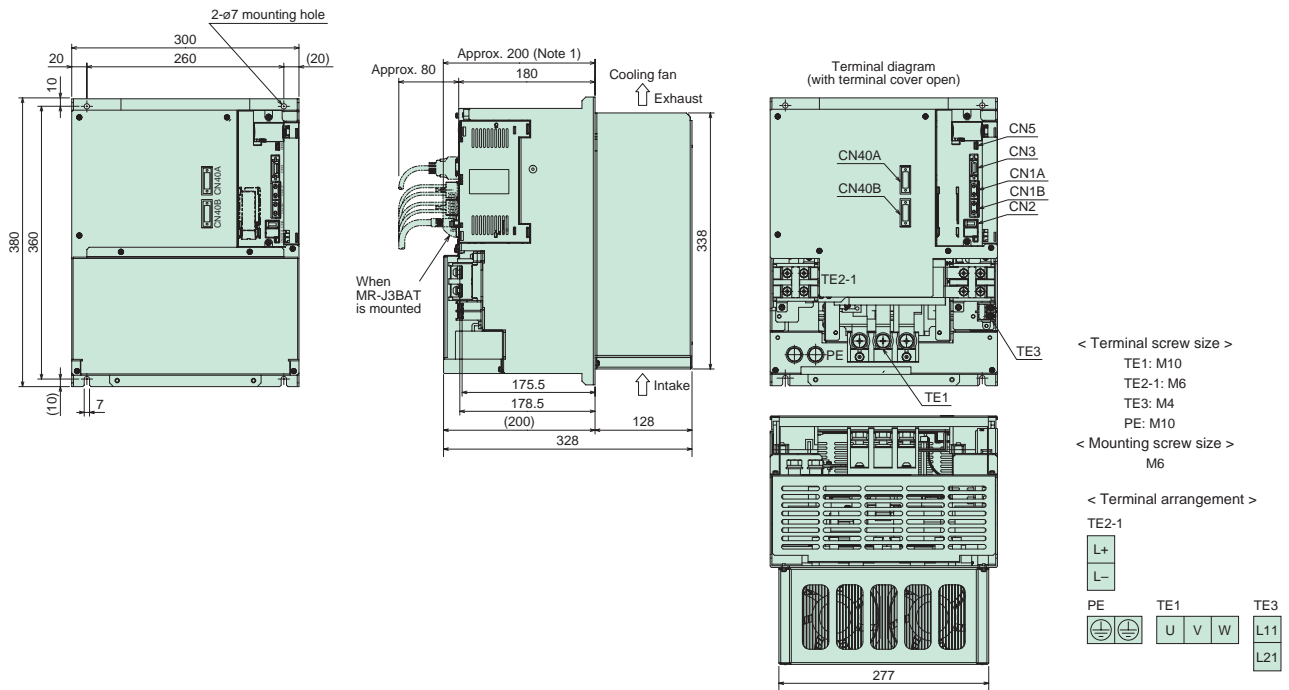

- MR-J3-DU30KB4, DU37KB4 (Note 2)

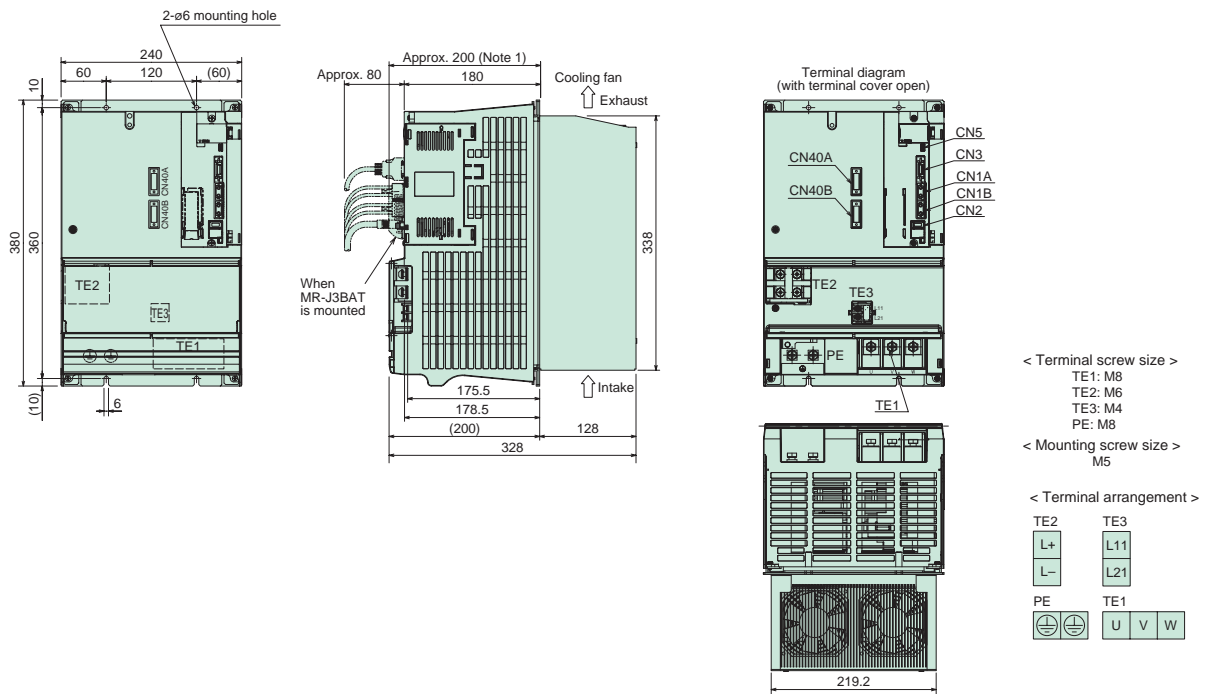

Notes: 1. The dimension is applicable when MR-J3BAT is mounted.

2. For the converter unit dimensions and the panel-cut dimensions for converter unit and drive unit, refer to the section "Converter unit dimensions".

Retaining the high performance, functionality and usability of the MELSERVO-J3 Series, MR-J3-B-RJ006 is able to read position feedback signals from a load-side encoder such as a linear encoder. MR-J3-B-RJ006 has realized less installation space and reduced wiring as compared to the MR-J2S Series.



Features: MR-J3-B-RJ006 (Fully Closed Loop Control Compatible)

- High accuracy position control is possible with the fully closed loop control system.
- Dual feedback control provides the highest possible positioning response by using the position feedback signals from the motor encoder during high-speed rotation, and from the load-side encoder, such as a linear encoder, when positioning (stopping).
- Fast, accurate and reliable system can be configured with a serial interface linear encoder for MELSERVO-J3 Series.
- Absolute position detection system is easily configured without a battery by using an absolute type linear encoder with compatible serial interface.

Simple overview of dual feedback control block

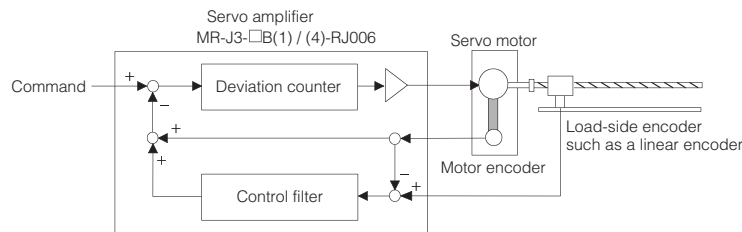

System Configurations

Fully closed loop control system can be easily configured by connecting a load-side encoder to CN2L connector (load-side encoder interface). Select a load-side encoder in accordance with the following:

$4096(2^{12}) \leq \text{the number of the load-side encoder pulses per servo motor rotation} \leq 67108864(2^{26})$

(1) When using a linear encoder with compatible serial interface or A/B/Z-phase pulse train interface:

Applicable for the absolute position detection system when an absolute type encoder is used. A battery (MR-J3BAT) is not required. For linear encoders, refer to the section "MR-J3-□B□-RJ006 Compatible Linear Encoders" in this catalog.

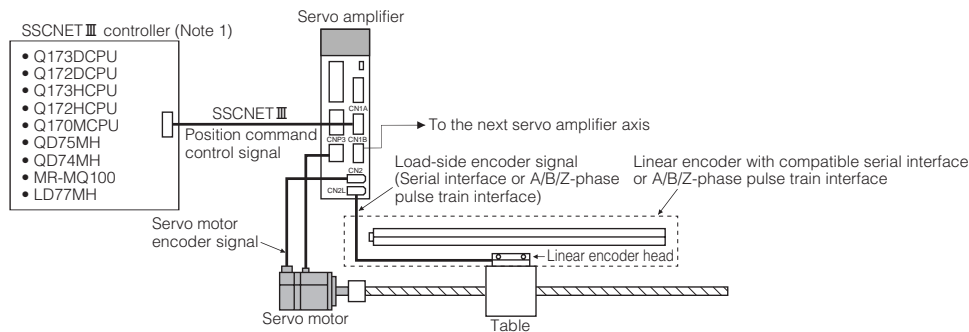

(2) When using a rotary encoder with compatible A/B/Z-phase pulse train interface:

Not applicable for the absolute position detection system.

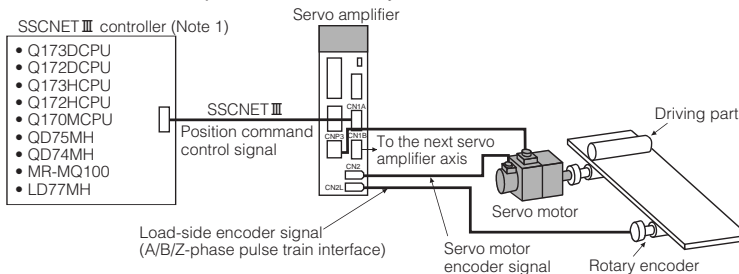

Notes: 1. For details on the controllers, refer to relevant controllers' programming manual or user's manual.

Fully Closed Loop Diagnostic Functions of MR Configurator2 (SW1DNC-MRC2-E)

With the fully closed loop diagnostic functions, monitoring and reading/writing of parameters related to the fully closed loop function are possible.

[Fully Closed Loop Diagnostics] window

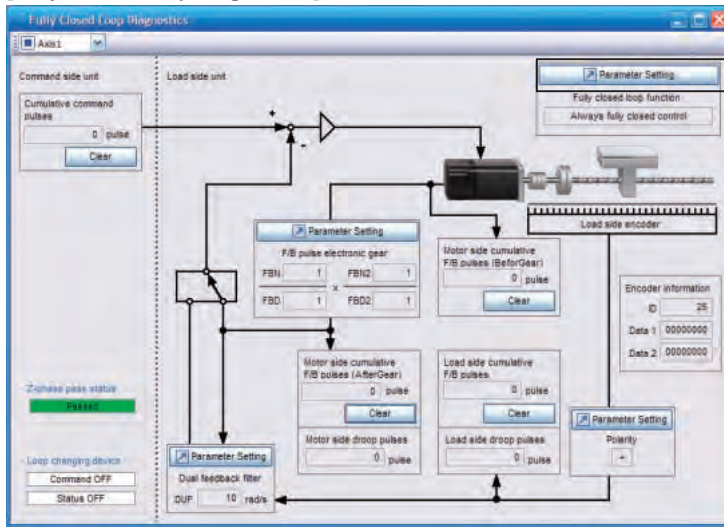

[Parameter Setting] window

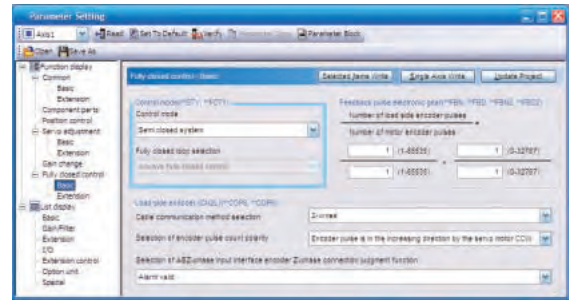

Note: The screens shown on this page are for reference and may differ from the actual screens.

● Items displayed in the [Fully Closed Loop Diagnostics] window

Item	Description
Cumu. com. pulses	Counts and displays the position command input pulses. Resets to 0 by pressing the "Clear" button.
Motor side cumu. feedback pulses (before gear)	Counts and displays the feedback pulses from the servo motor encoder. (Motor encoder unit) Resets to 0 by pressing the "Clear" button.
Motor side cumu. feedback pulses (after gear)	Counts and displays the feedback pulses from the servo motor encoder. (Load-side encoder unit) Resets to 0 by pressing the "Clear" button.
Load side cumu. feedback pulses	Counts and displays the feedback pulses from the load-side encoder. Resets to 0 by pressing the "Clear" button.
Motor side droop pulses	Displays the difference between the motor-side position and the commanded position.
Load side droop pulses	Displays the difference between the load-side position and the commanded position.
Polarity	Displays "+" or "-" according to the load-side encoder polarity.
Encoder info.	Displays information about the load-side encoder. The displayed items vary depending on the type of the load-side encoder.
Z-phase pass status	Displays Z-phase pass status of the motor encoder when the fully closed loop system is "Invalid". Displays Z-phase pass status of the load-side encoder when the fully closed loop system is "Valid" or in "Semi closed loop control/Fully closed loop switching".
Loop changing device	Displays only when "Semi closed loop control/Fully closed loop control switching" is selected in the fully closed loop system. Displays the Semi closed loop control/Fully closed loop control switching command and its state.

● Items displayed in the [Parameter Setting] window

Displays the [Parameter Setting] window by pressing the "Parameter Setting" button in the [Fully Closed Loop Diagnostics] window.

Item	Description
Control mode	Selects control mode. Select "Fully closed loop system" when using the fully closed loop control.
Feedback pulse electronic gear	Sets the number of the load-side encoder pulses per servo motor encoder pulse.
Load-side encoder (CN2L)	Selects communication method of the load-side encoder cable for CN2L connector, encoder polarity and A/B/Z-phase input interface encoder Z-phase connection judgment function.
Fully closed dual feedback filter	Sets the band of dual feedback filter for the fully closed loop control.
Controller monitor	Sets the encoder used for cumulative feedback pulse monitor for controller display.
Fully closed loop control	Selects the fully closed loop control error detection function, the position deviation error detection method and the fully closed loop control error reset. Deviation error detection level can be also set for the fully closed loop control detection.



MR-J3-B-RJ006 Servo Amplifier Specifications: 100VAC/200VAC

Servo amplifier model MR-J3-□-RJ006		10B	20B	40B	60B	70B	100B	200BN	350B	500B	700B	11KB	15KB	22KB	10B1	20B1	40B1	
Output	Rated voltage	3-phase 170VAC																
	Rated current (A)	1.1	1.5	2.8	3.2	5.8	6.0	11.0	17.0	28.0	37.0	68.0	87.0	126.0	1.1	1.5	2.8	
Main circuit power supply	Voltage/frequency (Note 1, 2)	3-phase 200 to 230VAC 50/60Hz or 1-phase 200 to 230VAC 50/60Hz (Note 10)					3-phase 200 to 230VAC 50/60Hz								1-phase 100 to 120VAC 50/60Hz			
	Rated current (A)	0.9	1.5	2.6	3.2	3.8	5.0	10.5	16.0	21.7	28.9	46.0	64.0	95.0	3.0	5.0	9.0	
	Permissible voltage fluctuation	For 3-phase 200 to 230VAC: 3-phase 170 to 253VAC For 1-phase 200 to 230VAC: 1-phase 170 to 253VAC (Note 10)					3-phase 170 to 253VAC								1-phase 85 to 132VAC			
	Permissible frequency fluctuation	±5% maximum																
Control circuit power supply	Voltage/frequency	1-phase 200 to 230VAC 50/60Hz (Note 10)					1-phase 200 to 230VAC 50/60Hz								1-phase 100 to 120VAC 50/60Hz			
	Rated current (A)	0.2					0.3					0.4						
	Permissible voltage fluctuation	1-phase 170 to 253VAC (Note 10)					1-phase 170 to 253VAC								1-phase 85 to 132VAC			
	Permissible frequency fluctuation	±5% maximum																
	Power consumption (W)	30					45					30						
Interface power supply		24VDC ±10% (required current capacity: 0.15A (Note 7))																
Load-side encoder interface	Serial interface		Mitsubishi high-speed serial communication															
	Pulse train interface	Input signal	A/B/Z-phase differential input signal															
		Minimum phase difference	200ns															
Tolerable regenerative power of regenerative resistor (W) (Note 3, 4)	Built-in regenerative resistor		—	10	10	10	20	20	100	100	130	170	—	—	—	—	10	10
	External regenerative resistor (Standard accessory) (Note 5, 6)		—	—	—	—	—	—	—	—	—	—	500 (800)	850 (1300)	850 (1300)	—	—	—
Control system		Sine-wave PWM control/current control system																
Dynamic brake		Built-in (Note 8, 11)										External option (Note 12)			Built-in (Note 8, 11)			
Safety features		Overcurrent shutdown, regeneration overvoltage shutdown, overload shutdown (electronic thermal), servo motor overheat protection, encoder fault protection, regeneration fault protection, undervoltage/sudden power outage protection, overspeed protection, excess error protection																
Structure (IP rating)		Natural-cooling open (IP00)					Fan cooling open (IP00)								Natural-cooling open (IP00)			
Environment	Ambient temperature (Note 9)		0 to 55°C (32 to 131°F) (non freezing), storage: -20 to 65°C (-4 to 149°F) (non freezing)															
	Ambient humidity		90% RH maximum (non condensing), storage: 90% RH maximum (non condensing)															
	Atmosphere		Indoors (no direct sunlight); no corrosive gas, inflammable gas, oil mist or dust															
	Elevation		1000m or less above sea level															
	Vibration		5.9m/s ² or less at 10 to 55Hz (directions of X, Y and Z axes)															
Mass (kg [lb])		0.8 (1.8)	0.8 (1.8)	1.0 (2.2)	1.0 (2.2)	1.4 (3.1)	1.4 (3.1)	2.1 (4.6)	2.3 (5.1)	4.6 (10)	6.2 (14)	18 (40)	18 (40)	19 (42)	0.8 (1.8)	0.8 (1.8)	1.0 (2.2)	

- Notes: 1. Rated output and speed of a servo motor are applicable when the servo amplifier, combined with the servo motor, is operated within the specified power supply voltage and frequency. Torque drops when the power supply voltage is below the specified value.
2. For torque characteristics when combined with a servo motor, refer to the section "Servo motor torque characteristics" in this catalog.
3. Optimal regenerative resistor varies for each system.
4. Refer to the section "Options ●Optional regeneration unit" in this catalog for the tolerable regenerative power (W).
5. Servo amplifiers without an enclosed regenerative resistor are also available. Refer to "Servo Amplifier Model Designation" in this catalog for details.
6. The value in () is applicable when the external regenerative resistors, GRZG400-□Ω (standard accessory) are used with cooling fans (2 units of 92 × 92mm, minimum air flow: 1.0m³/min). Note that change in parameter No. PA02 is required.
7. 0.15A is the value when all of the input/output points are used. The current capacity can be stepped down according to the number of input/output points in use. Refer to "MR-J3-□B-RJ006 SERVO AMPLIFIER INSTRUCTION MANUAL" for details.
8. Special specification servo amplifiers without a dynamic brake are also available: MR-J3-□B(1)-RU006. When using the servo amplifier without a dynamic brake, the servo motor does not stop immediately at alarm occurrence or power failure. Take measures to ensure safety on the entire system.
9. MR-J3-350B-RJ006 or smaller servo amplifiers can be mounted closely. In this case, operate them at the ambient temperature of 0 to 45°C (32 to 113°F) or at 75% or less of the effective load ratio.
10. Special specification servo amplifiers for 1-phase 200 to 240VAC are also available: MR-J3-□B-RJ006U004. The permissible voltage fluctuation for MR-J3-□B-RJ006U004 is 1-phase 170 to 264VAC.
11. When using the built-in dynamic brake, refer to "MR-J3-□B SERVO AMPLIFIER INSTRUCTION MANUAL" for the permissible load to motor inertia moment ratio.
12. Use an optional external dynamic brake with the servo amplifier. Without the external dynamic brake, a servo motor does not stop immediately at emergency stop and falls in free-run status, causing an accident such as machine collision, etc. Take measures to ensure safety on the entire system.

Model designation
Servo motors
Servo amplifiers
Options
Peripheral equipment
MR-J3-B Safety series
MR-J3W series
Servo support software
Cautions
Warranty
Global FA centers



MR-J3-B-RJ006 Servo Amplifier Specifications: 400VAC

Servo amplifier model MR-J3-□-RJ006		60B4	100B4	200B4	350B4	500B4	700B4	11KB4	15KB4	22KB4	
Output	Rated voltage	3-phase 323VAC									
	Rated current (A)	1.5	2.8	5.4	8.6	14.0	17.0	32.0	41.0	63.0	
Main circuit power supply	Voltage/frequency (Note 1, 2)	3-phase 380 to 480VAC 50/60Hz									
	Rated current (A)	1.4	2.5	5.1	7.9	10.8	14.4	23.1	31.8	47.6	
	Permissible voltage fluctuation	3-phase 323 to 528VAC									
	Permissible frequency fluctuation	±5% maximum									
Control circuit power supply	Voltage/frequency	1-phase 380 to 480VAC 50/60Hz									
	Rated current (A)	0.1			0.2						
	Permissible voltage fluctuation	1-phase 323 to 528VAC									
	Permissible frequency fluctuation	±5% maximum									
	Power consumption (W)	30			45						
Interface power supply		24VDC ±10% (required current capacity: 0.15A (Note 7))									
Load-side encoder interface	Serial interface		Mitsubishi high-speed serial communication								
	Pulse train interface	Input signal	A/B/Z-phase differential input signal								
		Minimum phase difference	200ns								
Tolerable regenerative power of regenerative resistor (W) (Note 3, 4)	Built-in regenerative resistor		15	15	100	100	130 (Note 9)	170 (Note 9)	—	—	—
	External regenerative resistor (Standard accessory) (Note 5, 6)		—	—	—	—	—	—	500 (800)	850 (1300)	850 (1300)
Control system		Sine-wave PWM control/current control system									
Dynamic brake		Built-in (Note 8, 10)					External option (Note 11)				
Safety features		Overcurrent shutdown, regeneration overvoltage shutdown, overload shutdown (electronic thermal), servo motor overheat protection, encoder fault protection, regeneration fault protection, undervoltage/sudden power outage protection, overspeed protection, excess error protection									
Structure (IP rating)		Natural-cooling open (IP00)			Fan cooling open (IP00)						
Environment	Ambient temperature		0 to 55°C (32 to 131°F) (non freezing), storage: -20 to 65°C (-4 to 149°F) (non freezing)								
	Ambient humidity		90% RH maximum (non condensing), storage: 90% RH maximum (non condensing)								
	Atmosphere		Indoors (no direct sunlight); no corrosive gas, inflammable gas, oil mist or dust								
	Elevation		1000m or less above sea level								
	Vibration		5.9m/s ² or less at 10 to 55Hz (directions of X, Y and Z axes)								
Mass (kg [lb])		1.7 (3.7)	1.7 (3.7)	2.1 (4.6)	4.6 (10)	4.6 (10)	6.2 (14)	18 (40)	18 (40)	19 (42)	

- Notes: 1. Rated output and speed of a servo motor are applicable when the servo amplifier, combined with the servo motor, is operated within the specified power supply voltage and frequency. Torque drops when the power supply voltage is below the specified value.
2. For torque characteristics when combined with a servo motor, refer to the section "Servo motor torque characteristics" in this catalog.
3. Optimal regenerative resistor varies for each system.
4. Refer to the section "Options ●Optional regeneration unit" in this catalog for the tolerable regenerative power (W).
5. Servo amplifiers without an enclosed regenerative resistor are also available. Refer to "Servo Amplifier Model Designation" in this catalog for details.
6. The value in () is applicable when the external regenerative resistors, GRZG400-□Ω (standard accessory) are used with cooling fans (2 units of 92 X 92mm, minimum air flow: 1.0m³/min). Note that change in parameter No. PA02 is required.
7. 0.15A is the value when all of the input/output points are used. The current capacity can be stepped down according to the number of input/output points in use. Refer to "MR-J3-□B-RJ006 SERVO AMPLIFIER INSTRUCTION MANUAL" for details.
8. Special specification servo amplifiers without a dynamic brake are also available: MR-J3-□B4-RU006. When using the servo amplifier without a dynamic brake, the servo motor does not stop immediately at alarm occurrence or power failure. Take measures to ensure safety on the entire system.
9. The servo amplifier built-in regenerative resistor is compatible with the maximum torque deceleration when the motor is used within the rated speed and the recommended load to motor inertia moment ratio. Contact your local sales office if the operating motor speed and the load to motor inertia moment ratio exceed the rated speed and the recommended ratio.
10. When using the built-in dynamic brake, refer to "MR-J3-□B SERVO AMPLIFIER INSTRUCTION MANUAL" for the permissible load to motor inertia moment ratio.
11. Use an optional external dynamic brake with the servo amplifier. Without the external dynamic brake, a servo motor does not stop immediately at emergency stop and falls in free-run status, causing an accident such as machine collision, etc. Take measures to ensure safety on the entire system.

CN2L Connector Connection Examples (Note 1)

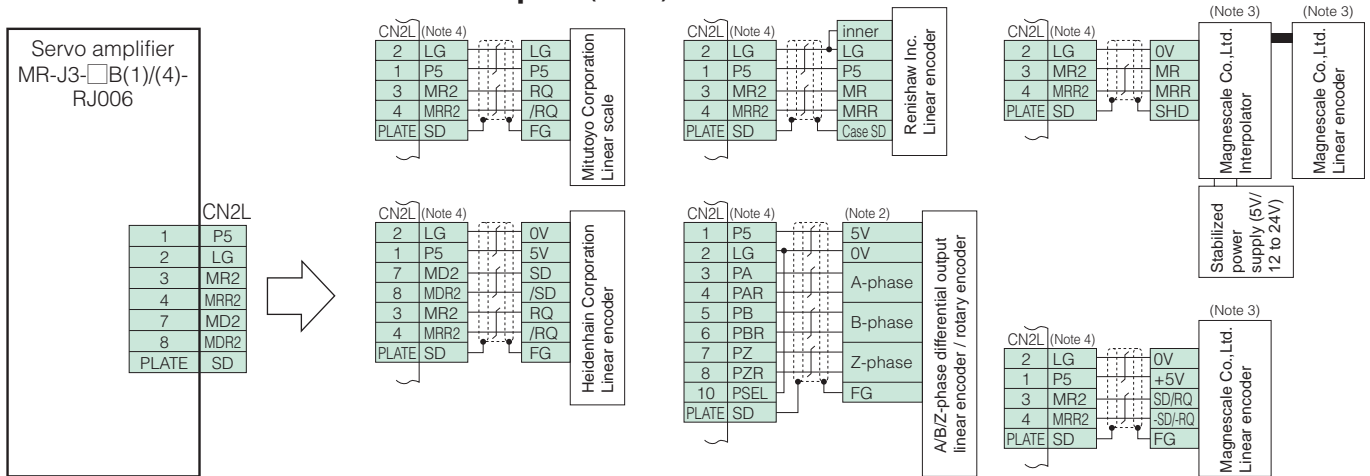

- Notes: 1. When manufacturing the linear encoder connection cable, use an optional CN2L connector set (MR-J3CN2). Refer to "MR-J3-□B-RJ006 SERVO AMPLIFIER INSTRUCTION MANUAL" for details on manufacturing the cable.
 2. If the encoder's current consumption exceeds 350mA, supply power from an external source.
 3. Former company name: Sony Manufacturing System Corporation (changed since April 2010)
 4. For the number of the wire pairs for LG and P5, refer to "MR-J3-□B-RJ006 INSTRUCTION MANUAL".

MR-J3-□B-□-RJ006 Compatible Linear Encoders (Note 1)

Linear encoder type	Manufacturer	Model (Note 12)	Resolution	Rated speed (Note 2)	Maximum effective measurement length (Note 7)	Communication method	Position detection system
Mitsubishi serial interface compatible	Magnescale Co., Ltd. (Note 11)	SR77	0.05μm / 0.01μm	3.3m/s	2040mm	2-wire type	Absolute
		SR87			3040mm		
		AT343A	0.05μm	2.0m/s	3000mm		
		AT543A-SC			2200mm		
	Mitutoyo Corporation	AT545A-SC	20/4096 (μm) (Approx. 0.005μm)	2.5m/s	2200mm	2-wire type	Absolute
		ST741 A	0.5μm	4.0m/s	6000mm		
		ST742A					
		ST743A					
	ST744 A	0.1μm					
	Heidenhain Corporation	LC 493M (Note 8)	0.05μm / 0.01μm	3.0m/s	2040mm	4-wire type	Absolute
		LC 193M (Note 9)			4240mm		
	Incremental type	Magnescale Co., Ltd. (Note 11)	SR75	0.05μm / 0.01μm	3.3m/s	2040mm	2-wire type
SR85			3040mm				
Renishaw Inc.		SL710+PL101-R/RH +MJ830 or MJ831 (Note 3)	0.2μm (Note 4)	6.4m/s	100000mm	2-wire type	
		RGH26P	5μm	4.0m/s	70000mm		
		RGH26Q	1μm	3.2m/s			
RGH26R		0.5μm	1.6m/s				
Heidenhain Corporation	LIDA 485+EIB 392M (Note 10)	20/16384 (μm) (Approx. 1.22nm)	4.0m/s	30040mm	4-wire type		
	LIDA 487+EIB 392M (Note 10)			6040mm			
A/B/Z-phase differential output type (Note 5)	Incremental type	Not designated	-	Within tolerable resolution range (Note 6)	Depends on linear encoder	Depends on linear encoder	Differential 3-pair type

- Notes: 1. Consult with the relevant linear encoder manufacturer for details on the linear encoder's working environment and specifications.
 2. The indicated values are the linear encoder's rated speed when used in combination with the Mitsubishi fully closed loop control compatible servo amplifier. The values may differ from each manufacturer's specifications.
 3. SH13 is out of production. Contact Magnescale Co., Ltd. for more details.
 4. The resolution varies according to the setting value of the interpolator, MJ830/MJ831 manufactured by Magnescale Co., Ltd. Set the resolution between the minimum resolution and 5μm.
 5. Output the A-phase, B-phase and Z-phase signals in the differential line driver. The phase difference of A-phase pulse and B-phase pulse, and the width of Z-phase pulse must be 200ns or wider. Home position return is not possible with a linear encoder which is not equipped with a Z-phase.
 6. The tolerable resolution range is 0.005μm to 5μm. Select the linear encoder within this range.
 7. The maximum length of Mitsubishi serial interface communication cable is 30m.
 8. LC 493M is a replacement for LC 491M. Contact Heidenhain Corporation for more details.
 9. LC 193M is a replacement for LC 192M. Contact Heidenhain Corporation for more details.
 10. EIB 392M is a replacement for APE 391M. Contact Heidenhain Corporation for more details.
 11. Former company name: Sony Manufacturing System Corporation (changed since April 2010)
 12. For servo amplifiers' software versions that are compatible with the linear encoders, refer to "List of compatible servo amplifier software versions" in this catalog.

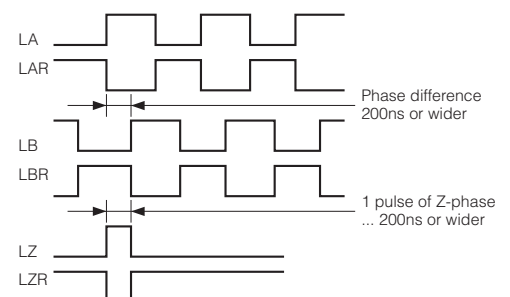

MELSERVO-J3

MR-J3-□B□-RJ006 Servo Amplifier Dimensions

(Unit: mm)

- MR-J3-10B-RJ006, 20B-RJ006, 10B1-RJ006, 20B1-RJ006 (Note 1)

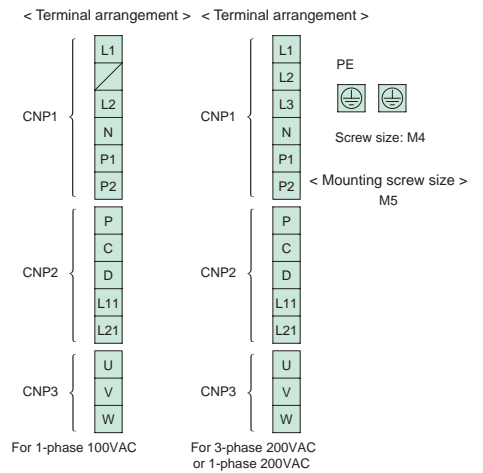
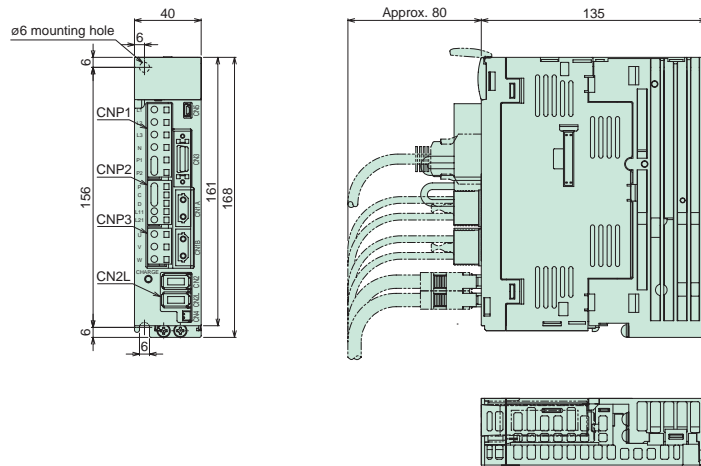

- MR-J3-40B-RJ006, 60B-RJ006, 40B1-RJ006 (Note 1)

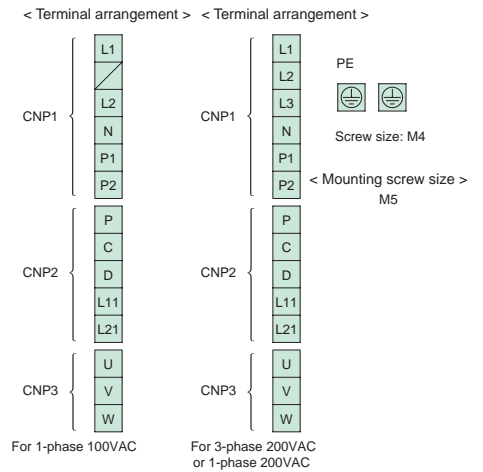
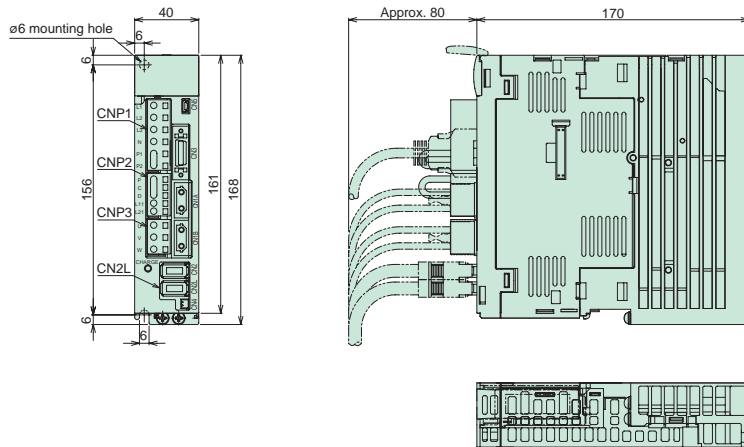

- MR-J3-70B-RJ006, 100B-RJ006 (Note 1)

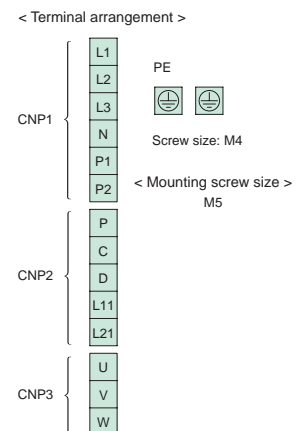
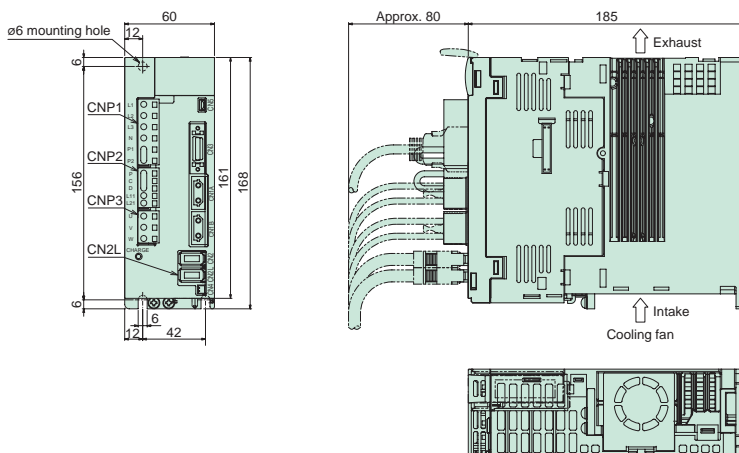

Notes: 1. CNP1, CNP2 and CNP3 connectors (insertion type) are supplied with the servo amplifier.

● MR-J3-60B4-RJ006, 100B4-RJ006 (Note 1)

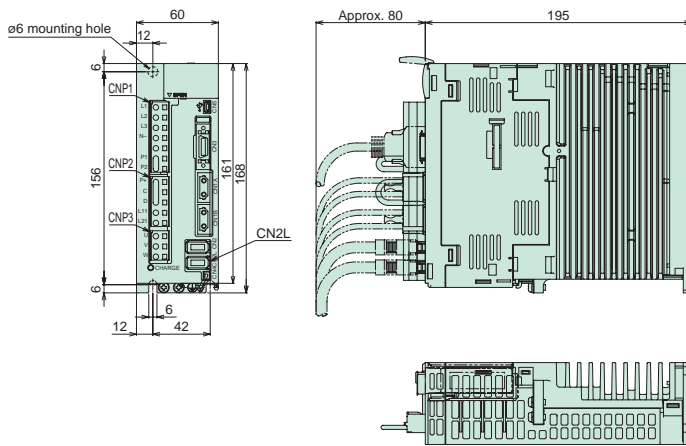

< Terminal arrangement >

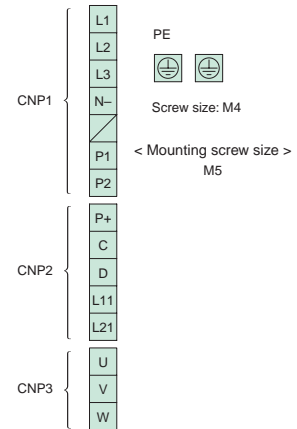

● MR-J3-200BN-RJ006*, 200B4-RJ006 (Note 1)

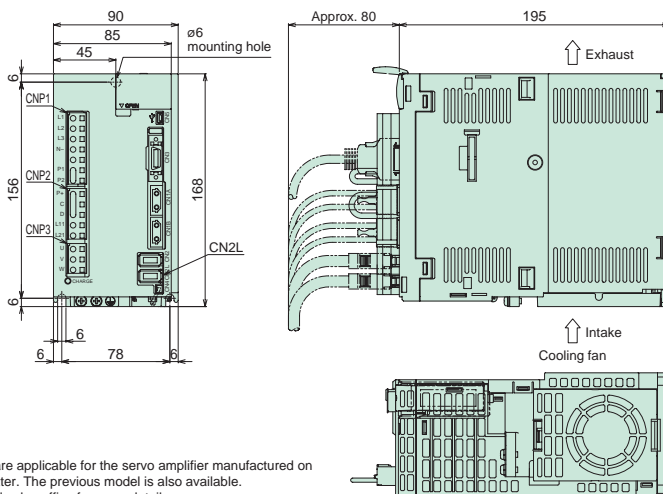

< Terminal arrangement >

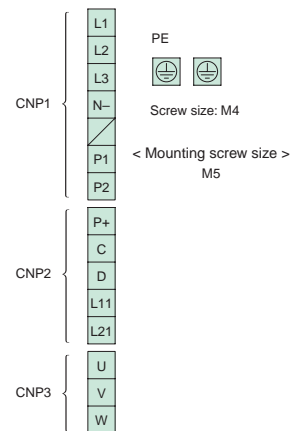

* The dimensions are applicable for the servo amplifier manufactured on August 2010 or later. The previous model is also available. Contact your local sales office for more details.

● MR-J3-350B-RJ006 (Note 1)

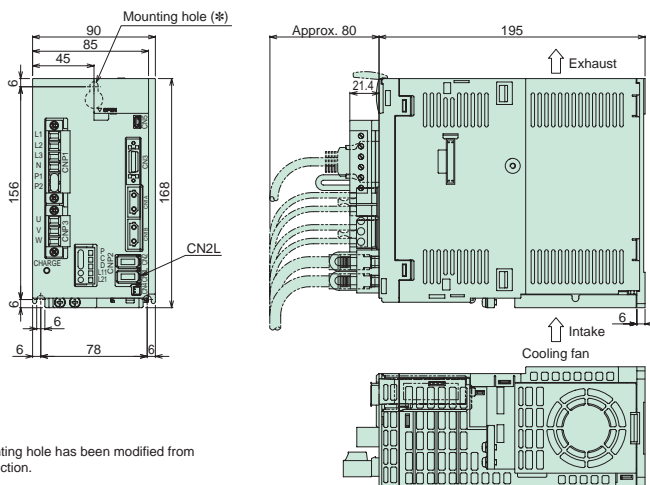

< Terminal arrangement >

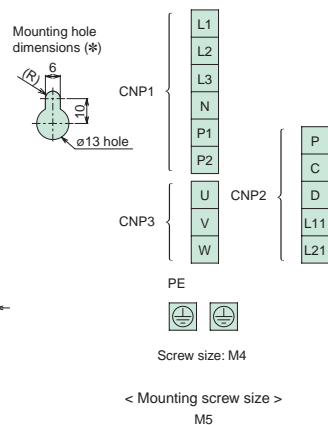

* The shape of the mounting hole has been modified from September 2010 production.

Notes: 1. CNP1, CNP2 and CNP3 connectors (insertion type) are supplied with the servo amplifier.

MELSERVO-J3

MR-J3-□B□-RJ006 Servo Amplifier Dimensions

(Unit: mm)

- MR-J3-500B-RJ006, 350B4-RJ006, 500B4-RJ006

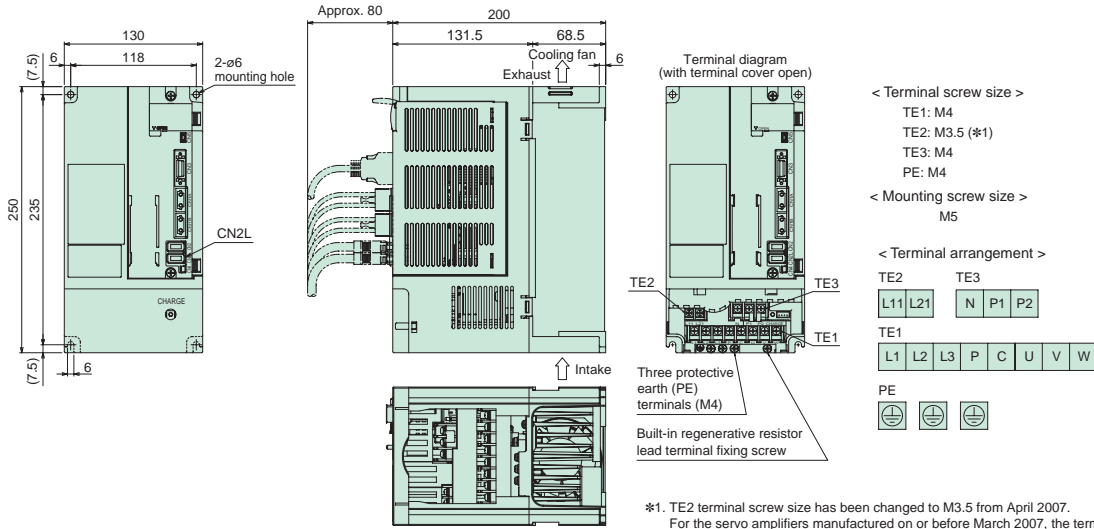

- MR-J3-700B-RJ006, 700B4-RJ006

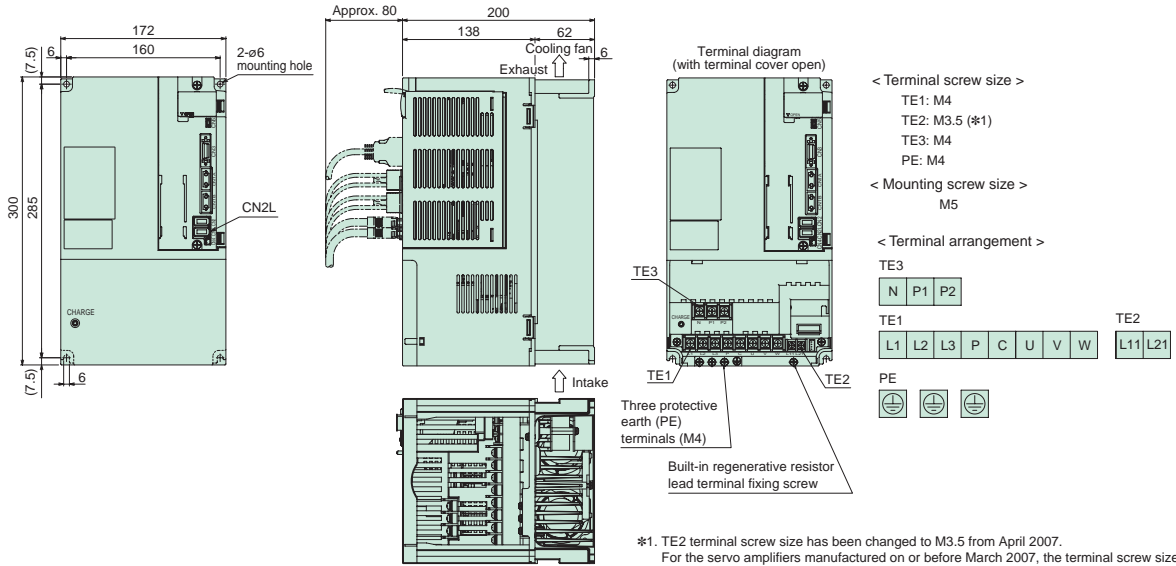

- MR-J3-11KB-RJ006 to 22KB-RJ006, 11KB4-RJ006 to 22KB4-RJ006

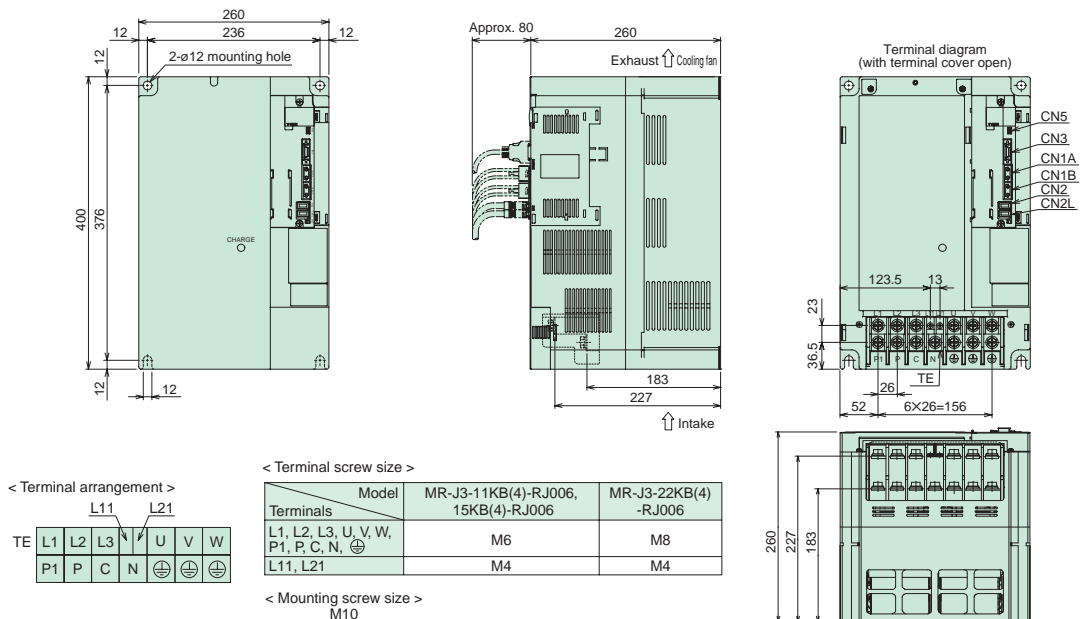

MR-J3-T: Connections with Peripheral Equipment (Note 1)

Peripheral equipment is connected to MR-J3-T as described below.

Connectors, options, and other necessary equipment are available so that users can set up MR-J3-T easily and start using it right away.

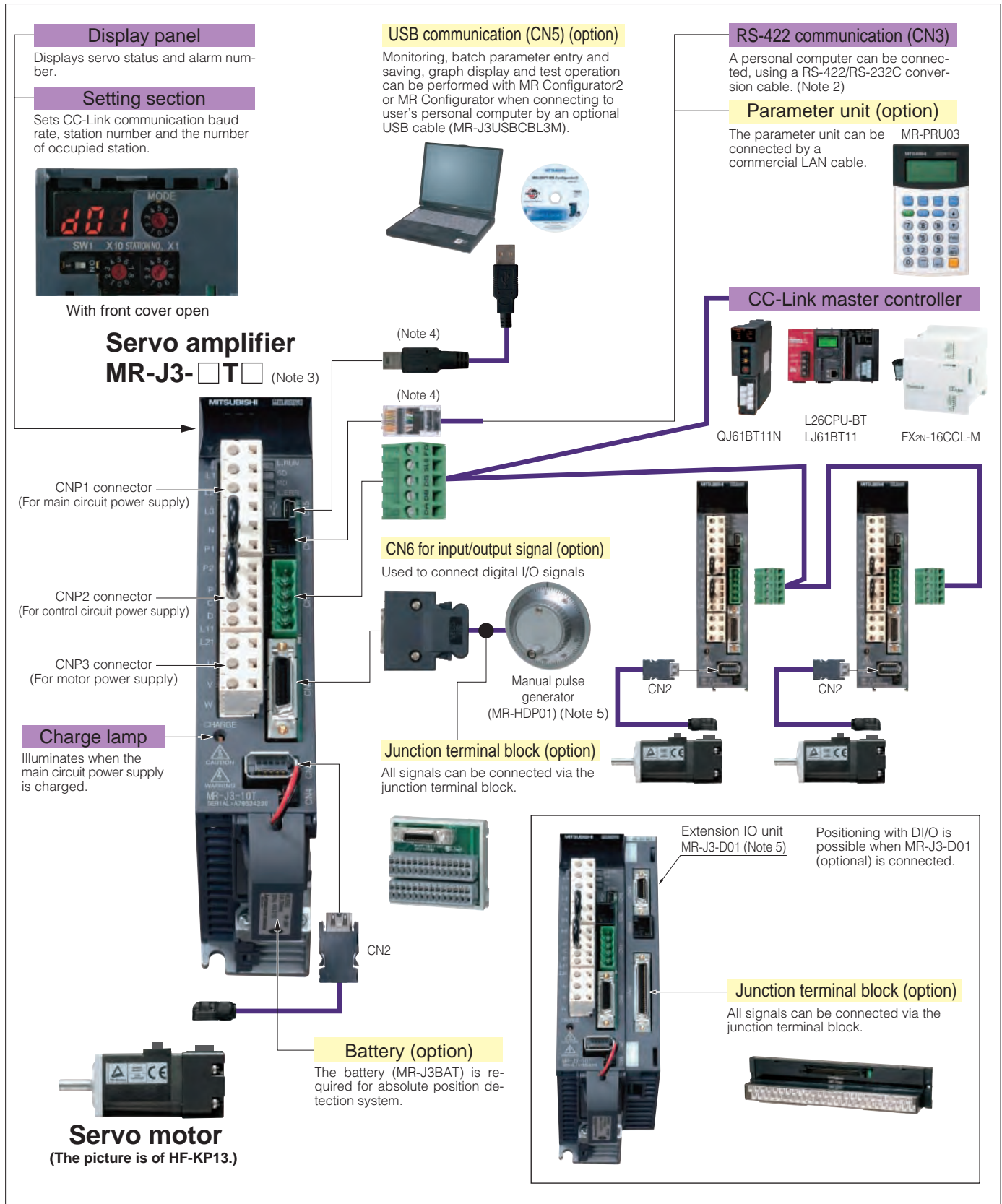

- Notes: 1. Refer to "MR-J3-□T SERVO AMPLIFIER INSTRUCTION MANUAL" for the actual connections.
- 2. A personal computer can be connected using a RS-422/RS-232C conversion cable (refer to the section "Ordering Information for Customers" in this catalog). In this case, some functions of MR Configurator2 and MR Configurator may be limited.
- 3. The connections with peripheral equipment shown above is for MR-J3-350T or smaller servo amplifier.
- 4. USB interface (CN5 connector) and RS-422 interface (CN3 connector) are mutually exclusive. They cannot be used at the same time.
- 5. The manual pulse generator and the extension IO unit cannot be used with indexer positioning or speed control operation.

MELSERVO-J3

Positioning operation can be performed just by setting position data (target positions), servo motor speeds, and acceleration/deceleration time constant, etc. in the point tables as if setting them in parameters. The AC servo can be used as the field network's drive source. This servo amplifier is the most appropriate when simplifying a system or configuring a simple positioning system without programs. In addition, easier operation with advanced functions is enabled by using MR Configurator2 or MR Configurator together with the servo amplifier.

Features: MR-J3-T (CC-Link Compatible Built-in Positioning Function)

- By using this servo amplifier with built-in positioning function, position and speed data, etc. can be set via CC-Link communication. (Applicable CC-Link version: Ver.1.10)
- Start, stop and monitor displays can be performed via CC-Link communication.
- Serial communication reduces wiring.
- CC-Link communication makes it possible to design the system with the servo amplifiers dispersed throughout.
- MR-PRU03 parameter unit (optional) enables easy parameter setting and operation monitoring.
- This servo amplifier is compatible with speed control operation. When two stations are occupied, speed command can be set directly with remote register.

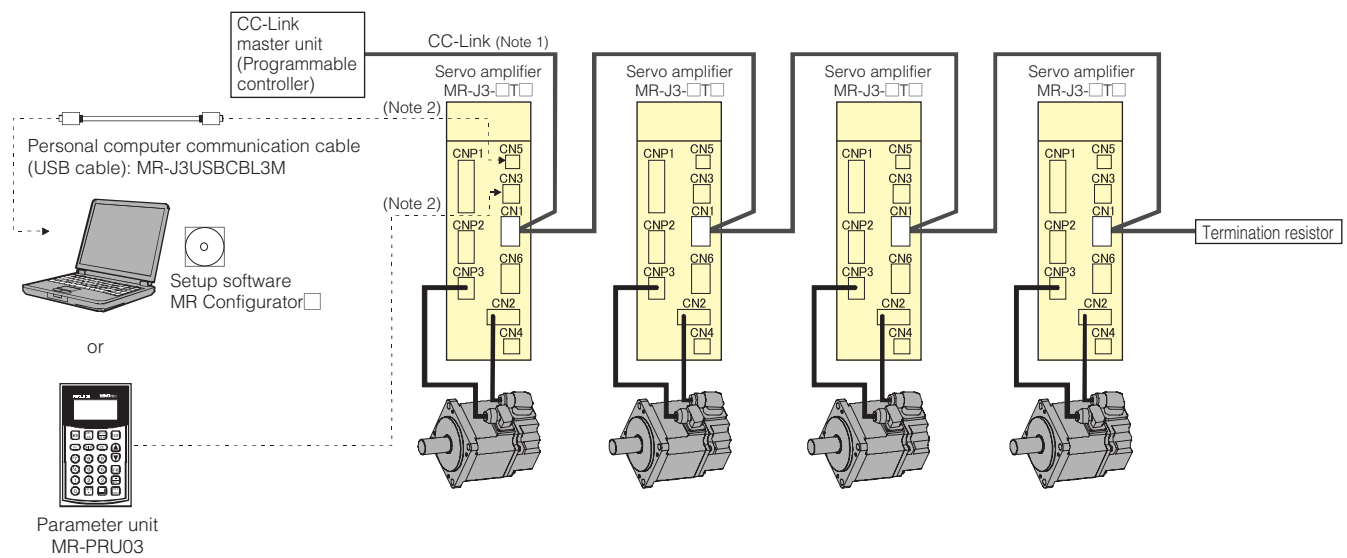

Notes: 1. When using only remote device stations, up to 42 servo amplifiers can be connected when 1 station is occupied by 1 servo amplifier, and up to 32 servo amplifiers when 2 stations are occupied by 1 servo amplifier.
 2. USB interface (CN5 connector) and RS-422 interface (CN3 connector) are mutually exclusive. They cannot be used at the same time.

Features: MR-J3-T+MR-J3-D01 (DI/O Command)

- Positioning with DI/O command is possible by using MR-J3-D01 extension IO unit (optional).
(Total digital input: 34 points. Total digital output: 19 points.)
- Up to 255 point tables can be used.

Simple positioning using DI/O (Note 2)

Positioning operation is performed with digital input/output signals.

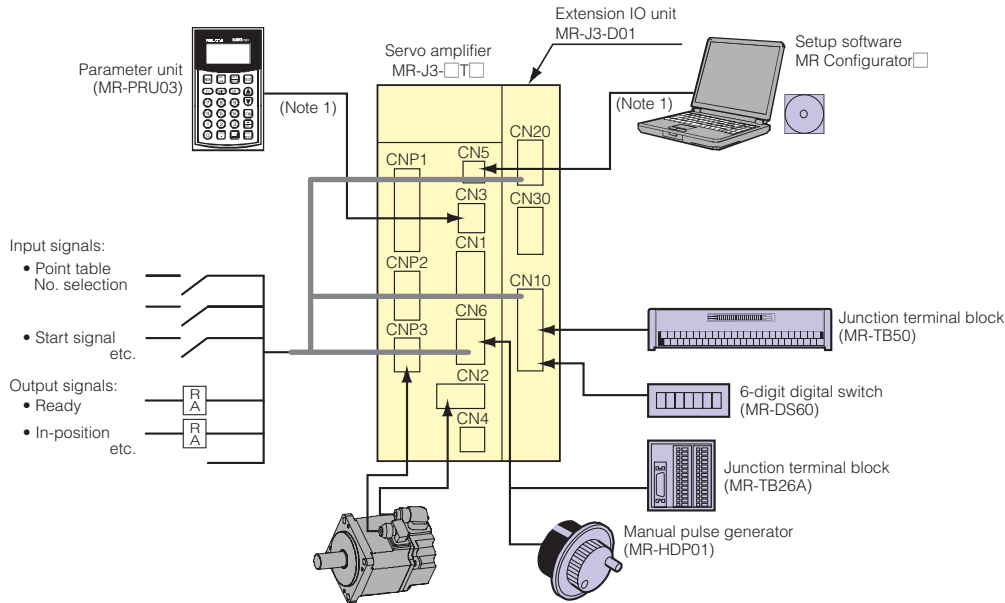

- Notes: 1. USB interface (CN5 connector) and RS-422 interface (CN3 connector) are mutually exclusive. They cannot be used at the same time.
2. MR-J3-D01 cannot be used with indexer positioning or speed control operation.

Serial Communication Operation

Positioning operation is performed by connecting servo amplifiers in the multi-drop configuration.

The RS-422 protocol communication specifications are disclosed, so the user can create a program.

Monitoring and parameter settings can be performed by MR Configurator2 or MR Configurator installed on a personal computer.

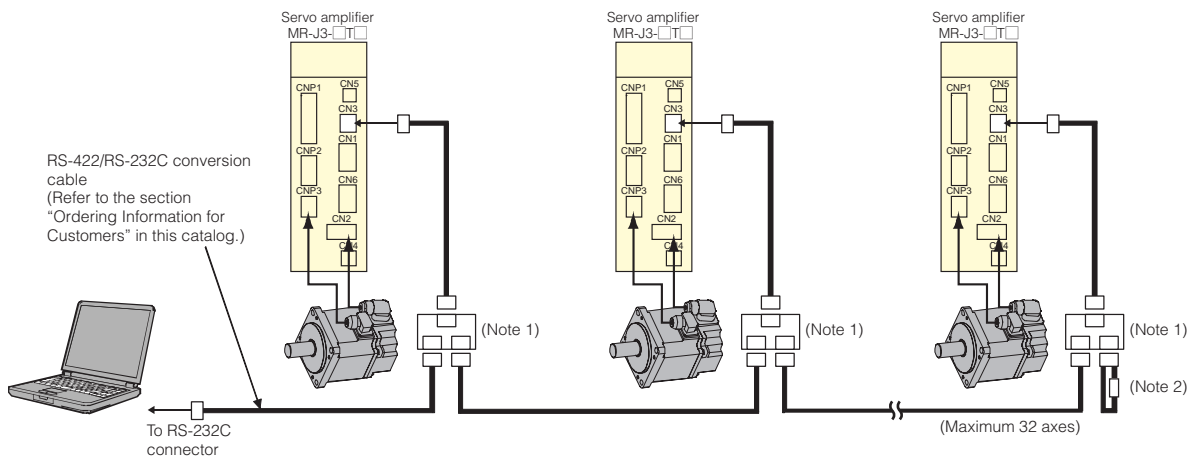

- Notes: 1. Branch connector, BMJ-8 (HACHIKO ELECTRIC CO., LTD) is recommended. Refer to the section "Ordering Information for Customers" in this catalog.
2. Connect a 150Ω termination resistor.

Communications specifications

The RS-422 (RS-232C) specifications are as follows.

- Baud rate : 9600, 19200, 38400, 57600 or 115200 asynchronous
- Transfer code : 1 start bit, 8 data bits, 1 parity bit (even number), 1 stop bit
- Transfer protocol : Character system, half-duplex communication method

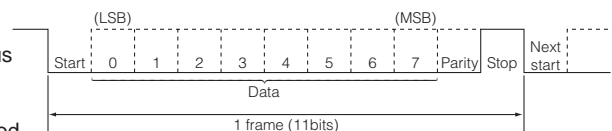

MR-J3-T Operational Functions

● Roll feed function

Capable of roll feeding operation (clear signal).
 Speed and acceleration/deceleration time constant, and override can be set.
 Position data can be set directly by remote register.

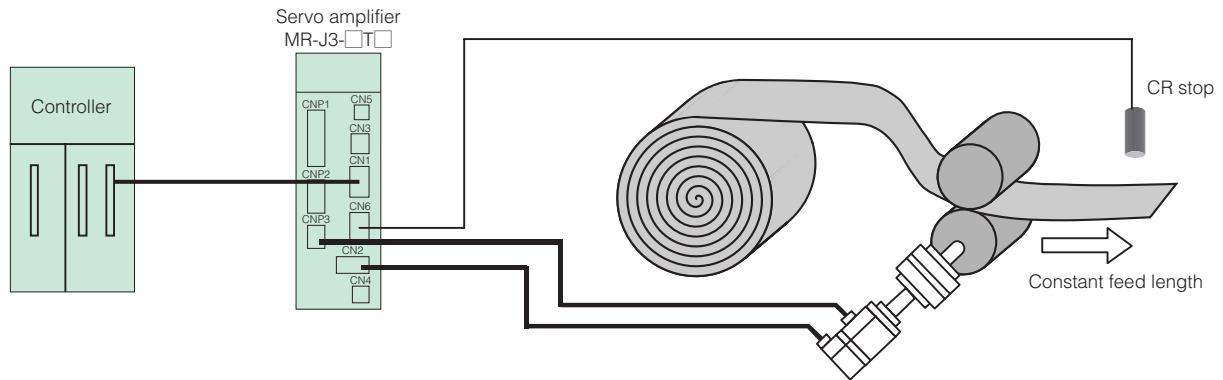

● Indexer positioning operation (Note 1)

Positioning is performed by specifying stations (maximum of 255 stations).
 Movement amount can be automatically calculated by setting the numbers of stations and gears on machine-side and motor-side in parameters.
 This function is available only with CC-Link communication.

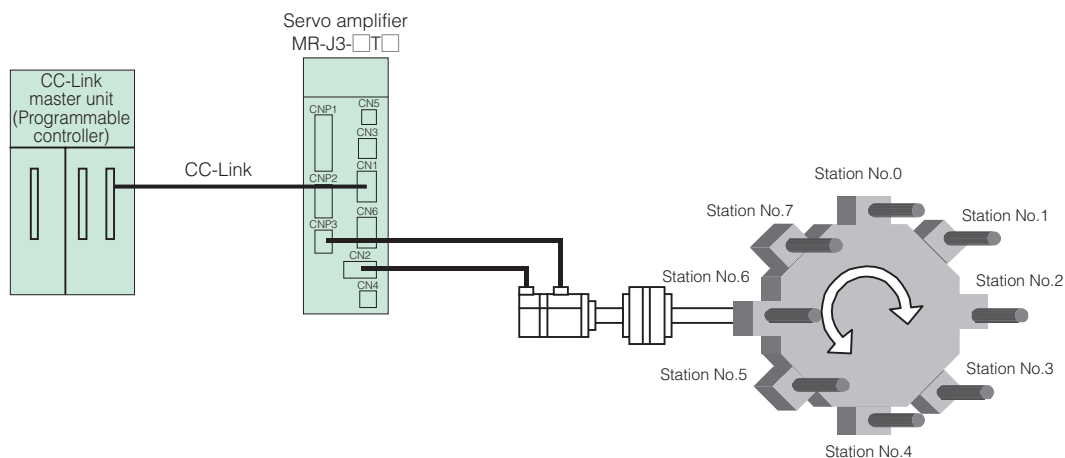

Notes: 1. Servo amplifier with software version A4 or above is required for the indexer positioning operation.

● Speed command operation (Note 1)

Speed command is set by designating servo motor speed in the point table No. 1 to 8 by the speed selection devices (SP0 to SP2).
 When two stations are occupied, speed command can be set directly with remote register.
 Acceleration/deceleration time constant is selected from the point table No.1 or 2 by the speed acceleration/deceleration selection device (STAB).
 This function is available only with CC-Link communication.

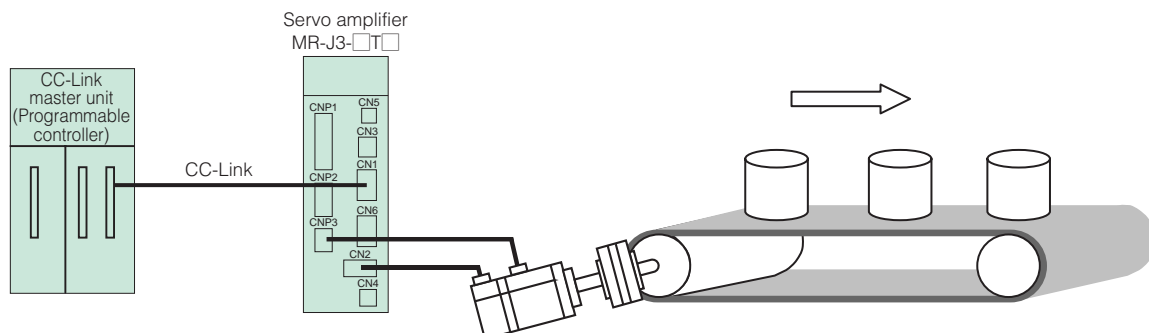

Notes: 1. Servo amplifier with software version A4 or above is required for the speed control operation.

MR-J3-T Positioning Command Method

The following two types of command methods are available.

Remote register (Note 1)	Sets position data and servo motor speed data directly in the remote register, and then executes positioning.
Point table No. input	Specifies position data and servo motor speed data set previously with the point table No., and then executes positioning.

Notes: 1. Setting range and description of position and servo motor speed data for the remote register are same as for the point table. Refer to the Point table below.

Point table: The following two types of point tables are available.

(1) Absolute value command method:

Moves to the address (absolute value) based on the home position.

Item	Setting range	Unit	Description
Position data	-999999 to 999999	$\times 10^{STM} \mu\text{m}$	<ul style="list-style-type: none"> • Absolute value command method Sets the address. STM is the ratio to the data. • Incremental value command method Sets the movement amount. STM is the ratio to the data.
Servo motor speed	0 to permissible	r/min	Sets the command speed for the servo motor used for positioning.
Acceleration time constant	0 to 20000	ms	Sets the acceleration time constant. (Note 2)
Deceleration time constant	0 to 20000	ms	Sets the deceleration time constant. (Note 2)
Dwell time	0 to 20000	ms	Runs the next point table after the set dwell time.
Auxiliary function	0 to 3	—	<ul style="list-style-type: none"> • Absolute value command method 0: Positions and stops (waits for start signal). 1: Continues operation for the next point table without stopping. • Incremental value command method 2: Positions and stops (waits for start signal). 3: Continues operation for the next point table without stopping.
M code (Note 1)	0 to 99	—	Sets output code when positioning completes.

(Example of setting point table data)

Point table No.	Position data	Servo motor speed	Acceleration time constant	Deceleration time constant	Dwell time	Auxiliary function	M code
1	1000	2000	200	200	0	1	1
2	2000	1600	100	100	0	0	2
:	:	:	:	:	:	:	:
255	3000	3000	100	100	0	2	99

If the point table No. 1's auxiliary function is 1 or 3, continuous positioning operation is carried out based on the point table as shown in the "●Auxiliary function 1 or 3" below.
If the point table No. 1's auxiliary function is 0 or 2, a start signal must be issued as shown in "●Auxiliary function 0 or 2" below.

●Auxiliary function 1 or 3

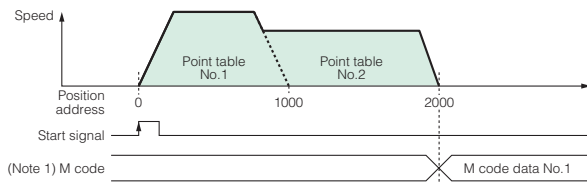

●Auxiliary function 0 or 2

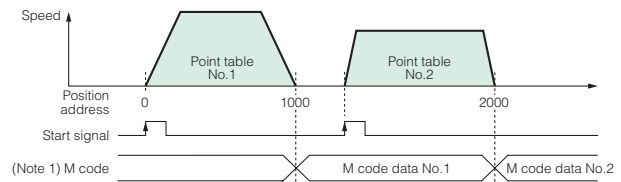

(2) Incremental value command method:

Moves from the current value according to the set position data

Item	Setting range	Unit	Description
Position data	0 to 999999	$\times 10^{STM} \mu\text{m}$	Sets the movement amount. STM is the ratio to the data.
Servo motor speed	0 to permissible	r/min	Sets the command speed for the servo motor used for positioning.
Acceleration time constant	0 to 20000	ms	Sets the acceleration time constant. (Note 2)
Deceleration time constant	0 to 20000	ms	Sets the deceleration time constant. (Note 2)
Dwell time	0 to 20000	ms	Runs the next point table after the set dwell time.
Auxiliary function	0 and 1	—	<ul style="list-style-type: none"> 0: Positions and stops (waits for start signal). 1: Continues operation for the next point table without stopping.
M code (Note 1)	0 to 99	—	Sets output code when positioning completes.

(Example of setting point table data)

Point table No.	Position data	Servo motor speed	Acceleration time constant	Deceleration time constant	Dwell time	Auxiliary function	M code
1	1000	2000	200	200	0	1	1
2	1000	1600	100	100	0	0	2
:	:	:	:	:	:	:	:
255	500	3000	100	100	0	0	99

If the point table No. 1's auxiliary function is 1, continuous positioning operation is carried out based on the point table as shown in the "●Auxiliary function 1" below.
If the point table No. 1's auxiliary function is 0, a start signal must be issued as shown in "●Auxiliary function 0" below.

●Auxiliary function 1

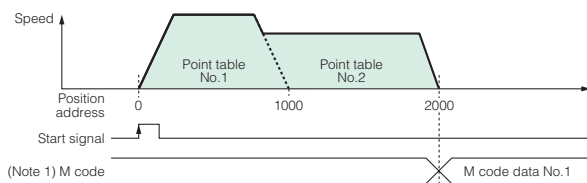

●Auxiliary function 0

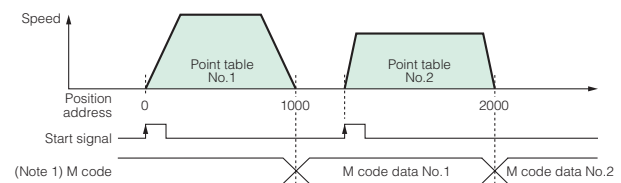

Notes: 1. When using M code, MR-J3-D01 extension IO unit (optional) is required. M code is digitally-output from MR-J3-D01. Remote output is not possible.

2. S-pattern acceleration/deceleration time constant is set by the servo amplifier's parameters.



MR-J3-T Servo Amplifier Specifications: 100VAC/200VAC

Servo amplifier model MR-J3-		10T	20T	40T	60T	70T	100T	200TN	350T	500T	700T	11KT	15KT	22KT	10T1	20T1	40T1	
Output	Rated voltage	3-phase 170VAC																
	Rated current (A)	1.1	1.5	2.8	3.2	5.8	6.0	11.0	17.0	28.0	37.0	68.0	87.0	126.0	1.1	1.5	2.8	
Main circuit power supply	Voltage/frequency (Note 1, 2)	3-phase 200 to 230VAC 50/60Hz or 1-phase 200 to 230VAC 50/60Hz (Note 10)					3-phase 200 to 230VAC 50/60Hz									1-phase 100 to 120VAC 50/60Hz		
	Rated current (A)	0.9	1.5	2.6	3.2	3.8	5.0	10.5	16.0	21.7	28.9	46.0	64.0	95.0	3.0	5.0	9.0	
	Permissible voltage fluctuation	For 3-phase 200 to 230VAC: 3-phase 170 to 253VAC For 1-phase 200 to 230VAC: 1-phase 170 to 253VAC (Note 10)					3-phase 170 to 253VAC									1-phase 85 to 132VAC		
	Permissible frequency fluctuation	±5% maximum																
Control circuit power supply	Voltage/frequency	1-phase 200 to 230VAC 50/60Hz (Note 10)					1-phase 200 to 230VAC 50/60Hz									1-phase 100 to 120VAC 50/60Hz		
	Rated current (A)	0.2					0.3					0.4						
	Permissible voltage fluctuation	1-phase 170 to 253VAC (Note 10)					1-phase 170 to 253VAC									1-phase 85 to 132VAC		
	Permissible frequency fluctuation	±5% maximum																
	Power consumption (W)	30					45					30						
Interface power supply		24VDC ±10% (required current capacity: 0.15A (Note 7))																
Tolerable regenerative power of regenerative resistor (W) (Note 3, 4)	Built-in regenerative resistor	—	10	10	10	20	20	100	100	130	170	—	—	—	—	10	10	
	External regenerative resistor (Standard accessory) (Note 5, 6)	—	—	—	—	—	—	—	—	—	—	500 (800)	850 (1300)	850 (1300)	—	—	—	
Control system		Sine-wave PWM control/current control system																
Dynamic brake		Built-in (Note 8, 11)										External option (Note 12)			Built-in (Note 8, 11)			
Safety features		Overcurrent shutdown, regeneration overvoltage shutdown, overload shutdown (electronic thermal), servo motor overheat protection, encoder fault protection, regeneration fault protection, undervoltage/sudden power outage protection, overspeed protection, excess error protection																
Structure (IP rating)		Natural-cooling open (IP00)					Fan cooling open (IP00)									Natural-cooling open (IP00)		
Environment	Ambient temperature (Note 9)	0 to 55°C (32 to 131°F) (non freezing), storage: -20 to 65°C (-4 to 149°F) (non freezing)																
	Ambient humidity	90% RH maximum (non condensing), storage: 90% RH maximum (non condensing)																
	Atmosphere	Indoors (no direct sunlight); no corrosive gas, inflammable gas, oil mist or dust																
	Elevation	1000m or less above sea level																
	Vibration	5.9m/s ² or less at 10 to 55Hz (directions of X, Y and Z axes)																
Mass (kg [lb])		0.8 (1.8)	0.8 (1.8)	1.0 (2.2)	1.0 (2.2)	1.4 (3.1)	1.4 (3.1)	2.1 (4.6)	2.3 (5.1)	4.6 (10)	6.2 (14)	18 (40)	18 (40)	19 (42)	0.8 (1.8)	0.8 (1.8)	1.0 (2.2)	

- Notes: 1. Rated output and speed of a servo motor are applicable when the servo amplifier, combined with the servo motor, is operated within the specified power supply voltage and frequency. Torque drops when the power supply voltage is below the specified value.
2. For torque characteristics when combined with a servo motor, refer to the section "Servo motor torque characteristics" in this catalog.
3. Optimal regenerative resistor varies for each system. Select the most suitable regenerative resistor by using the capacity selection software.
4. Refer to the section "Options ●Optional regeneration unit" in this catalog for the tolerable regenerative power (W).
5. Servo amplifiers without an enclosed regenerative resistor are also available. Refer to "Servo Amplifier Model Designation" in this catalog for details.
6. The value in () is applicable when the external regenerative resistors, GRZG400-□Ω (standard accessory) are used with cooling fans (2 units of 92 X 92mm, minimum air flow: 1.0m³/min). Note that change in parameter No. PA02 is required.
7. 0.15A is the value when all of the input/output points are used. The current capacity can be stepped down according to the number of input/output points in use. Refer to "MR-J3-□T SERVO AMPLIFIER INSTRUCTION MANUAL" for details.
8. Special specification servo amplifiers without a dynamic brake are also available: MR-J3-□T(1)-ED. When using the servo amplifier without a dynamic brake, the servo motor does not stop immediately at alarm occurrence or power failure. Take measures to ensure safety on the entire system.
9. MR-J3-350T or smaller servo amplifiers can be mounted closely. In this case, operate them at the ambient temperature of 0 to 45°C (32 to 113°F) or at 75% or less of the effective load ratio.
10. Special specification servo amplifiers for 1-phase 200 to 240VAC are also available: MR-J3-□T-U004. The permissible voltage fluctuation for MR-J3-□T-U004 is 1-phase 170 to 264VAC.
11. When using the built-in dynamic brake, refer to "MR-J3-□T SERVO AMPLIFIER INSTRUCTION MANUAL" for the permissible load to motor inertia moment ratio.
12. Use an optional external dynamic brake with the servo amplifier. Without the external dynamic brake, a servo motor does not stop immediately at emergency stop and falls in free-run status, causing an accident such as machine collision, etc. Take measures to ensure safety on the entire system.



MR-J3-T Servo Amplifier Specifications: 400VAC

Servo amplifier model MR-J3-		60T4	100T4	200T4	350T4	500T4	700T4	11KT4	15KT4	22KT4
Output	Rated voltage	3-phase 323VAC								
	Rated current (A)	1.5	2.8	5.4	8.6	14.0	17.0	32.0	41.0	63.0
Main circuit power supply	Voltage/frequency (Note 1, 2)	3-phase 380 to 480VAC 50/60Hz								
	Rated current (A)	1.4	2.5	5.1	7.9	10.8	14.4	23.1	31.8	47.6
	Permissible voltage fluctuation	3-phase 323 to 528VAC								
	Permissible frequency fluctuation	±5% maximum								
Control circuit power supply	Voltage/frequency	1-phase 380 to 480VAC 50/60Hz								
	Rated current (A)	0.1			0.2					
	Permissible voltage fluctuation	1-phase 323 to 528VAC								
	Permissible frequency fluctuation	±5% maximum								
Power consumption (W)		30			45					
Interface power supply		24VDC ±10% (required current capacity: 0.15A (Note 7))								
Tolerable regenerative power of regenerative resistor (W) (Note 3, 4)	Built-in regenerative resistor	15	15	100	100	130 (Note 9)	170 (Note 9)	—	—	—
	External regenerative resistor (Standard accessory) (Note 5, 6)	—	—	—	—	—	—	500 (800)	850 (1300)	850 (1300)
Control system		Sine-wave PWM control/current control system								
Dynamic brake		Built-in (Note 8, 10)					External option (Note 11)			
Safety features		Overcurrent shutdown, regeneration overvoltage shutdown, overload shutdown (electronic thermal), servo motor overheat protection, encoder fault protection, regeneration fault protection, undervoltage/sudden power outage protection, overspeed protection, excess error protection								
Structure (IP rating)		Natural-cooling open (IP00)			Fan cooling open (IP00)					
Environment	Ambient temperature	0 to 55°C (32 to 131°F) (non freezing), storage: -20 to 65°C (-4 to 149°F) (non freezing)								
	Ambient humidity	90% RH maximum (non condensing), storage: 90% RH maximum (non condensing)								
	Atmosphere	Indoors (no direct sunlight); no corrosive gas, inflammable gas, oil mist or dust								
	Elevation	1000m or less above sea level								
Vibration		5.9m/s ² or less at 10 to 55Hz (directions of X, Y and Z axes)								
Mass (kg [lb])		1.7 (3.7)	1.7 (3.7)	2.1 (4.6)	4.6 (10)	4.6 (10)	6.2 (14)	18 (40)	18 (40)	19 (42)

- Notes: 1. Rated output and speed of a servo motor are applicable when the servo amplifier, combined with the servo motor, is operated within the specified power supply voltage and frequency. Torque drops when the power supply voltage is below the specified value.
2. For torque characteristics when combined with a servo motor, refer to the section "Servo motor torque characteristics" in this catalog.
3. Optimal regenerative resistor varies for each system. Select the most suitable regenerative resistor by using the capacity selection software.
4. Refer to the section "Options ●Optional regeneration unit" in this catalog for the tolerable regenerative power (W).
5. Servo amplifiers without an enclosed regenerative resistor are also available. Refer to "Servo Amplifier Model Designation" in this catalog for details.
6. The value in () is applicable when the external regenerative resistors, GRZG400-□Ω (standard accessory) are used with cooling fans (2 units of 92 X 92mm, minimum air flow: 1.0m³/min). Note that change in parameter No. PA02 is required.
7. 0.15A is the value when all of the input/output points are used. The current capacity can be stepped down according to the number of input/output points in use. Refer to "MR-J3-□T SERVO AMPLIFIER INSTRUCTION MANUAL" for details.
8. Special specification servo amplifiers without a dynamic brake are also available: MR-J3-□T4-ED. When using the servo amplifier without a dynamic brake, the servo motor does not stop immediately at alarm occurrence or power failure. Take measures to ensure safety on the entire system.
9. The servo amplifier built-in regenerative resistor is compatible with the maximum torque deceleration when the motor is used within the rated speed and the recommended load to motor inertia moment ratio. Contact your local sales office if the operating motor speed and the load to motor inertia moment ratio exceed the rated speed and the recommended ratio.
10. When using the built-in dynamic brake, refer to "MR-J3-□T SERVO AMPLIFIER INSTRUCTION MANUAL" for the permissible load to motor inertia moment ratio.
11. Use an optional external dynamic brake with the servo amplifier. Without the external dynamic brake, a servo motor does not stop immediately at emergency stop and falls in free-run status, causing an accident such as machine collision, etc. Take measures to ensure safety on the entire system.

Model designation

Servo motors

Servo amplifiers

Options

Peripheral equipment

MR-J3-B Safety

MR-J3W series

Servo support software

Cautions

Warranty

Global FA centers



MR-J3-T Command and Operation Mode (Point Table and Indexer)

Item		Description			
Command interface		CC-Link communication (Ver.1.10), DIO command (extension IO unit MR-J3-D01 is required), or RS-422 communication			
Operation system	Point table	Remote register	Possible with CC-Link communication when 2 stations occupied. Position command input: position command data is set with the remote register. Feed length input setting range: $\pm 1\mu\text{m} \sim \pm 999999 \times 10^{\text{STM}}\text{mm}$ (Note 3). Speed command input: speed command data (rotating speed) is set with the remote register.		
		Point table No. input	Possible with CC-Link communication, DIO command or RS-422 communication CC-Link communication (when 1 station occupied): 31 points CC-Link communication (when 2 stations occupied): 255 points DIO command: 255 points (extension IO unit MR-J3-D01 is required.) RS-422 communication: 255 points Position command input: sets from the point table. 1-point feed length setting range: $\pm 1\mu\text{m} \sim \pm 999999 \times 10^{\text{STM}}\text{mm}$ (Note 3). Speed command input: sets speed and acceleration/deceleration time constant from the point table.		
		Automatic operation mode	Point table	Point table No. input or point table data input system. Each positioning operation based on position and speed data. Speed changing operation (2 to 255 speeds). Automatic continuous positioning operation (2 to 255 points) Roll feed display is selectable. Clearing droop pulses with the clear (CR) signal is selectable.	
	Manual operation mode	JOG operation	Inches upon contact input, CC-Link communication or RS-422 communication based on speed data set by a parameter.		
		Manual pulse generator	Manual feed with the manual pulse generator. Command pulse multiplication: X1, X10, X100 is selectable with parameter.		
	Indexer (Note 1)	Command method	Station position command input	Possible with CC-Link communication CC-Link communication (when 1 station occupied): 31 stations CC-Link communication (when 2 stations occupied): 255 stations	
			Speed command input	Remote register	Possible with CC-Link communication when 2 stations occupied. Sets speed command data (rotating speed) with the remote register.
				Speed No. input	Selects speed and acceleration/deceleration time constant from the point table. (only when 2 stations occupied)
		Automatic operation mode	Rotating direction specified	Positions to the specified station. Rotating direction is selectable.	
			Shortest rotating direction	Positions to the specified station. Shorter rotating direction from the current point is selected.	
Manual operation mode		Indexer JOG operation	Rotates in a direction specified by rotating direction evaluation when the start signal (RYn1) turns ON. Positions to a nearest station where deceleration to a stop is possible when the start signal (RYn1) turns OFF.		
	JOG operation	Inches upon CC-Link communication based on speed data set by a parameter.			
Home position return mode	Dog type		Returns to home position upon Z-phase pulse count after passing through proximity dog. Direction for return to home position selectable. Home position shift amount and home position address selectable. Automatic retreat on dog back to home position and automatic stroke retreat function.		
	Count type		Returns to home position upon Z-phase pulse count after touching proximity dog and traveling predetermined amount. Direction for return to home position selectable. Home position shift amount and home position address selectable. Automatic retreat on dog back to home position and automatic stroke retreat function.		
	Data set type		Returns to home position without dog. Sets any position as home position using JOG operation, etc. Home position address selectable.		
	Stopper type		Returns to home position upon hitting end of stroke. Direction for return to home position selectable. Home position address selectable.		
	Ignore home (Servo-on position as home position)		Uses position where the servo on (SON) signal turns ON as home position. Home position address selectable.		
	Dog type rear end reference		Returns to home position with respect to the rear end of a proximity dog. Direction for return to home position selectable. Home position shift amount and home position address selectable. Automatic retreat on dog back to home position and automatic stroke retreat function.		
	Count type front end reference		Returns to home position with respect to the front end of a proximity dog. Direction for return to home position selectable. Home position shift amount and home position address selectable. Automatic retreat on dog back to home position and automatic stroke retreat function.		
	Dog cradle type		Returns to home position upon the first Z-phase pulse with respect to the front end of a proximity dog. Direction for return to home position selectable. Home position shift amount and home position address selectable. Automatic retreat on dog back to home position and automatic stroke retreat function.		
	Dog type adjacent Z-phase reference		Returns to home position upon the Z-phase pulse right before a proximity dog with respect to the front end of a proximity dog. Direction for return to home position selectable. Home position shift amount and home position address selectable. Automatic retreat on dog back to home position and automatic stroke retreat function.		
	Dog type front end reference		Returns to home position to the front end of a point dog with respect to the front end of a proximity dog. Direction for return to home position selectable. Home position shift amount and home position address selectable. Automatic retreat on dog back to home position and automatic stroke retreat function.		
	Dog less Z-phase reference		Returns to home position to the first Z-phase pulse with respect to the first Z-phase pulse. Direction for return to home position selectable. Home position shift amount and home position address selectable		
	Torque limit changing dog type (Note 2)		Returns to home position upon Z-phase pulse count after passing through proximity dog. Direction for return to home position selectable. Home position shift amount and home position address selectable. Automatic retreat on dog back to home position and automatic stroke retreat function. Torque limit automatic switching function.		
	Torque limit changing data set type (Note 2)		Returns to home position without dog. Sets any position as home position. Home position address selectable. Torque limit automatic switching function.		
Automatic positioning to home position function		High-speed automatic positioning to a defined home position			

Notes: 1. Servo amplifier with software version A4 or above is required for the indexer positioning operation.
2. This mode is available only with the indexer positioning operation.
3. STM is the ratio for the data. It can be changed by parameter.

MR-J3-T Command and Operation Mode (Speed Control Operation)

Item		Description
Speed control operation (Note 1)	Command method	Remote register Possible with CC-Link communication (when 2 stations occupied). Selects speed and acceleration/deceleration time constant in the point table. Acceleration/deceleration time constant: 2 points
		Speed No. input Possible with CC-Link communication. Selects acceleration/deceleration time constant in the point table. Speed command: 8 speeds Acceleration/deceleration time constant: 2 points
	Speed command data setting range	When setting in unit of 1 [r/min]: 0 to servo motor's permissible speed [r/min] When setting in unit of 0.1 [r/min]: 0 to servo motor's permissible speed [r/min], or 0 to 6553.5 [r/min] (Note 2)

Notes:1. Servo amplifier with software version A4 or above is required for the speed control operation.

2. When using a servo motor with the instantaneous permissible speed of 6553.5 [r/min] or faster, the maximum setting value is limited to 6553.5[r/min].

MR-J3-D01 Specifications

Item		Description
Model		MR-J3-D01
Power supply for interface		24VDC ±10% (required current capacity: 0.8A (Note 1, 2))
Digital input		30 points, photocoupler insulation, sink/source compatible
Digital output		16 points, photocoupler insulation, sink/source compatible
Analog input		2ch, 0 to ±10VDC (input impedance: 10 to 12kΩ)
Analog output		2ch, 0 to ±12VDC
Power supply for analog input signal		P15R: DC+15V, permissible current: 30mA N12R: DC-12V, permissible current: 30mA (Note 5)
Structure (IP rating)		Natural-cooling open (IP00)
Environment	Ambient temperature	0 to 55°C (32 to 131°F) (non freezing), storage: -20 to 65°C (-4 to 149°F) (non freezing)
	Ambient humidity	90% RH maximum (non condensing), storage: 90% RH maximum (non condensing)
	Atmosphere	Indoors (no direct sunlight); no corrosive gas, inflammable gas, oil mist or dust
	Elevation	1000m or less above sea level
	Vibration	5.9m/s ² or less at 10 to 55Hz (directions of X, Y and Z axes)
Mass (g [lb])		140 (0.31)

Functions connecting to MR-J3-□T□ (Note 7)

Function		Description
Digital input		Point table No. selection 1 to 8 (DI0 to DI7), Servo on (SON), Reset (RES), External torque limit selection (TL), Internal torque limit selection (TL1), Manual pulse generator multiplication 1 and 2 (TP0 and TP1), Override selection (OVR), Automatic/manual selection (MD0), Temporary stop/restart (TSTP), Proportional control (PC), Forward rotation start (ST1), Reverse rotation start (ST2), Position data input 1 to 12 (POS00 to POS03, POS10 to POS13, POS20 to POS23), Position data input symbol+ (POSP), Clear (CR), Position data input symbol- (POSN), Strobe (STRB), Speed selection 1 to 3 (SP0 to SP2), Gain changing (CDP) (Note3)
Digital output		Alarm code (ACD0 to ACD3), M code (MCD00 to MCD03, MCD10 to MCD13), Temporary stop (PUS), Positioning complete (MEND), Rough match (CPO), In-position (INP), Position data request 1 and 2 (PRQ1 and PRQ2), Zero speed detection (ZSP), Torque limit in effect (TLC), Warning (WNG), Electromagnetic brake interlock (MBR), Dynamic brake interlock (DB), Battery warning (BWNG), Positioning range output (POT), Variable gain selection (CDPS), Command speed reached (SA), Point table No. output 1 to 8 (PT0 to PT7) (Note3)
Analog input		Override (VC) (-10 to +10VDC/0 to 200%) Analog torque limit (TLA) (0 to ±10VDC/maximum torque)
Analog output		Analog monitor output (MO1 and MO2) (Note 4)

Functions connecting to MR-J3-□A□-RJ040 (Note 6)

Function		Description
Position control mode	Electric gear numerator digital input	The electric gear numerator can be set arbitrarily in 5-digit BCD or 16-bit binary.
	High resolution analog torque limit	The torque limit can be set according to the rotating direction. TLAP: 0 to +10VDC/maximum torque, resolution: 12-bit (Standard: 10-bit) TLAN: 0 to -10VDC/maximum torque, resolution: 12-bit (Standard: 10-bit)
Speed control mode	Digital speed command input	The speed command can be set arbitrarily in 5-digit BCD or 12-bit (or settable in 16-bit) binary.
	High resolution analog torque limit	The torque limit can be set according to the rotating direction. TLAP: 0 to +10VDC/maximum torque, resolution: 16-bit (Standard: 14-bit) TLAN: 0 to -10VDC/maximum torque, resolution: 16-bit (Standard: 14-bit)
Torque control mode	Digital speed limit input	The speed limit can be set arbitrarily in 5-digit BCD or 12-bit (or settable in 16-bit) binary.
	High resolution torque command input	External analog torque command (OTC) 0 to ±8VDC/maximum torque, resolution: 12-bit (Standard: 10-bit)

Notes:1. 0.8A is the value when all of the input/output points are used. The current capacity can be stepped down according to the number of input/output points in use. Refer to "MR-J3-□T MR-J3-D01 SERVO AMPLIFIER INSTRUCTION MANUAL" for details.

2. A 24VDC power supply for input/output signals can be shared by the servo amplifier and MR-J3-D01. In this case, secure the power supply capacity corresponding to the points of the input/output signals to be used.

3. Signal assignment can be changed by setting parameters. Refer to "MR-J3-□T MR-J3-D01 SERVO AMPLIFIER INSTRUCTION MANUAL" for details.

4. Analog monitor output can be selected by setting parameter. Refer to "MR-J3-□T MR-J3-D01 SERVO AMPLIFIER INSTRUCTION MANUAL" for details.

5. P15R can be used as a power supply for TLA and VC. N12R can be used as a power supply for VC. Note that the power voltage varies between -12V to -15V.

6. MR-J3-□A□-RJ040 is available for 100V, 200V 22kW or smaller, and 400V 11kW to 22kW.

7. MR-J3-D01 cannot be used with indexer positioning or speed control operation.

MELSERVO-J3

Extension IO Unit Dimensions

(Unit: mm)

● MR-J3-D01

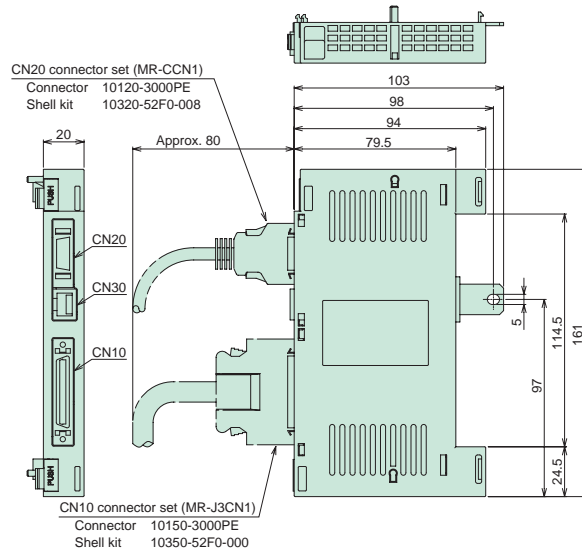

● Dimensions when MR-J3-D01 is installed

- 100V/200V 0.1kW to 3.5kW
- 400V 0.6kW to 2kW

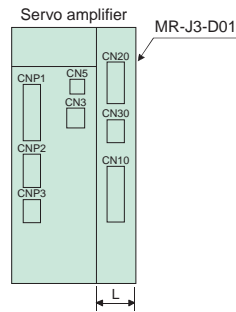

- 200V 5kW, 7kW
- 400V 3.5kW to 7kW

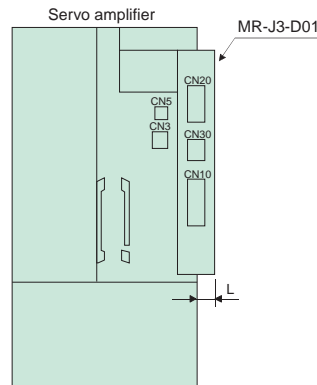

Servo amplifier model	Variable dimension
	L
MR-J3-10T(1) to 100T(4) MR-J3-10A(1)-RJ040 to 100A-RJ040	20
MR-J3-200TN, 200T4, 350T MR-J3-200AN-RJ040, 350A-RJ040	15
MR-J3-350T4, 500T(4), 700T(4) MR-J3-500A-RJ040, 700A-RJ040	10

Note: For servo amplifier 200V/400V 11kW to 22kW, MR-J3-D01 will be built into the servo amplifier.

MR-J3-□T□ Standard Wiring Diagram

● Connection example

Main circuit/control circuit power supply connection

The connection differs according to the power voltage.
 →Refer to the main/control circuit power supply connection examples (1) to (6).

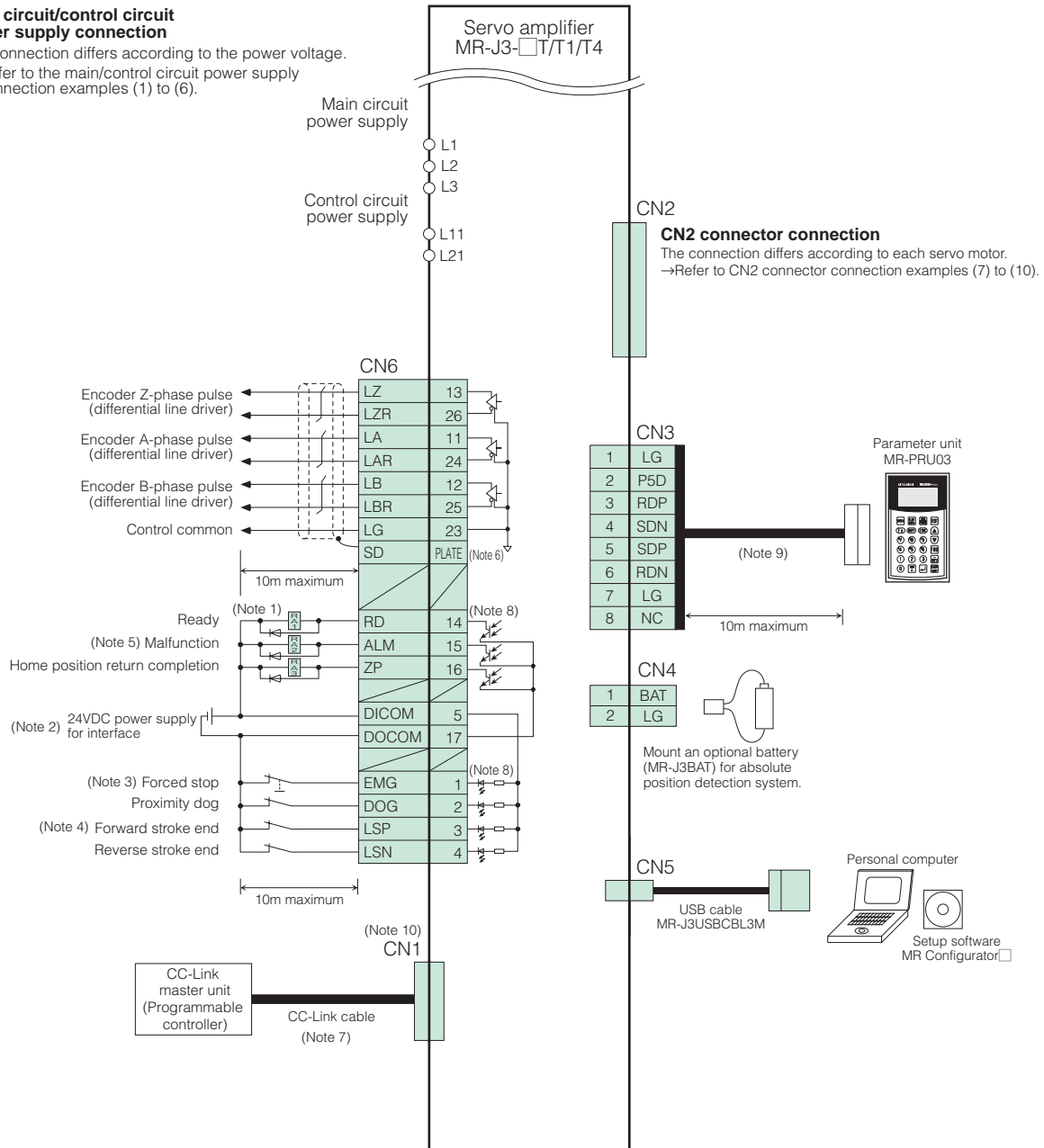

Notes:

- Do not reverse the diode's direction. Connecting it backwards may cause the servo amplifier to malfunction such that the signals are not output, and the forced stop and other safety circuits are inoperable.
- Use the power supply 24VDC±10% (required current capacity: 0.15A). 0.15A is the value when all of the input/output points are used. Note that the current capacity can be stepped down according to the number of input/output points in use. Refer to "MR-J3-□T SERVO AMPLIFIER INSTRUCTION MANUAL" for details.
- Turn on the forced stop (EMG) signal (normally closed contact) before starting the operation, or cancel the forced stop signal by parameter No. PD01.
- Close the forward and reverse stroke end (LSP, LSN) signals (normally closed contact) or turn on the forward and reverse stroke end signals by parameter No. PD01 before starting the operation.
- The malfunction (ALM) signal (normally closed contact) is conducted to DOCOM in normal alarm-free condition.
- Connect the shield wire securely to the plate inside the connector (ground plate).
- For the CC-Link cable, refer to the section "Ordering Information for Customers" in this catalog for details.
- This is for sink wiring. Source wiring is also possible. Refer to "MR-J3-□T SERVO AMPLIFIER INSTRUCTION MANUAL" for details.
- Use a commercial LAN cable (EIA568 compliant). A personal computer can be connected using a RS-422/RS-232C conversion cable. Note that USB interface (CN5 connector) and RS-422 interface (CN3 connector) are mutually exclusive. They cannot be used at the same time. Refer to the section "Ordering Information for Customers" in this catalog for the RS-422/RS-232C conversion cable.
- CN1 connector is used only when operated with CC-Link communication. Manufacture a CC-Link cable that fits to a CN1 connector supplied with the servo amplifier.

MR-J3-D01 (Optional) Standard Wiring Diagram

● Connection example (Point table positioning operation)

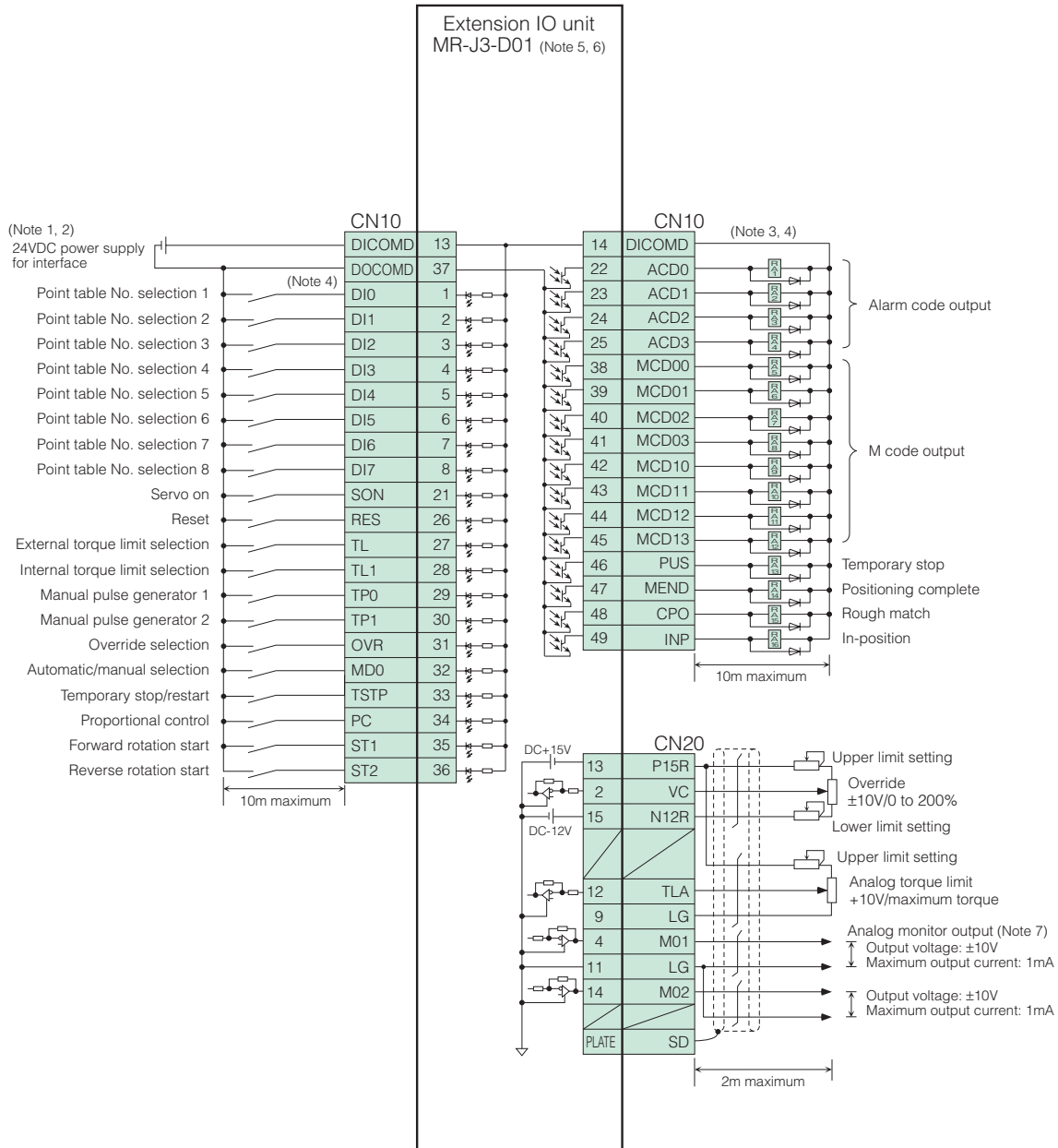

Notes:

1. Use the power supply 24VDC±10% (required current capacity: 0.8A). 0.8A is the value when all of the input/output points are used. Note that the current capacity can be stepped down according to the number of input/output points in use. Refer to "MR-J3-□□ MR-J3-D01 SERVO AMPLIFIER INSTRUCTION MANUAL" for details.
2. A 24VDC power supply for input/output signals can be shared by the servo amplifier and MR-J3-D01. In this case, secure the power supply capacity corresponding to the points of the input/output signals to be used.
3. Do not reverse the diode's direction. Connecting it backwards may cause the servo amplifier and/or MR-J3-D01 to malfunction such that the signals are not output, and the forced stop and other safety circuits are inoperable.
4. This is for sink wiring. Source wiring is also possible. Refer to "MR-J3-□□ MR-J3-D01 SERVO AMPLIFIER INSTRUCTION MANUAL" for details.
5. MR-J3-D01 connects directly to CN7 connector of the servo amplifier, MR-J3-□□□ or MR-J3-□□□-RJ040.
6. MR-J3-D01 is not available with the indexer positioning operation.
7. Output voltage range varies depending on the monitored signal.

MR-J3-□T□ Servo Amplifier Dimensions

(Unit: mm)

● MR-J3-10T, 20T, 10T1, 20T1 (Note 1)

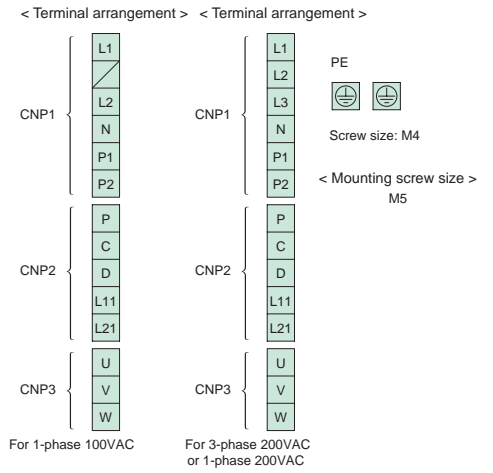
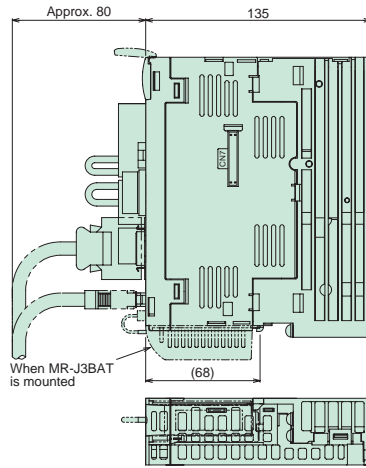
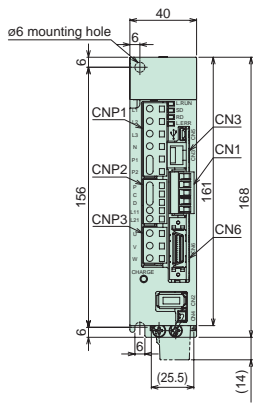

● MR-J3-40T, 60T, 40T1 (Note 1)

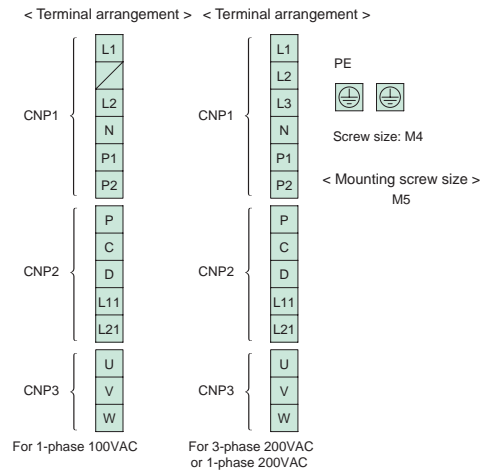
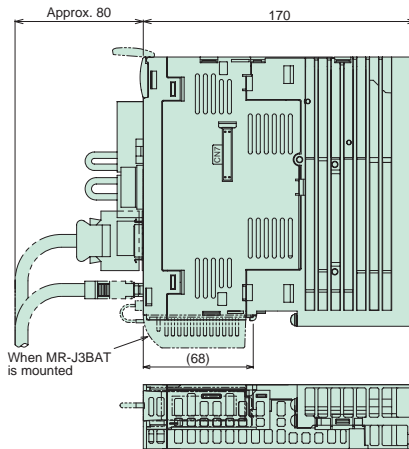
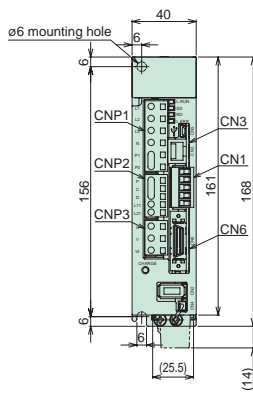

● MR-J3-70T, 100T (Note 1)

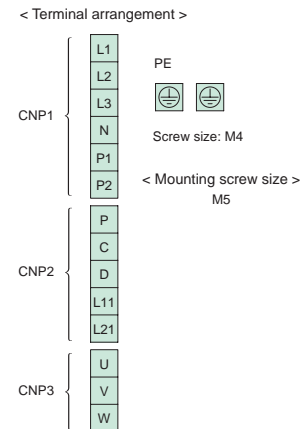
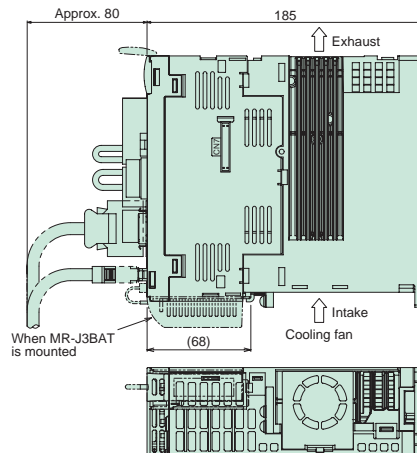
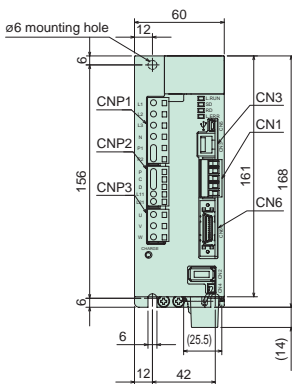

Notes: 1. CNP1, CNP2 and CNP3 connectors (insertion type) and CN1 connector are supplied with the servo amplifier.

MELSERVO-J3

MR-J3-□T□ Servo Amplifier Dimensions

(Unit: mm)

● MR-J3-60T4, 100T4 (Note 1)

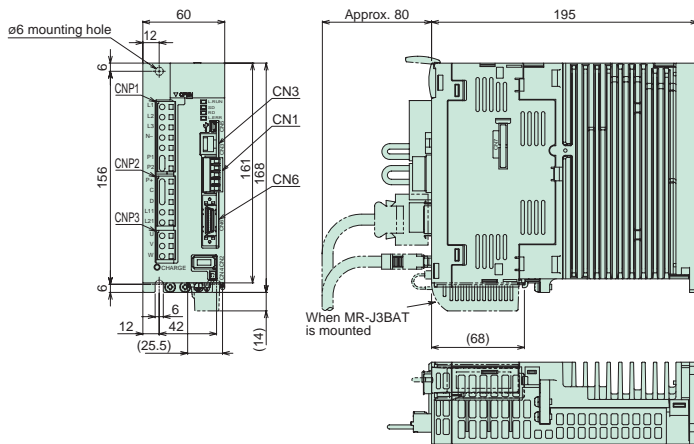

< Terminal arrangement >

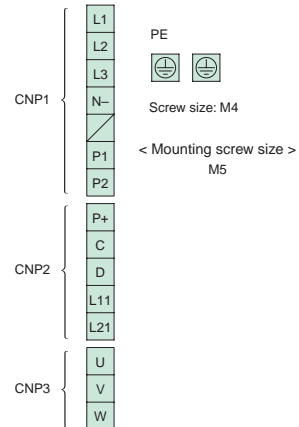

● MR-J3-200TN*², 200T4 (Note 1)

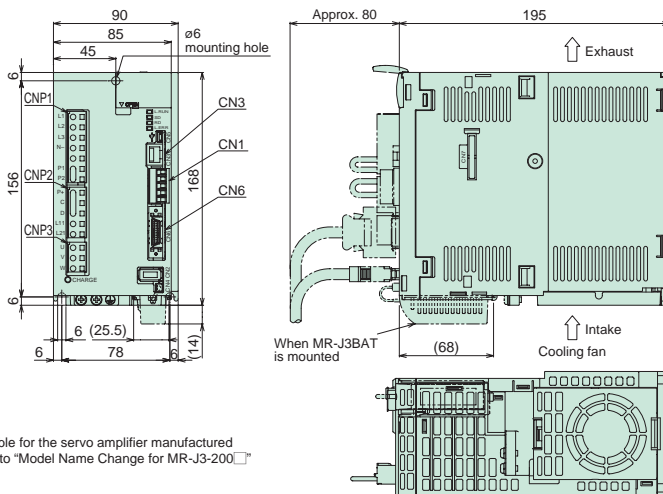

< Terminal arrangement >

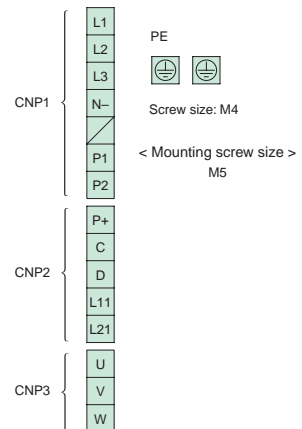

* The dimensions are applicable for the servo amplifier manufactured on July 2010 or later. Refer to "Model Name Change for MR-J3-200□" in this catalog.

● MR-J3-350T (Note 1)

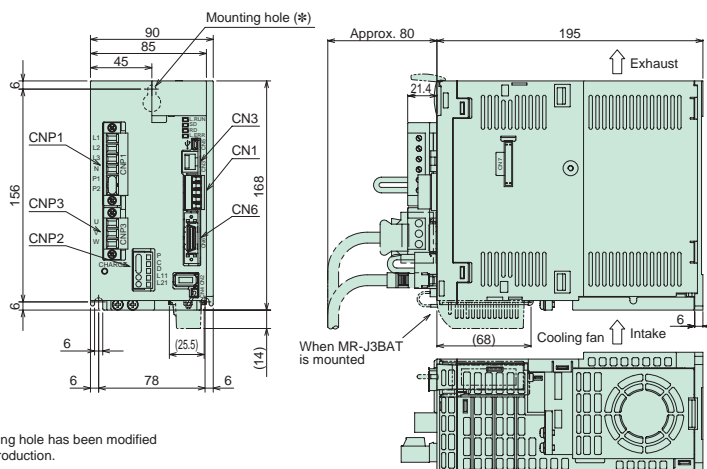

< Terminal arrangement >

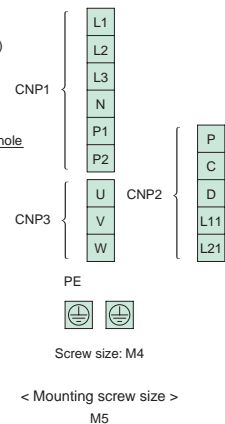

* The shape of the mounting hole has been modified from September 2010 production.

Notes: 1. CNP1, CNP2 and CNP3 connectors (insertion type) and CN1 connector are supplied with the servo amplifier.

(Unit: mm)

● MR-J3-500T, 350T4, 500T4 (Note 1)

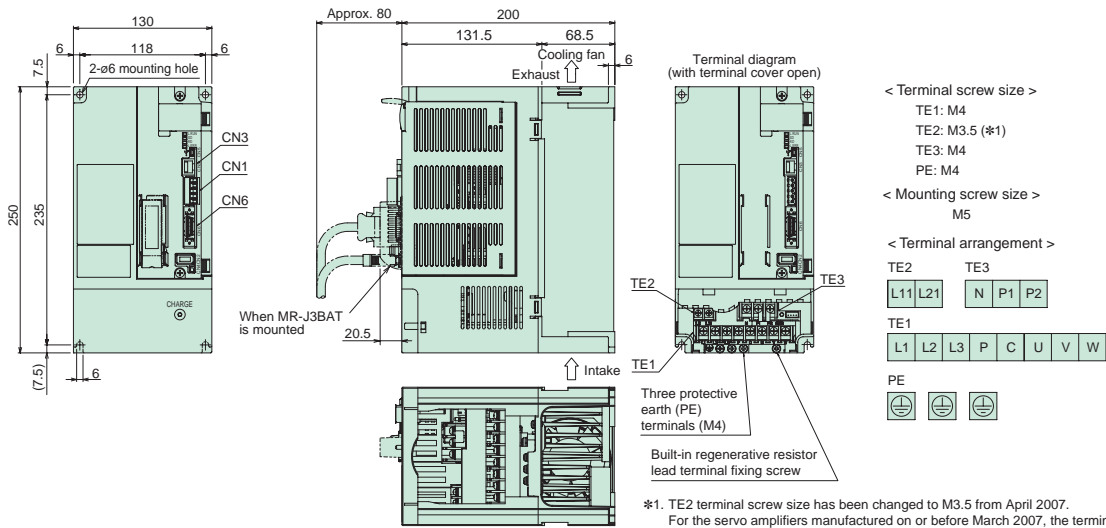

● MR-J3-700T, 700T4 (Note 1)

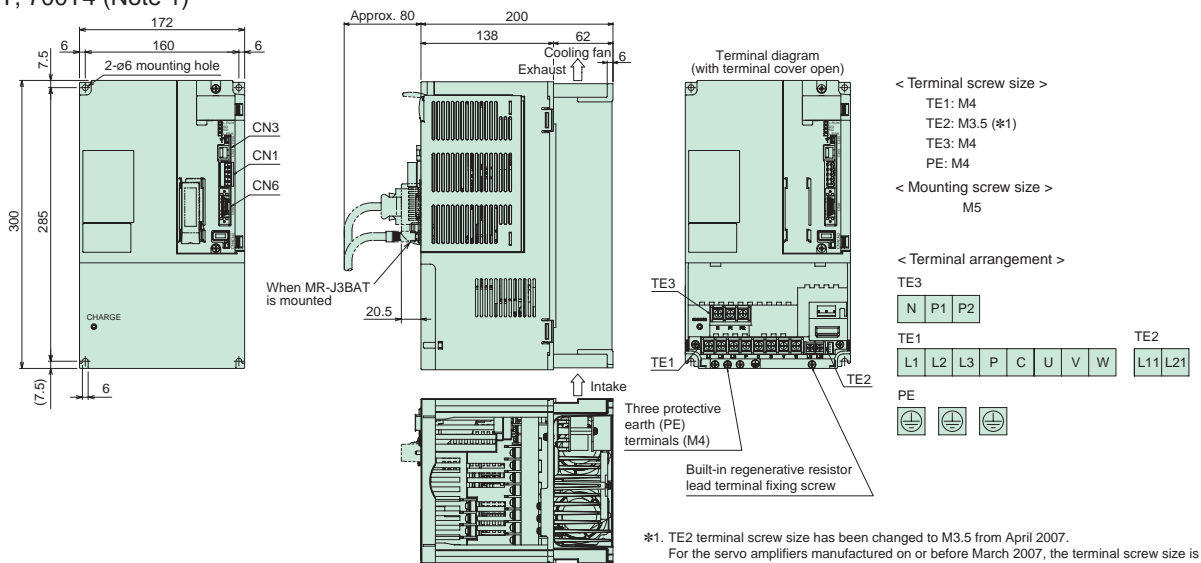

● MR-J3-11KT to 22KT, 11KT4 to 22KT4 (Note 1)

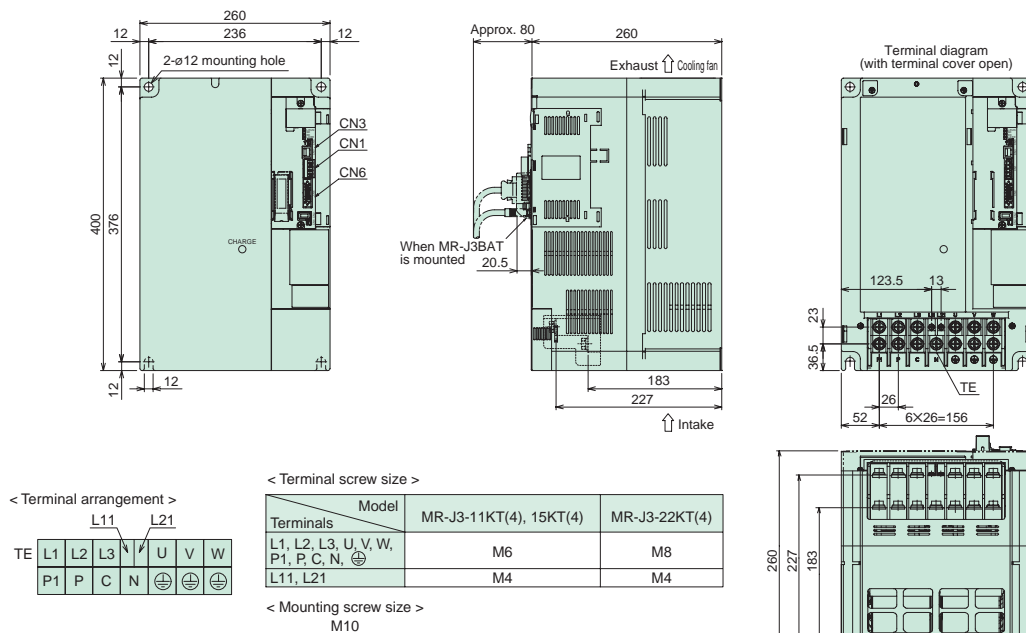

Notes: 1. CN1 connector is supplied with the servo amplifier.

MR-J3 Basic Configurations

Necessary optional cables and connectors vary depending on the servo amplifier type and the servo motor series. Refer to the following tables for necessary options.

● Selecting options for servo amplifier

Servo amplifier/drive unit		Reference	
General-purpose interface	MR-J3-□A/A1/A4, MR-J3-DU□A/A4	P.103 to 104 in this catalog	
SSCNET III compatible	MR-J3-□B/B1/B4, MR-J3-DU□B/B4	P.105 to 106 in this catalog	
Positioning function	MR-J3-□T/T1/T4	CC-Link command	P.107 to 108 in this catalog
		D/I/O command (MR-J3-D01 is required.)	P.107 to 108 in this catalog

● Selecting options for servo motor

Use the cables in the following tables.

For the cable descriptions, refer to the relevant numbers in each list.

Capacity	Servo motor	Reference list		
		Encoder cable	Servo motor power supply cable	Electromagnetic brake cable (Note 1)
Small capacity	HF-KP□(B)	Column A in encoder cable list	Column A in servo motor power supply cable list	Column A in electromagnetic brake cable list
	HF-MP□(B)	Column A in encoder cable list	Column A in servo motor power supply cable list	Column A in electromagnetic brake cable list
Medium capacity	HF-SP□(B)	Column B in encoder cable list	Column B in servo motor power supply cable list	Column B in electromagnetic brake cable list
	HF-JP□(B) 9kW or smaller	Column B in encoder cable list	Column B in servo motor power supply cable list	Column B in electromagnetic brake cable list
	HC-LP□(B)	Column B in encoder cable list	Column C in servo motor power supply cable list	Column C in electromagnetic brake cable list (Note 2)
	HC-RP□(B)	Column B in encoder cable list	Column C in servo motor power supply cable list	— (Note 2)
	HC-UP□(B)	Column B in encoder cable list	Column C in servo motor power supply cable list	Column C in electromagnetic brake cable list (Note 2)
	HA-LP502	Column B in encoder cable list	Column C in servo motor power supply cable list	
Large capacity	HA-LP702	Column B in encoder cable list	Column B in servo motor power supply cable list	
	HF-JP□(B) 11kW or larger	Column C in encoder cable list	Column B in servo motor power supply cable list	Column C in electromagnetic brake cable list
	HA-LP□(B)	Column B in encoder cable list		Column C in electromagnetic brake cable list

Notes: 1. An electromagnetic cable is required only for servo motor with an electromagnetic brake.

2. An electromagnetic cable is not required for HC-RP series and 1.5kW or smaller of HC-LP/HC-UP series as the power supply connector has electromagnetic brake terminals.

● Encoder cable list

	Cable length	IP rating (Note 1)	Cable lead out direction	Bending life	Model	Reference	Note	
A	10m or shorter (Direct connection type)	IP65	Motor shaft side	Long bending life	MR-J3ENCBL□M-A1-H	① on P.111 in this catalog.	Select one from the list.	
				Standard	MR-J3ENCBL□M-A1-L			
			Opposite of motor shaft	Long bending life	MR-J3ENCBL□M-A2-H			② on P.111 in this catalog.
				Standard	MR-J3ENCBL□M-A2-L			
	Exceeding 10m (Relay type)	IP20	Motor shaft side	Long bending life	Two types of cables are required: MR-J3JCBL03M-A1-L and MR-EKCBL□M-H	③ and ⑤ on P.111 in this catalog.		
				Standard	Two types of cables are required: MR-J3JCBL03M-A1-L and MR-EKCBL□M-L			
			Opposite of motor shaft	Long bending life	Two types of cables are required: MR-J3JCBL03M-A2-L and MR-EKCBL□M-H			④ and ⑤ on P.111 in this catalog.
				Standard	Two types of cables are required: MR-J3JCBL03M-A2-L and MR-EKCBL□M-L			
		IP65	Motor shaft side	Long bending life	Two types of cables are required: MR-J3JSCBL03M-A1-L and MR-J3ENCBL□M-H	⑦ and ⑨ on P.111 in this catalog.		
				Standard	Two types of cables are required: MR-J3JSCBL03M-A1-L and MR-J3ENCBL□M-L			
			Opposite of motor shaft	Long bending life	Two types of cables are required: MR-J3JSCBL03M-A2-L and MR-J3ENCBL□M-H			⑧ and ⑨ on P.111 in this catalog.
				Standard	Two types of cables are required: MR-J3JSCBL03M-A2-L and MR-J3ENCBL□M-L			
B	2 to 50m	IP67	—	Long bending life	MR-J3ENCBL□M-H	⑨ on P.111 in this catalog.		
	2 to 30m			Standard	MR-J3ENCBL□M-L			
C	2 to 50m	IP67	—	Long bending life	MR-ENECBL□M-H	⑫ on P.112 in this catalog.	—	

Notes: 1. The IP rating indicated is for the connector's protection against ingress of dust and water when coupled to a servo amplifier/servo motor. If the IP rating of the servo amplifier/servo motor differs from that of these connectors, overall IP rating depends on the lowest of all.

● Servo motor power supply cable list

	Cable length	IP rating (Note 1)	Cable lead out direction	Bending life	Model	Reference	Note
A	10m or shorter (Direct connection type)	IP65	Motor shaft side	Long bending life	MR-PWS1CBL□M-A1-H	⑮ on P.112 in this catalog.	Select one from the list.
				Standard	MR-PWS1CBL□M-A1-L		
			Opposite of motor shaft	Long bending life	MR-PWS1CBL□M-A2-H	⑯ on P.112 in this catalog.	
				Standard	MR-PWS1CBL□M-A2-L		
Exceeding 10m (Relay type)	IP55	Motor shaft side	Standard	Connect a user-manufactured cable to MR-PWS2CBL03M-A1-L (optional cable).		⑰ on P.112 in this catalog.	
		Opposite of motor shaft		Connect a user-manufactured cable to MR-PWS2CBL03M-A2-L (optional cable).		⑱ on P.112 in this catalog.	

	IP rating (Note 1)	Servo motor	Model	Reference	Note
B	IP67	HF-SP51, 81 HF-SP52(4), 102(4), 152(4) HF-JP53(4), 73(4), 103(4), 153(4), 203(4), 3534, 5034	Manufacture a cable that fits to MR-PWCNS4 (optional connector set).	⑲ on P.112 in this catalog.	Select one that is compatible with the servo motor.
		HF-SP121, 201, 301 HF-SP202(4), 352(4), 502(4) HF-JP353, 503	Manufacture a cable that fits to MR-PWCNS5 (optional connector set).	⑳ on P.112 in this catalog.	
		HF-SP421, 702(4) HF-JP703(4), 903(4), 11K1M(4), 15K1M(4) HA-LP702	Manufacture a cable that fits to MR-PWCNS3 (optional connector set).	㉑ on P.113 in this catalog.	
C	IP67	HC-LP52, 102, 152 HC-RP103, 153, 203 HC-UP72, 152	Manufacture a cable that fits to MR-PWCNS1 (optional connector set).	㉒ on P.113 in this catalog.	Select one that is compatible with the servo motor.
		HC-LP202, 302 HC-RP353, 503 HC-UP202, 352, 502 HA-LP502	Manufacture a cable that fits to MR-PWCNS2 (optional connector set).	㉓ on P.113 in this catalog.	

● Electromagnetic brake cable list

	Cable length	IP rating (Note 1)	Cable lead out direction	Bending life	Model	Reference	Note
A	10m or shorter (Direct connection type)	IP65	Motor shaft side	Long bending life	MR-BKS1CBL□M-A1-H	㉔ on P.113 in this catalog.	Select one from the list.
				Standard	MR-BKS1CBL□M-A1-L		
			Opposite of motor shaft	Long bending life	MR-BKS1CBL□M-A2-H	㉕ on P.113 in this catalog.	
				Standard	MR-BKS1CBL□M-A2-L		
Exceeding 10m (Relay type)	IP55	Motor shaft side	Standard	Connect a user-manufactured cable to MR-BKS2CBL03M-A1-L (optional cable).		㉖ on P.113 in this catalog.	
		Opposite of motor shaft		Connect a user-manufactured cable to MR-BKS2CBL03M-A2-L (optional cable).		㉗ on P.113 in this catalog.	

	IP rating (Note 1)	Servo motor	Model	Reference	Note
B	IP67	HF-SP series HF-JP53(4)B, 73(4)B, 103(4)B, 153(4)B, 203(4)B, 353(4)B, 503(4)B, 703(4)B, 903(4)B	Manufacture a cable that fits to MR-BKCNS1 (optional connector set) (straight type).	㉘ on P.113 in this catalog.	Select one that is compatible with the servo motor.
			Manufacture a cable that fits to MR-BKCNS1A (optional connector set) (angled type).	㉙ on P.113 in this catalog.	
C	IP67	HF-JP11K1M(4)B, 15K1M(4)B HC-LP202B, 302B HC-UP202B, 352B, 502B HA-LP601(4)B, 801(4)B, 12K1(4)B, 701M(4)B, 11K1M(4)B, 15K1M(4)B, 11K2(4)B, 15K2(4)B, 22K2(4)B	Manufacture a cable that fits to MR-BKCN (optional connector set).	㉚ on P.113 in this catalog.	

Notes: 1. The IP rating indicated is for the connector's protection against ingress of dust and water when coupled to a servo amplifier/servo motor. If the IP rating of the servo amplifier/servo motor differs from that of these connectors, overall IP rating depends on the lowest of all.

MELSERVO-J3

Options

● Cables and connectors for MR-J3-A

For servo amplifier MR-J3-□A/A1/A4 3.5kW or smaller (200V) and 2kW or smaller (400V)

- QD70P
- QD70D
- QD75P
- QD75D
- LD75P
- LD75D
- A1SD75P
- FX2N-20GM
- FX2N-10GM
- FX2N-10PG
- FX2N-1PG

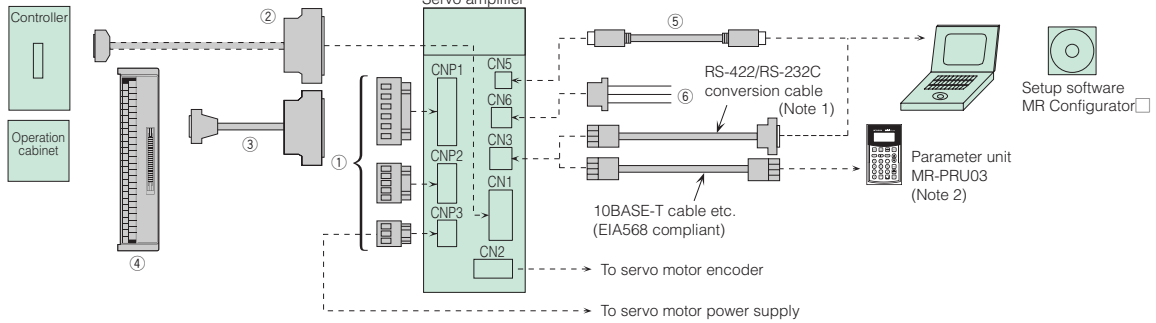

For servo amplifier MR-J3-□A/A4 5kW to 22kW (200V) and 3.5kW to 22kW (400V)

- QD70P
- QD70D
- QD75P
- QD75D
- LD75P
- LD75D
- A1SD75P
- FX2N-20GM
- FX2N-10GM
- FX2N-10PG
- FX2N-1PG

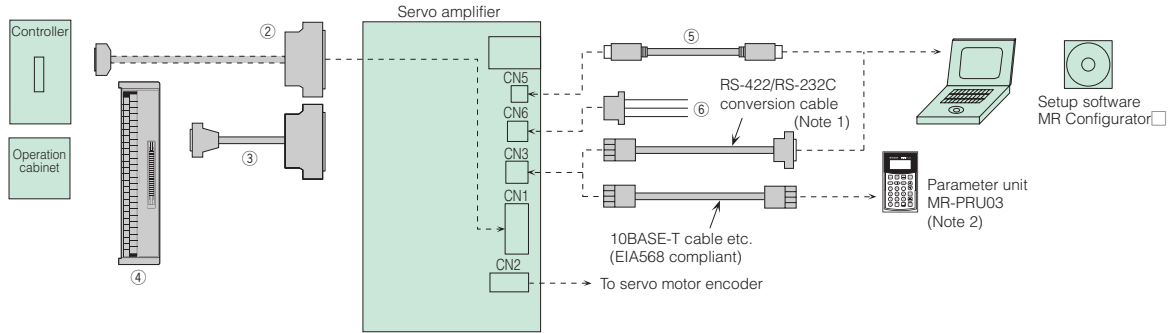





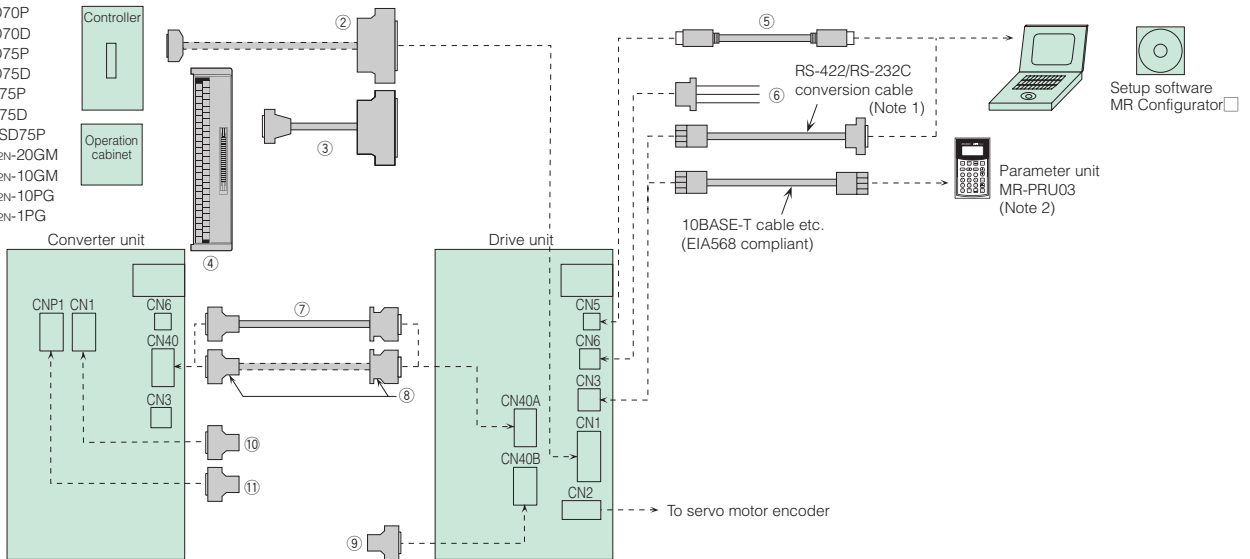



















For drive unit MR-J3-DU□A/A4

- QD70P
- QD70D
- QD75P
- QD75D
- LD75P
- LD75D
- A1SD75P
- FX2N-20GM
- FX2N-10GM
- FX2N-10PG
- FX2N-1PG



Notes: 1. Refer to "Ordering Information for Customers" in this catalog.
2. Refer to "Option ● Parameter unit" in this catalog.

● Cables and connectors for MR-J3-A

Item			Model	IP rating	Description			
For CNP1, CNP2, and CNP3	①	For MR-J3-100A/B (-RJ006)/T or smaller MR-J3-40A1/B1 (-RJ006)/T1 or smaller	(Standard accessory: Insertion type)	—	CNP1 connector  54928-0670 (connector) (Molex or an equivalent product)	CNP2 connector  54927-0520 (connector) (Molex or an equivalent product)	CNP3 connector  54928-0370 (connector) (Molex or an equivalent product)	Insertion tool  54932-0000 (Molex or an equivalent product)
		For MR-J3-350A MR-J3-350B MR-J3-350B-RJ006 MR-J3-350T			CNP1 connector  PC 4/ 6-STF-7.62-CRW (connector) (PHOENIX or an equivalent product)	CNP2 connector  54927-0520 (connector) (Molex or an equivalent product)	CNP3 connector  PC 4/ 3-STF-7.62-CRW (connector) (PHOENIX or an equivalent product)	Insertion tool  54932-0000 (Molex or an equivalent product)
		For MR-J3-200AN (Note 5) MR-J3-200BN (Note 5) MR-J3-200BN-RJ006 (Note 5) MR-J3-200TN (Note 5) MR-J3-200A4 or smaller MR-J3-200B4 or smaller MR-J3-200B4-RJ006 or smaller MR-J3-200T4 or smaller			CNP1 connector  721-207/026-000 (plug) (WAGO or an equivalent product)	CNP2 connector  721-205/026-000 (plug) (WAGO or an equivalent product)	CNP3 connector  721-203/026-000 (plug) (WAGO or an equivalent product)	Insertion tool  231-131 (WAGO or an equivalent product)
For CN1	②	Connector set (for CN1)	MR-J3CN1	—	 Amplifier connector (3M or an equivalent product) 10150-3000PE (connector) 10350-52F0-008 (shell kit)			
		③	Junction terminal block cable	MR-J2M-CN1TBL□M □=cable length: 0.5, 1m	—	Junction terminal block connector (3M) D7950-B500FL (connector)  Amplifier connector (3M or an equivalent product) 10150-6000EL (connector) 10350-3210-000 (shell kit) (Note 1)		
			④	Junction terminal block	MR-TB50	—		
For CN5	⑤	Personal computer communication cable	USB cable	MR-J3USBCBL3M Cable length: 3m	—	Amplifier connector mini-B connector (5 pins)  Personal computer connector A connector 		
For CN6	⑥	Monitor cable		MR-J3CN6CBL1M Cable length: 1m	—	 Amplifier connector (Molex) 51004-0300 (housing) 50011-8100 (terminal)		
For drive unit CN40A and converter unit CN40	⑦	Protection coordination cable		MR-J3CDL05M Cable length: 0.5m	—	Converter unit connector (3M or an equivalent product) 10120-3000PE (connector) 10320-52F0-008 (shell kit) (Note 2)  Drive unit connector (HONDA TSUSHIN KOGYO) PCR-S20FS+ (connector) PCR-LS20LA1 (case) 		
		⑧	Connector set		MR-J2CN1-A	—	Converter unit connector (3M or an equivalent product) 10120-3000PE (connector) 10320-52F0-008 (shell kit) (Note 2)  Drive unit connector (HONDA TSUSHIN KOGYO) PCR-S20FS+ (connector) PCR-LS20LA1 (case) 	
For drive unit CN40B	⑨	Terminal connector		MR-J3-TM	—	 Terminal connector		
For converter unit	⑩	Control signal connector (for CN1)	(Standard accessory)		—	 Converter unit connector (DDK) 17JE23090-02(D8A)K11-CG (connector)		
		Magnetic contactor control connector (for CNP1)	(Standard accessory)		—	 Converter unit connector (PHOENIX) GFKC 2,5/ 2-STF-7,62 (socket)		

- Notes: 1. The connector and the shell kit are of press bonding type. Models for solder type are 10150-3000PE (connector) and 10350-52F0-008 (shell kit).
 2. The connector and the shell kit are of solder type. Models for press bonding type are 10120-6000EL (connector) and 10320-3210-000 (shell kit).
 3. Refer to "Peripheral Equipment ● Electrical wires, circuit breakers, magnetic contactors (example of selection)" in this catalog for details on examples of wire size selection.
 4. This connector set is not required for 200V 5kW or larger and 400V 3.5kW or larger servo amplifiers since terminal blocks are mounted. Refer to "Servo Amplifier Dimensions" in this catalog for more details.
 5. Contact your local sales office for the connectors of MR-J3-200□ servo amplifier manufactured on or before March 2008 and MR-J3-200B-RJ006.

Model designation
Servo motors
Servo amplifiers
Options
Peripheral equipment
MR-J3-B Safety
MR-J3W series
Servo support software
Cautions
Warranty
Global FA centers

MELSERVO-J3

Options

● Cables and connectors for MR-J3-B

For servo amplifier MR-J3-□B/B1/B4 3.5kW or smaller (200V) and 2kW or smaller (400V)

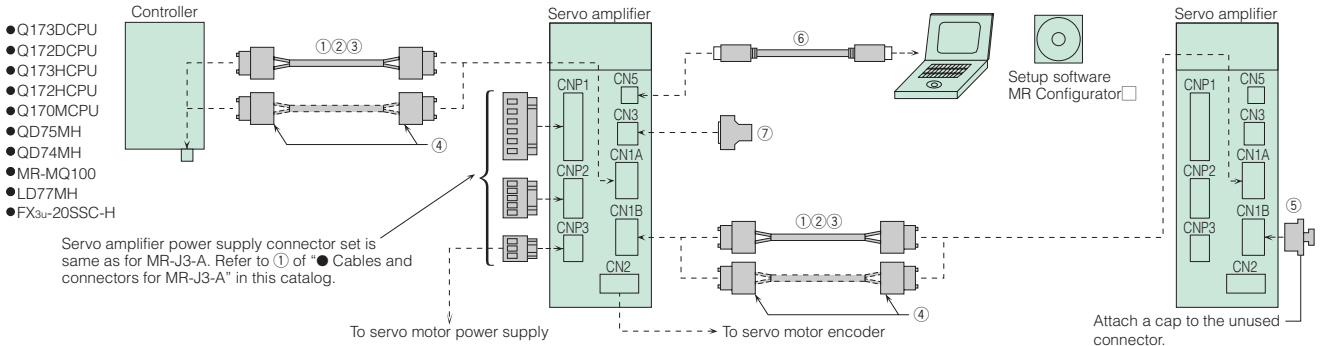

For servo amplifier MR-J3-□B/B4 5kW to 22kW (200V) and 3.5kW to 22kW (400V)

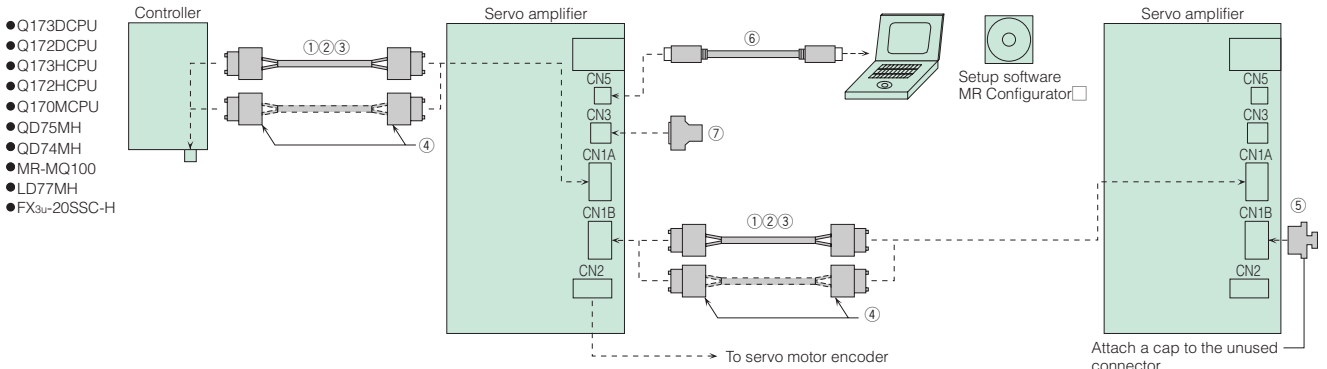

For drive unit MR-J3-DU□B/B4

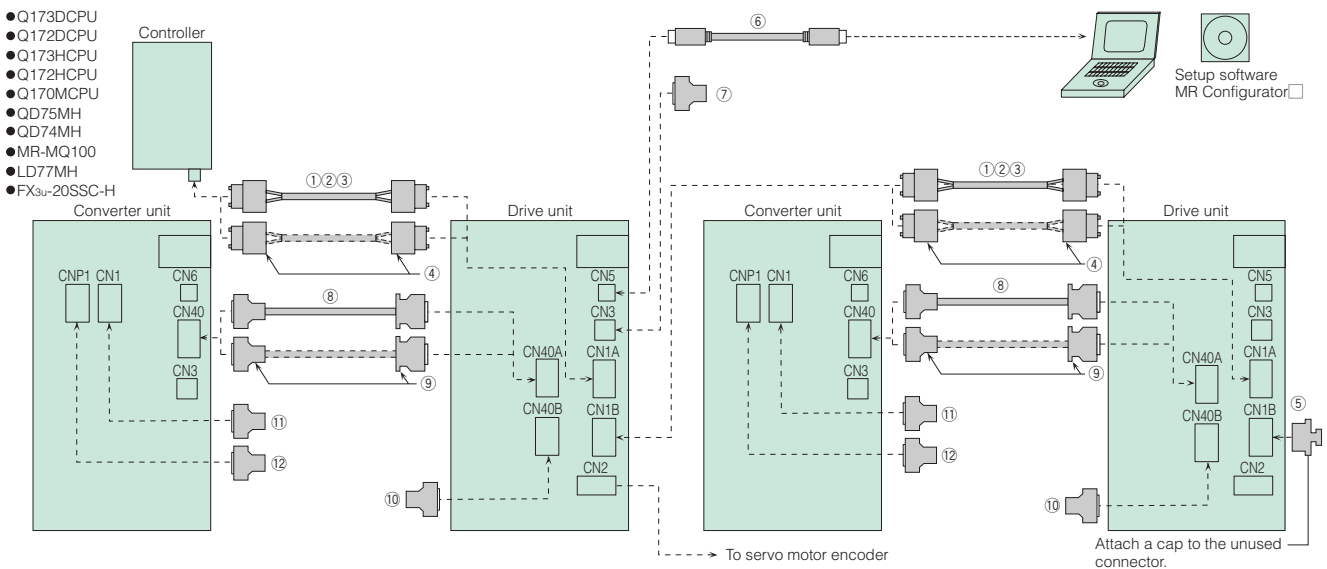

For Servo amplifier MR-J3-□B/B1/B4-RJ006

Options other than for CN2L connector are same as those for MR-J3-B. Refer to the above illustrations.

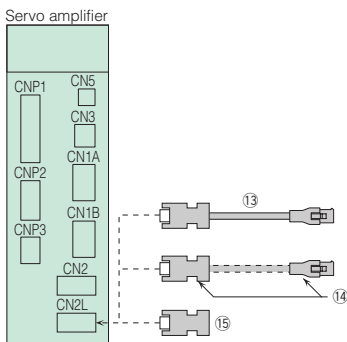

Necessary options for CN2L connector vary depending on a linear encoder.
Refer to "MR-J3-□B-RJ006 SERVO AMPLIFIER INSTRUCTION MANUAL" for details.

● Cables and connectors for MR-J3-B

Servo amplifier power supply connector set is same as for MR-J3-A. Refer to ① of “● Cables and connectors for MR-J3-A” in this catalog.

Item		Model	IP rating (Note 5)	Description
For controller, CN1A and CN1B	①	SSCNET III cable (Note 4) (Standard cord for inside cabinet)	—	Connector (Japan Aviation Electronics Industry) PF-2D103 (connector) Connector (Japan Aviation Electronics Industry) PF-2D103 (connector)
	②	SSCNET III cable (Note 4) (Standard cable for outside cabinet)	—	
	③	SSCNET III cable (Note 4) (Long distance cable, long bending life)	—	Connector (Japan Aviation Electronics Industry) CF-2D103-S (connector) Connector (Japan Aviation Electronics Industry) CF-2D103-S (connector)
	④	Connector set for SSCNET III (Note 4)	MR-J3BCN1 (Note 3)	—
For CN1B	⑤	Connector cap for SSCNET III	(Standard accessory)	—
For CN5	⑥	Personal computer communication cable USB cable	MR-J3USBCBL3M Cable length: 3m	—
For CN3	⑦	Input/output signal connector set	MR-CCN1	—
For drive unit CN40A and converter unit CN40	⑧	Protection coordination cable	MR-J3CDL05M Cable length: 0.5m	—
	⑨	Connector set	MR-J2CN1-A	—
For drive unit CN40B	⑩	Terminal connector	MR-J3-TM	—
For converter unit	⑪	Control signal connector (for CN1)	(Standard accessory)	—
	⑫	Magnetic contactor control connector (for CNP1)	(Standard accessory)	—
For CN2L	⑬	Encoder cable (for CN2L)	MR-EKCBL□M-H □=cable length: 2, 5, 10m (Note 6)	IP20
	⑭	Junction connector set (for CN2L)	MR-ECNM	IP20
	⑮	Connector set (for CN2L)	MR-J3CN2	—

- Notes: 1. The connector and the shell kit are of solder type. Models for press bonding type are 10120-6000EL (connector) and 10320-3210-000 (shell kit).
2. For the ultra-long bending life cables and/or for unlisted lengths which are 20m or shorter (available in the ultra-long bending life cables), contact Mitsubishi Electric System & Service Co., Ltd. FA PRODUCT DIVISION by email: oss-ip@melsc.jp
3. Special tools are required. Contact your local sales office for details.
4. Look carefully through the precautions enclosed with the options before use.
5. The IP rating indicated is for the connector's protection against ingress of dust and water when coupled to a servo amplifier/servo motor. If the IP rating of the servo amplifier/servo motor differs from that of these connectors, overall IP rating depends on the lowest of all.
6. -H indicates a long bending life.

Model designation
Servo motors
Servo amplifiers
Options
Peripheral equipment
MR-J3-B Safety
MR-J3W series
Servo support software
Cautions
Warranty
Global FA centers

MELSERVO-J3

Options

● Cables and connectors for MR-J3-T

For servo amplifier MR-J3-□T/T1/T4 3.5kW or smaller (200V) and 2kW or smaller (400V)

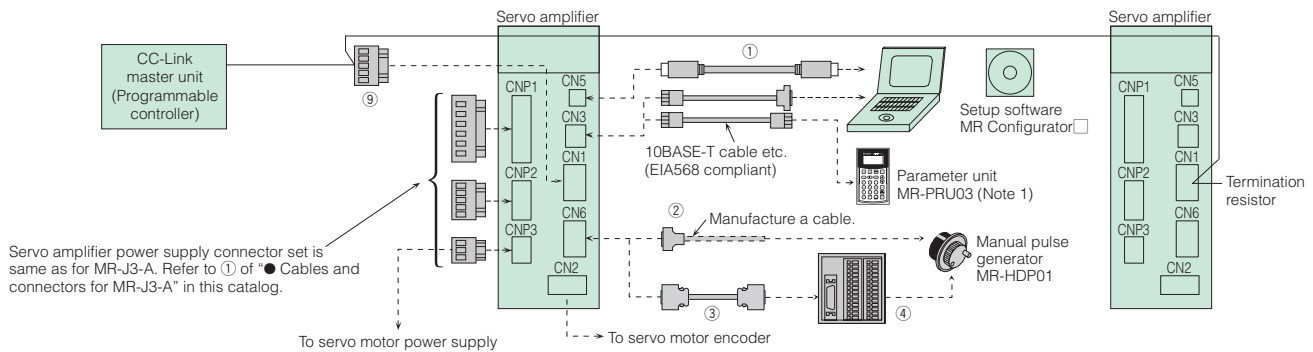

For servo amplifier MR-J3-□T/T4 5kW to 22kW (200V) and 3.5kW to 22kW (400V)

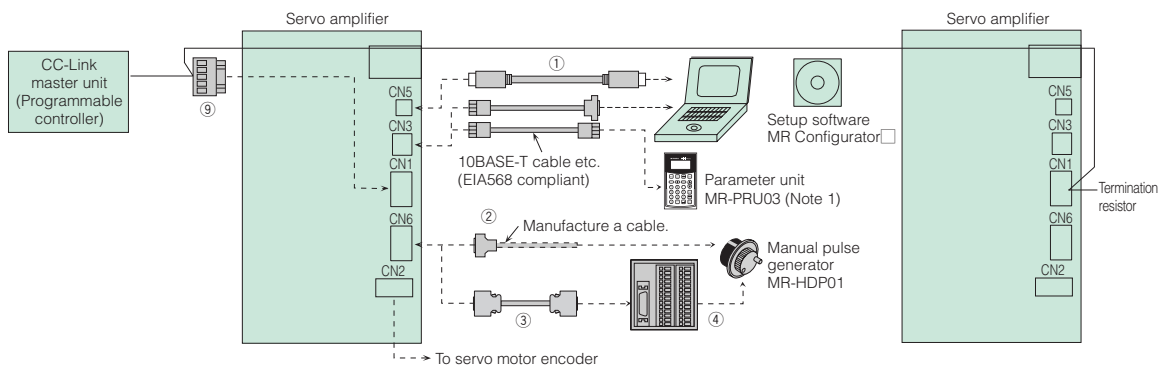

Using MR-J3-D01 extension IO unit



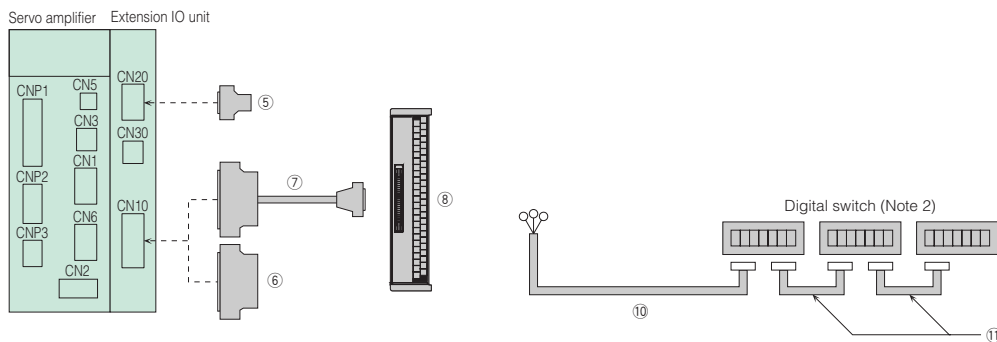







Options for the servo amplifier are same as when the MR-J3-D01 is not used. Refer to the above illustrations.

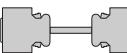

Notes: 1. Refer to "Options ● Parameter unit for details."
2. Refer to "Options ● 6-digit digital switch for details."

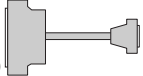
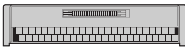
● Cables and connectors for MR-J3-T

Servo amplifier power supply connector set is same as for MR-J3-A. Refer to ① of “● Cables and connectors for MR-J3-A” in this catalog.

Item		Model	IP rating	Description
For CN5	① Personal computer communication cable	MR-J3USBCBL3M Cable length: 3m	—	Amplifier connector mini-B connector (5 pins) Personal computer connector A connector 
	USB cable			
For CN6	② Connector set (for CN6)	MR-J2CMP2	—	 Amplifier connector (3M or an equivalent product) 10126-3000PE (connector) 10326-52F0-008 (shell kit)
	③ Junction terminal block cable	MR-TBNATBL□M □=cable length: 0.5, 1m	—	Junction terminal block connector (3M or an equivalent product) 10126-6000EL (connector) 10326-3210-000 (shell kit)  Amplifier connector (3M or an equivalent product) 10126-6000EL (connector) 10326-3210-000 (shell kit)
	④ Junction terminal block	MR-TB26A	—	
For CN20	⑤ Input/output signal connector set	MR-CCN1	—	 Amplifier connector (3M or an equivalent product) 10120-3000PE (connector) 10320-52F0-008 (shell kit) (Note 1)
For CN10	⑥ Input/output signal connector set	MR-J3CN1	—	 Amplifier connector (3M or an equivalent product) 10150-3000PE (connector) 10350-52F0-008 (shell kit)
	⑦ Junction terminal block cable	MR-J2M-CN1TBL□M □=cable length: 0.5, 1m	—	Amplifier connector (3M or an equivalent product) 10150-6000EL (connector) 10350-3210-000 (shell kit) (Note 2)  Junction terminal block connector (3M) D7950-B500FL (connector)
	⑧ Junction terminal block	MR-TB50	—	
For CN1	⑨ CC-Link connector	(Standard accessory)	—	 CC-Link connector (PHOENIX) MSTBT 2,5/ 5-ST-5,08
	⑩ Digital switch cable (for between MR-DS60 and MR-J3-D01)	MR-DSCBL□M-G □=cable length: 3, 5, 10m	—	
	⑪ Digital switch cable (for between each MR-DS60)	MR-DSCBL□ □=cable length: 25, 100cm	—	

Notes: 1. The connector and the shell kit are of solder type. Models for press bonding type are 10120-6000EL (connector) and 10320-3210-000 (shell kit).
2. The connector and the shell kit are of press bonding type. Models for solder type are 10150-3000PE (connector) and 10350-52F0-008 (shell kit).

Model designation
Servo motors
Servo amplifiers
Options
Peripheral equipment
MR-J3-BSafety
MR-J3W series
Servo support software
Cautions
Warranty
Global FA centers

Options

● Cables and connectors for servo motor

For HF-KP/HF-MP servo motor series: encoder cable length 10m or shorter

- For leading the cables out in a direction of the motor shaft (Note 4)

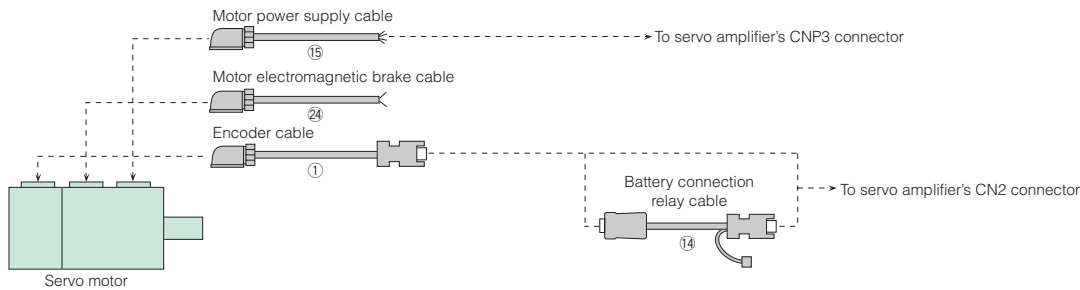

- For leading the cables out in an opposite direction of the motor shaft (Note 4)

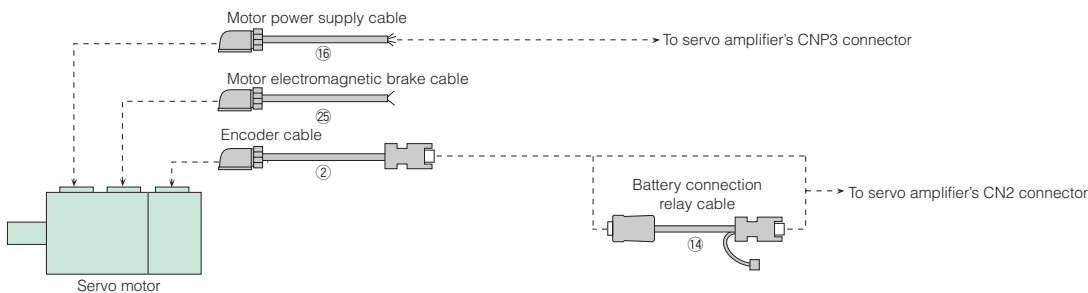

For HF-KP/HF-MP servo motor series: encoder cable length over 10m

- For leading the cables out in a direction of the motor shaft (Note 4)

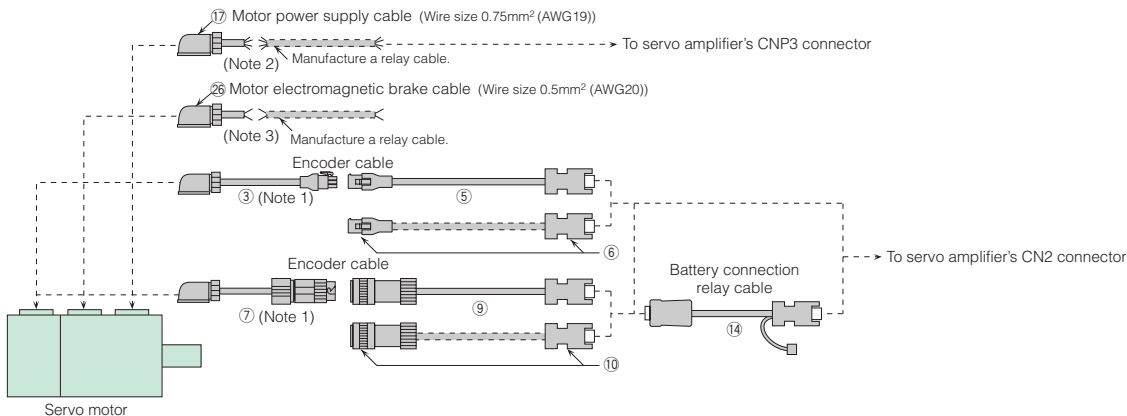

- For leading the cables out in an opposite direction of the motor shaft (Note 4)

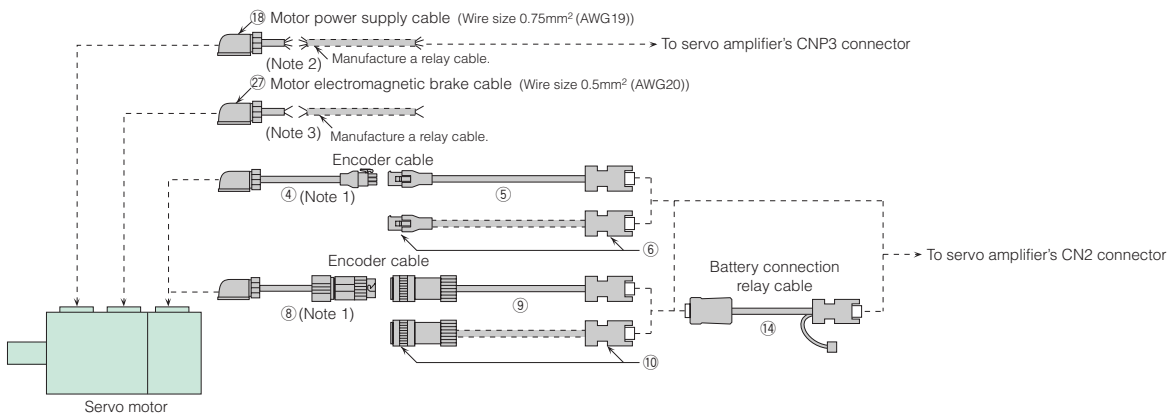

- Notes:
1. This cable does not have a long bending life, so always fix the cable before using.
 2. If the length exceeds 10m, relay a cable using MR-PWS2CBL03M-A1-L/A2-L cable. This cable does not have a long bending life, so always fix the cable before using. Refer to "MR-J3 SERVO AMPLIFIER INSTRUCTION MANUAL" for details on manufacturing the relay cable.
 3. If the length exceeds 10m, relay a cable using MR-BKS2CBL03M-A1-L/A2-L cable. This cable does not have a long bending life, so always fix the cable before using. Refer to "MR-J3 SERVO AMPLIFIER INSTRUCTION MANUAL" for details on manufacturing the relay cable.
 4. Cables for leading two different directions may be used for one servo motor.

For HF-SP servo motor series

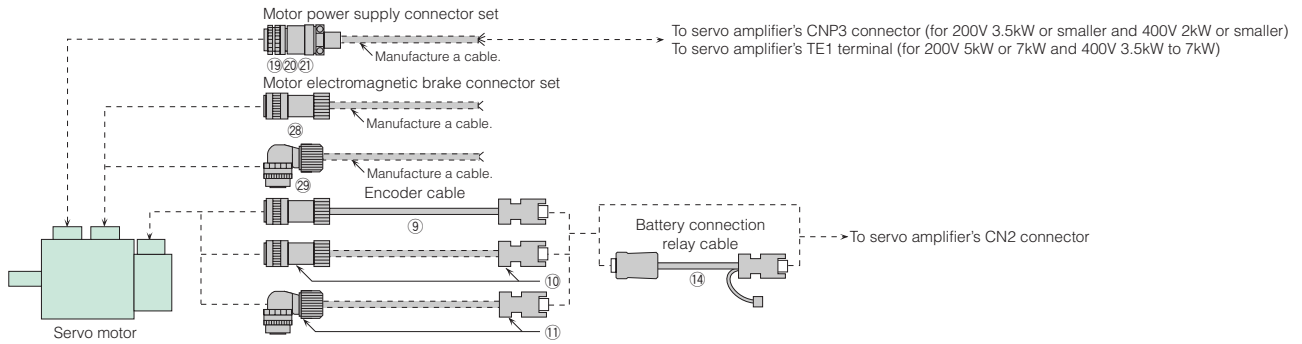

For HF-JP servo motor series 9kW or smaller

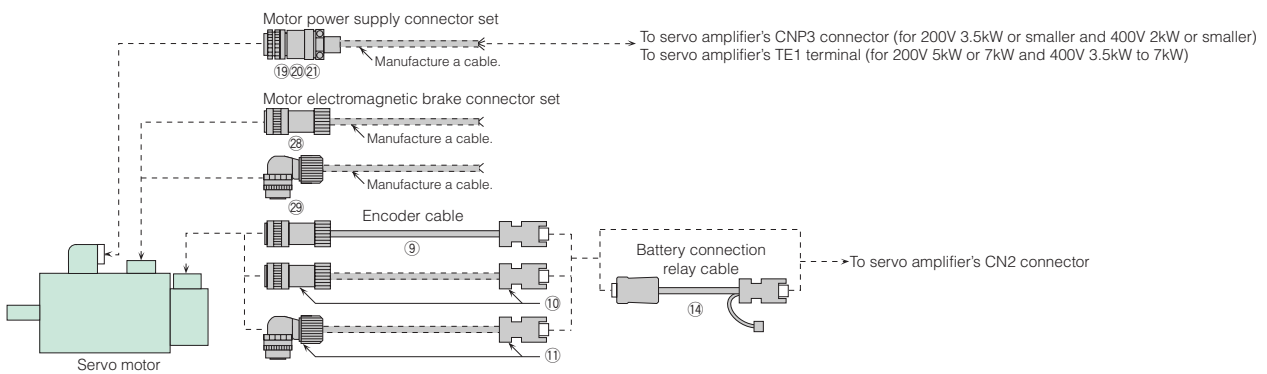

For HF-JP servo motor series 11kW and 15kW

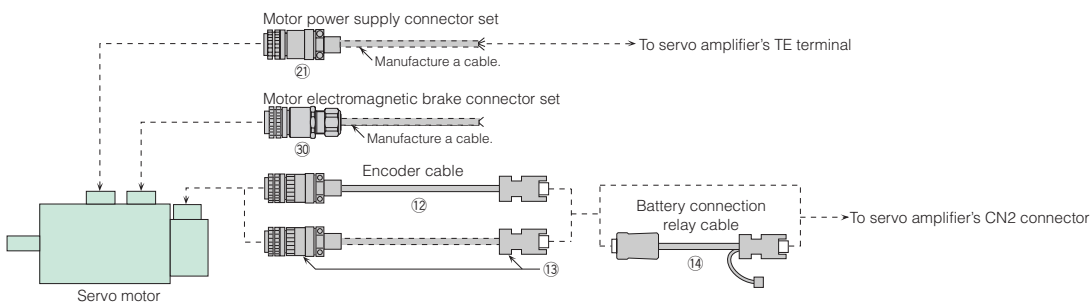

For HC-LP/HC-RP/HC-UP servo motor series or HA-LP502/702

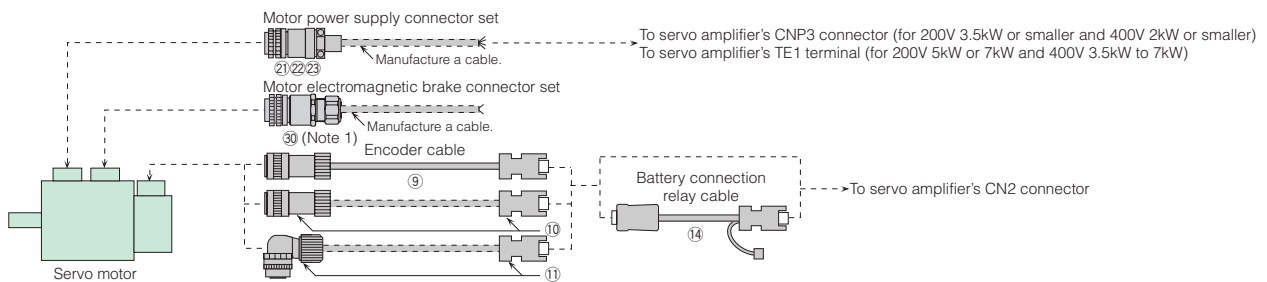

Notes: 1. An electromagnetic brake connector set is not required for HC-RP series and 1.5kW or smaller of HC-LP/HC-UP series as the power supply connector has electromagnetic brake terminals.

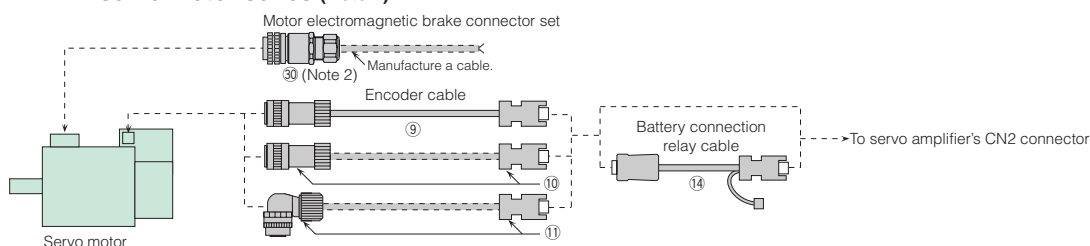

For HA-LP servo motor series (Note 1)



Notes: 1. HA-LP502 and 702 are excluded.
2. Servo motors with an electromagnetic brake are available in 12kW or smaller for HA-LP 1000r/min series, 15kW or smaller for HA-LP 1500r/min series and 11kW to 22kW for HA-LP 2000r/min series.



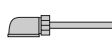
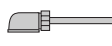

Options

● Cables and connectors for servo motor

Item		Model	IP rating (Note 2)	Description
For encoder	① 10m or shorter (Direct connection type)	Encoder cable for HF-KP/HF-MP series Lead out in direction of motor shaft MR-J3ENCBL□M-A1-H □=cable length: 2, 5, 10m (Note 1, 3)	IP65	Encoder connector (Tyco Electronics) 1674320-1 
		MR-J3ENCBL□M-A1-L □=cable length: 2, 5, 10m (Note 1)	IP65	
	②	Encoder cable for HF-KP/HF-MP series Lead out in opposite direction of motor shaft MR-J3ENCBL□M-A2-H □=cable length: 2, 5, 10m (Note 1, 3)	IP65	Amplifier connector 36210-0100PL (receptacle, 3M) 36310-3200-008 (shell kit, 3M), or 54599-1019 (connector set, Molex)
		MR-J3ENCBL□M-A2-L □=cable length: 2, 5, 10m (Note 1)	IP65	
	③	Motor-side encoder cable for HF-KP/HF-MP series Lead out in direction of motor shaft MR-J3JCBL03M-A1-L Cable length: 0.3m (Note 1)	IP20	Encoder connector (Tyco Electronics) 1674320-1 
	④	Motor-side encoder cable for HF-KP/HF-MP series Lead out in opposite direction of motor shaft MR-J3JCBL03M-A2-L Cable length: 0.3m (Note 1)	IP20	Junction connector (Tyco Electronics) 1473226-1 (with ring) (contact) 1-172169-9 (housing) 316454-1 (cable clamp)
	⑤	Amplifier-side encoder cable for HF-KP/HF-MP series MR-EKCBL□M-H □=cable length: 20, 30, 40, 50m (Note 1, 3, 6)	IP20	Junction connector (Tyco Electronics) 1-172161-9 (housing) 170359-1 (connector pin) MTI-0002 (cable clamp, TOA ELECTRIC INDUSTRIAL)
			MR-EKCBL□M-L □=cable length: 20, 30m (Note 1, 6)	IP20
	⑥	Exceeding 10m (Relay type) Junction connector set for HF-KP/HF-MP series MR-ECNM	IP20	Junction connector (Tyco Electronics) 1-172161-9 (housing) 170359-1 (connector pin) MTI-0002 (cable clamp, TOA ELECTRIC INDUSTRIAL)
			IP20	Amplifier connector 36210-0100PL (receptacle, 3M) 36310-3200-008 (shell kit, 3M), or 54599-1019 (connector set, Molex)
	⑦	Motor-side encoder cable for HF-KP/HF-MP series Lead out in direction of motor shaft MR-J3JSCBL03M-A1-L Cable length: 0.3m (Note 1)	IP65 (Note 5)	Encoder connector (Tyco Electronics) 1674320-1 
⑧	Motor-side encoder cable for HF-KP/HF-MP series Lead out in opposite direction of motor shaft MR-J3JSCBL03M-A2-L Cable length: 0.3m (Note 1)	IP65 (Note 5)	Junction connector (DDK) CM10-CR10P-M (cable receptacle)	
⑨	Encoder cable for HF-KP/HF-MP/HF-SP/HC-LP/ HC-RP/HC-UP/HA-LP series HF-JP53, 73, 103, 153, 203, 353, 503, 703, 903, 534, 734, 1034, 1534, 2034, 3534, 5034, 7034, 9034	MR-J3ENSCBL□M-H □=cable length: 2, 5, 10, 20, 30, 40, 50m (Note 1, 3, 4)	IP67	Amplifier connector 36210-0100PL (receptacle, 3M) 36310-3200-008 (shell kit, 3M), or 54599-1019 (connector set, Molex)
		MR-J3ENSCBL□M-L □=cable length: 2, 5, 10, 20, 30m (Note 1, 4)	IP67	Encoder connector (DDK) <For 10m or shorter cable> CM10-SP10S-M (D6) (straight plug) CM10-#22SC(C1) (D8)-100 (socket contact)
⑩	Encoder connector set for HF-KP/HF-MP/HF-SP/HC-LP/ HC-RP/HC-UP/HA-LP series HF-JP53, 73, 103, 153, 203, 353, 503, 703, 903, 534, 734, 1034, 1534, 2034, 3534, 5034, 7034, 9034	MR-J3SCNS (Note 4)	IP67	Amplifier connector 36210-0100PL (receptacle, 3M) 36310-3200-008 (shell kit, 3M), or 54599-1019 (connector set, Molex)
⑪	Encoder connector set for HF-SP/HC-LP/HC-RP/HC-UP/ HA-LP series HF-JP53, 73, 103, 153, 203, 353, 503, 703, 903, 534, 734, 1034, 1534, 2034, 3534, 5034, 7034, 9034	MR-J3SCNSA (Note 4)	IP67	Encoder connector (DDK) CM10-SP10S-M (D6) (straight plug) CM10-#22SC(S1) (D8)-100 (socket contact)
		MR-J3SCNSA (Note 4)	IP67	Amplifier connector 36210-0100PL (receptacle, 3M) 36310-3200-008 (shell kit, 3M), or 54599-1019 (connector set, Molex)

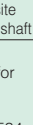
- Notes: 1. -H and -L indicate a bending life. -H indicates a long bending life, and -L indicates a standard bending life.
 2. The IP rating indicated is for the connector's protection against ingress of dust and water when coupled to a servo amplifier/servo motor. If the IP rating of the servo amplifier/servo motor differs from that of these connectors, overall IP rating depends on the lowest of all.
 3. For the ultra-long bending life cables and/or for unlisted lengths (available in the ultra-long bending life cables), contact Mitsubishi Electric System & Service Co., Ltd. FA PRODUCT DIVISION by email: oss-ip@melsc.jp
 4. Select from below if there is a potential risk that a high vibration may be applied to connectors.
 Encoder cable: MR-J3ENCBL□M-H-S06 (long bending life) or MR-J3ENCBL□M-L-S06 (standard bending life)
 Encoder connector set: MR-J3SCNS-S06 (straight type) or MR-J3SCNSA-S06 (angled type)
 Connector cover: MR-J3ENS-CVR (straight type) or MR-J3ENSA-CVR (angled type)
 Be sure to use this connector cover when using the encoder cable or the encoder connector set in the table.
 Contact your local sales office for more details.
 5. The encoder cable is rated IP65 while the junction connector is rated IP67.
 6.  are available in 4-wire type. Parameter setting is required to use the 4-wire type encoder cable. Refer to "MR-J3 SERVO AMPLIFIER INSTRUCTION MANUAL" for more details.

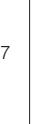
● Cables and connectors for servo motor









Item		Model	IP rating (Note 2)	Description
For encoder	⑫	Encoder cable for HF-JP11K1M, 15K1M, 11K1M4, 15K1M4 MR-ENECBL□M-H □=cable length: 2, 5, 10, 20, 30, 40, 50m (Note 1, 4, 5)	IP67	Encoder connector (DDK) D/MS3106A20-29S(D190) (plug) CE02-20BS-S-D (backshell) (straight) CE3057-12A-3-D (cable clamp)  Amplifier connector 36210-0100PL (receptacle, 3M) 36310-3200-008 (shell kit, 3M), or 54599-1019 (connector set, Molex)
	⑬	Encoder connector set for HF-JP11K1M, 15K1M, 11K1M4, 15K1M4 MR-ENECNS	IP67	Encoder connector (DDK) D/MS3106A20-29S(D190) (plug) CE02-20BS-S-D (backshell) (straight) CE3057-12A-3-D (cable clamp)  Amplifier connector 36210-0100PL (receptacle, 3M) 36310-3200-008 (shell kit, 3M), or 54599-1019 (connector set, Molex)
	⑭	Battery connection relay cable MR-J3BTCBL03M Cable length: 0.3m (Note 3)	—	Junction connector (3M) 36110-3000FD (plug) 36310-F200-008 (shell kit)  Amplifier connector 36210-0100PL (receptacle, 3M) 36310-3200-008 (shell kit, 3M), or 54599-1019 (connector set, Molex) Battery connector (HIROSE ELECTRIC) DF3-2EP-2C (plug) DF3-EP2428PCA (Crimping terminal for plug) 2 pcs. Not required when the servo system is used in incremental mode. Refer to "Options ● Battery connection relay cable" for details.
For servo motor power supply	⑮	Power supply cable for HF-KP/HF-MP series Lead out in direction of motor shaft MR-PWS1CBL□M-A1-H □=cable length: 2, 5, 10m (Note 1, 4)	IP65	 Motor power supply connector (Japan Aviation Electronics Industry) JN4FT04SJ1-R (plug) ST-TMH-S-C1B-100-(A534G) (socket contact) Lead-out *The cable is not shielded.
		MR-PWS1CBL□M-A1-L □=cable length: 2, 5, 10m (Note 1)	IP65	
	⑯	Power supply cable for HF-KP/HF-MP series Lead out in opposite direction of motor shaft MR-PWS1CBL□M-A2-H □=cable length: 2, 5, 10m (Note 1, 4)	IP65	
		MR-PWS1CBL□M-A2-L □=cable length: 2, 5, 10m (Note 1)	IP65	
	⑰	Power supply cable for HF-KP/HF-MP series Lead out in direction of motor shaft MR-PWS2CBL03M-A1-L Cable length: 0.3m (Note 1)	IP55	 Motor power supply connector (Japan Aviation Electronics Industry) JN4FT04SJ2-R (plug) ST-TMH-S-C1B-100-(A534G) (socket contact) Lead-out *The cable is not shielded.
		Power supply cable for HF-KP/HF-MP series Lead out in opposite direction of motor shaft MR-PWS2CBL03M-A2-L Cable length: 0.3m (Note 1)	IP55	
	⑲	Power supply connector set for HF-SP51, 81, 52, 102, 152, 524, 1024, 1524 HF-JP53, 73, 103, 153, 203, 534, 734, 1034, 1534, 2034, 3534, 5034 MR-PWCNS4 (Straight type)	IP67	 Motor power supply connector (DDK) CE05-6A18-10SD-D-BSS (plug) (straight) CE3057-10A-1-D (cable clamp) <Applicable cable example> Wire size: 2mm ² (AWG14) to 3.5mm ² (AWG12) Completed cable outer diameter: φ10.5mm to φ14.1mm
		Power supply connector set for HF-SP121, 201, 301, 202, 352, 502, 2024, 3524, 5024 HF-JP353, 503 MR-PWCNS5 (Straight type)	IP67	

- Notes: 1. -H and -L indicate a bending life. -H indicates a long bending life, and -L indicates a standard bending life.
2. The IP rating indicated is for the connector's protection against ingress of dust and water when coupled to a servo amplifier/servo motor. If the IP rating of the servo amplifier/servo motor differs from that of these connectors, overall IP rating depends on the lowest of all.
3. The battery connection relay cable (MR-J3BTCBL03M) has a diode built-in. Do not manufacture this cable. This optional cable must be used.
4. For the ultra-long bending life cables and/or for unlisted lengths (available in the ultra-long bending life cables), contact Mitsubishi Electric System & Service Co., Ltd. FA PRODUCT DIVISION by email: oss-ip@melsc.jp
5.  are available in 4-wire type. Parameter setting is required to use the 4-wire type encoder cable. Refer to "MR-J3 SERVO AMPLIFIER INSTRUCTION MANUAL" for more details.

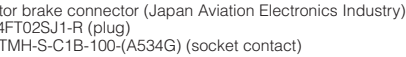
Model designation
Servo motors
Servo amplifiers
Options
Peripheral equipment
MR-J3-BSafety series
MR-J3W series
Servo support software
Cautions
Warranty
Global FA centers

Options

● Cables and connectors for servo motor

Item		Model	IP rating (Note 2)	Description
For servo motor power supply	⑲ Power supply connector set for HF-SP421, 702, 7024 HF-JP703, 903, 11K1M, 15K1M, 7034, 9034, 11K1M4, 15K1M4 HA-LP702	MR-PWCNS3 (Straight type)	IP67	 Motor power supply connector (DDK) CE05-6A32-17SD-D-BSS (plug) (straight) CE3057-20A-1-D (cable clamp) <Applicable cable example> Wire size: 14mm ² (AWG6) to 22mm ² (AWG4) Completed cable outer diameter: φ22mm to φ23.8mm
	⑳ Power supply connector set for HC-LP52, 102, 152 HC-RP103, 153, 203 HC-UP72, 152	MR-PWCNS1 (Straight type)	IP67	 Motor power supply connector (DDK) CE05-6A22-23SD-D-BSS (plug) (straight) CE3057-12A-2-D (cable clamp) <Applicable cable example> Wire size: 2mm ² (AWG14) to 3.5mm ² (AWG12) Completed cable outer diameter: φ9.5mm to φ13mm
	㉑ Power supply connector set for HC-LP202, 302 HC-RP353, 503 HC-UP202, 352, 502 HA-LP502	MR-PWCNS2 (Straight type)	IP67	 Motor power supply connector (DDK) CE05-6A24-10SD-D-BSS (plug) (straight) CE3057-16A-2-D (cable clamp) <Applicable cable example> Wire size: 5.5mm ² (AWG10) to 8mm ² (AWG8) Completed cable outer diameter: φ13mm to φ15.5mm
For servo motor electromagnetic brake	⑳ 10m or shorter (Direct connection type)	MR-BKS1CBL□M-A1-H □=cable length: 2, 5, 10m (Note 1, 3)	IP65	 Motor brake connector (Japan Aviation Electronics Industry) JN4FT02SJ1-R (plug) ST-TMH-S-C1B-100-(A534G) (socket contact)  Lead-out *The cable is not shielded.
		MR-BKS1CBL□M-A1-L □=cable length: 2, 5, 10m (Note 1)	IP65	
	㉑ Exceeding 10m (Relay type)	MR-BKS1CBL□M-A2-H □=cable length: 2, 5, 10m (Note 1, 3)	IP65	
		MR-BKS1CBL□M-A2-L □=cable length: 2, 5, 10m (Note 1)	IP65	
	㉒ Exceeding 10m (Relay type)	MR-BKS2CBL03M-A1-L Cable length: 0.3m (Note 1)	IP55	 Motor brake connector (Japan Aviation Electronics Industry) JN4FT02SJ2-R (plug) ST-TMH-S-C1B-100-(A534G) (socket contact)  Lead-out *The cable is not shielded.
		MR-BKS2CBL03M-A2-L Cable length: 0.3m (Note 1)	IP55	
	㉓ Brake connector set for HF-SP series HF-JP53B, 73B, 103B, 153B, 203B, 353B, 503B, 703B, 903B, 534B, 734B, 1034B, 1534B, 2034B, 3534B, 5034B, 7034B, 9034B	MR-BKCNS1 (Note 4) (Straight type)	IP67	 Motor brake connector (DDK) (solder type) CM10-SP2S-L(D6) (straight plug) CM10-#22SC(S2)(D8)-100 (socket contact) <Applicable cable example> Wire size: 1.25mm ² (AWG16) or smaller Completed cable outer diameter: φ9.0mm to φ11.6mm
		MR-BKCNS1A (Note 4) (Angled type)	IP67	 Motor brake connector (DDK) (solder type) CM10-AP2S-L(D6) (angled plug) CM10-#22SC(S2)(D8)-100 (socket contact) <Applicable cable example> Wire size: 1.25mm ² (AWG16) or smaller Completed cable outer diameter: φ9.0mm to φ11.6mm
		MR-BKCN (Straight type)	IP67	 Motor brake connector D/MS3106A10SL-4S(D190) (plug, DDK) YSO10-5 to 8 (cable clamp) (straight), Daiwa Dengyo <Applicable cable example> Wire size: 0.3mm ² (AWG22) to 1.25mm ² (AWG16) Completed cable outer diameter: φ5mm to φ8.3mm

- Notes: 1. -H and -L indicate a bending life. -H indicates a long bending life, and -L indicates a standard bending life.
 2. The IP rating indicated is for the connector's protection against ingress of dust and water when coupled to a servo amplifier/servo motor. If the IP rating of the servo amplifier/servo motor differs from that of these connectors, overall IP rating depends on the lowest of all.
 3. For the ultra-long bending life cables and/or for unlisted lengths (available in the ultra-long bending life cables), contact Mitsubishi Electric System & Service Co., Ltd. FA PRODUCT DIVISION by email: oss-ip@melsc.jp
 4. Select from below if there is a potential risk that a high vibration may be applied to connectors.
 Brake connector set: MR-BKCNS1-S06 (straight type) or MR-BKCNS1A-S06 (angled type)
 Connector cover: MR-J3ENS-CVR (straight type) or MR-J3ENSA-CVR (angled type)
 Be sure to use this connector cover when using the brake connector set in the table.
 Contact your local sales office for more details.

Ordering Information for Customers

To order the following products, contact the relevant manufacturers directly.

When manufacturing a cable with the following connectors, refer to the relevant manufacturers' instruction manuals for wiring and assembling procedures.

● Personal computer communication cable

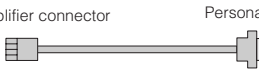
Item	Model	Description
RS-422/RS-232C conversion cable	DSV-CABV	 Amplifier connector Personal computer connector Manufacturer: Diatrend Corp.

● RS-422 connector

Item	Model	Description
RS-422 connector	TM10P-88P	 Manufacturer: HIROSE ELECTRIC CO., LTD.



● RS-422 branch connector (for multi-drop)

Item	Model	Description
Branch connector	BMJ-8	 Manufacturer: HACHIKO ELECTRIC CO., LTD.

● CC-Link twisted cable

Item	Model	Description
CC-Link twisted cable	FANC-110SBH	 Manufacturer: Mitsubishi Electric System & Service Co., Ltd. (Note 2)

● Servo amplifier power supply connectors (press bonding type) --- For 1kW or smaller

Item	Model	Description	Applicable cable example
Amplifier CNP1 connector	51241-0600 (connector) 56125-0128 (terminal)	 Manufacturer: Molex	Wire size: 0.75mm ² (AWG18) to 2.5mm ² (AWG14) Completed cable outer diameter: up to ϕ 3.8mm Crimping tool (CNP57349-5300) is required.
Amplifier CNP2 connector	51240-0500 (connector) 56125-0128 (terminal)	 Manufacturer: Molex	
Amplifier CNP3 connector	51241-0300 (connector) 56125-0128 (terminal)	 Manufacturer: Molex	

● Encoder connectors

Encoder connector (servo amplifier-side connector)

Item	Model	Description
Servo amplifier CN2 connector set (Note 1)	54599-1019 (connector set) (gray)	 Manufacturer: Molex
	54599-1016 (connector set) (black)	

For HF-KP/HF-MP series

Servo motor	Model	Feature	Description	Applicable cable example
HF-KP/HF-MP series	1674320-1	IP65 (Note 3)	 Manufacturer: Tyco Electronics Corporation	Wire size: 0.14mm ² (AWG26) to 0.3mm ² (AWG22) Completed cable outer diameter: ϕ 7.1 \pm 0.3mm Crimping tools: 1596970-1 (for ground clip) and 1596847-1 (for receptacle contact) are required. Wire example: Fluoric resin wire (Vinyl jacket cable ETFE SVP 70/0.08 (AWG#22)-3P-KB-16824 BANDO DENISEN Co., LTD. or an equivalent product)

Notes: 1. 3M also manufactures a connector compatible with the servo amplifier's CN2 connector.
 Model: 36210-0100PL (receptacle), 36310-3200-008 (shell kit).

2. Contact Mitsubishi Electric System & Service Co., Ltd. FA PRODUCT DIVISION by email: oss-ip@melsc.jp

3. The IP rating indicated is for the connector's protection against ingress of dust and water when coupled to a servo amplifier/servo motor. If the IP rating of the servo amplifier/servo motor differs from that of these connectors, overall IP rating depends on the lowest of all.

MELSERVO-J3

Ordering Information for Customers

● Encoder connectors For HF-SP/HF-JP (9kW or smaller)/HC-LP/HC-RP/HC-UP/HA-LP series

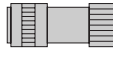
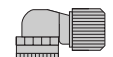
Servo motor	Connector			Contact	Feature	Description	Applicable cable example		
	Type	Plug (Note 2)	Socket contact				Wire size	Completed cable outer diameter	
HF-SP/HC-LP/ HC-RP/HC-UP/ HA-LP series/ HF-JP53, 73, 103, 153, 203, 353, 503, 703, 903 HF-JP534, 734, 1034, 1534, 2034, 3534, 5034, 7034, 9034	Straight	CM10-SP10S-M(D6)	CM10-#22SC(C1)(D8)-100	Press bonding type	IP67 (Note 1)	 <Straight type>	0.3mm ² (AWG22) to 0.5mm ² (AWG20) Crimping tool (357J-50446T) is required.	φ6.0mm to φ9.0mm	
			CM10-#22SC(C2)(D8)-100				0.08mm ² (AWG28) to 0.25mm ² (AWG23) Crimping tool (357J-50447T) is required.		
			CM10-#22SC(S1)(D8)-100	Solder type			0.5mm ² (AWG20) or smaller		
	Angled	CM10-AP10S-M(D6)	CM10-#22SC(C1)(D8)-100	Press bonding type		IP67 (Note 1)	 <Angled type>		0.3mm ² (AWG22) to 0.5mm ² (AWG20) Crimping tool (357J-50446T) is required.
			CM10-#22SC(C2)(D8)-100						0.08mm ² (AWG28) to 0.25mm ² (AWG23) Crimping tool (357J-50447T) is required.
			CM10-#22SC(S1)(D8)-100	Solder type					0.5mm ² (AWG20) or smaller

For HF-JP (11kW and 15kW) series (IP67 rated)

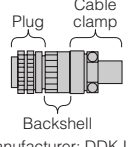
Servo motor	Plug	Backshell		Cable clamp	Feature	Description	Applicable cable example	
	Model	Type	Model	Model			Wire size	Completed cable outer diameter
HF-JP11K1M, 15K1M, HF-JP11K1M4, 15K1M4	D/MS3106A20-29S(D190)	Straight	CE02-20BS-S-D	CE3057-12A-3-D	IP67 (Note 1)	 <Straight type> Plug, Cable clamp, Backshell Manufacturer: DDK Ltd.	0.3mm ² (AWG22) to 1.25mm ² (AWG16)	φ6.8mm to φ10mm
			CE-20BA-S-D					

For HF-JP (11kW and 15kW) series (general environment)

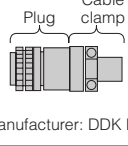

Servo motor	Plug (with backshell)		Cable clamp	Feature	Description	Applicable cable example	
	Type	Model	Model			Wire size	Completed cable outer diameter
HF-JP11K1M, 15K1M, HF-JP11K1M4, 15K1M4	Straight	D/MS3106B20-29S	D/MS3057-12A	General environment	 <Straight type> Plug, Cable clamp Manufacturer: DDK Ltd.	0.3mm ² (AWG22) to 1.25mm ² (AWG16)	φ15.9mm or smaller (Inner diameter of bushing)

- Notes: 1. The IP rating indicated is for the connector's protection against ingress of dust and water when coupled to a servo amplifier/servo motor. If the IP rating of the servo amplifier/servo motor differs from that of these connectors, overall IP rating depends on the lowest of all.
 2. Select from below if there is a potential risk that a high vibration may be applied to connectors.
 CM10-SP10S-VP-M (straight type) or CM10-AP10S-VP-M (angled type)

● Motor power supply connectors
For HF-KP/HF-MP series

Servo motor	Model	Feature	Description	Applicable cable example
HF-KP/ HF-MP series	JN4FT04SJ1-R (plug) ST-TMH-S-C1B-100-(A534G) (socket contact)	IP65 (Note 1)	 Manufacturer: Japan Aviation Electronics Industry, Ltd.	Wire size: 0.75mm ² (AWG19) Completed cable outer diameter: $\phi 6.2 \pm 0.3$ mm Crimping tool: CT160-3-TMH5B (for contact) is required. Wire example: Fluoric resin wire (Vinyl jacket cable RMFES-A (CL3X) AWG19 4 cores DYDEN CORPORATION or an equivalent product)

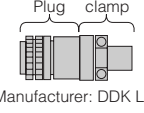
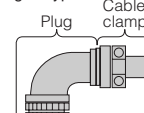
For HF-SP/HF-JP series

Servo motor	Plug (with backshell)		Cable clamp	Feature	Description	Applicable cable example	
	Type	Model	Model			Wire size	Completed cable outer diameter
HF-SP51, 81 HF-SP52, 102, 152 HF-SP524, 1024, 1524 HF-JP53, 73, 103, 153, 203, HF-JP534, 734, 1034, 1534, 2034, 3534, 5034	Straight	CE05-6A18-10SD-D-BSS	CE3057-10A-2-D	IP67 (Note 1) EN standards	 Manufacturer: DDK Ltd.	2mm ² (AWG14) to 3.5mm ² (AWG12)	$\phi 8.5$ mm to $\phi 11$ mm
			CE3057-10A-1-D				$\phi 10.5$ mm to $\phi 14.1$ mm
	Angled	CE05-8A18-10SD-D-BAS	CE3057-10A-2-D				$\phi 8.5$ mm to $\phi 11$ mm
			CE3057-10A-1-D				$\phi 10.5$ mm to $\phi 14.1$ mm
HF-SP121, 201, 301 HF-SP202, 352, 502 HF-SP2024, 3524, 5024 HF-JP353, 503	Straight	CE05-6A22-22SD-D-BSS	CE3057-12A-2-D	IP67 (Note 1) EN standards	 Manufacturer: DDK Ltd.	3.5mm ² (AWG12) to 8mm ² (AWG8)	$\phi 9.5$ mm to $\phi 13$ mm
			CE3057-12A-1-D				$\phi 12.5$ mm to $\phi 16$ mm
	Angled	CE05-8A22-22SD-D-BAS	CE3057-12A-2-D				$\phi 9.5$ mm to $\phi 13$ mm
			CE3057-12A-1-D				$\phi 12.5$ mm to $\phi 16$ mm
HF-SP421, 702 HF-SP7024 HF-JP703, 903, 11K1M, 15K1M, 7034, 9034, 11K1M4, 15K1M4	Straight	CE05-6A32-17SD-D-BSS	CE3057-20A-1-D	IP67 (Note 1) EN standards	 Manufacturer: DDK Ltd.	14mm ² (AWG6) to 22mm ² (AWG4)	$\phi 22$ mm to $\phi 23.8$ mm
			CE3057-20A-1-D				$\phi 22$ mm to $\phi 23.8$ mm
	Angled	CE05-8A32-17SD-D-BAS	CE3057-20A-1-D				$\phi 23.8$ mm or smaller (Inner diameter of bushing)
			CE3057-20A-1-D				$\phi 23.8$ mm or smaller (Inner diameter of bushing)
Straight	D/MS3106B22-22S	D/MS3057-12A	General environment (Note 2)	General environment (Note 2)			
			General environment (Note 2)				
Angled	D/MS3108B22-22S	D/MS3057-12A	General environment (Note 2)	General environment (Note 2)			
			General environment (Note 2)				

For HF-JP (200V 15kW) series (IP67 rated)

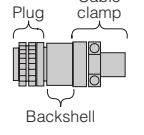
Servo motor	Plug	Backshell		Cable clamp	Feature	Description	Applicable cable example	
	Model	Type	Model	Model			Wire size	Completed cable outer diameter
HF-JP15K1M	CE05-6A32-17SD-D	Straight	CE05-32BS-S-D-OB	CE3057-24A-1-D	IP67 (Note 1)	 Manufacturer: DDK Ltd.	22mm ² (AWG4)	$\phi 30$ mm to $\phi 32.5$ mm
				CE3057-24A-2-D				$\phi 27.5$ mm to $\phi 29.6$ mm

For HC-LP/HC-RP/HC-UP series or HA-LP502/702

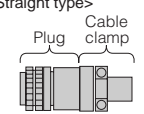
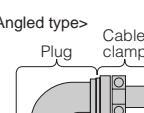
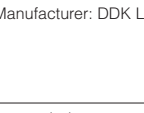
Servo motor	Plug (with backshell)		Cable clamp	Feature	Description	Applicable cable example	
	Type	Model	Model			Wire size	Completed cable outer diameter
HC-LP52, 102, 152 HC-RP103, 153, 203 HC-UP72, 152	Straight	CE05-6A22-23SD-D-BSS	CE3057-12A-2-D	IP67 (Note 1) EN standards	 Manufacturer: DDK Ltd.	2mm ² (AWG14) to 3.5mm ² (AWG12)	$\phi 9.5$ mm to $\phi 13$ mm
			CE3057-12A-1-D				$\phi 12.5$ mm to $\phi 16$ mm
	Angled	CE05-8A22-23SD-D-BAS	CE3057-12A-2-D				$\phi 9.5$ mm to $\phi 13$ mm
			CE3057-12A-1-D				$\phi 12.5$ mm to $\phi 16$ mm
HC-LP202, 302 HC-RP353, 503 HC-UP202, 352, 502 HA-LP502	Straight	CE05-6A24-10SD-D-BSS	CE3057-16A-2-D	IP67 (Note 1) EN standards	 Manufacturer: DDK Ltd.	5.5mm ² (AWG10) to 8mm ² (AWG8)	$\phi 13$ mm to $\phi 15.5$ mm
			CE3057-16A-1-D				$\phi 15$ mm to $\phi 19.1$ mm
	Angled	CE05-8A24-10SD-D-BAS	CE3057-16A-2-D				$\phi 13$ mm to $\phi 15.5$ mm
			CE3057-16A-1-D				$\phi 15$ mm to $\phi 19.1$ mm
HA-LP702	Straight	CE05-6A32-17SD-D-BSS	CE3057-20A-1-D	IP67 (Note 1) EN standards	 Manufacturer: DDK Ltd.	14mm ² (AWG6) to 22mm ² (AWG4)	$\phi 22$ mm to $\phi 23.8$ mm
			CE3057-20A-1-D				$\phi 22$ mm to $\phi 23.8$ mm
	Angled	CE05-8A32-17SD-D-BAS	CE3057-20A-1-D				$\phi 23.8$ mm or smaller (Inner diameter of bushing)
			CE3057-20A-1-D				$\phi 23.8$ mm or smaller (Inner diameter of bushing)
Straight	D/MS3106B24-10S	D/MS3057-16A	General environment (Note 2)	General environment (Note 2)			
			General environment (Note 2)				
Angled	D/MS3108B24-10S	D/MS3057-16A	General environment (Note 2)	General environment (Note 2)			
			General environment (Note 2)				

Notes: 1. The IP rating indicated is for the connector's protection against ingress of dust and water when coupled to a servo amplifier/servo motor. If the IP rating of the servo amplifier/servo motor differs from that of these connectors, overall IP rating depends on the lowest of all.
2. Not compliant with EN standards.

Model designation
Servo motors
Servo amplifiers
Options
Peripheral equipment
MR-J3-BSafety series
MR-J3W series
Servo support software
Cautions
Warranty
Global FA centers

MELSERVO-J3

Ordering Information for Customers

● Motor brake connectors For HF-KP/HF-MP series

Servo motor	Model	Feature	Description	Applicable cable example
HF-KP/ HF-MP series	JN4FT02SJ1-R (plug) ST-TMH-S-C1B-100-(A534G) (socket contact)	IP65 (Note 1)	 Manufacturer: Japan Aviation Electronics Industry, Ltd.	Wire size: 0.5mm ² (AWG20) Completed cable outer diameter: $\phi 4.5 \pm 0.3$ mm Crimping tool: CT160-3-TMH5B (for contact) is required. Wire example: Fluoric resin wire (Vinyl jacket cable RMFES-A (CL3X) AWG20 2 cores DYDEN CORPORATION or an equivalent product)

For HF-SP/HF-JP (9kW or smaller) series

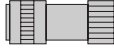
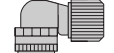
Servo motor	Connector			Contact	Feature	Description	Applicable cable example		
	Type	Plug (Note 2)	Socket contact				Wire size	Completed cable outer diameter	
HF-SP series HF-JP53B, 73B, 103B, 153B, 203B, 353B, 503B, 703B, 903B HF-JP534B, 734B, 1034B, 1534B, 2034B, 3534B, 5034B, 7034B, 9034B	Straight	CM10-SP2S-S(D6)	CM10-#22SC(S2)(D8)-100	Solder type	IP67 (Note 1)	<Straight type> 	1.25mm ² (AWG16) or smaller	$\phi 4.0$ mm to $\phi 6.0$ mm	
		CM10-SP2S-M(D6)						$\phi 6.0$ mm to $\phi 9.0$ mm	
		CM10-SP2S-L(D6)		$\phi 9.0$ mm to $\phi 11.6$ mm					
		CM10-SP2S-S(D6)		$\phi 4.0$ mm to $\phi 6.0$ mm					
		CM10-SP2S-M(D6)		$\phi 6.0$ mm to $\phi 9.0$ mm					
	Angled	CM10-AP2S-S(D6)	CM10-#22SC(S2)(D8)-100	Press bonding type		IP67 (Note 1)	<Angled type> 	0.5mm ² (AWG20) to 1.25mm ² (AWG16) Crimping tool (357J-50448T) is required.	$\phi 4.0$ mm to $\phi 6.0$ mm
		CM10-AP2S-M(D6)							$\phi 6.0$ mm to $\phi 9.0$ mm
		CM10-AP2S-L(D6)		$\phi 9.0$ mm to $\phi 11.6$ mm					
		CM10-AP2S-S(D6)		$\phi 4.0$ mm to $\phi 6.0$ mm					
		CM10-AP2S-M(D6)		$\phi 6.0$ mm to $\phi 9.0$ mm					
CM10-AP2S-L(D6)	$\phi 9.0$ mm to $\phi 11.6$ mm								

HF-JP(11kW and 15kW)/HC-LP/HC-UP/HA-LP series (IP67 rated)

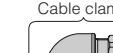
Servo motor	Plug	Cable clamp (with backshell)			Feature	Description	Applicable cable example	
	Model · Manufacturer	Type	Model	Manufacturer			Wire size	Completed cable outer diameter
HF-JP11K1MB, 15K1MB HF-JP11K1M4B, 15K1M4B HC-LP202B, 302B HC-UP202B, 352B, 502B HA-LP601B, 801B, 12K1B, 6014B, 8014B, 12K14B HA-LP701MB, 11K1MB, 15K1MB, 701M4B, 11K1M4B, 15K1M4B HA-LP11K2B, 15K2B, 22K2B, 11K24B, 15K24B, 22K24B	D/MS3106A10SL-4S(D190) Manufacturer: DDK Ltd.	Straight	ACS-08RL-MS10F	NIPPON FLEX CO., LTD.	IP67 (Note 1)	<Straight type> 	0.3mm ² (AWG22) to 1.25mm ² (AWG16)	$\phi 4$ mm to $\phi 8$ mm
			ACS-12RL-MS10F	$\phi 8$ mm to $\phi 12$ mm				
			YSO10-5 to 8	DAIWA DENGYO CO., LTD.				$\phi 5$ mm to $\phi 8.3$ mm
		Angled	ACA-08RL-MS10F	NIPPON FLEX CO., LTD.		<Angled type> 	$\phi 4$ mm to $\phi 8$ mm	
			ACA-12RL-MS10F	$\phi 8$ mm to $\phi 12$ mm				
			YLO10-5 to 8	DAIWA DENGYO CO., LTD.			$\phi 5$ mm to $\phi 8.3$ mm	

HF-JP(11kW and 15kW)/HC-LP/HC-UP/HA-LP series (general environment)

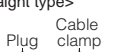
Servo motor	Plug (with backshell)		Cable clamp	Feature	Description	Applicable cable example	
	Type	Model	Model			Wire size	Completed cable outer diameter
HF-JP11K1MB, 15K1MB HF-JP11K1M4B, 15K1M4B HC-LP202B, 302B HC-UP202B, 352B, 502B HA-LP601B, 801B, 12K1B, 6014B, 8014B, 12K14B HA-LP701MB, 11K1MB, 15K1MB, 701M4B, 11K1M4B, 15K1M4B HA-LP11K2B, 15K2B, 22K2B, 11K24B, 15K24B, 22K24B	Straight	D/MS3106A10SL-4S	D/MS3057-4A	General environment	<Straight type>  Manufacturer: DDK Ltd.	0.3mm ² (AWG22) to 1.25mm ² (AWG16)	$\phi 5.6$ mm or smaller (Inner diameter of bushing)

- Notes: 1. The IP rating indicated is for the connector's protection against ingress of dust and water when coupled to a servo amplifier/servo motor. If the IP rating of the servo amplifier/servo motor differs from that of these connectors, overall IP rating depends on the lowest of all.
2. Select from below if there is a potential risk that a high vibration may be applied to connectors.
CM10-SP2S-VP-S/M/L (straight type) or CM10-AP2S-VP-S/M/L (angled type)

RoHS Compliant Connectors

● Optional connector set for servo amplifier

The following connector sets have been changed to RoHS compliant since September 2006.

Only the components of the connector set that have changed are listed below.

Connector set	Non-RoHS compliant component	RoHS compliant component
MR-J3SCNS MR-ECNM MR-J3CN2	36210-0100JL (receptacle) (Note 1) (3M or an equivalent product)	36210-0100PL (receptacle) (3M or an equivalent product)
MR-PWCNS4	CE05-6A18-10SD-B-BSS (connector and backshell) (DDK) CE3057-10A-1(D265) (cable clamp) (DDK)	CE05-6A18-10SD-D-BSS (connector and backshell) (DDK) CE3057-10A-1-D (cable clamp) (DDK)
MR-PWCNS5	CE05-6A22-22SD-B-BSS (connector and backshell) (DDK) CE3057-12A-1(D265) (cable clamp) (DDK)	CE05-6A22-22SD-D-BSS (connector and backshell) (DDK) CE3057-12A-1-D (cable clamp) (DDK)
MR-PWCNS3	CE05-6A32-17SD-B-BSS (connector and backshell) (DDK) CE3057-20A-1(D265) (cable clamp) (DDK)	CE05-6A32-17SD-D-BSS (connector and backshell) (DDK) CE3057-20A-1-D (cable clamp) (DDK)
MR-PWCNS1	CE05-6A22-23SD-B-BSS (connector and backshell) (DDK) CE3057-12A-2(D265) (cable clamp) (DDK)	CE05-6A22-23SD-D-BSS (connector and backshell) (DDK) CE3057-12A-2-D (cable clamp) (DDK)
MR-PWCNS2	CE05-6A24-10SD-B-BSS (connector and backshell) (DDK) CE3057-16A-2(D265) (cable clamp) (DDK)	CE05-6A24-10SD-D-BSS (connector and backshell) (DDK) CE3057-16A-2-D (cable clamp) (DDK)
MR-BKCN	MS3106A10SL-4S(D190) (plug) (DDK)	D/MS3106A10SL-4S(D190) (plug) (DDK)
MR-CCN1	10120-3000VE (connector) (3M or an equivalent product)	10120-3000PE (connector) (3M or an equivalent product)
MR-J3CN1	10150-3000VE (connector) (3M or an equivalent product)	10150-3000PE (connector) (3M or an equivalent product)
MR-J2CMP2	10126-3000VE (connector) (3M or an equivalent product)	10126-3000PE (connector) (3M or an equivalent product)
MR-J2CN1-A	10120-3000VE (connector) (3M or an equivalent product) PCR-S20FS (connector) (HONDA TSUSHIN KOGYO)	10120-3000PE (connector) (3M or an equivalent product) PCR-S20FS + (connector) (HONDA TSUSHIN KOGYO)

Notes: 1. RoHS compliant 36210-0100FD is partly packed.

● Recommended connectors

The following recommended connectors have been changed to RoHS compliant. Contact the manufacturers for more details.

Connectors	Non-RoHS compliant product	RoHS compliant product	Manufacture	
Amplifier power supply connector (for CNP1, CNP2, CNP3)	56125-0118 (terminal)	56125-0128 (terminal)	Molex	
Servo motor power supply connector	Plug	JN4FT04SJ1	Japan Aviation Electronics Industry	
	Plug (straight)	CE05-6A18-10SD-B-BSS	CE05-6A18-10SD-D-BSS	DDK
		CE05-6A22-22SD-B-BSS	CE05-6A22-22SD-D-BSS	
		CE05-6A22-23SD-B-BSS	CE05-6A22-23SD-D-BSS	
		CE05-6A32-17SD-B-BSS	CE05-6A32-17SD-D-BSS	
		CE05-6A24-10SD-B-BSS	CE05-6A24-10SD-D-BSS	
		MS3106B18-10S	D/MS3106B18-10S	
		MS3106B22-22S	D/MS3106B22-22S	
		MS3106B22-23S	D/MS3106B22-23S	
		MS3106B24-10S	D/MS3106B24-10S	
		MS3106B32-17S	D/MS3106B32-17S	
	Plug (angled)	CE05-8A18-10SD-B-BAS	CE05-8A18-10SD-D-BAS	
		CE05-8A22-22SD-B-BAS	CE05-8A22-22SD-D-BAS	
		CE05-8A32-17SD-B-BAS	CE05-8A32-17SD-D-BAS	
		CE05-8A22-23SD-B-BAS	CE05-8A22-23SD-D-BAS	
		CE05-8A24-10SD-B-BAS	CE05-8A24-10SD-D-BAS	
		MS3108B18-10S	D/MS3108B18-10S	
		MS3108B22-22S	D/MS3108B22-22S	
		MS3108B22-23S	D/MS3108B22-23S	
		MS3108B24-10S	D/MS3108B24-10S	
		MS3108B32-17S	D/MS3108B32-17S	
	Cable clamp	CE3057-10A-1(D265)	CE3057-10A-1-D	
		CE3057-10A-2(D265)	CE3057-10A-2-D	
		CE3057-12A-1(D265)	CE3057-12A-1-D	
		CE3057-12A-2(D265)	CE3057-12A-2-D	
		CE3057-16A-1(D265)	CE3057-16A-1-D	
		CE3057-16A-2(D265)	CE3057-16A-2-D	
CE3057-20A-1(D265)		CE3057-20A-1-D		
MS3057-10A		D/MS3057-10A		
MS3057-12A		D/MS3057-12A		
MS3057-16A		D/MS3057-16A		
MS3057-20A	D/MS3057-20A			
Servo motor electromagnetic brake connector	Plug	MS3106A10SL-4S(D190) MS3106A10SL-4S JN4FT02SJ1	Japan Aviation Electronics Industry	
	Cable clamp	D/MS3106A10SL-4S(D190) D/MS3106A10SL-4S	DDK	
		JN4FT02SJ1-R D/MS3057-4A		

MELSERVO-J3

Options

● Dynamic brake

Use an optional external dynamic brake with the 11kW or larger servo amplifier. Without the external dynamic brake, a servo motor does not stop immediately at emergency stop and falls in free-run status, causing an accident such as machine collision, etc. Take measures to ensure safety on the entire system.

Model	Servo amplifier	Fig.	Model	Drive unit	Fig.
DBU-11K	MR-J3-11KA/B/T	A	DBU-37K	MR-J3-DU30KA/B	C
DBU-15K	MR-J3-15KA/B/T			MR-J3-DU37KA/B	
DBU-22K	MR-J3-22KA/B/T				
DBU-11K-4	MR-J3-11KA4/B4/T4	B	DBU-55K-4	MR-J3-DU30KA4/B4	
DBU-15K-4	MR-J3-15KA4/B4/T4			MR-J3-DU37KA4/B4	
DBU-22K-4	MR-J3-22KA4/B4/T4			MR-J3-DU45KA4/B4	
				MR-J3-DU55KA4/B4	

External dimensions (Unit: mm)										Connections									
<p>Terminal arrangement Screw size: M3.5 < Mounting screw size > M4</p>																			
Model	A	B	C	D	E	F	G	Mass kg (lb)	Electrical wire size (mm ²)										
DBU-11K	200	190	140	20	5	170	163.5	2 (4.4)	5.5 (AWG10)										
DBU-15K	250	238	150	25	6	235	228	6 (13)	5.5 (AWG10)										
DBU-22K																			
<p>TE1 Screw size: M3.5 TE2 Screw size: M4 < Mounting screw size > M6</p>																			
Model	Mass kg (lb)	Electrical wire size (mm ²)																	
		U, V, W	Other than U, V, W																
DBU-11K-4	6.7	5.5	2																
DBU-22K-4	(15)	(AWG10)	(AWG14)																
<p>TE1 Screw size: M5 TE2 Screw size: M3.5 < Mounting screw size > M8</p>																			
Model	Mass kg (lb)	Electrical wire size (mm ²)																	
		U, V, W	Other than U, V, W																
DBU-37K	8 (18)	14	2																
DBU-55K-4	11 (24)	(AWG6)	(AWG14)																

- Notes: 1. The connection diagrams Fig.A and B are for MR-J3-□(B4) and Fig.C for MR-J3-DU□(B4). For connection diagram for MR-J3-□(A4) or MR-J3-DU□(A4), refer to "MR-J3-□A SERVO AMPLIFIER INSTRUCTION MANUAL".
2. Validate the dynamic brake interlock (DB) signal by parameter No. PD07 to PD09 for MR-J3-□(B4) or MR-J3-DU□(B4).
3. The terminals 13 and 14 are normally opened outputs. If the dynamic brake is welded, the terminals 13 and 14 will be opened. So, create the external sequence circuit that the servo-on (SON) signal does not turn on when the terminals 13 and 14 are opened.
4. A step-down transformer is required when coil voltage of the magnetic contactor (MC) is 200V class, and the servo amplifier, the converter unit and the drive unit are 400V class.
5. Create a circuit that validates the forced stop (EM1) signals of the drive unit and the converter unit at the same time.
6. When using DBU-11K-4 or DBU-22K-4, the power supply must be between 1-phase 380VAC to 463VAC 50/60Hz. Refer to "MR-J3 SERVO AMPLIFIER MANUAL" for details.

● **Optional regeneration unit (200VAC)**

Servo amplifier/drive unit model (MR-J3-)	Tolerable regenerative power of built-in regenerative resistor (W)	Tolerable regenerative power of optional regeneration unit (W) (Note 4)																
		GRZG400-					MR-RB											
		1.5Ω X 4 (Note 2)	0.8Ω X 4 (Note 2)	0.9Ω X 5 (Note 2)	0.6Ω X 5 (Note 2)	032 [40Ω]	12 [40Ω]	30 [13Ω]	31 [6.7Ω]	32 [40Ω]	50 [13Ω] (Note 1)	51 [6.7Ω] (Note 1)	5E [6Ω] (Note 2)	5R [3.2Ω] (Note 2)	9P [4.5Ω] (Note 2)	9F [3Ω] (Note 2)	139 [1.3Ω]	137 [1.3Ω] (Note 3)
10A(1)/B(1)/T(1)	–	–	–	–	–	30	–	–	–	–	–	–	–	–	–	–	–	–
20A(1)/B(1)/T(1)	10	–	–	–	–	30	100	–	–	–	–	–	–	–	–	–	–	–
40A(1)/B(1)/T(1)	10	–	–	–	–	30	100	–	–	–	–	–	–	–	–	–	–	–
60A/B/T	10	–	–	–	–	30	100	–	–	–	–	–	–	–	–	–	–	–
70A/B/T	20	–	–	–	–	30	100	–	–	300	–	–	–	–	–	–	–	–
100A/B/T	20	–	–	–	–	30	100	–	–	300	–	–	–	–	–	–	–	–
200A(N)/B(N)/T(N)	100	–	–	–	–	–	–	300	–	–	500	–	–	–	–	–	–	–
350A/B/T	100	–	–	–	–	–	–	300	–	–	500	–	–	–	–	–	–	–
500A/B/T	130	–	–	–	–	–	–	–	300	–	–	500	–	–	–	–	–	–
700A/B/T	170	–	–	–	–	–	–	–	300	–	–	500	–	–	–	–	–	–
11KA/B/T	–	500 (800)	–	–	–	–	–	–	–	–	–	–	500 (800)	–	–	–	–	–
11KA/B/T-LR	–	–	500 (800)	–	–	–	–	–	–	–	–	–	500 (800)	–	–	–	–	–
15KA/B/T	–	–	–	850 (1300)	–	–	–	–	–	–	–	–	–	850 (1300)	–	–	–	–
15KA/B/T-LR	–	–	–	–	850 (1300)	–	–	–	–	–	–	–	–	–	850 (1300)	–	–	–
22KA/B/T	–	–	–	–	850 (1300)	–	–	–	–	–	–	–	–	–	850 (1300)	–	–	–
DU30KA/B	–	–	–	–	–	–	–	–	–	–	–	–	–	–	–	1300	3900	–
DU37KA/B	–	–	–	–	–	–	–	–	–	–	–	–	–	–	–	1300	3900	–

Notes: 1. Be sure to cool the unit forcibly with a cooling fan (92 X 92mm, minimum air flow: 1.0m³/min). The cooling fan must be prepared by user.
 2. The values in () indicate when cooling fans (2 units of 92 X 92mm, minimum air flow: 1.0m³/min) are installed, and parameter No. PA02 is changed.
 3. For MR-RB137, the value is applicable when 3 units of the regeneration units are used.
 4. The power values in this table are resistor-generated powers, not rated powers.

● **Optional regeneration unit (400VAC)**

Servo amplifier/drive unit model (MR-J3-)	Tolerable regenerative power of built-in regenerative resistor (W)	Tolerable regenerative power of optional regeneration unit (W) (Note 5)																
		GRZG400-					MR-RB											
		5Ω X 4 (Note 2)	2.5Ω X 4 (Note 2)	2.5Ω X 5 (Note 2)	2Ω X 5 (Note 2)	1H-4 [82Ω]	3M-4 [120Ω] (Note 1)	3G-4 [47Ω] (Note 1)	34-4 [26Ω] (Note 1)	5G-4 [47Ω] (Note 1)	54-4 [26Ω] (Note 1)	5K-4 [10Ω] (Note 2)	6B-4 [20Ω] (Note 2)	60-4 [12.5Ω] (Note 2)	6K-4 [10Ω] (Note 2)	136-4 [5Ω]	138-4 [5Ω] (Note 3)	
60A4/B4/T4	15	–	–	–	–	100	300	–	–	–	–	–	–	–	–	–	–	–
100A4/B4/T4	15	–	–	–	–	100	300	–	–	–	–	–	–	–	–	–	–	–
200A4/B4/T4	100	–	–	–	–	–	–	300	–	500	–	–	–	–	–	–	–	–
350A4/B4/T4	100	–	–	–	–	–	–	300	–	500	–	–	–	–	–	–	–	–
500A4/B4/T4	130 (Note 4)	–	–	–	–	–	–	–	300	–	500	–	–	–	–	–	–	–
700A4/B4/T4	170 (Note 4)	–	–	–	–	–	–	–	300	–	500	–	–	–	–	–	–	–
11KA4/B4/T4	–	500 (800)	–	–	–	–	–	–	–	–	–	–	500 (800)	–	–	–	–	–
11KA4/B4/T4-LR	–	–	500 (800)	–	–	–	–	–	–	–	–	–	500 (800)	–	–	–	–	–
15KA4/B4/T4	–	–	–	850 (1300)	–	–	–	–	–	–	–	–	–	850 (1300)	–	–	–	–
15KA4/B4/T4-LR	–	–	–	–	850 (1300)	–	–	–	–	–	–	–	–	–	850 (1300)	–	–	–
22KA4/B4/T4	–	–	–	–	850 (1300)	–	–	–	–	–	–	–	–	–	850 (1300)	–	–	–
DU30KA4/B4	–	–	–	–	–	–	–	–	–	–	–	–	–	–	–	1300	3900	–
DU37KA4/B4	–	–	–	–	–	–	–	–	–	–	–	–	–	–	–	1300	3900	–
DU45KA4/B4	–	–	–	–	–	–	–	–	–	–	–	–	–	–	–	1300	3900	–
DU55KA4/B4	–	–	–	–	–	–	–	–	–	–	–	–	–	–	–	1300	3900	–

Notes: 1. Be sure to cool the unit forcibly with a cooling fan (92 X 92mm, minimum air flow: 1.0m³/min). The cooling fan must be prepared by user.
 2. The values in () indicate when cooling fans (2 units of 92 X 92mm, minimum air flow: 1.0m³/min) are installed, and parameter No. PA02 is changed.
 3. For MR-RB138-4, the value is applicable when 3 units of the regeneration units are used.
 4. The servo amplifier built-in regenerative resistor is compatible with the maximum torque deceleration when the motor is used within the rated speed and the recommended load to motor inertia moment ratio.
 Contact your local sales office if the operating motor speed and the load to motor inertia moment ratio exceed the rated speed and the recommended ratio.
 5. The power values in this table are resistor-generated powers, not rated powers.

***Cautions when connecting the optional regeneration unit**

- The optional regeneration unit causes a temperature rise of 100°C or more relative to the ambient temperature. Fully examine heat dissipation, installation position, wires used, etc. before installing the unit. Use flame-retardant wires or apply flame retardant on wires. Keep the wires clear of the unit.
- Always use twisted wires, maximum length of 5m, to connect the optional regeneration unit with the servo amplifier.
- Always use twisted wires for a thermal sensor, and make sure that the sensor does not fail to work properly due to inducted noise.

MELSERVO-J3

Options

● Optional regeneration unit

External dimensions (Unit: mm)	Connections																												
<p>● MR-RB032, MR-RB12 (200VAC)</p> <p>Applicable wire size: 0.2mm² (AWG24) to 2.5mm² (AWG12)</p> <table border="1"> <thead> <tr> <th rowspan="2">Model</th> <th colspan="4">Variable dimensions</th> <th rowspan="2">Mass kg (lb)</th> </tr> <tr> <th>LA</th> <th>LB</th> <th>LC</th> <th>LD</th> </tr> </thead> <tbody> <tr> <td>MR-RB032</td> <td>30</td> <td>119</td> <td>99</td> <td>1.6</td> <td>0.5 (1.1)</td> </tr> <tr> <td>MR-RB12</td> <td>40</td> <td>169</td> <td>149</td> <td>2</td> <td>1.1 (2.4)</td> </tr> </tbody> </table>	Model	Variable dimensions				Mass kg (lb)	LA	LB	LC	LD	MR-RB032	30	119	99	1.6	0.5 (1.1)	MR-RB12	40	169	149	2	1.1 (2.4)							
Model		Variable dimensions					Mass kg (lb)																						
	LA	LB	LC	LD																									
MR-RB032	30	119	99	1.6	0.5 (1.1)																								
MR-RB12	40	169	149	2	1.1 (2.4)																								
<p>● MR-RB1H-4 (400VAC)</p> <p>Applicable wire size: 0.2mm² (AWG24) to 4.0mm² (AWG10)</p> <table border="1"> <thead> <tr> <th>Model</th> <th>Mass kg (lb)</th> </tr> </thead> <tbody> <tr> <td>MR-RB1H-4</td> <td>1.1 (2.4)</td> </tr> </tbody> </table>	Model	Mass kg (lb)	MR-RB1H-4	1.1 (2.4)																									
Model	Mass kg (lb)																												
MR-RB1H-4	1.1 (2.4)																												
<p>● MR-RB30, MR-RB31, MR-RB32 (200VAC) ● MR-RB3M-4, MR-RB3G-4, MR-RB34-4 (400VAC)</p> <p>Terminal screw size: M4</p> <table border="1"> <thead> <tr> <th rowspan="2">Model</th> <th colspan="2">Variable dimensions</th> <th rowspan="2">Mass kg (lb)</th> </tr> <tr> <th>A</th> <th>B</th> </tr> </thead> <tbody> <tr> <td>MR-RB30</td> <td></td> <td></td> <td rowspan="3">2.9 (6.4)</td> </tr> <tr> <td>MR-RB31</td> <td>17</td> <td>335</td> </tr> <tr> <td>MR-RB32</td> <td></td> <td></td> </tr> <tr> <td>MR-RB3M-4</td> <td>23</td> <td>341</td> <td></td> </tr> <tr> <td>MR-RB3G-4</td> <td></td> <td></td> <td></td> </tr> <tr> <td>MR-RB34-4</td> <td></td> <td></td> <td></td> </tr> </tbody> </table>	Model	Variable dimensions		Mass kg (lb)	A	B	MR-RB30			2.9 (6.4)	MR-RB31	17	335	MR-RB32			MR-RB3M-4	23	341		MR-RB3G-4				MR-RB34-4				<p>● MR-J3-350□ or smaller ● MR-J3-200□4 or smaller</p>
Model		Variable dimensions			Mass kg (lb)																								
	A	B																											
MR-RB30			2.9 (6.4)																										
MR-RB31	17	335																											
MR-RB32																													
MR-RB3M-4	23	341																											
MR-RB3G-4																													
MR-RB34-4																													
<p>● MR-RB50, MR-RB51 (200VAC) ● MR-RB5G-4, MR-RB54-4 (400VAC)</p> <p>Terminal screw size: M4</p> <table border="1"> <thead> <tr> <th rowspan="2">Model</th> <th colspan="2">Variable dimensions</th> <th rowspan="2">Mass kg (lb)</th> </tr> <tr> <th>A</th> <th>B</th> </tr> </thead> <tbody> <tr> <td>MR-RB50</td> <td>17</td> <td>217</td> <td rowspan="4">5.6 (12)</td> </tr> <tr> <td>MR-RB51</td> <td></td> <td></td> </tr> <tr> <td>MR-RB5G-4</td> <td>23</td> <td>223</td> </tr> <tr> <td>MR-RB54-4</td> <td></td> <td></td> </tr> </tbody> </table>	Model	Variable dimensions		Mass kg (lb)	A	B	MR-RB50	17	217	5.6 (12)	MR-RB51			MR-RB5G-4	23	223	MR-RB54-4			<p>● MR-J3-500□, 700□ ● MR-J3-350□4 to 700□4</p>									
Model		Variable dimensions			Mass kg (lb)																								
	A	B																											
MR-RB50	17	217	5.6 (12)																										
MR-RB51																													
MR-RB5G-4	23	223																											
MR-RB54-4																													

- Notes: 1. Create a sequence circuit that turns off the magnetic contactor (MC) when abnormal overheating occurs.
 2. When using MR-RB3M-4, MR-RB3G-4, MR-RB34-4, MR-RB50, MR-RB51, MR-RB5G-4 or MR-RB54-4, cool the unit forcibly with a cooling fan (92 × 92mm, minimum air flow: 1.0m³/min). The cooling fan must be prepared by user.
 3. The G3 and G4 terminals are thermal sensor. G3-G4 opens when the regeneration unit overheats abnormally.

MELSERVO-J3

Options

● Optional regeneration unit

External dimensions (Unit: mm)	Connections																													
<p>● MR-RB139, MR-RB137 (200VAC) ● MR-RB136-4, MR-RB138-4 (400VAC)</p> <div style="display: flex; justify-content: space-around; margin-top: 20px;"> <div style="text-align: center;"> <p><Terminal arrangement (200VAC)></p> <table border="1" style="border-collapse: collapse;"> <tr> <td style="padding: 2px;">TE1</td> <td style="padding: 2px;">R</td> <td style="padding: 2px;">S</td> <td style="padding: 2px;">G4</td> <td style="padding: 2px;">G3</td> <td style="padding: 2px;">C</td> <td style="padding: 2px;">P</td> </tr> </table> <p>Terminal screw size: M5</p> </div> <div style="text-align: center;"> <p><Terminal arrangement (400VAC)></p> <table border="1" style="border-collapse: collapse;"> <tr> <td style="padding: 2px;">TE1</td> <td style="padding: 2px;">R400</td> <td style="padding: 2px;">S400</td> <td style="padding: 2px;">G4</td> <td style="padding: 2px;">G3</td> <td style="padding: 2px;">C</td> <td style="padding: 2px;">P</td> </tr> </table> <p>Terminal screw size: M5</p> <p>Mounting screw size: M8</p> </div> </div> <div style="margin-top: 20px;"> <table border="1" style="width: 100%; border-collapse: collapse; text-align: center;"> <thead> <tr> <th>Model</th> <th>Tolerable regenerative power (W)</th> <th>Mass kg (lb)</th> </tr> </thead> <tbody> <tr> <td>MR-RB139</td> <td>1300</td> <td>10 (22)</td> </tr> <tr> <td>MR-RB137</td> <td>3900 (3 units are required.) (Note 2)</td> <td>11 (24)</td> </tr> <tr> <td>MR-RB136-4</td> <td>1300</td> <td>10 (22)</td> </tr> <tr> <td>MR-RB138-4</td> <td>3900 (3 units are required.) (Note 2)</td> <td>11 (24)</td> </tr> </tbody> </table> </div>	TE1	R	S	G4	G3	C	P	TE1	R400	S400	G4	G3	C	P	Model	Tolerable regenerative power (W)	Mass kg (lb)	MR-RB139	1300	10 (22)	MR-RB137	3900 (3 units are required.) (Note 2)	11 (24)	MR-RB136-4	1300	10 (22)	MR-RB138-4	3900 (3 units are required.) (Note 2)	11 (24)	<p>● MR-RB139 ● MR-RB136-4</p> <p style="font-size: small; margin-top: 10px;">*Create an external sequence circuit that turns off the main circuit contactor of the converter unit when the normally closed thermal sensor contact in the optional regeneration unit opens due to overheating.</p>
TE1	R	S	G4	G3	C	P																								
TE1	R400	S400	G4	G3	C	P																								
Model	Tolerable regenerative power (W)	Mass kg (lb)																												
MR-RB139	1300	10 (22)																												
MR-RB137	3900 (3 units are required.) (Note 2)	11 (24)																												
MR-RB136-4	1300	10 (22)																												
MR-RB138-4	3900 (3 units are required.) (Note 2)	11 (24)																												
	<p>● MR-RB137 ● MR-RB138-4</p> <p style="font-size: small; margin-top: 10px;">*Create an external sequence circuit that turns off the main circuit contactor of the converter unit when the normally closed thermal sensor contact in the optional regeneration unit opens due to overheating.</p>																													

- Notes:
1. One unit of cooling fan is attached for MR-RB136-4 or MR-RB138-4.
 2. Three units of MR-RB137 or MR-RB138-4 are required per converter unit.
 3. Connect the optional regeneration unit to the converter unit. The cable length between the regeneration unit and the converter unit must be 5m or shorter.
 4. When using the DC reactor, disconnect the short bar between P1 and P2.

● Battery (MR-J3BAT)

The absolute position data can be retained by mounting the battery on the servo amplifier.
The battery is not required when the servo system is used in incremental mode.

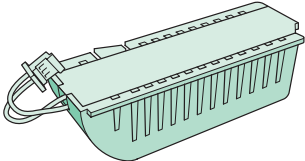
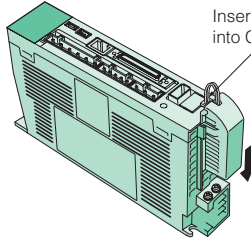
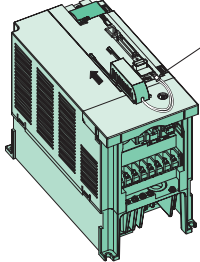
Appearance	Installation method
 <p>Model: MR-J3BAT Nominal voltage: 3.6V Nominal capacity: 2000mAh Lithium content: 0.65g Primary battery: ER6</p>	<ul style="list-style-type: none"> ● MR-J3-350□ or smaller ● MR-J3-200□4 or smaller  <p>Insert the connector into CN4.</p> <ul style="list-style-type: none"> ● MR-J3-500□ or larger ● MR-J3-350□4 or larger  <p>Insert the connector into CN4.</p>

Note: MR-J3BAT is a lithium metal battery contains ER6. MR-J3BAT is not subject to the dangerous goods (Class 9) of the UN Recommendations. To transport lithium metal batteries and lithium metal batteries contained in equipment by means of transport subject to the UN Recommendations, take actions to comply with the following regulations: the United Nations Recommendations on the Transport of Dangerous Goods, the Technical Instruction (ICAO-TI) by the International Civil Aviation Organization (ICAO), and the International Maritime Dangerous Goods Code (IMDG Code) by the International Maritime Organization (IMO). To transport the batteries, check the latest standards or the laws of the destination country and take actions. For more information, contact your local safes office. (As of January 2011)

● Battery connection relay cable (MR-J3BTCBL03M)

This relay cable is used to hold the absolute position data if the servo amplifier has to be removed from a machine for shipping. The servo motor does not have a super capacitor (for holding an absolute position data for short time) in the encoder. When this optional cable is used, the absolute position data can be held even when the encoder cable is disconnected from the servo amplifier, making it easy to do maintenance on the servo amplifier.

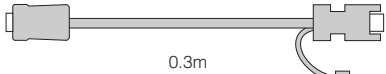
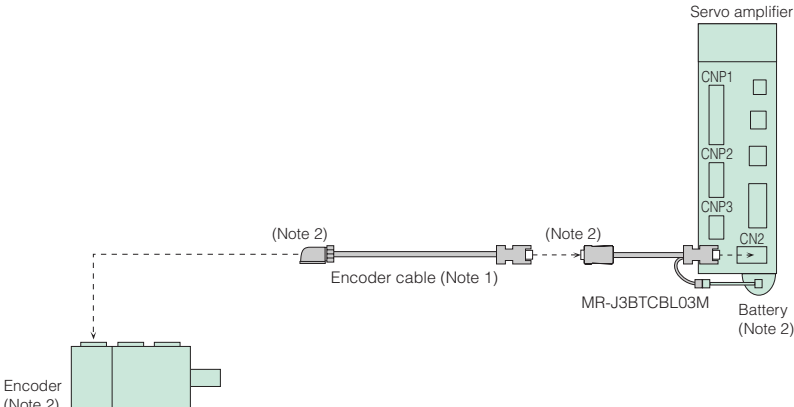
Appearance	Installation method
 <p>0.3m</p>	 <p>Encoder (Note 2)</p> <p>Encoder cable (Note 1)</p> <p>MR-J3BTCBL03M</p> <p>Battery (Note 2)</p> <p>Servo amplifier</p> <p>CNP1</p> <p>CNP2</p> <p>CNP3</p> <p>CN2</p>

Notes: 1. The encoder cable varies depending on the motor series. Refer to "Options ● Cables and connectors (servo motor)" in this catalog.
2. To hold the absolute position data, the encoder, the encoder cable (s), the relay cable and the battery must be kept connected.

User's system		Battery (MR-J3BAT)	Battery connection relay cable (MR-J3BTCBL03M)
Incremental	—	Not required	Not required
Absolute	Not Necessary to hold an absolute position data after the encoder cable is disconnected from the servo amplifier	Required	Not required
	Necessary to hold an absolute position data after the encoder cable is disconnected from the servo amplifier (Note 1)	Required	Required

Notes: 1. Start up the absolute position detection system after connecting this optional cable.

● Diagnostic cable (MR-J3ACHECK) : For MR-J3-□A□ and MR-J3-DU□A(4)

This cable is required when using the amplifier diagnostic function of MR Configurator.

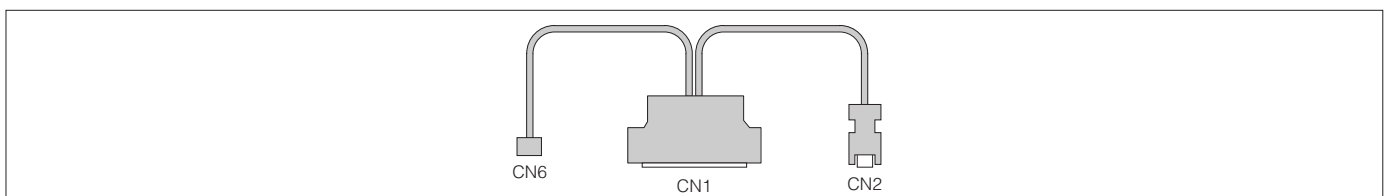

MELSERVO-J3

Options

● Heat sink outside attachment (MR-J3ACN): For MR-J3-11K□(4) to MR-J3-22K□(4)

By mounting the heat sink outside attachment on the servo amplifier, the heat generating section can be mounted outside a cabinet. This makes it possible to dissipate the unit's heat to outside the cabinet. Approximately 50% of the heating value can be dissipated with this method, and the cabinet dimensions can be reduced.



● Manual pulse generator (MR-HDP01): For MR-J3-□T□

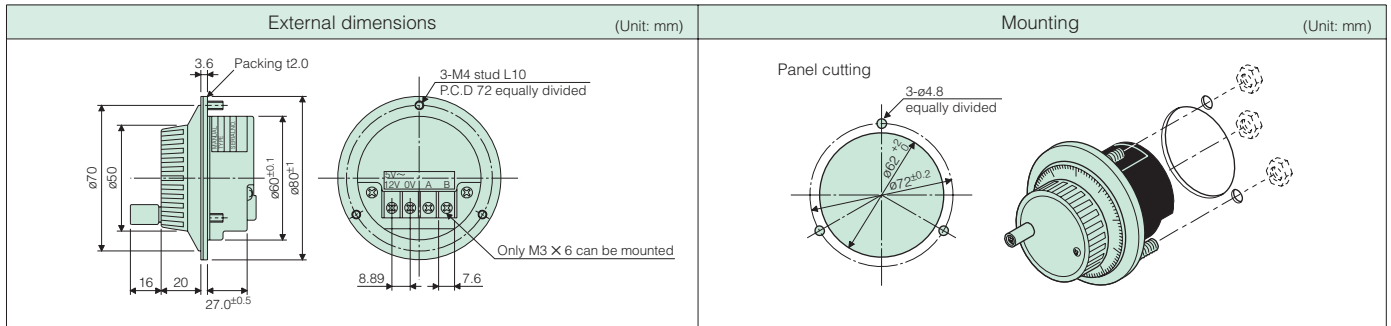

● 6-digit digital switch (MR-DS60): For MR-J3-D01

By using the 6-digit digital switch, position data can be sent to the servo amplifier with BCD signal.

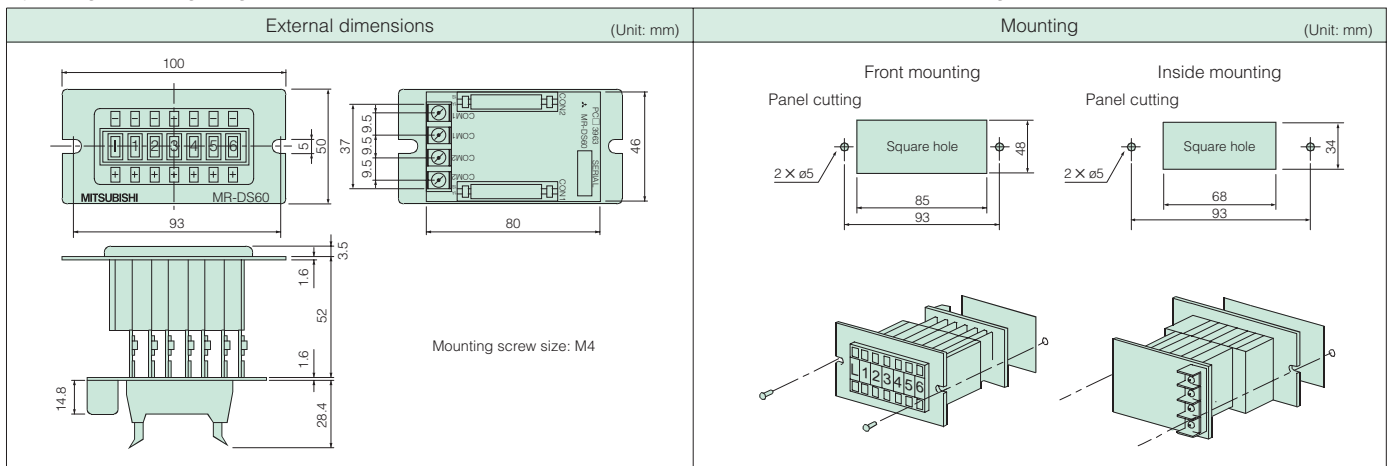

● **Junction terminal block (MR-TB50):** For MR-J3-□A□, MR-J3-DU□A(4) and MR-J3-D01
 All signals can be connected via the junction terminal block.

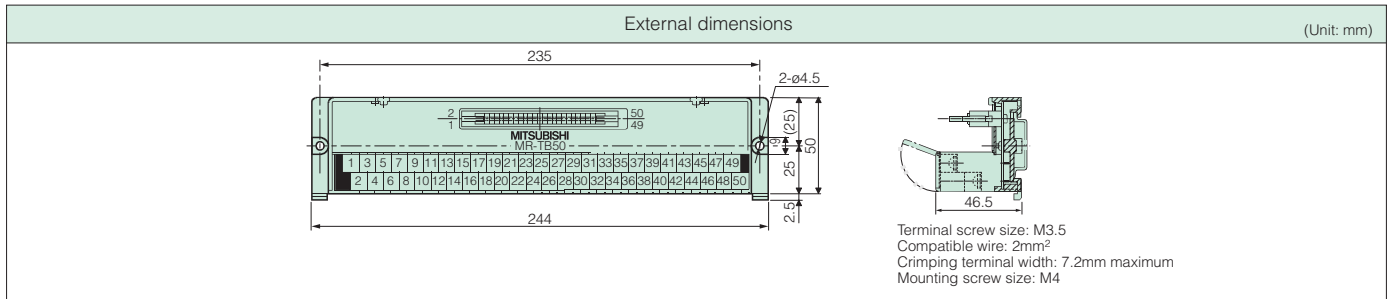

● **Junction terminal block (MR-TB26A):** For MR-J3-□T□
 All signals can be connected via the junction terminal block.

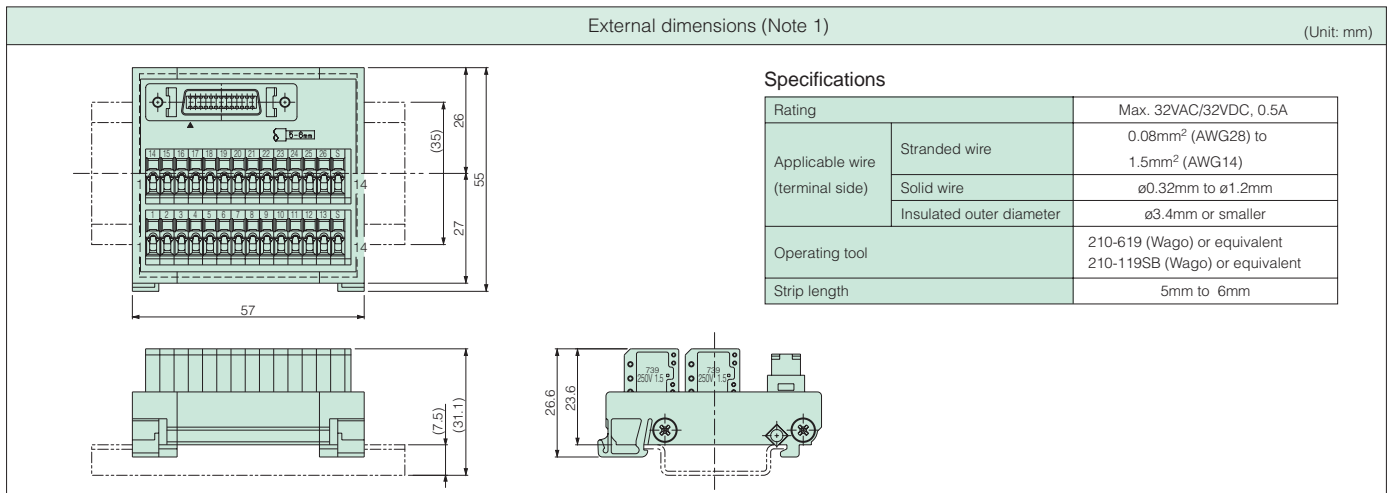

Notes: 1. The lengths in () apply when the junction terminal box is mounted on a 35mm wide DIN rail.

MELSERVO-J3

Options

● Parameter unit (MR-PRU03)

The parameter unit with a 16 characters × 4 lines display, is available as an option.

By connecting the parameter unit to the servo amplifier, data setting, test operation, parameter setting, etc. can be performed without using MR Configurator2 or MR Configurator.

The parameter unit can be used with MR-J3-□A□, MR-J3-DU□A(4) or MR-J3-□T□.

Wiring and communication method

- RS-422 communication
- Connectable with one unit of the servo amplifier with the commercial LAN cable
- Connectable up to 32 axes with multi-drop system

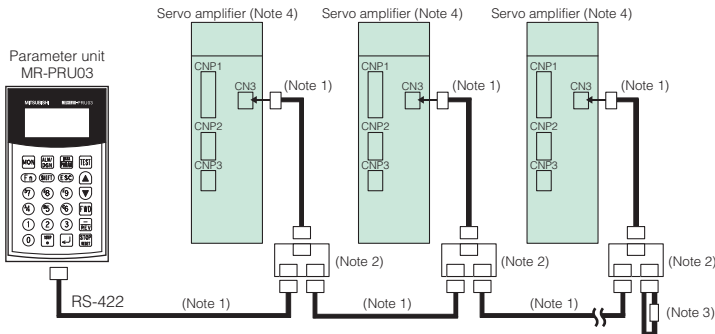

Notes: 1. Use 10BASE-T cable (EIA568 compliant), etc.

Keep the distance between the branch connector and servo amplifier as short as possible.

2. Branch connector, BMJ-8 (HACHIHO ELECTRIC CO., LTD) is recommended. Refer to "Ordering Information for Customers" in this catalog.

3. Connect a 150Ω termination resistor.

4. The parameter unit can be connected to MR-J3-□A□ or MR-J3-□T□ servo amplifier, or MR-J3-DU□A (4) drive unit.

Dimensions

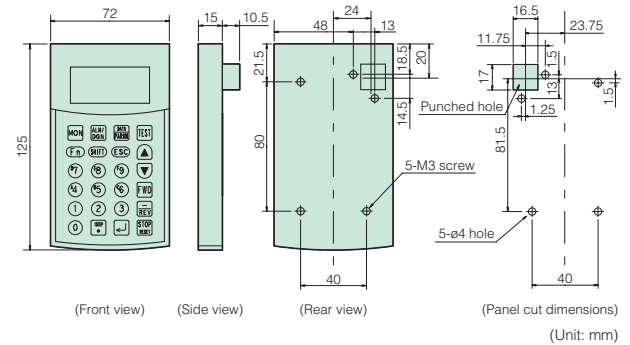

Specifications

Item		Description	
Model		MR-PRU03	
Power supply		Receives power from the servo amplifier or the drive unit	
Functions	Parameter mode	Basic setting parameters, gain/filter parameters, extension setting parameters, input/output setting parameters	
	Monitor mode	MR-J3-□A□ MR-J3-DU□A(4)	Cumulative feedback pulses, droop pulses, cumulative command pulses, command pulse frequency, analog speed command voltage/analog speed limit voltage, analog torque command voltage/analog torque limit voltage, regenerative load ratio, effective load ratio, peak load ratio, instantaneous torque, within one revolution position, ABS counter, servo motor speed, bus voltage, load to motor inertia moment ratio
		MR-J3-□T□	Current position, command position, command remaining distance, point table No., cumulative feedback pulses, droop pulses, regenerative load ratio, effective load ratio, peak load ratio, instantaneous torque, within one revolution position, ABS counter, servo motor speed, bus voltage, load to motor inertia moment ratio
	Diagnosis mode	External input/output display, motor information	
	Alarm mode	Current alarm, alarm history	
	Test operation mode	JOG operation, positioning operation, forced digital output, motor-less operation, single-step feed (Note 1)	
Point table mode (Note 1)	Position data, servo motor speed, acceleration/deceleration time constant, dwell time, auxiliary function, M code		
Display		LCD system (16 characters × 4 lines)	
Environment	Ambient temperature in operation	-10 to 55°C (14 to 131°F) (non freezing)	
	Ambient humidity in operation	90%RH maximum (non condensing)	
	Storage temperature	-20 to 65°C (-4 to 149°F) (non freezing)	
	Storage humidity	90%RH maximum (non condensing)	
	Atmosphere	Indoors (no direct sunlight); no corrosive gas, inflammable gas, oil mist or dust	
Mass (g [lb])		130 (0.29)	

Notes: 1. The point table mode and the single-step feed under the test operation mode are available only when connected to MR-J3-□T□.

Peripheral Equipment

● Electrical wires, circuit breakers and magnetic contactors (example of selection)

The following are examples of wire sizes when 600V polyvinyl chloride insulated wires (IV wires) with a length of 30m are used. Smaller size of wires may be applied by using 600V grade heat-resistant polyvinyl chloride insulated wires (HIV wires).

By considering the wire size, be sure to use HIV wires for HF-JP servo motor series.

Refer to "MR-J3 SERVO AMPLIFIER INSTRUCTION MANUAL" when using HIV wires or when using cables for supplying power (U, V, W) to HF-SP/HF-JP/HC-LP/HC-RP/HC-UP/HA-LP servo motor series.

Servo amplifier 22kW or smaller

Servo amplifier	Circuit breaker	Magnetic contactor (Note 7)	Electrical wire size (mm ²)													
			L1, L2, L3, ⊕ (Note 1)	L11, L21	U, V, W, ⊕	P, C (Note 1)	B1, B2	BU, BV, BW	OHS1, OHS2							
MR-J3-10A(1)/B(1)/T(1)	30A frame 5A	S-N10	2 (AWG14)	1.25 (AWG16)	2 (AWG14)	2 (AWG14)	1.25 (AWG16)	—	—							
MR-J3-20A/B/T																
MR-J3-20A1/B1/T1	30A frame 10A															
MR-J3-40A/B/T																
MR-J3-40A1/B1/T1	30A frame 15A															
MR-J3-60A/B/T																
MR-J3-70A/B/T																
MR-J3-100A/B/T																
MR-J3-200A(N)/B(N)/T(N)	30A frame 20A									S-N18			2 (AWG14)			
MR-J3-350A/B/T	30A frame 30A									S-N20	3.5 (AWG12)		3.5 (AWG12)			
MR-J3-500A/B/T (Note5)	50A frame 50A	S-N35	5.5 (AWG10)		5.5 (AWG10)											
MR-J3-700A/B/T (Note5)	100A frame 75A	S-N50	8 (AWG8)	1.25 (AWG16)	8 (AWG8)	3.5 (AWG12)	1.25 (AWG16) (Note 3)	2 (AWG14) (Note 4)	1.25 (AWG16) (Note 4)							
MR-J3-11KA/B/T (Note5)	100A frame 100A	S-N65	14 (AWG6)		22 (AWG4)	5.5 (AWG10)										
MR-J3-15KA/B/T (Note5)	225A frame 125A	S-N95	22 (AWG4)		30 (AWG2)											
MR-J3-22KA/B/T (Note5)	225A frame 175A	S-N125	50 (AWG1/0)		60 (AWG2/0)											
MR-J3-60A4/B4/T4	30A frame 5A	S-N10	2 (AWG14)		1.25 (AWG16)	2 (AWG14)		2 (AWG14)	—	—						
MR-J3-100A4/B4/T4	30A frame 10A															
MR-J3-200A4/B4/T4	30A frame 15A															
MR-J3-350A4/B4/T4	30A frame 20A	S-N18	5.5 (AWG10)		5.5 (AWG10)	5.5 (AWG10)		5.5 (AWG10)	2 (AWG14)	1.25 (AWG16)						
MR-J3-500A4/B4/T4 (Note5)	30A frame 30A															
MR-J3-700A4/B4/T4 (Note5)	50A frame 40A	S-N20	5.5 (AWG10)		8 (AWG8)	3.5 (AWG12)		3.5 (AWG12)	2 (AWG14) (Note 4)	1.25 (AWG16) (Note 4)						
MR-J3-11KA4/B4/T4 (Note5)	60A frame 60A	S-N25	8 (AWG8)	8 (AWG8)	3.5 (AWG12)	3.5 (AWG12)	2 (AWG14)	1.25 (AWG16)								
MR-J3-15KA4/B4/T4 (Note5)	100A frame 75A	S-N35	14 (AWG6)	22 (AWG4)	5.5 (AWG10)	5.5 (AWG10)	2 (AWG14)	1.25 (AWG16)								
MR-J3-22KA4/B4/T4 (Note5)	225A frame 125A	S-N65														

Drive unit 30kW or larger

Drive unit	Applicable converter unit	Circuit breaker	Magnetic contactor (Note 7)	Electrical wire size (mm ²)					
				L1, L2, L3, ⊕	L11, L21	U, V, W, ⊕	P2, C (Note 1)	BU, BV, BW	OHS1, OHS2
MR-J3-DU30KA/B (Note5)	MR-J3-CR55K	400A frame 250A	S-N150	50 (AWG1/0)	2 (AWG14)	60 (AWG2/0)	5.5 (AWG10)	2 (AWG14)	1.25 (AWG16)
MR-J3-DU37KA/B (Note5)		400A frame 300A	S-N180	60 (AWG2/0)		60 (AWG2/0) (Note 6)			
MR-J3-DU30KA4/B4 (Note5)	MR-J3-CR55K4	225A frame 125A	S-N95	22 (AWG4)	2 (AWG14)	30 (AWG2)	5.5 (AWG10)	1.25 (AWG16)	1.25 (AWG16)
MR-J3-DU37KA4/B4 (Note5)		225A frame 150A	S-N125	30 (AWG2)		38 (AWG2)			
MR-J3-DU45KA4/B4 (Note5)		225A frame 175A	S-N150	38 (AWG2)		50 (AWG1/0)			
MR-J3-DU55KA4/B4 (Note5)		400A frame 225A	S-N180	50 (AWG1/0)		60 (AWG2/0)			

- Notes: 1. Connect a reactor or an optional regeneration unit using the 5m or shorter length electrical wire. For the electrical wire size suitable for the power factor improvement DC reactor, refer to "Peripheral Equipment ● Power factor improvement DC reactor" in this catalog.
2. Use a fluorine resin wire (0.75mm² (AWG19)) when connecting to motor power supply connector. Refer to "SERVO AMPLIFIER INSTRUCTION MANUAL" for details on wiring cables.
3. Use a fluorine resin wire (0.5mm² (AWG20)) when connecting to motor electromagnetic brake connector. Refer to "SERVO AMPLIFIER INSTRUCTION MANUAL" for details on wiring cables.
4. The electrical wire size is for the servo motor with a cooling fan.
5. When connecting the wires to the terminal screws, be sure to use the screws attached to the terminal blocks.
6. This wire size applies when HIV wire (600V grade heat-resistant polyvinyl chloride insulated wire) with a length of 30m is used.
7. Be sure to use a magnetic contactor (MC) with an operation delay time of 80ms or less. The operation delay time is the time interval between current being applied to the coil until closure of contacts.

Peripheral Equipment

● Radio noise filter (FR-BIF, FR-BIF-H)

This filter effectively controls noise emitted from the power supply side of the servo amplifier or the converter unit and is especially effective for radio frequency bands 10MHz or lower. The FR-BIF is designed for the input only.

External dimensions (Unit: mm)	Connections
<p>Leakage current: 4mA</p>	<p>This filter is not connectable to output side of the servo amplifier or the converter unit. Wiring should be as short as possible. Grounding is always required. Be sure to insulate the unused wire when using FR-BIF with 1-phase power.</p> <p>For MR-J3-350□ or smaller, MR-J3-200□4 or smaller and MR-J3W□B</p> <p>For MR-J3-500□ or larger and MR-J3-350□4 or larger</p> <p>100VAC/200VAC class : FR-BIF 400VAC class : FR-BIF-H</p>

● Line noise filter (FR-BSF01, FR-BLF)

This filter is effective in suppressing radio noise emitted from the power supply side or the output side of the servo amplifier or the converter unit, and also in suppressing high-frequency leakage current (zero-phase current), especially within 0.5MHz to 5MHz band.

External dimensions (Unit: mm)	Connections
<p>FR-BSF01 For electrical wire size of 3.5mm² (AWG12) or smaller</p> <p>FR-BLF For electrical wire size of 5.5mm² (AWG10) or larger</p>	<p>Use the line noise filter for wires of the main power supply (L1, L2, L3) of the servo amplifier or the converter unit, and of the motor power supply (U, V, W). Pass each of the wires through the line noise filter equal times in a same direction. For the main power supply, the effect of the filter rises as the number of passes increases, but generally four passes would be appropriate. For the motor power supply, passes must be four times or less. Do not pass the grounding (earth) wire through the filter, or the effect of the filter will drop. Wind the wires to pass through the filter as the required number of passes as shown in Fig.1. If the wires are too thick to wind, use two or more filters to have the required number of passes as shown in Fig.2. Place the line noise filters as close to the servo amplifier or the converter unit as possible for their best performance.</p>

● Data line filter

Noise can be prevented by attaching a data line filter to the pulse output cable of the pulse train output controller or the motor encoder cable.

Example

Data line filter: ESD-SR-250 (manufactured by NEC TOKIN Corporation) or ZCAT3035-1330 (manufactured by TDK Corporation)

● Surge killer

Attach surge killers to AC relays and AC valves around the servo amplifier or the drive unit and the converter unit. Attach diodes to DC relays and DC valves.

Example

Surge killer : CR-50500 (manufactured by Okaya Electric Industries Co., Ltd.)

Diode : A diode with breakdown voltage 4 or more times greater than the relay's drive voltage, and with current capacity 2 or more times greater than the relay's drive current.

MELSERVO-J3

Peripheral Equipment

● EMC filter

	External dimensions (Unit: mm)	Connections										
D	<p>● TF3200A-UN</p> <table border="1"> <thead> <tr> <th>Model</th> <th>Leakage current (mA)</th> <th>Mass kg (lb)</th> </tr> </thead> <tbody> <tr> <td>TF3200A-UN</td> <td>9.0</td> <td>18 (40)</td> </tr> </tbody> </table>	Model	Leakage current (mA)	Mass kg (lb)	TF3200A-UN	9.0	18 (40)					
Model	Leakage current (mA)	Mass kg (lb)										
TF3200A-UN	9.0	18 (40)										
E	<p>● TF3005C-TX, TF3020C-TX, TF3030C-TX</p> <table border="1"> <thead> <tr> <th>Model</th> <th>Leakage current (mA)</th> <th>Mass kg (lb)</th> </tr> </thead> <tbody> <tr> <td>TF3005C-TX</td> <td rowspan="3">5.5</td> <td>6.0 (13)</td> </tr> <tr> <td>TF3020C-TX</td> <td>7.5 (17)</td> </tr> <tr> <td>TF3030C-TX</td> <td></td> </tr> </tbody> </table>	Model	Leakage current (mA)	Mass kg (lb)	TF3005C-TX	5.5	6.0 (13)	TF3020C-TX	7.5 (17)	TF3030C-TX		
Model	Leakage current (mA)	Mass kg (lb)										
TF3005C-TX	5.5	6.0 (13)										
TF3020C-TX		7.5 (17)										
TF3030C-TX												
F	<p>● TF3040C-TX, TF3060C-TX</p> <table border="1"> <thead> <tr> <th>Model</th> <th>Leakage current (mA)</th> <th>Mass kg (lb)</th> </tr> </thead> <tbody> <tr> <td>TF3040C-TX</td> <td rowspan="2">5.5</td> <td rowspan="2">12.5 (28)</td> </tr> <tr> <td>TF3060C-TX</td> </tr> </tbody> </table>	Model	Leakage current (mA)	Mass kg (lb)	TF3040C-TX	5.5	12.5 (28)	TF3060C-TX				
Model	Leakage current (mA)	Mass kg (lb)										
TF3040C-TX	5.5	12.5 (28)										
TF3060C-TX												
G	<p>● TF3150C-TX</p> <table border="1"> <thead> <tr> <th>Model</th> <th>Leakage current (mA)</th> <th>Mass kg (lb)</th> </tr> </thead> <tbody> <tr> <td>TF3150C-TX</td> <td>5.5</td> <td>31 (68)</td> </tr> </tbody> </table>	Model	Leakage current (mA)	Mass kg (lb)	TF3150C-TX	5.5	31 (68)					
Model	Leakage current (mA)	Mass kg (lb)										
TF3150C-TX	5.5	31 (68)										

● Power factor improvement DC reactor (FR-BEL)

This reactor enables users to boost the servo amplifier's power factor and reduce its power supply capacity. Use either the DC reactor or the AC reactor. However, as compared to the AC reactor, the DC reactor is more recommended since the DC reactor is more effective in power factor improvement, smaller and lighter, and its wiring is easier. (The DC reactor uses 2 wires, while the AC reactor uses 6 wires.)

Model	Applicable servo amplifier	Fig.
FR-BEL-0.4K	MR-J3-10A/B/T MR-J3-20A/B/T	A
FR-BEL-0.75K	MR-J3-40A/B/T	
FR-BEL-1.5K	MR-J3-60A/B/T MR-J3-70A/B/T	
FR-BEL-2.2K	MR-J3-100A/B/T	
FR-BEL-3.7K	MR-J3-200A(N)/B(N)/T(N)	
FR-BEL-7.5K	MR-J3-350A/B/T	
FR-BEL-11K	MR-J3-500A/B/T	
FR-BEL-H1.5K	MR-J3-60A4/B4/T4	
FR-BEL-H2.2K	MR-J3-100A4/B4/T4	
FR-BEL-H3.7K	MR-J3-200A4/B4/T4	
FR-BEL-H7.5K	MR-J3-350A4/B4/T4	
FR-BEL-H11K	MR-J3-500A4/B4/T4	

Model	Applicable servo amplifier or drive unit	Applicable converter unit	Fig.
FR-BEL-15K	MR-J3-700A/B/T MR-J3-11KA/B/T	—	B
FR-BEL-22K	MR-J3-15KA/B/T	—	
FR-BEL-30K	MR-J3-22KA/B/T	—	
FR-BEL-H15K	MR-J3-700A4/B4/T4 MR-J3-11KA4/B4/T4	—	
FR-BEL-H22K	MR-J3-15KA4/B4/T4	—	
FR-BEL-H30K	MR-J3-22KA4/B4/T4	—	C
MR-DCL30K	MR-J3-DU30KA/B	MR-J3-CR55K	
MR-DCL37K	MR-J3-DU37KA/B	—	
MR-DCL30K-4	MR-J3-DU30KA4/B4	—	
MR-DCL37K-4	MR-J3-DU37KA4/B4	—	
MR-DCL45K-4	MR-J3-DU45KA4/B4	MR-J3-CR55K4	
MR-DCL55K-4	MR-J3-DU55KA4/B4	—	

External dimensions		(Unit: mm)		Connections									
	Model	Variable dimensions						Mounting screw size	Mass kg (lb)	Wire size (mm ²)			
	FR-BEL-0.4K	110	50	94	1.6	95	6 X 12	M3.5	25	M5		0.5 (1.1)	2 (AWG14)
	FR-BEL-0.75K	120	53	102	1.6	105	6 X 12	M4	25	M5		0.7 (1.5)	
	FR-BEL-1.5K	130	65	110	1.6	115	6 X 12	M4	30	M5		1.1 (2.4)	
	FR-BEL-2.2K	130	65	110	1.6	115	6 X 12	M4	30	M5		1.2 (2.6)	
	FR-BEL-3.7K	150	75	102	2.0	135	6 X 12	M4	40	M5		1.7 (3.7)	
	FR-BEL-7.5K	150	75	126	2.0	135	6 X 12	M5	40	M5		2.3 (5.1)	3.5 (AWG12)
	FR-BEL-11K	170	93	132	2.3	155	6 X 14	M5	50	M5		3.1 (6.8)	
	FR-BEL-H1.5K	130	63	89	1.6	115	6 X 12	M3.5	32	M5		0.9 (2.0)	5.5 (AWG10)
	FR-BEL-H2.2K	130	63	101	1.6	115	6 X 12	M3.5	32	M5		1.1 (2.4)	
	FR-BEL-H3.7K	150	75	102	2.0	135	6 X 12	M4	40	M5		1.7 (3.7)	
FR-BEL-H7.5K	150	75	124	2.0	135	6 X 12	M4	40	M5	2.3 (5.1)			
FR-BEL-H11K	170	93	132	2.3	155	6 X 14	M5	50	M5	3.1 (6.8)			
	Model	Variable dimensions						Mounting screw size	Mass kg (lb)	Wire size (mm ²)			
	FR-BEL-15K	170	93	170	2.3	155	6 X 14	M8	56	M6		3.8 (8.4)	8 (AWG8) 22 (AWG4) (Note 1)
	FR-BEL-22K	185	119	182	2.6	165	7 X 15	M8	70	M6		5.4 (12)	30 (AWG2)
	FR-BEL-30K	185	119	201	2.6	165	7 X 15	M8	70	M6		6.7 (15)	60 (AWG2/0)
	FR-BEL-H15K	170	93	160	2.3	155	6 X 14	M6	56	M5		3.7 (8.2)	8 (AWG8)
	FR-BEL-H22K	185	119	171	2.6	165	7 X 15	M6	70	M6		5.0 (11)	22 (AWG4)
	FR-BEL-H30K	185	119	189	2.6	165	7 X 15	M6	70	M6		6.7 (15)	22 (AWG4)
	Model	Variable dimensions				Terminal screw size	Mass kg (lb)	Wire size (mm ²)					
	MR-DCL30K	255	135	80	215	232	M12	9.5 (21)		60 (AWG2/0)			
	MR-DCL37K	255	135	80	215	232	M12	9.5 (21)		80 (AWG3/0)			
	MR-DCL30K-4	205	135	75	200	175	M8	6.5 (14)		30 (AWG2)			
	MR-DCL37K-4	225	135	80	200	197	M8	7 (15)		38 (AWG2)			
	MR-DCL45K-4	240	135	80	200	212	M8	7.5 (17)		50 (AWG1/0)			
	MR-DCL55K-4	260	135	80	215	232	M8	9.5 (21)		60 (AWG2/0)			

- Notes: 1. When using FR-BEL15K, select a wire size 8mm² (AWG8) for MR-J3-700A/B/T; and 22mm² (AWG4) for MR-J3-11KA/B/T.
 2. The terminal cover is supplied with the unit. Install the cover after connecting the wires.
 3. When using the DC reactor, disconnect the short bar between P1 and P2.
 4. When using the DC reactor, disconnect the short bar between P and P1.

MELSERVO-J3

Peripheral Equipment

● Power factor improvement AC reactor (FR-BAL)

This reactor enables users to boost the servo amplifier's power factor and reduce its power supply capacity. Use either the DC reactor or the AC reactor.

Model	Applicable servo amplifier
FR-BAL-0.4K	MR-J3-10A/B/T, MR-J3-10A1/B1/T1 MR-J3-20A/B/T
FR-BAL-0.75K	MR-J3-20A1/B1/T1 MR-J3-40A/B/T
FR-BAL-1.5K	MR-J3-40A1/B1/T1 MR-J3-60A/B/T MR-J3-70A/B/T
FR-BAL-2.2K	MR-J3-100A/B/T
FR-BAL-3.7K	MR-J3-200A(N)/B(N)/T(N)
FR-BAL-7.5K	MR-J3-350A/B/T
FR-BAL-11K	MR-J3-500A/B/T
FR-BAL-15K	MR-J3-700A/B/T MR-J3-11KA/B/T
FR-BAL-22K	MR-J3-15KA/B/T
FR-BAL-30K	MR-J3-22KA/B/T

Model	Applicable servo amplifier
FR-BAL-H1.5K	MR-J3-60A4/B4/T4
FR-BAL-H2.2K	MR-J3-100A4/B4/T4
FR-BAL-H3.7K	MR-J3-200A4/B4/T4
FR-BAL-H7.5K	MR-J3-350A4/B4/T4
FR-BAL-H11K	MR-J3-500A4/B4/T4
FR-BAL-H15K	MR-J3-700A4/B4/T4 MR-J3-11KA4/B4/T4
FR-BAL-H22K	MR-J3-15KA4/B4/T4
FR-BAL-H30K	MR-J3-22KA4/B4/T4

External dimensions		(Unit: mm)		Connections																																																																																																																																																																																																			
		<table border="1"> <thead> <tr> <th rowspan="2">Model</th> <th colspan="5">Variable dimensions</th> <th rowspan="2">Mounting screw size</th> <th rowspan="2">Terminal screw size</th> <th rowspan="2">Mass kg (lb)</th> </tr> <tr> <th>W</th> <th>W1</th> <th>H</th> <th>D</th> <th>D1</th> </tr> </thead> <tbody> <tr><td>FR-BAL-0.4K</td><td>135</td><td>120</td><td>115</td><td>59</td><td>45⁰_{-2.5}</td><td>7.5</td><td>M4</td><td>M3.5</td><td>2.0 (4.4)</td></tr> <tr><td>FR-BAL-0.75K</td><td>135</td><td>120</td><td>115</td><td>69</td><td>57⁰_{-2.5}</td><td>7.5</td><td>M4</td><td>M3.5</td><td>2.8 (6.2)</td></tr> <tr><td>FR-BAL-1.5K</td><td>160</td><td>145</td><td>140</td><td>71</td><td>55⁰_{-2.5}</td><td>7.5</td><td>M4</td><td>M3.5</td><td>3.7 (8.2)</td></tr> <tr><td>FR-BAL-2.2K</td><td>160</td><td>145</td><td>140</td><td>91</td><td>75⁰_{-2.5}</td><td>7.5</td><td>M4</td><td>M3.5</td><td>5.6 (12)</td></tr> <tr><td>FR-BAL-3.7K</td><td>220</td><td>200</td><td>192</td><td>90</td><td>70⁰_{-2.5}</td><td>10</td><td>M5</td><td>M4</td><td>8.5 (19)</td></tr> <tr><td>FR-BAL-7.5K</td><td>220</td><td>200</td><td>194</td><td>120</td><td>100⁰_{-2.5}</td><td>10</td><td>M5</td><td>M5</td><td>14.5 (32)</td></tr> <tr><td>FR-BAL-11K</td><td>280</td><td>255</td><td>220</td><td>135</td><td>100⁰_{-2.5}</td><td>12.5</td><td>M6</td><td>M6</td><td>19 (42)</td></tr> <tr><td>FR-BAL-15K</td><td>295</td><td>270</td><td>275</td><td>133</td><td>110⁰_{-2.5}</td><td>12.5</td><td>M6</td><td>M6</td><td>27 (60)</td></tr> <tr><td>FR-BAL-22K</td><td>290</td><td>240</td><td>301</td><td>199</td><td>170±5</td><td>25</td><td>M8</td><td>M8</td><td>35 (77)</td></tr> <tr><td>FR-BAL-30K</td><td>290</td><td>240</td><td>301</td><td>219</td><td>190±5</td><td>25</td><td>M8</td><td>M8</td><td>43 (95)</td></tr> <tr><td>FR-BAL-H1.5K</td><td>160</td><td>145</td><td>140</td><td>87</td><td>70⁰_{-2.5}</td><td>7.5</td><td>M4</td><td>M3.5</td><td>5.3 (12)</td></tr> <tr><td>FR-BAL-H2.2K</td><td>160</td><td>145</td><td>140</td><td>91</td><td>75⁰_{-2.5}</td><td>7.5</td><td>M4</td><td>M3.5</td><td>5.9 (13)</td></tr> <tr><td>FR-BAL-H3.7K</td><td>220</td><td>200</td><td>190</td><td>90</td><td>70⁰_{-2.5}</td><td>10</td><td>M5</td><td>M3.5</td><td>8.5 (19)</td></tr> <tr><td>FR-BAL-H7.5K</td><td>220</td><td>200</td><td>192</td><td>120</td><td>100±5</td><td>10</td><td>M5</td><td>M4</td><td>14 (31)</td></tr> <tr><td>FR-BAL-H11K</td><td>280</td><td>255</td><td>226</td><td>130</td><td>100±5</td><td>12.5</td><td>M6</td><td>M5</td><td>18.5 (41)</td></tr> <tr><td>FR-BAL-H15K</td><td>295</td><td>270</td><td>244</td><td>130</td><td>110±5</td><td>12.5</td><td>M6</td><td>M5</td><td>27 (60)</td></tr> <tr><td>FR-BAL-H22K</td><td>290</td><td>240</td><td>269</td><td>199</td><td>170±5</td><td>25</td><td>M8</td><td>M8</td><td>35 (77)</td></tr> <tr><td>FR-BAL-H30K</td><td>290</td><td>240</td><td>290</td><td>219</td><td>190±5</td><td>25</td><td>M8</td><td>M8</td><td>43 (95)</td></tr> </tbody> </table>		Model	Variable dimensions					Mounting screw size	Terminal screw size	Mass kg (lb)	W	W1	H	D	D1	FR-BAL-0.4K	135	120	115	59	45 ⁰ _{-2.5}	7.5	M4	M3.5	2.0 (4.4)	FR-BAL-0.75K	135	120	115	69	57 ⁰ _{-2.5}	7.5	M4	M3.5	2.8 (6.2)	FR-BAL-1.5K	160	145	140	71	55 ⁰ _{-2.5}	7.5	M4	M3.5	3.7 (8.2)	FR-BAL-2.2K	160	145	140	91	75 ⁰ _{-2.5}	7.5	M4	M3.5	5.6 (12)	FR-BAL-3.7K	220	200	192	90	70 ⁰ _{-2.5}	10	M5	M4	8.5 (19)	FR-BAL-7.5K	220	200	194	120	100 ⁰ _{-2.5}	10	M5	M5	14.5 (32)	FR-BAL-11K	280	255	220	135	100 ⁰ _{-2.5}	12.5	M6	M6	19 (42)	FR-BAL-15K	295	270	275	133	110 ⁰ _{-2.5}	12.5	M6	M6	27 (60)	FR-BAL-22K	290	240	301	199	170±5	25	M8	M8	35 (77)	FR-BAL-30K	290	240	301	219	190±5	25	M8	M8	43 (95)	FR-BAL-H1.5K	160	145	140	87	70 ⁰ _{-2.5}	7.5	M4	M3.5	5.3 (12)	FR-BAL-H2.2K	160	145	140	91	75 ⁰ _{-2.5}	7.5	M4	M3.5	5.9 (13)	FR-BAL-H3.7K	220	200	190	90	70 ⁰ _{-2.5}	10	M5	M3.5	8.5 (19)	FR-BAL-H7.5K	220	200	192	120	100±5	10	M5	M4	14 (31)	FR-BAL-H11K	280	255	226	130	100±5	12.5	M6	M5	18.5 (41)	FR-BAL-H15K	295	270	244	130	110±5	12.5	M6	M5	27 (60)	FR-BAL-H22K	290	240	269	199	170±5	25	M8	M8	35 (77)	FR-BAL-H30K	290	240	290	219	190±5	25	M8	M8	43 (95)		
Model	Variable dimensions					Mounting screw size	Terminal screw size	Mass kg (lb)																																																																																																																																																																																															
	W	W1	H	D	D1																																																																																																																																																																																																		
FR-BAL-0.4K	135	120	115	59	45 ⁰ _{-2.5}	7.5	M4	M3.5	2.0 (4.4)																																																																																																																																																																																														
FR-BAL-0.75K	135	120	115	69	57 ⁰ _{-2.5}	7.5	M4	M3.5	2.8 (6.2)																																																																																																																																																																																														
FR-BAL-1.5K	160	145	140	71	55 ⁰ _{-2.5}	7.5	M4	M3.5	3.7 (8.2)																																																																																																																																																																																														
FR-BAL-2.2K	160	145	140	91	75 ⁰ _{-2.5}	7.5	M4	M3.5	5.6 (12)																																																																																																																																																																																														
FR-BAL-3.7K	220	200	192	90	70 ⁰ _{-2.5}	10	M5	M4	8.5 (19)																																																																																																																																																																																														
FR-BAL-7.5K	220	200	194	120	100 ⁰ _{-2.5}	10	M5	M5	14.5 (32)																																																																																																																																																																																														
FR-BAL-11K	280	255	220	135	100 ⁰ _{-2.5}	12.5	M6	M6	19 (42)																																																																																																																																																																																														
FR-BAL-15K	295	270	275	133	110 ⁰ _{-2.5}	12.5	M6	M6	27 (60)																																																																																																																																																																																														
FR-BAL-22K	290	240	301	199	170±5	25	M8	M8	35 (77)																																																																																																																																																																																														
FR-BAL-30K	290	240	301	219	190±5	25	M8	M8	43 (95)																																																																																																																																																																																														
FR-BAL-H1.5K	160	145	140	87	70 ⁰ _{-2.5}	7.5	M4	M3.5	5.3 (12)																																																																																																																																																																																														
FR-BAL-H2.2K	160	145	140	91	75 ⁰ _{-2.5}	7.5	M4	M3.5	5.9 (13)																																																																																																																																																																																														
FR-BAL-H3.7K	220	200	190	90	70 ⁰ _{-2.5}	10	M5	M3.5	8.5 (19)																																																																																																																																																																																														
FR-BAL-H7.5K	220	200	192	120	100±5	10	M5	M4	14 (31)																																																																																																																																																																																														
FR-BAL-H11K	280	255	226	130	100±5	12.5	M6	M5	18.5 (41)																																																																																																																																																																																														
FR-BAL-H15K	295	270	244	130	110±5	12.5	M6	M5	27 (60)																																																																																																																																																																																														
FR-BAL-H22K	290	240	269	199	170±5	25	M8	M8	35 (77)																																																																																																																																																																																														
FR-BAL-H30K	290	240	290	219	190±5	25	M8	M8	43 (95)																																																																																																																																																																																														

Notes: 1. When using a power supply, 1-phase 200VAC to 230VAC, connect the power supply to the L1 and L2 terminals. Do not connect anything to L3. 1-phase 200VAC to 230VAC is available only for the MR-J3-70□ or smaller servo amplifier.

MR-J3-BSafety: Connections with Peripheral Equipment (Note 1)

Peripheral equipment is connected to MR-J3-□S as described below.

Connectors, cables, options, and other necessary equipment are available so that users can set up MR-J3-□S easily and start using it right away. Due to the SSCNET III-compatible simple connections, the MR-J3-□S reduces wiring and prevents wiring errors.

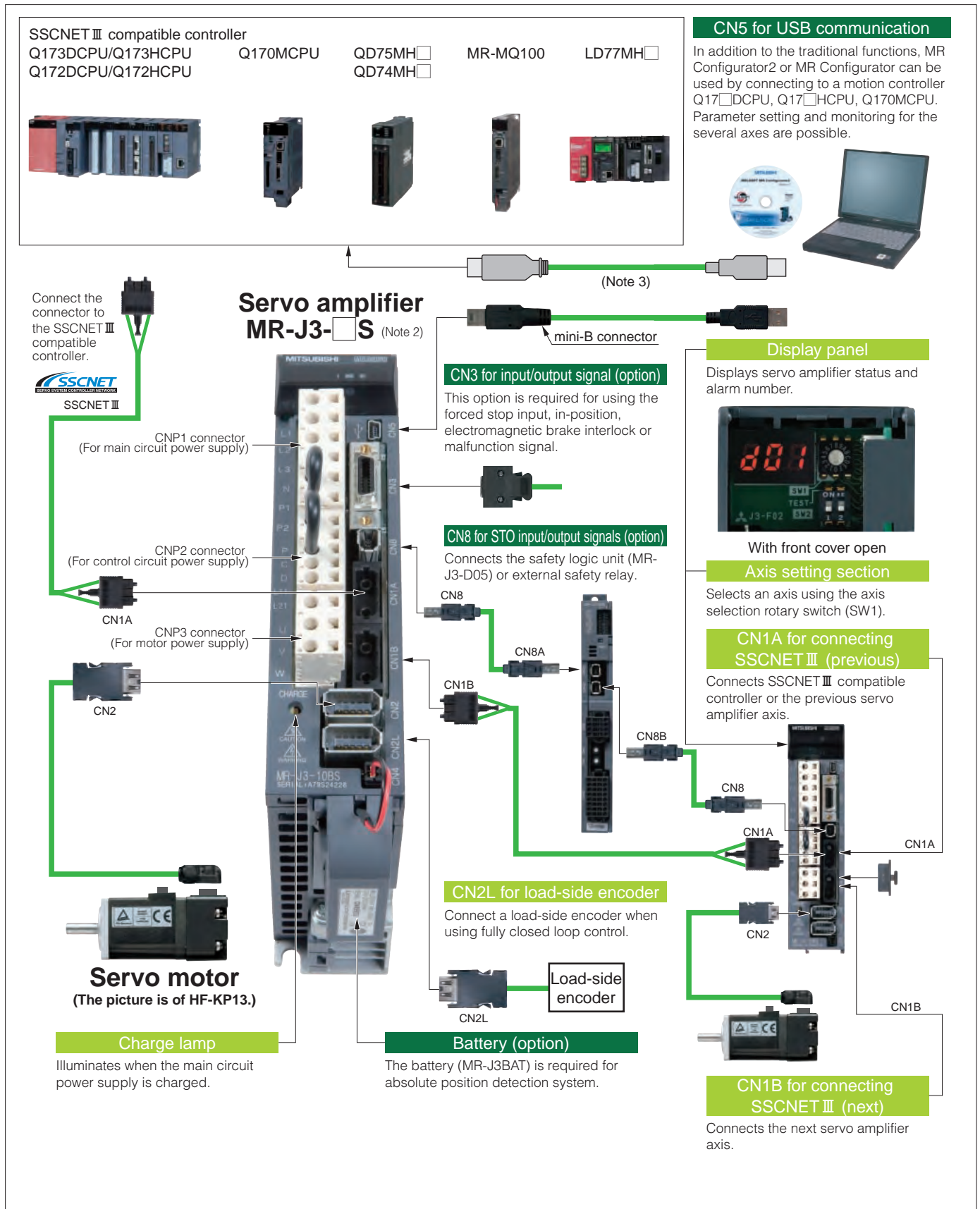

Notes: 1. Refer to "MR-J3-□B Safety SERVO AMPLIFIER INSTRUCTION MANUAL" for the actual connections.
2. The connections with the peripheral equipment shown above is for MR-J3-350□S or smaller servo amplifier.
3. Cable for connecting a controller and a personal computer must be prepared by the user. Refer to relevant User's Manual for details.

MELSERVO-J3

MR-J3-BSafety features

- Safety functions of the MR-J3-BSafety and MR-J3-D05 are certified for IEC/EN 61508 SIL 2, EN 62061 SIL CL 2 and EN ISO 13849-1 PL d (Category 3) by a certification body (TÜV Rheinland). As a safety function, MR-J3-BSafety has an integrated Safe torque off (STO) function. Safe stop 1 (SS1) function can be realized by combining MR-J3-BSafety with MR-J3-D05. These functions contribute to improvement of safety in the user's system, making it easy to be certified by a certification body.

Realizing safety circuit

- User's system can satisfy stop category 0 by using the Safe torque off (STO) function.
- User's system can satisfy stop category 0 and 1 by using the Safe torque off (STO) and Safe stop 1 (SS1) functions.

Compatibility with MR-J3-B

- Mounting, wiring and connectors of MR-J3-BSafety are compatible with those of MR-J3-B. Thus, MR-J3-B can be easily replaced by the MR-J3-BSafety while still using the existing connections. The safety functions are accessible by connecting an external safety circuit to the new CN8 connector added for drive safety on the MR-J3-BSafety.

Compatible with fully closed loop control system

- The MR-J3-BSafety lineup contains fully closed loop control system versions.

* Refer to EN IEC 61800-5-2 for details of Safe torque off (STO) and Safe stop 1 (SS1) functions.

* Refer to EN IEC 60204-1 for details of stop category.



System configurations

Example of using 2 systems of STO and SS1 functions (Note 5)

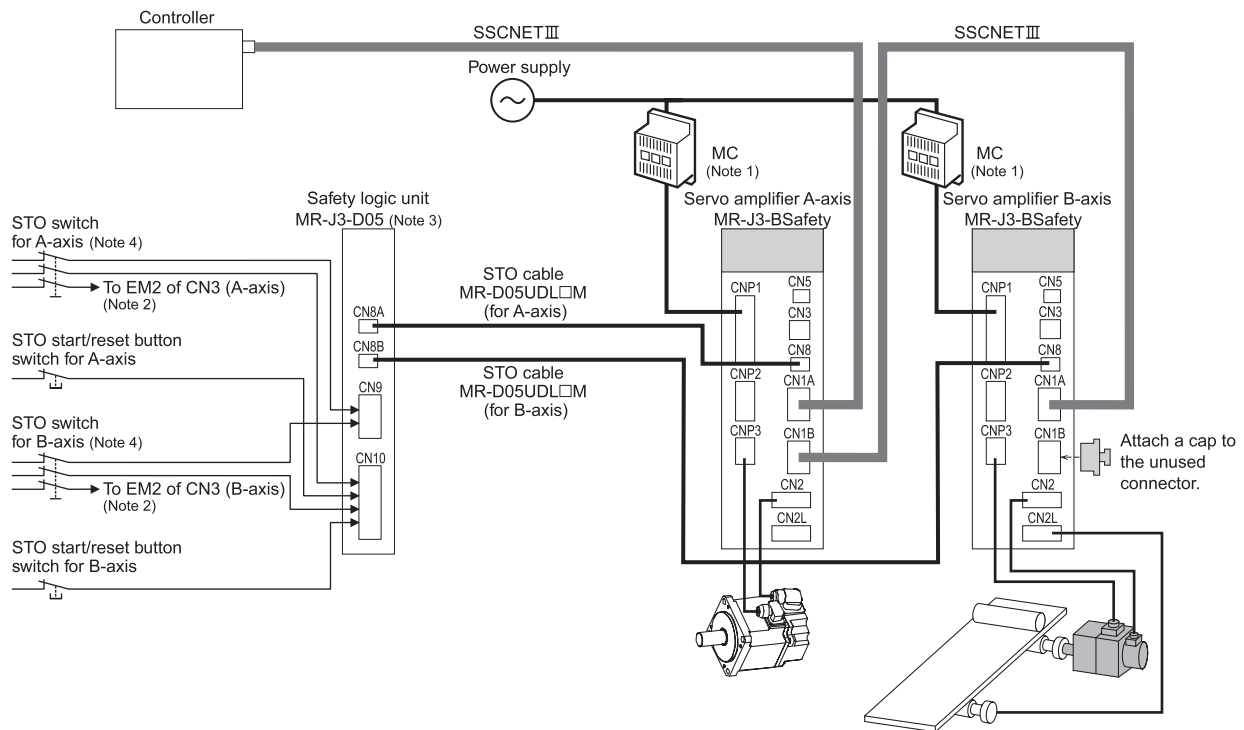

- Notes:
1. For prevention of electric shock during maintenance or for protection during servo amplifier fault, be sure to connect a magnetic contactor (MC) between the main power supply and L1, L2 and L3 of the servo amplifier or the converter unit.
 2. Connect the STO switch signal and the forced stop 2 (EM2) signal in connector CN3 of the servo amplifier in addition to the connection with the safety logic unit (MR-J3-D05).
 3. Safety logic unit (MR-J3-D05) has 2 independent systems (A-axis and B-axis).
 4. All safety-related components such as relays, sensors, etc., must meet the applicable safety standards.
 5. Perform risk assessment and safety level certification on the entire machine/system.

For Servo Amplifier Model Designation

MR-J3- S

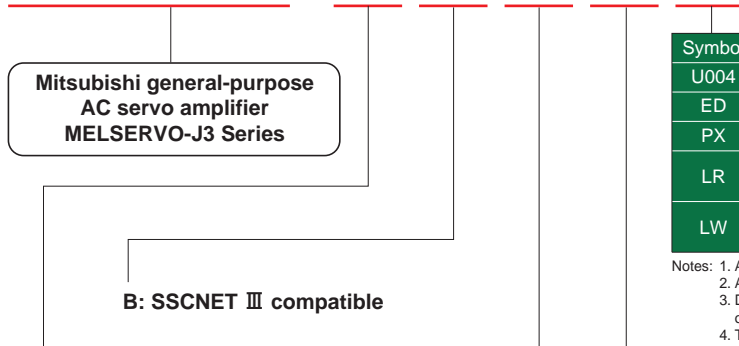

Symbol	Rated output (kW)
10	0.1
20	0.2
40	0.4
60	0.6
70	0.75
100	1
200	2
350	3.5
500	5
700	7
11K	11
15K	15
22K	22

Drive Safety integrated

Symbol	Special specifications
U004	1-phase 200 to 240VAC (Note 1)
ED	Without a dynamic brake (Note 2)
PX	Without an enclosed regenerative resistor (Note 3)
LR	Dedicated servo amplifier for HF-JP servo motor of 11kW and 15kW, with an enclosed regenerative resistor
LW	Dedicated servo amplifier for HF-JP servo motor of 11kW and 15kW, without an enclosed regenerative resistor (Note 4)

Notes: 1. Available in 750W or smaller servo amplifier.
 2. Available in 11kW to 22kW servo amplifier. A regenerative resistor (standard accessory) is not enclosed.
 3. Dynamic brake does not work at alarm occurrence or power failure. Take measures to ensure safety on the entire system.
 4. This servo amplifier is required when using HF-JP servo motor of 11kW and 15kW. Regenerative resistor is not included.

Symbol	Power supply
None	3-phase 200VAC or 1-phase 200VAC (Note 1)
1	1-phase 100VAC (Note 2)
4	3-phase 400VAC (Note 3)

Notes: 1. MR-J3-10□S, -20□S, -40□S, -60□S and -70□S are available for 1-phase 200VAC.
 2. MR-J3-10□1, -20□1 and -40□1 are available.
 3. MR-J3-60□S4, -100□S4, -200□S4, -350□S4, -500□S4, -700□S4, -11K□S4, -15K□S4 and -22K□S4 are available.

List of compatible servo motors

Symbol	200V class								400V class				
	HF-KP	HF-MP	HF-SP	HF-JP		HC-LP	HC-RP	HC-UP	HA-LP	HF-SP	HF-JP		HA-LP
10	053, 13	053, 13	—	—	—	—	—	—	—	—	—	—	—
20	23	23	—	—	—	—	—	—	—	—	—	—	—
40	43	43	—	—	—	—	—	—	—	—	—	—	—
60	—	—	51, 52	53	—	52	—	—	—	524	534	—	—
70	73	73	—	73	—	—	—	72	—	—	—	—	—
100	—	—	81, 102	103	53 (Note 1)	102	—	—	—	1024	734, 1034	534 (Note 1)	—
200	—	—	121, 201, 152, 202	153, 203	73, 103 (Note 1)	152	103, 153	152	—	1524, 2024	1534, 2034	734, 1034 (Note 1)	—
350	—	—	301, 352	353	153, 203 (Note 1)	202	203	202	—	3524	3534	1534, 2034 (Note 1)	—
500	—	—	421, 502	503	353 (Note 1)	302	353, 503	352, 502	502	5024	5034	3534 (Note 1)	—
700	—	—	702	703	503 (Note 1)	—	—	—	601, 701M, 702	7024	7034	5034 (Note 1)	6014, 701M4
11K	—	—	—	903, 11K1M (Note 2)	—	—	—	—	801, 12K1, 11K1M, 11K2	—	9034, 11K1M4 (Note 2)	—	8014, 12K14, 11K1M4, 11K24
15K	—	—	—	15K1M (Note 2)	—	—	—	—	15K1, 15K1M, 15K2	—	15K1M4 (Note 2)	—	15K14, 15K1M4, 15K24
22K	—	—	—	—	—	—	—	—	20K1, 25K1, 22K1M, 22K2	—	—	—	20K14, 22K1M4, 22K24

Notes: 1. Use this servo motor when increasing the maximum torque.
 2. Use a dedicated servo amplifier MR-J3-□S-LR-LW for HF-JP11K1M(4) and HF-JP15K1M(4). These servo motors cannot be used with any other servo amplifiers without "LR/LW".

*The servo amplifiers above conform to EN, UL and c-UL standards.

Model designation
Servo motors
Servo amplifiers
Options
Peripheral equipment
MR-J3-BSafety
MR-J3W series
Servo support software
Cautions
Warranty
Global FA centers

MELSERVO-J3

For Drive Unit/Converter Unit Model Designation

■For drive unit 200VAC/400VAC

MR-J3-DU **30K** **B** **S**

Mitsubishi general-purpose
AC servo amplifier
MELSERVO-J3 Series

B: SSCNET III compatible

Drive Safety integrated

Symbol	Power supply
None	3-phase 200VAC
4	3-phase 400VAC

**Converter unit
(MR-J3-CR55K(4))
is required for the
drive unit.**

Symbol	Rated output (kW)	Compatible servo motor
		HA-LP
30K	30	30K1, 30K1M, 30K2, 25K14, 30K14, 30K1M4, 30K24
37K	37	37K1, 37K1M, 37K2, 37K14, 37K1M4, 37K24
45K	45	45K1M4, 45K24
55K	55	50K1M4, 55K24

■For converter unit 200VAC/400VAC

MR-J3-CR **55K**

Mitsubishi general-purpose
AC servo amplifier
MELSERVO-J3 Series

Rated output: 55kW

Symbol	Power supply
None	3-phase 200VAC
4	3-phase 400VAC

* The drive unit and the converter unit conform to EN, UL and c-UL standards.



MR-J3-B Safety Servo Amplifier Specifications: 100VAC/200VAC, 22kW or Smaller

Servo amplifier model		MR-J3-□S													MR-J3-□S1		
		10B	20B	40B	60B	70B	100B	200B	350B	500B	700B	11KB	15KB	22KB	10B	20B	40B
Output	Rated voltage	3-phase 170VAC															
	Rated current (A)	1.1	1.5	2.8	3.2	5.8	6.0	11.0	17.0	28.0	37.0	68.0	87.0	126.0	1.1	1.5	2.8
Main circuit power supply	Voltage/frequency (Note 1, 2)	3-phase 200 to 230VAC 50/60Hz or 1-phase 200 to 230VAC 50/60Hz (Note 10)					3-phase 200 to 230VAC 50/60Hz							1-phase 100 to 120VAC 50/60Hz			
	Rated current (A)	0.9	1.5	2.6	3.2	3.8	5.0	10.5	16.0	21.7	28.9	46.0	64.0	95.0	3.0	5.0	9.0
	Permissible voltage fluctuation	For 3-phase 200 to 230VAC: 3-phase 170 to 253VAC For 1-phase 200 to 230VAC: 1-phase 170 to 253VAC (Note 10)					3-phase 170 to 253VAC							1-phase 85 to 132VAC			
	Permissible frequency fluctuation	±5% maximum															
Control circuit power supply	Voltage/frequency	1-phase 200 to 230VAC 50/60Hz (Note 10)					1-phase 200 to 230VAC 50/60Hz							1-phase 100 to 120VAC 50/60Hz			
	Rated current (A)	0.2					0.3					0.4					
	Permissible voltage fluctuation	1-phase 170 to 253VAC (Note 10)					1-phase 170 to 253VAC							1-phase 85 to 132VAC			
	Permissible frequency fluctuation	±5% maximum															
	Power consumption (W)	30					45					30					
Interface power supply		24VDC ±10% (required current capacity: 0.2A (including CN8 connector signals) (Note 7))															
Tolerable regenerative power of regenerative resistor (W) (Note 3, 4)	Built-in regenerative resistor	—	10	10	10	20	20	100	100	130	170	—	—	—	—	10	10
	External regenerative resistor (Standard accessory) (Note 5, 6)	—	—	—	—	—	—	—	—	—	—	500 (800)	850 (1300)	850 (1300)	—	—	—
Control system		Sine-wave PWM control/current control system															
Dynamic brake		Built-in (Note 8, 11)										External option (Note 12)			Built-in (Note 8, 11)		
Safety features		Overcurrent shutdown, regeneration overvoltage shutdown, overload shutdown (electronic thermal), servo motor overheat protection, encoder fault protection, regeneration fault protection, undervoltage/sudden power outage protection, overspeed protection, excess error protection															
Response performance		8ms or less (STO input OFF → energy shut off)															
Safety function		STO (EN IEC 61800-5-2)															
Safety performance		EN ISO 13849-1 PL d (Category 3), IEC/EN 61508 SIL 2, EN 62061 SIL CL 2															
Mean time to dangerous failure (MTTFd)		100 years															
Diagnostic converge (DC)		90%															
Average probability of dangerous failures per hour (PFH)		1.01 × 10 ⁻⁷ (1/h)															
Compliance to standards		CE (LVD: EN 50178, EMC: EN 61800-3) UL (UL 508C)															
Structure (IP rating)		Natural-cooling open (IP00)					Fan cooling open (IP00)							Natural-cooling open (IP00)			
Environment	Ambient temperature (Note 9)	0 to 55°C (32 to 131°F) (non freezing), storage: -20 to 65°C (-4 to 149°F) (non freezing)															
	Ambient humidity	90% RH maximum (non condensing), storage: 90% RH maximum (non condensing)															
	Atmosphere	Indoors (no direct sunlight); no corrosive gas, inflammable gas, oil mist or dust															
	Elevation	1000m or less above sea level															
	Vibration	5.9m/s ² or less at 10 to 55Hz (directions of X, Y and Z axes)															
Mass (kg [lb])		0.8 (1.8)	0.8 (1.8)	1.0 (2.2)	1.0 (2.2)	1.4 (3.1)	1.4 (3.1)	2.1 (4.6)	2.3 (5.1)	4.6 (10)	6.2 (14)	18 (40)	18 (40)	19 (42)	0.8 (1.8)	0.8 (1.8)	1.0 (2.2)

- Notes: 1. Rated output and speed of a servo motor are applicable when the servo amplifier, combined with the servo motor, is operated within the specified power supply voltage and frequency. Torque drops when the power supply voltage is below the specified value.
2. For torque characteristics when combined with a servo motor, refer to the section "Servo motor torque characteristics" in this catalog.
3. Optimal regenerative resistor varies for each system. Select the most suitable regenerative resistor by using the capacity selection software.
4. Refer to the section "Options ● Optional regeneration unit" in this catalog for the tolerable regenerative power (W).
5. Servo amplifiers without an enclosed regenerative resistor are also available. Refer to "Servo Amplifier Model Designation" in this catalog for details.
6. The value in () is applicable when the external regenerative resistors, GRZG400-□Ω (standard accessory) are used with cooling fans (2 units of 92 × 92mm, minimum air flow: 1.0m³/min). Note that change in parameter No. PA02 is required.
7. 0.2A is the value when all of the input/output points are used. The current capacity can be stepped down according to the number of input/output points in use. Refer to "MR-J3-□B Safety SERVO AMPLIFIER INSTRUCTION MANUAL" for details.
8. Special specification servo amplifiers without a dynamic brake are also available: MR-J3-□S(1)-ED. When using the servo amplifier without a dynamic brake the servo motor does not stop immediately at alarm occurrence or power failure. Take measures to ensure safety on the entire system.
9. MR-J3-350□S or smaller servo amplifiers can be mounted closely. In this case, operate them at the ambient temperature of 0 to 45°C (32 to 113°F) or at 75% or less of the effective load ratio.
10. Special specification servo amplifiers for 1-phase 200 to 240VAC are also available: MR-J3-□S-U004. The permissible voltage fluctuation for MR-J3-□S-U004 is 1-phase 170 to 264VAC.
11. When using the built-in dynamic brake, refer to "MR-J3-□B Safety SERVO AMPLIFIER INSTRUCTION MANUAL" for the permissible load to motor inertia moment ratio.
12. Use an optional external dynamic brake with the servo amplifier. Without the external dynamic brake, a servo motor does not stop immediately at emergency stop and falls in free-run status, causing an accident such as machine collision, etc. Take measures to ensure safety on the entire system.



MR-J3-BSafety Servo Amplifier Specifications: 200VAC, 30kW or Larger

Drive unit model MR-J3-DU□S		30KB	37KB
Output	Rated voltage	3-phase 170VAC	
	Rated current (A)	174	204
Main circuit power supply		The drive unit's main circuit power is supplied from the converter unit.	
Control circuit power supply	Voltage/frequency	1-phase 200 to 230VAC 50/60Hz	
	Rated current (A)	0.3	
	Permissible voltage fluctuation	1-phase 170 to 253VAC	
	Permissible frequency fluctuation	±5% maximum	
	Power consumption (W)	45	
Interface power supply		24VDC ±10% (required current capacity: 0.2A (including CN8 connector signals) (Note 3))	
Control system		Sine-wave PWM control/current control system	
Dynamic brake		External option (Note 4)	
Safety features		Overcurrent shutdown, overload shutdown (electronic thermal), servo motor overheat protection, encoder fault protection, undervoltage/sudden power outage protection, overspeed protection, excess error protection	
Response performance		8ms or less (STO input OFF → energy shut off)	
Safety function		STO (EN IEC 61800-5-2)	
Safety performance		EN ISO 13849-1 PL d (Category 3), IEC/EN 61508 SIL 2, EN 62061 SIL CL 2	
Mean time to dangerous failure (MTTFd)		100 years	
Diagnostic converge (DC)		90%	
Average probability of dangerous failures per hour (PFH)		1.01 × 10 ⁻⁷ (1/h)	
Compliance to standards		CE (LVD: EN 50178, EMC: EN 61800-3) UL (UL 508C)	
Structure (IP rating)		Fan cooling open (IP00)	
Mass (kg [lb])		26 (57)	
Converter unit model		MR-J3-CR55K	
Output	Rated voltage	283 to 326VDC	
	Rated current (A)	215.9	
Main circuit power supply	Voltage/frequency (Note 1, 2)	3-phase 200 to 230VAC 50/60Hz	
	Rated current (A)	251.1	
	Permissible voltage fluctuation	3-phase 170 to 253VAC	
	Permissible frequency fluctuation	±5% maximum	
Control circuit power supply	Voltage/frequency	1-phase 200 to 230VAC 50/60Hz	
	Rated current (A)	0.3	
	Permissible voltage fluctuation	1-phase 170 to 253VAC	
	Permissible frequency fluctuation	±5% maximum	
	Power consumption (W)	45	
Interface power supply		24VDC ±10% (required current capacity: 0.13A (Note 3))	
Safety features		Regeneration overvoltage shutdown, regeneration fault protection, overload shutdown (electronic thermal), undervoltage/sudden power outage protection	
Compliance to standards		CE (LVD: EN 50178, EMC: EN 61800-3) UL (UL 508C)	
Structure (IP rating)		Fan cooling open (IP00)	
Mass (kg [lb])		25 (55)	
Drive unit/ Converter unit	Environment	Ambient temperature	0 to 55°C (32 to 131°F) (non freezing), storage: -20 to 65°C (-4 to 149°F) (non freezing)
		Ambient humidity	90% RH maximum (non condensing), storage: 90% RH maximum (non condensing)
		Atmosphere	Indoors (no direct sunlight); no corrosive gas, inflammable gas, oil mist or dust
		Elevation	1000m or less above sea level
		Vibration	5.9m/s ² or less at 10 to 55Hz (directions of X, Y and Z axes)

- Notes: 1. Rated output and speed of a servo motor are applicable when the drive unit and the converter unit, combined with the servo motor, are operated within the specified power supply voltage and frequency. Torque drops when the power supply voltage is below the specified value.
 2. For torque characteristics when combined with a servo motor, refer to the section "Servo motor torque characteristics" in this catalog.
 3. The interface power supply can be shared with the drive unit and the converter unit. When all of the input/output points are used, 0.2A is required for the drive unit, and 0.13A is required for the converter unit. The current capacity can be stepped down according to the number of input/output points in use. Refer to "MR-J3-□B Safety SERVO AMPLIFIER INSTRUCTION MANUAL" for details.
 4. Use an optional external dynamic brake with the drive unit. Without the external dynamic brake, a servo motor does not stop immediately at emergency stop and falls in free-run status, causing an accident such as machine collision, etc. Take measures to ensure safety on the entire system.



MR-J3-BSafety Servo Amplifier Specifications: 400VAC, 22kW or Smaller

Servo amplifier model MR-J3-□S4		60B	100B	200B	350B	500B	700B	11KB	15KB	22KB	
Output	Rated voltage	3-phase 323VAC									
	Rated current (A)	1.5	2.8	5.4	8.6	14.0	17.0	32.0	41.0	63.0	
Main circuit power supply	Voltage/frequency (Note 1, 2)	3-phase 380 to 480VAC 50/60Hz									
	Rated current (A)	1.4	2.5	5.1	7.9	10.8	14.4	23.1	31.8	47.6	
	Permissible voltage fluctuation	3-phase 323 to 528VAC									
	Permissible frequency fluctuation	±5% maximum									
Control circuit power supply	Voltage/frequency	1-phase 380 to 480VAC 50/60Hz									
	Rated current (A)	0.1				0.2					
	Permissible voltage fluctuation	1-phase 323 to 528VAC									
	Permissible frequency fluctuation	±5% maximum									
Interface power supply		24VDC ±10% (required current capacity: 0.2A (including CN8 connector signals) (Note 7))									
Tolerable regenerative power of regenerative resistor (W) (Note 3, 4)	Built-in regenerative resistor	15	15	100	100	130 (Note 9)	170 (Note 9)	—	—	—	
	External regenerative resistor (Standard accessory) (Note 5, 6)	—	—	—	—	—	—	500 (800)	850 (1300)	850 (1300)	
Control system		Sine-wave PWM control/current control system									
Dynamic brake		Built-in (Note 8, 10)						External option (Note 11)			
Safety features		Overcurrent shutdown, regeneration overvoltage shutdown, overload shutdown (electronic thermal), servo motor overheat protection, encoder fault protection, regeneration fault protection, undervoltage/sudden power outage protection, overspeed protection, excess error protection									
Response performance		8ms or less (STO input OFF → energy shut off)									
Safety function		STO (EN IEC 61800-5-2)									
Safety performance		EN ISO 13849-1 PL d (Category 3), IEC/EN 61508 SIL 2, EN 62061 SIL CL 2									
Mean time to dangerous failure (MTTFd)		100 years									
Diagnostic converge (DC)		90%									
Average probability of dangerous failures per hour (PFH)		1.01 × 10 ⁻⁷ (1/h)									
Compliance to standards		CE (LVD: EN 50178, EMC: EN 61800-3) UL (UL 508C)									
Structure (IP rating)		Natural-cooling open (IP00)				Fan cooling open (IP00)					
Environment	Ambient temperature	0 to 55°C (32 to 131°F) (non freezing), storage: -20 to 65°C (-4 to 149°F) (non freezing)									
	Ambient humidity	90% RH maximum (non condensing), storage: 90% RH maximum (non condensing)									
	Atmosphere	Indoors (no direct sunlight); no corrosive gas, inflammable gas, oil mist or dust									
	Elevation	1000m or less above sea level									
Vibration		5.9m/s ² or less at 10 to 55Hz (directions of X, Y and Z axes)									
Mass (kg [lb])		1.7 (3.7)	1.7 (3.7)	2.1 (4.6)	4.6 (10)	4.6 (10)	6.2 (14)	18 (40)	18 (40)	19 (42)	

- Notes: 1. Rated output and speed of a servo motor are applicable when the servo amplifier, combined with the servo motor, is operated within the specified power supply voltage and frequency. Torque drops when the power supply voltage is below the specified value.
 2. For torque characteristics when combined with a servo motor, refer to the section "Servo motor torque characteristics" in this catalog.
 3. Optimal regenerative resistor varies for each system. Select the most suitable regenerative resistor by using the capacity selection software.
 4. Refer to the section "Options ●Optional regeneration unit" in this catalog for the tolerable regenerative power (W).
 5. Servo amplifiers without an enclosed regenerative resistor are also available. Refer to "Servo Amplifier Model Designation" in this catalog for details.
 6. The value in () is applicable when the external regenerative resistors, GRZG400-□Ω (standard accessory) are used with cooling fans (2 units of 92 × 92mm, minimum air flow: 1.0m³/min). Note that change in parameter No. PA02 is required.
 7. 0.2A is the value when all of the input/output points are used. The current capacity can be stepped down according to the number of input/output points in use. Refer to "MR-J3-□B Safety SERVO AMPLIFIER INSTRUCTION MANUAL" for details.
 8. Special specification servo amplifiers without a dynamic brake are also available: MR-J3-□S4-ED. When using the servo amplifier without a dynamic brake, the servo motor does not stop immediately at alarm occurrence or power failure. Take measures to ensure safety on the entire system.
 9. The servo amplifier built-in regenerative resistor is compatible with the maximum torque deceleration when the motor is used within the rated speed and the recommended load to motor inertia moment ratio. Contact your local sales office if the operating motor speed and the load to motor inertia moment ratio exceed the rated speed and the recommended ratio.
 10. When using the built-in dynamic brake, refer to "MR-J3-□B Safety SERVO AMPLIFIER INSTRUCTION MANUAL" for the permissible load to motor inertia moment ratio.
 11. Use an optional external dynamic brake with the servo amplifier. Without the external dynamic brake, a servo motor does not stop immediately at emergency stop and falls in free-run status, causing an accident such as machine collision, etc. Take measures to ensure safety on the entire system.

Model designation
 Servo motors
 Servo amplifiers
 Options
 Peripheral equipment
 MR-J3-BSafety
 MR-J3W series
 Servo support software
 Cautions
 Warranty
 Global FA centers



MR-J3-BSafety Servo Amplifier Specifications: 400VAC, 30kW or Larger

Drive unit model MR-J3-DU□S4		30KB	37KB	45KB	55KB
Output	Rated voltage	3-phase 323VAC			
	Rated current (A)	87	102	131	143
Main circuit power supply		The drive unit's main circuit power is supplied from the converter unit.			
Control circuit power supply	Voltage/frequency	1-phase 380 to 480VAC 50/60Hz			
	Rated current (A)	0.2			
	Permissible voltage fluctuation	1-phase 323 to 528VAC			
	Permissible frequency fluctuation	±5% maximum			
	Power consumption (W)	45			
Interface power supply		24VDC ±10% (required current capacity: 0.2A (including CN8 connector signals) (Note 3))			
Control system		Sine-wave PWM control/current control system			
Dynamic brake		External option (Note 4)			
Safety features		Overcurrent shutdown, overload shutdown (electronic thermal), servo motor overheat protection, encoder fault protection, undervoltage/sudden power outage protection, overspeed protection, excess error protection			
Response performance		8ms or less (STO input OFF → energy shut off)			
Safety function		STO (EN IEC 61800-5-2)			
Safety performance		EN ISO 13849-1 PL d (Category 3), IEC/EN 61508 SIL 2, EN 62061 SIL CL 2			
Mean time to dangerous failure (MTTFd)		100 years			
Diagnostic converge (DC)		90%			
Average probability of dangerous failures per hour (PFH)		1.01 × 10 ⁻⁷ (1/h)			
Compliance to standards		CE (LVD: EN 50178, EMC: EN 61800-3) UL (UL 508C)			
Structure (IP rating)		Fan cooling open (IP00)			
Mass (kg [lb])		18.5 (41)		26 (57)	
Converter unit model		MR-J3-CR55K4			
Output	Rated voltage	538 to 678VDC			
	Rated current (A)	113.8			
Main circuit power supply	Voltage/frequency (Note 1, 2)	3-phase 380 to 480VAC 50/60Hz			
	Rated current (A)	132.2			
	Permissible voltage fluctuation	3-phase 323 to 528VAC			
	Permissible frequency fluctuation	±5% maximum			
Control circuit power supply	Voltage/frequency	1-phase 380 to 480VAC 50/60Hz			
	Rated current (A)	0.2			
	Permissible voltage fluctuation	1-phase 323 to 528VAC			
	Permissible frequency fluctuation	±5% maximum			
	Power consumption (W)	45			
Interface power supply		24VDC ±10% (required current capacity: 0.13A (Note 3))			
Safety features		Regeneration overvoltage shutdown, regeneration fault protection, overload shutdown (electronic thermal), undervoltage/sudden power outage protection			
Compliance to standards		CE (LVD: EN 50178, EMC: EN 61800-3) UL (UL 508C)			
Structure (IP rating)		Fan cooling open (IP00)			
Mass (kg [lb])		25 (55)			
Drive unit/ Converter unit	Environment	Ambient temperature	0 to 55°C (32 to 131°F) (non freezing), storage: -20 to 65°C (-4 to 149°F) (non freezing)		
		Ambient humidity	90% RH maximum (non condensing), storage: 90% RH maximum (non condensing)		
		Atmosphere	Indoors (no direct sunlight); no corrosive gas, inflammable gas, oil mist or dust		
		Elevation	1000m or less above sea level		
		Vibration	5.9m/s ² or less at 10 to 55Hz (directions of X, Y and Z axes)		

- Notes: 1. Rated output and speed of a servo motor are applicable when the drive unit and the converter unit, combined with the servo motor, are operated within the specified power supply voltage and frequency. Torque drops when the power supply voltage is below the specified value.
 2. For torque characteristics when combined with a servo motor, refer to the section "Servo motor torque characteristics" in this catalog.
 3. The interface power supply can be shared with the drive unit and the converter unit. When all of the input/output points are used, 0.2A is required for the drive unit, and 0.13A is required for the converter unit. The current capacity can be stepped down according to the number of input/output points in use. Refer to "MR-J3-□B Safety SERVO AMPLIFIER INSTRUCTION MANUAL" for details.
 4. Use an optional external dynamic brake with the drive unit. Without the external dynamic brake, a servo motor does not stop immediately at emergency stop and falls in free-run status, causing an accident such as machine collision, etc. Take measures to ensure safety on the entire system.

MR-J3-□S□ Standard Wiring Diagram Example

● When used with MR-J3-D05

Main circuit/control circuit power supply connection

The connection differs according to the power voltage.

→Refer to "main/control circuit power supply connection examples" in this catalog.

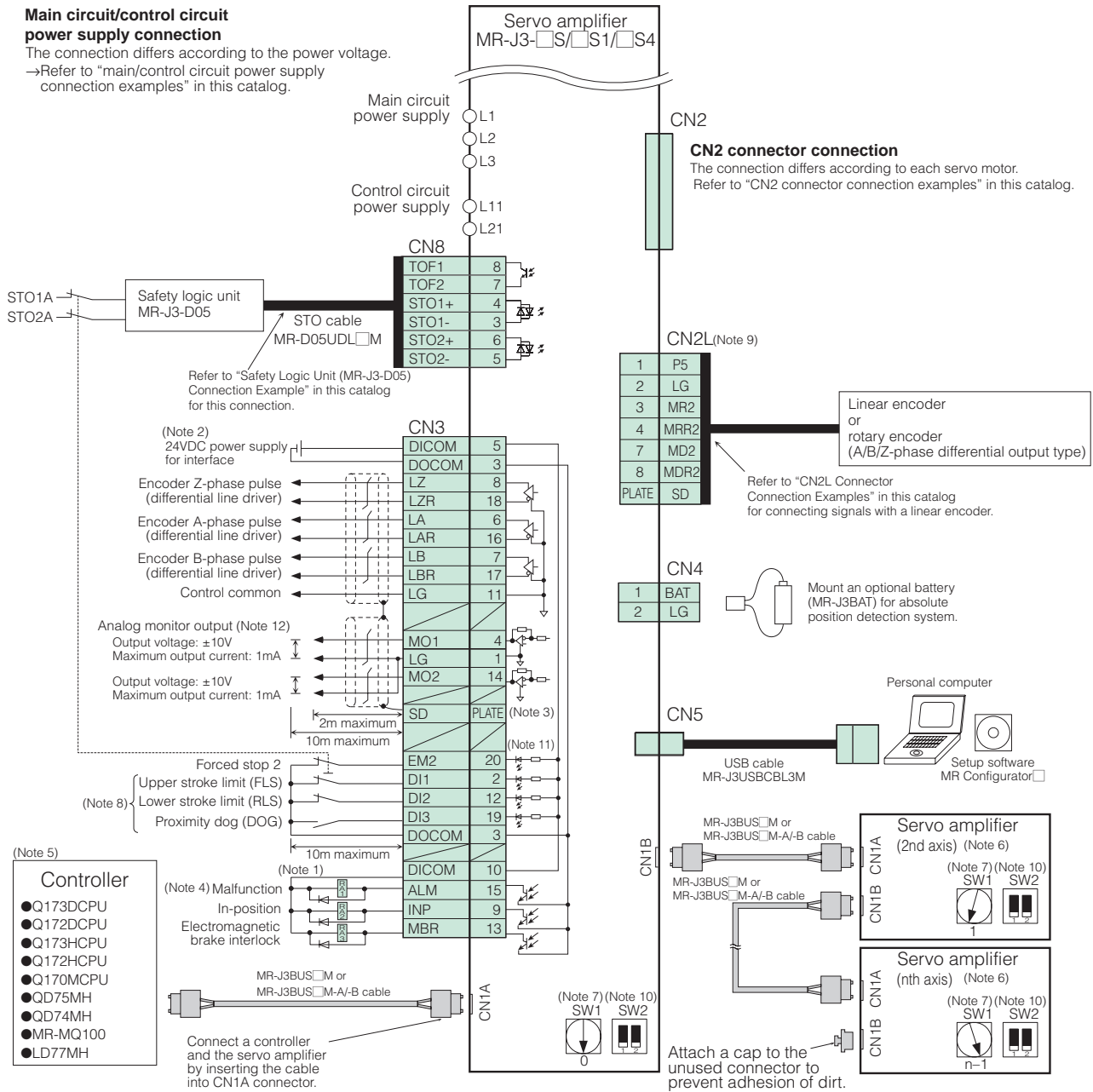

Notes:

- Do not reverse the diode's direction. Connecting it backwards may cause the servo amplifier to malfunction such that the signals are not output, and the forced stop and other safety circuits are inoperable.
- Use the power supply 24VDC±10% (required current capacity: 0.2A). 0.2A is the value when all of the input/output points are used. Note that the current capacity can be stepped down according to the number of input/output points in use. Refer to "MR-J3-□B Safety SERVO AMPLIFIER INSTRUCTION MANUAL" for details.
- Connect the shield wire securely to the plate inside the connector (ground plate).
- The malfunction (ALM) signal (normally closed contact) is conducted to DOCOM in normal alarm-free condition.
- For details on the controllers, refer to relevant controller's programming manual or user's manual.
- Connections for the second and following axes are omitted.
- Up to 16 axes (n = 1 to 16) can be set using the axis selection rotary switch (SW1).
- Devices can be assigned for DI1, DI2 and DI3 with controller setting. Refer to the controller's instruction manuals for details on setting. These devices can be assigned with the controller: Q173DCPU, Q172DCPU, Q173HCPU, Q172HCPU, Q170MCP, QD75MH, QD74MH, MR-MQ100 or LD77MH.
- Use CN2L connector when configuring fully closed loop control system.
- Test operation select switch (SW2-1) is used to perform test operation mode with MR Configurator2 or MR Configurator. SW2-2 is for manufacturer setting.
- This is for sink wiring. Source wiring is also possible. Refer to "MR-J3-□B Safety SERVO AMPLIFIER INSTRUCTION MANUAL" for details.
- Output voltage range varies depending on the monitored signal.

Model designation
Servo motors
Servo amplifiers
Options
Peripheral equipment
MR-J3-B Safety
MR-J3W series
Servo support software
Cautions
Warranty
Global FA centers

MR-J3-□S□ Standard Wiring Diagram Example

● When directly wiring a safety door

Main circuit/control circuit power supply connection

The connection differs according to the power voltage.
→Refer to "main/control circuit power supply connection examples" in this catalog.

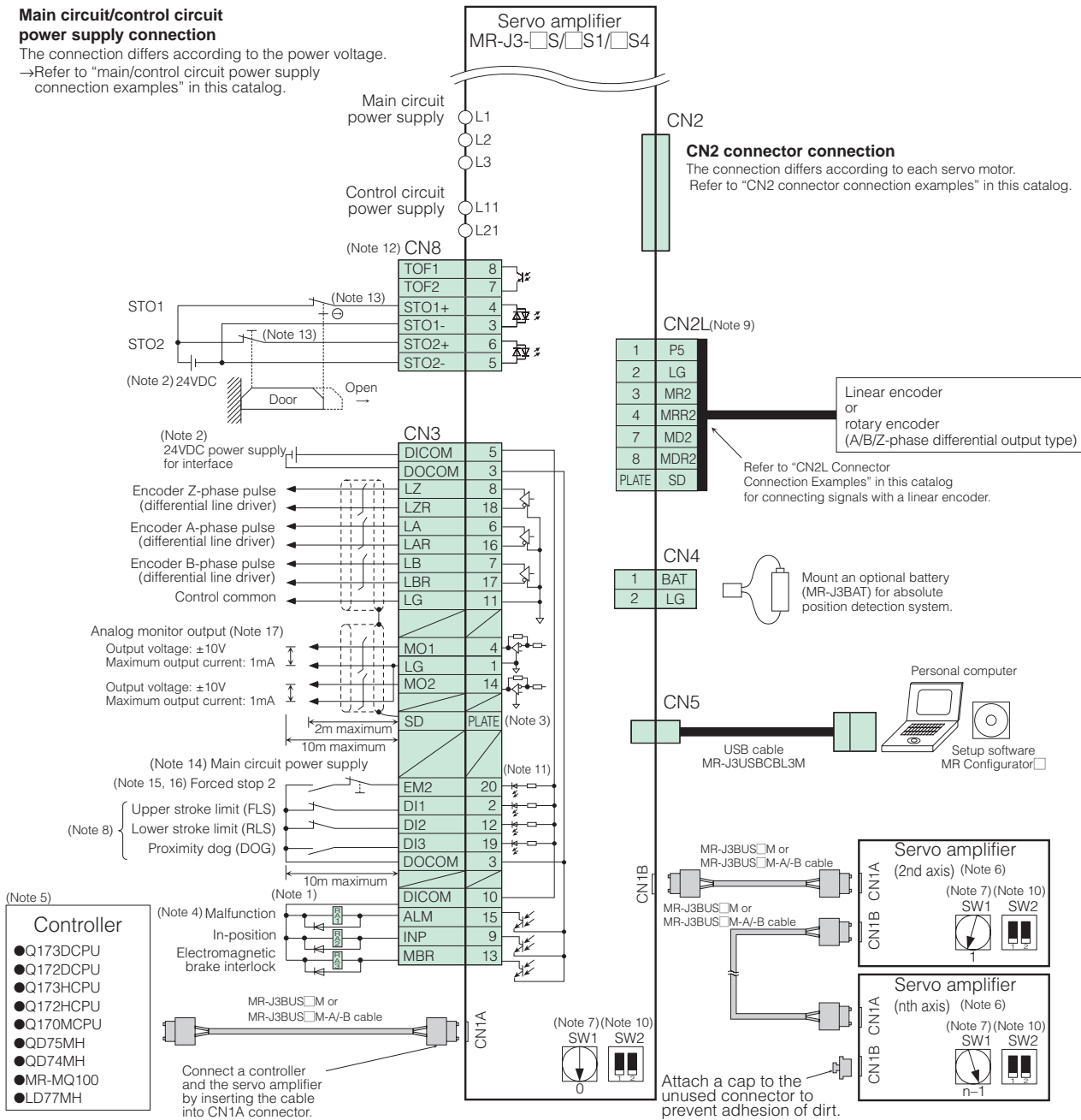

Notes:

- Do not reverse the diode's direction. Connecting it backwards may cause the servo amplifier to malfunction such that the signals are not output, and the forced stop and other safety circuits are inoperable.
- Use the power supply 24VDC±10% (required current capacity: 0.2A). 0.2A is the value when all of the input/output points are used. Note that the current capacity can be stepped down according to the number of input/output points in use. Refer to "MR-J3-□B Safety SERVO AMPLIFIER INSTRUCTION MANUAL" for details.
- Connect the shield wire securely to the plate inside the connector (ground plate).
- The malfunction (ALM) signal (normally closed contact) is conducted to DOCOM in normal alarm-free condition.
- For details on the controllers, refer to controller's relevant programming manual or user's manual.
- Connections for the second and following axes are omitted.
- Up to 16 axes (n = 1 to 16) can be set using the axis selection rotary switch (SW1).
- Devices can be assigned for DI1, DI2 and DI3 with controller setting. Refer to the controller's instruction manuals for details on setting. These devices can be assigned with the controller: Q173DCPU, Q172DCPU, Q173HCPU, Q172HCPU, Q170MCP, QD75MH, QD74MH, MR-MQ100 or LD77MH.
- Use CN2L connector when configuring fully closed loop control system.
- Test operation select switch (SW2-1) is used to perform test operation mode with MR Configurator2 or MR Configurator. SW2-2 is for manufacturer setting.
- This is for sink wiring. Source wiring is also possible. Refer to "MR-J3-□B Safety SERVO AMPLIFIER INSTRUCTION MANUAL" for details.
- Attach a short-circuit connector (standard accessory) when invalidating the STO function.
- When using the STO function, turn off STO1 and STO2 at the same time. Be sure to turn off STO1 and STO2 after the servo motor stops in servo-off state or after the servo motor stops with deceleration by turning off the forced stop 2 (EM2) signal.
- Turn off EM2 when the main circuit power supply is off.
- If the controller does not have a forced stop function, install the forced stop 2 switch (normally closed contact).
- Always turn on the forced stop 2 (EM2) signal (normally closed contact) before starting the operation.
- Output voltage range varies depending on the monitored signal.

Safety Logic Unit (MR-J3-D05) Specifications

The safety logic unit has Safe torque off (STO) and Safe stop 1 (SS1) functions. MR-J3-BSafety servo amplifier realizes Safe stop 1 (SS1) function by adding the MR-J3-D05.

Safety logic unit model		MR-J3-D05
Control circuit power supply	Voltage	24VDC
	Permissible voltage fluctuation	24VDC±10%
	Required current capacity	0.5A (Note 1, 2)
Compatible system		2 systems (A-axis, B-axis independent)
Shut-off input		4 points (2 points × 2 systems) SDI□ : source/sink compatible (Note 3)
Shut-off release input		2 points (1 point × 2 systems) SRES□ : source/sink compatible (Note 3)
Feedback input		2 points (1 point × 2 systems) TOF□ : source compatible (Note 3)
Input method		Photocoupler insulation, 24VDC (external supply), internal limited resistance 5.4kΩ
Shut-off output		8 points (4 points × 2 systems) STO□ : source compatible (Note 3) SDO□ : source/sink compatible (Note 3)
Output method		Photocoupler insulation, Open-collector Permissible current: 40mA or less per output, Inrush current: 100mA or less per output
Response performance (when delay time is set to 0s)		10ms or less (STO input OFF → shut-off output OFF)
Delay time setting		A-axis: select from 0s, 1.4s, 2.8s, 5.6s, 9.8s or 30.8s B-axis: select from 0s, 1.4s, 2.8s, 9.8s or 30.8s Accuracy: ±2%
Safety function		STO, SS1 (EN IEC 61800-5-2) EMG STOP, EMG OFF (EN IEC 60204-1)
Safety performance		EN ISO 13849-1 PL d (Category 3), IEC/EN 61508 SIL 2, EN 62061 SIL CL 2
Mean time to dangerous failure (MTTFd)		100 years
Diagnostic converge (DC)		90%
Average probability of dangerous failures per hour (PFH)		1.01×10^{-7} (1/h)
Structure (IP rating)		Natural-cooling open (IP00)
Environment	Ambient temperature	0 to 55°C (32 to 131°F) (non freezing), storage: -20 to 65°C (-4 to 149°F) (non freezing)
	Ambient humidity	90% RH maximum (non condensing), storage: 90% RH maximum (non condensing)
	Atmosphere	Indoors (no direct sunlight); no corrosive gas, inflammable gas, oil mist or dust
	Elevation	1000m or less above sea level
	Vibration	5.9m/s ² or less at 10 to 55Hz (directions of X, Y and Z axes)
Mass	(kg [lb])	0.2 (0.44) (including CN9 and CN10 connectors)

Notes: 1. Inrush current of approximately 1.5A flows instantaneously when turning the control circuit power supply on. Select an appropriate capacity of a power supply considering the inrush current.

2. Power-ON duration of the safety logic unit is 100,000 times.

3. □ in signal name represents a symbol which indicates a system number and axis name.

MELSERVO-J3

Safety Logic Unit (MR-J3-D05) Connection Example

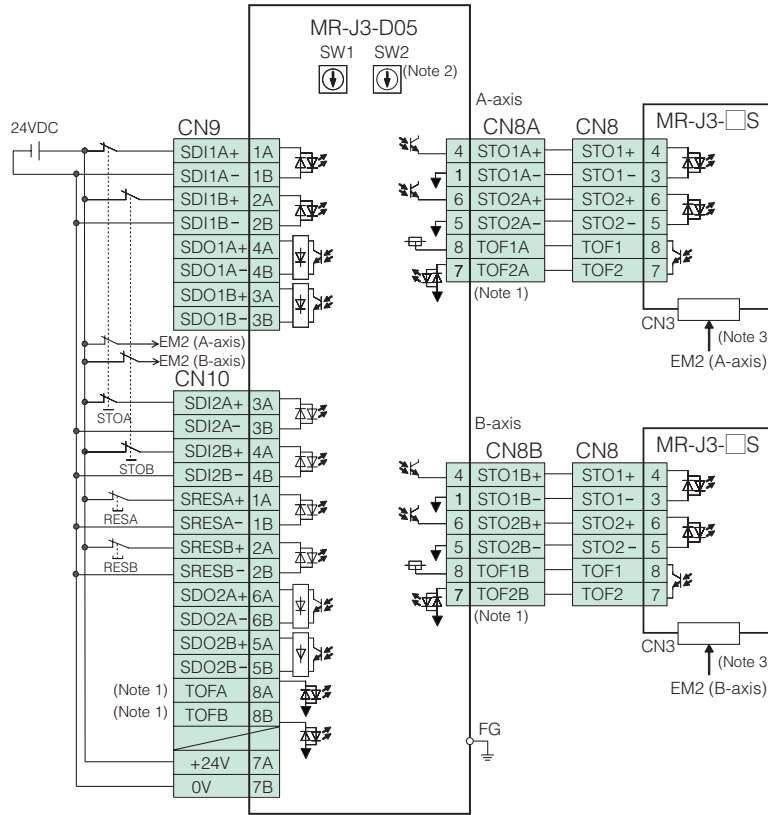

Notes:

1. CN8A-7 pin (TOF2A) and CN10-8A pin (TOFA) carry the same input signal. CN8B-7 pin (TOF2B) and CN10-8B pin (TOFB) also carry the same input signal.
2. Set delay time of STO output with SW1 and SW2.
3. This connection is for source interface.

Safety Logic Unit (MR-J3-D05) Dimensions

(Unit: mm)

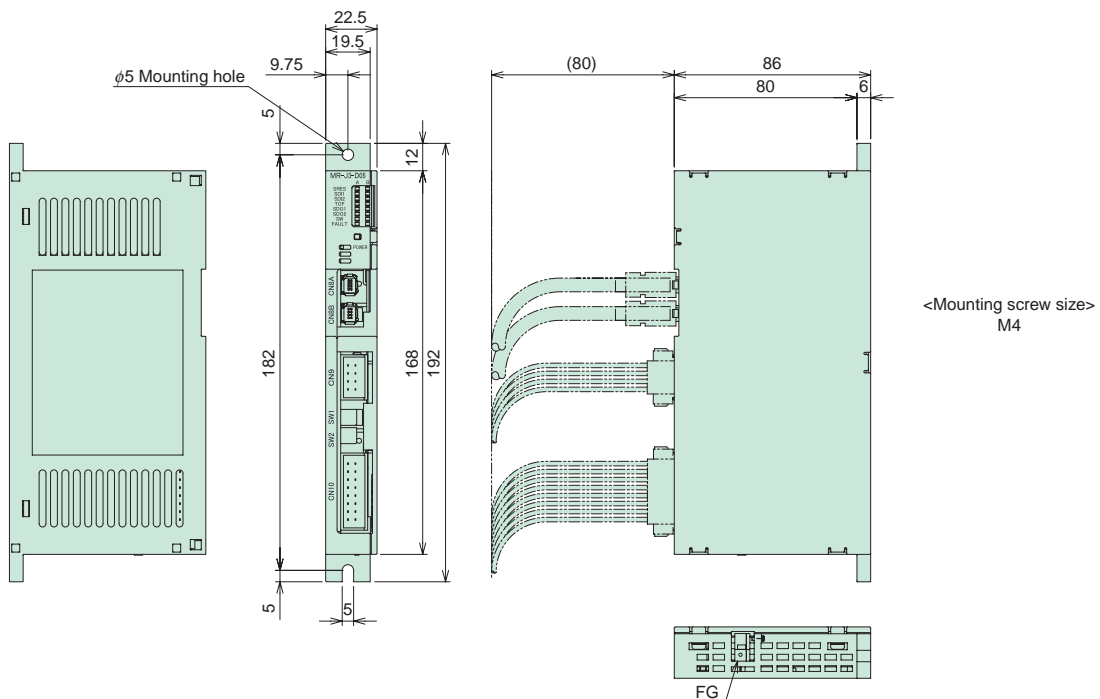

MR-J3-□S□ Servo Amplifier Dimensions

(Unit: mm)

● MR-J3-10□S, 20□S, 10□S1, 20□S1 (Note 1)

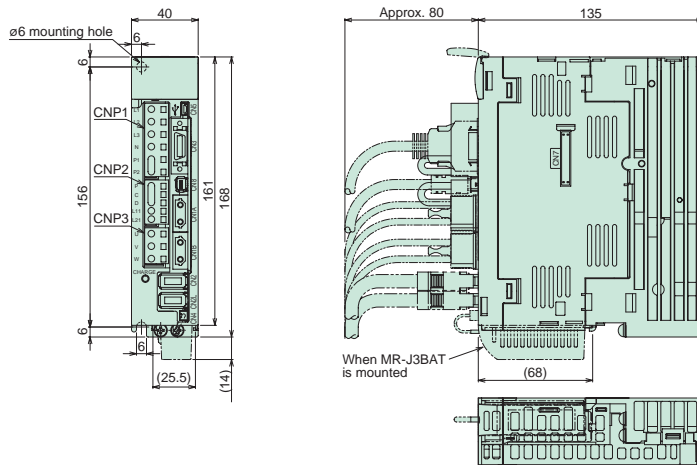

< Terminal arrangement >

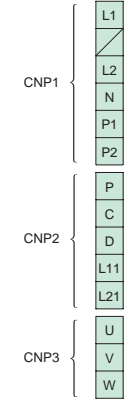

For 1-phase 100VAC

< Terminal arrangement >

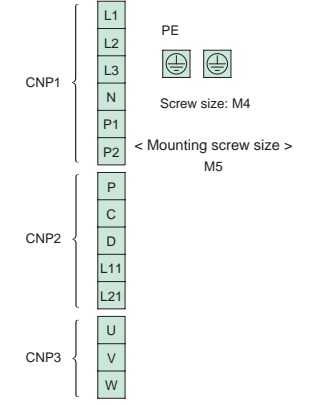

For 3-phase 200VAC or 1-phase 200VAC

● MR-J3-40□S, 60□S, 40□S1 (Note 1)

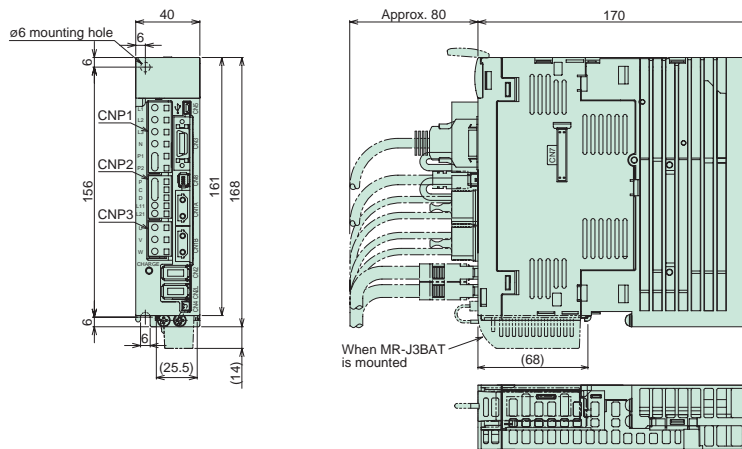

< Terminal arrangement >

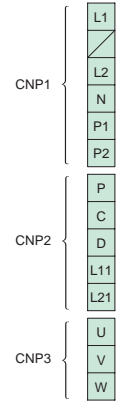

For 1-phase 100VAC

< Terminal arrangement >

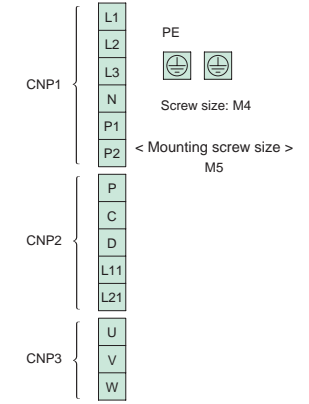

For 3-phase 200VAC or 1-phase 200VAC

● MR-J3-70□S, 100□S (Note 1)

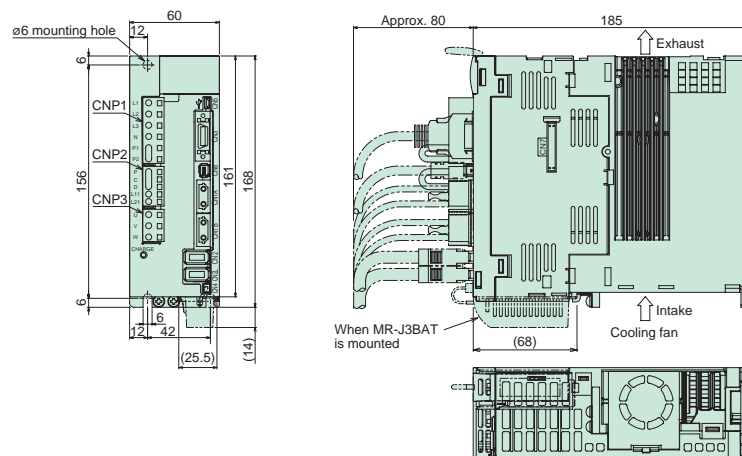

< Terminal arrangement >

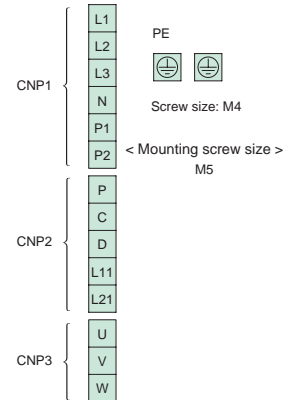

Notes: 1. CNP1, CNP2 and CNP3 connectors (insertion type) are supplied with the servo amplifier.

MELSERVO-J3

MR-J3-□S□ Servo Amplifier Dimensions

(Unit: mm)

● MR-J3-60□S4, 100□S4 (Note 1)

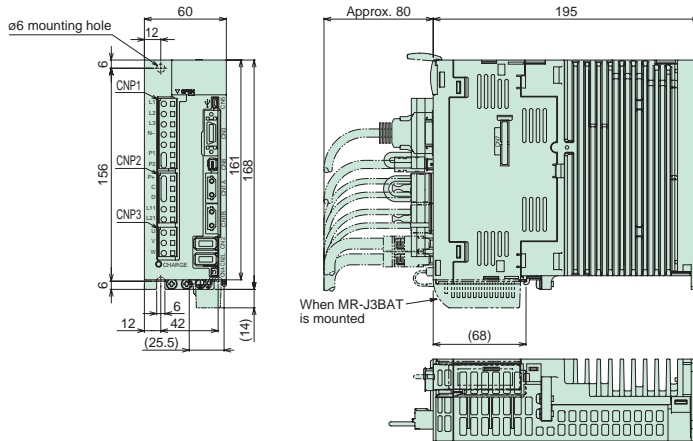

< Terminal arrangement >

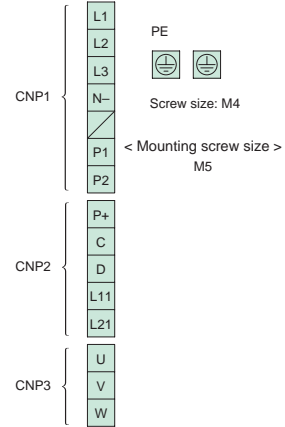

● MR-J3-200□S, 200□S4 (Note 1)

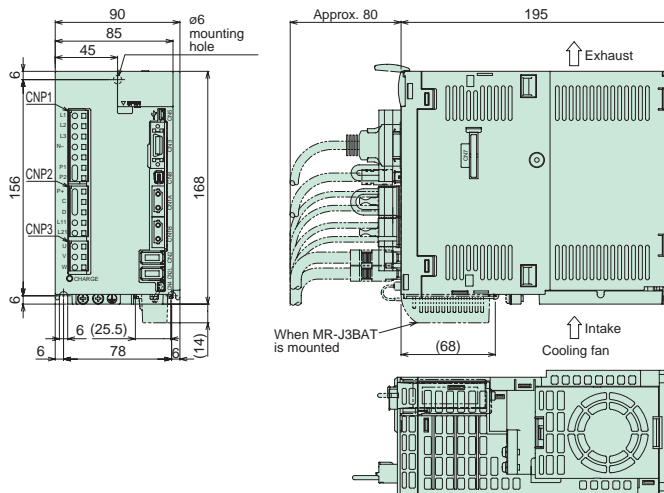

< Terminal arrangement >

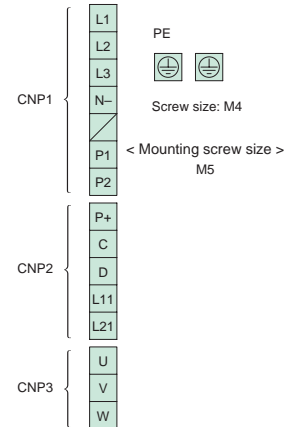

● MR-J3-350□S (Note 1)

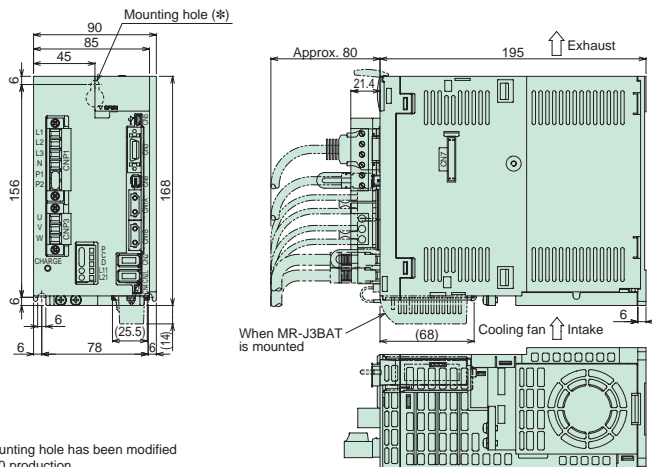

< Terminal arrangement >

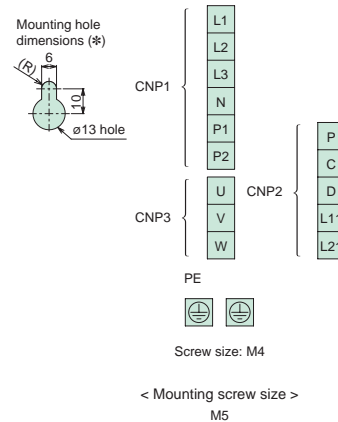

* The shape of the mounting hole has been modified from September 2010 production.

Notes: 1. CNP1, CNP2 and CNP3 connectors (insertion type) are supplied with the servo amplifier.

(Unit: mm)

● MR-J3-500□S, 350□S4, 500□S4

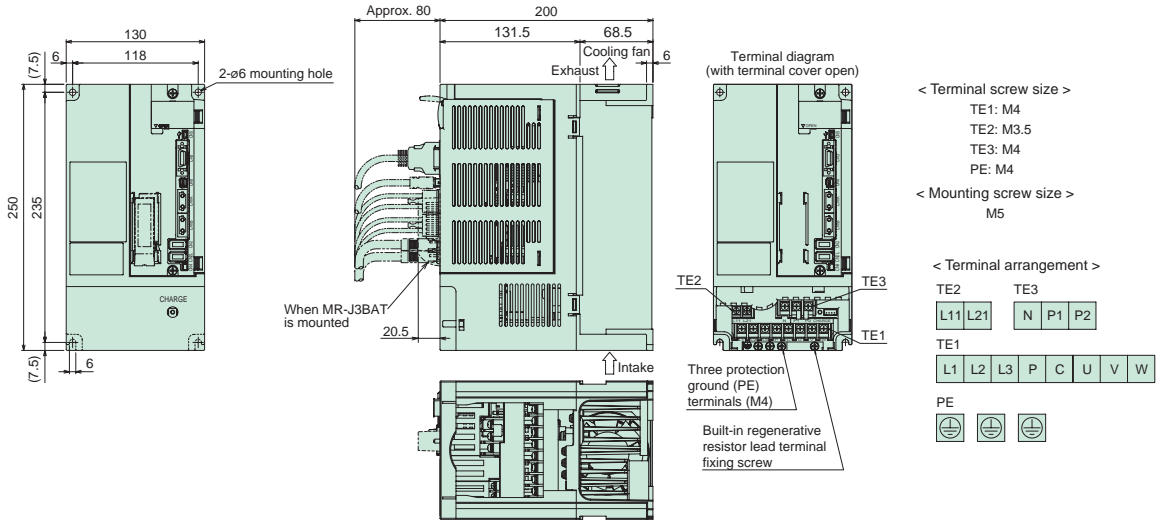

● MR-J3-700□S, 700□S4

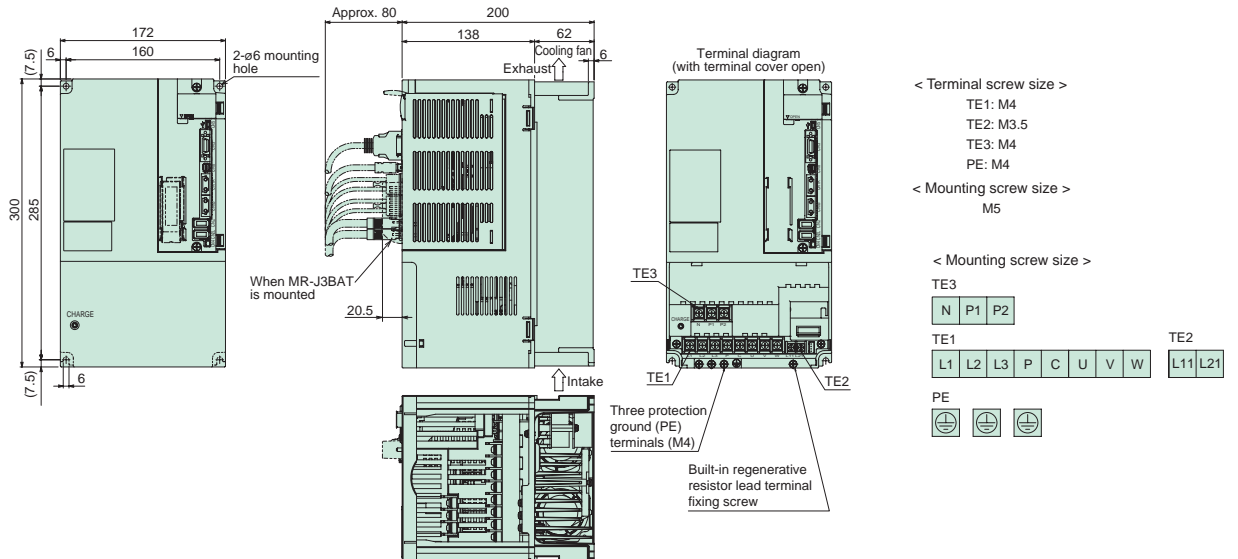

● MR-J3-11K□S to 22K□S, 11K□S4 to 22K□S4

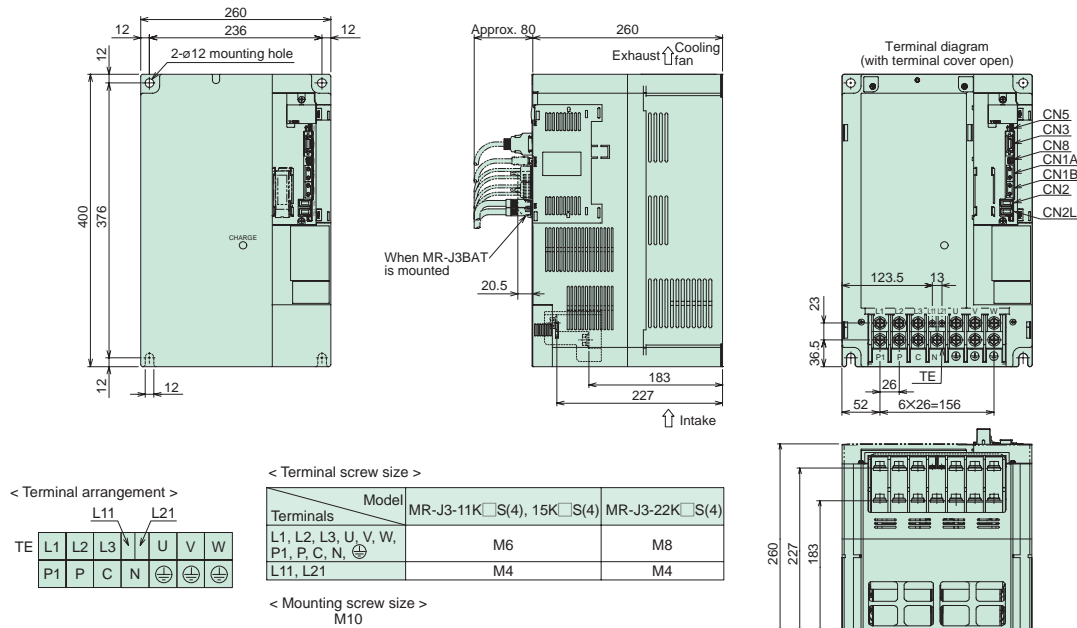

Model designation
Servo motors
Servo amplifiers
Options
Peripheral equipment
MR-J3-BSafety
MR-J3W series
Servo support software
Cautions
Warranty
Global FA centers

Options

● Cables and connectors for MR-J3-BSafety

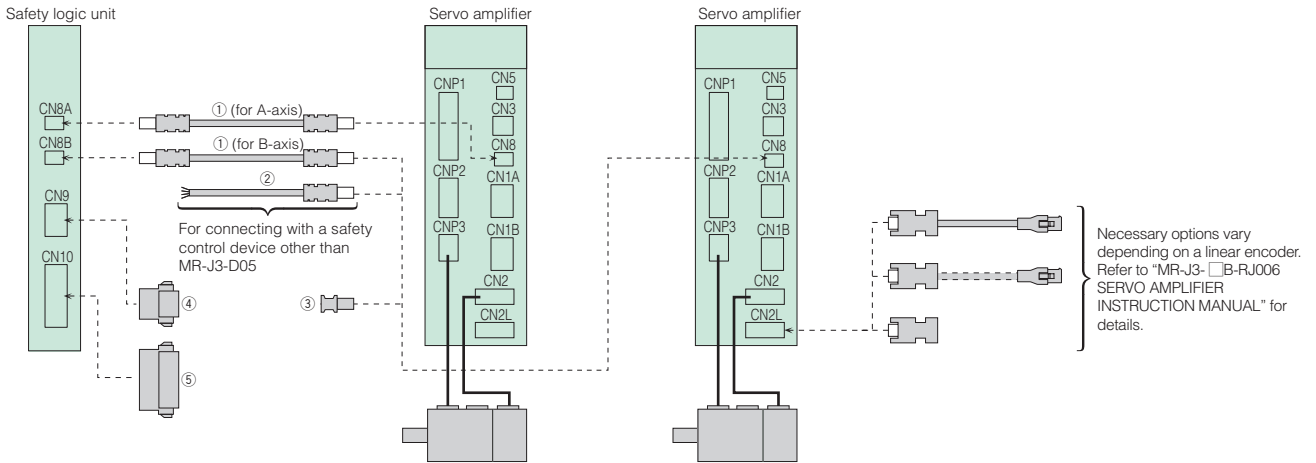

Item		Model	IP rating	Description
For CN8	①	STO cable (for MR-J3-D05)	—	Safety logic unit connector (Tyco Electronics) 2069250-1 (connector set) Amplifier connector (Tyco Electronics) 2069250-1 (connector set)
	②	STO cable (for safety control device other than MR-J3-D05) (Note 2)	—	Amplifier connector (Tyco Electronics) 2069250-1 (connector set)
	③	Short-circuit connector	(Standard accessory)	— This connector is required when not using the STO function.
For CN9	④	Connector	(Standard accessory)	— Safety logic unit connector (Tyco Electronics) 1-1871940-4 (connector)
For CN10	⑤	Connector	(Standard accessory)	— Safety logic unit connector (Tyco Electronics) 1-1871940-8 (connector)

Notes: 1. Refer to "●Cable and connectors for MR-J3-B" and "Cable and connectors for servo motors" for connections with a controller, and for cables and connectors not mentioned in this page.

2. Use this STO cable (MR-D05UDL3M-B) when connecting with a safety control device other than MR-J3-D05.

●Dynamic brake

Refer to P.119 in this catalog.

●Optional regeneration unit

Refer to P.120 in this catalog.

●Battery

Refer to P.124 in this catalog.

●Battery connection relay cable

Refer to P.124 in this catalog.

●Heat sink outside attachment

Refer to P.125 in this catalog.

Peripheral Equipment

●Electrical wires, circuit breakers and magnetic contactors (example of selection)

Refer to P.128 in this catalog.

●Radio noise filter

Refer to P.129 in this catalog.

●Line noise filter

Refer to P.129 in this catalog.

●Data line filter

Refer to P.129 in this catalog.

●Surge killer

Refer to P.129 in this catalog.

●EMC filter

Refer to P.130 in this catalog.

●Power factor improvement DC reactor

Refer to P.132 in this catalog.

●Power factor improvement AC reactor

Refer to P.133 in this catalog.

Connections with Peripheral Equipment

Peripheral equipment is connected to MR-J3W-B as described below.

Connectors, cables, options, and other necessary equipment are available so that users can set up MR-J3W-B easily and start using it right away.

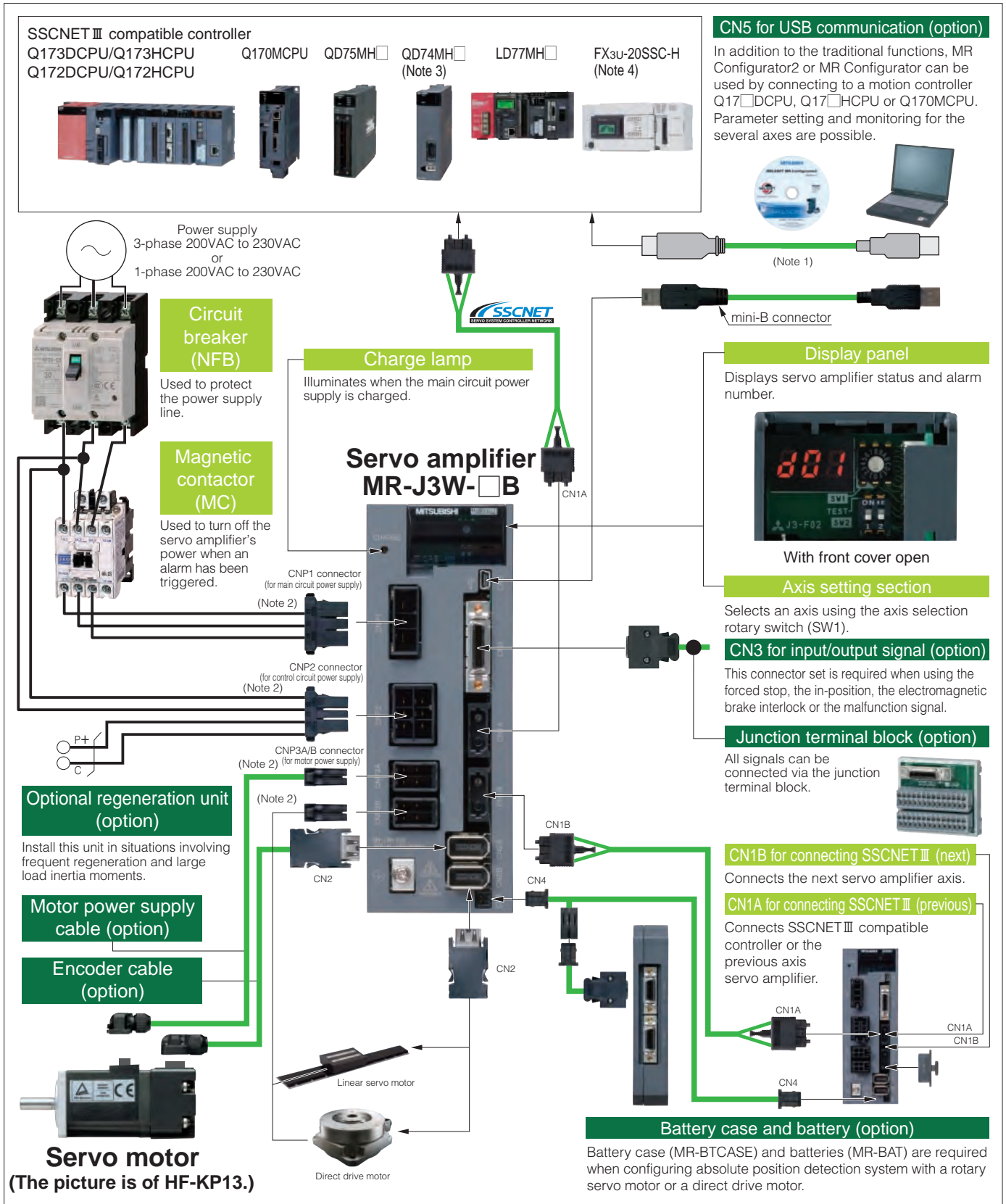

- Notes: 1. Cable for connecting a controller and a personal computer must be prepared by the user. Refer to relevant User's Manual for details.
 2. CNP1, CNP2 and CNP3A/B connector sets are not included with the servo amplifier. Please purchase them separately. Refer to "Option ●Cables and connectors for MR-J3W series" for more details.
 3. The direct drive motor cannot be used with QD74MH.
 4. The linear servo motor and the direct drive motor cannot be used with FX3U-20SSC-H.

MELSERVO-J3W

MR-J3W-B (2-axis Servo Amplifier) Features

- With the same high performance, functionality and usability of the MR-J3-B servo amplifier, one unit of MR-J3W-B servo amplifier operates any combination of two rotary/linear servo motors or direct drive motors.
- Mounting area can be reduced by approximately 17% to 25% as compared to that of 2 units of MR-J3-B servo amplifiers; thus, a more compact system can be realized.

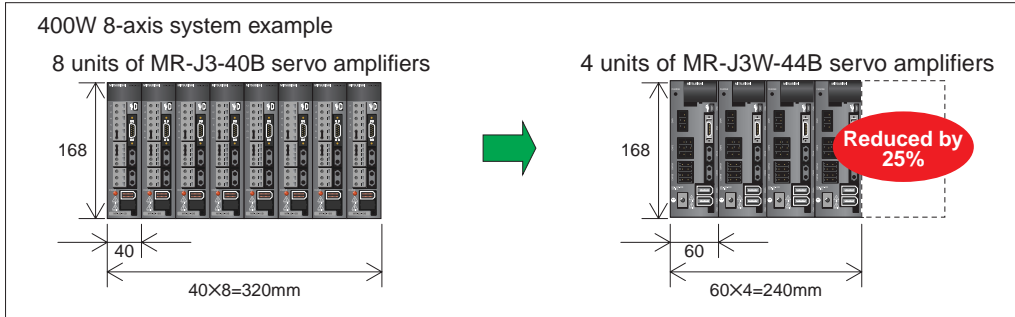

- The two axes use the same main and control supply, and SSCNET III cables. Thus, wiring is greatly reduced.

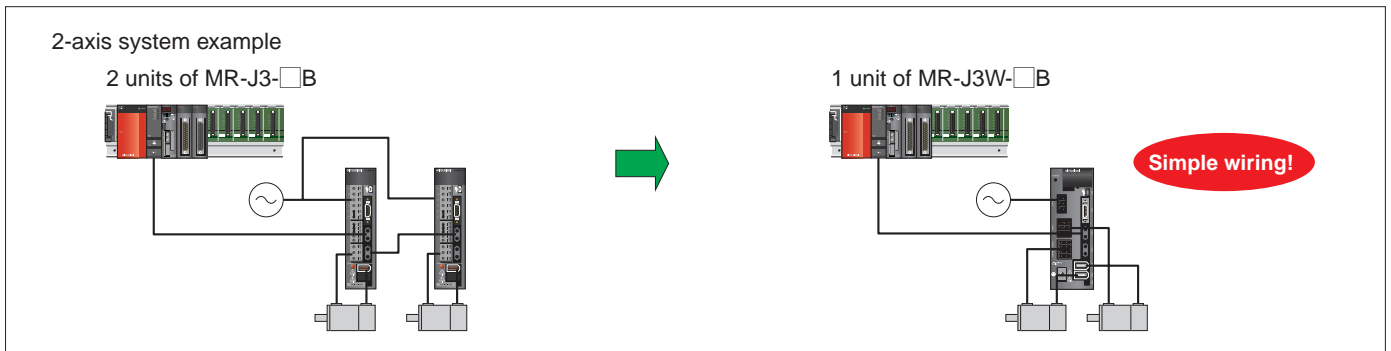

- Reusable regenerative energy stored in the capacitor is increased by 189% to 256% as compared to MR-J3-B servo amplifier. Regenerative energy of 17J to 46J can be reused, contributing to energy-saving.

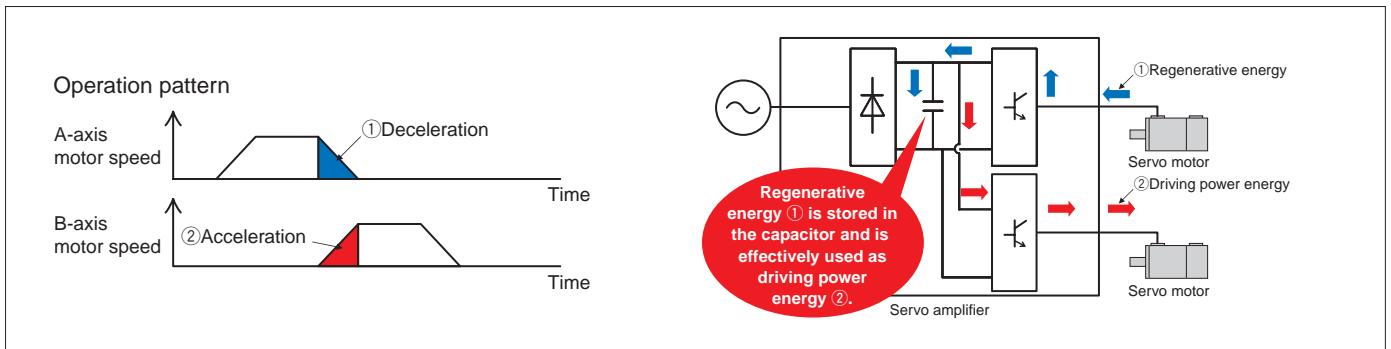

- The following servo motors can be used by switching the servo motor select switch.
 Rotary servo motor series : HF-KP/HF-MP/HF-SP/HF-JP/HC-LP/HC-UP
 Linear servo motor series : LM-H2/LM-K2/LM-U2
 Direct drive motor series : TM-RFM
- Any combination of two servo motors of various series and/or capacity can be connected with MR-J3W-B servo amplifier.

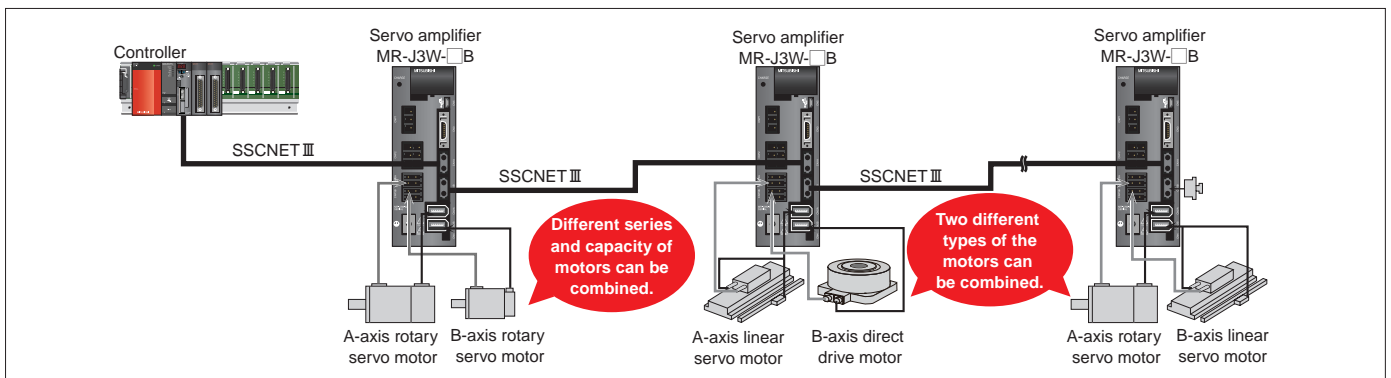

Servo Amplifier Model Designation

MR-J3W-B-

Mitsubishi general-purpose
AC servo amplifier
MELSERVO-J3W Series
(2-axis AC servo amplifier)

B: SSCNET III compatible

Symbol	Rated output (W)	
	A-axis	B-axis
22	200	200
44	400	400
77	750	750
1010	1k	1k

Symbol	Special specifications
ED	Without a dynamic brake (Note 1)

Notes: 1. Dynamic brake does not work at alarm occurrence or power failure. Take measures to ensure safety on the entire system.

* The servo amplifiers above conform to EN, UL and CSA standards.

●List of compatible rotary servo motor (Note 5)

Symbol	Axis	HF-KP	HF-MP	HF-SP	HF-JP (Note 1)	HC-LP	HC-UP
22	A/B	053, 13, 23	053, 13, 23	–	–	–	–
44	A/B	053 (Note 2, 3), 13 (Note 2, 3), 23, 43	053 (Note 2, 3), 13 (Note 2, 3), 23, 43	–	–	–	–
77	A/B	43 (Note 2, 3), 73	43 (Note 2, 3), 73	51 (Note 2, 3), 52 (Note 2, 3)	53 (Note 3), 73	52 (Note 2, 3)	72 (Note 2, 3)
1010	A/B	43 (Note 2, 3), 73	43 (Note 2, 3), 73	51, 81, 52, 102	53 (Note 4), 73, 103	52, 102	72

Notes: 1. The servo amplifier with software version B3 or above is compatible with this rotary servo motor.
2. When using the rotary servo motor with the servo amplifier with software version B2 or below, it is required to set parameter No. Po04 to "□□1□". For the servo amplifier with software version B3 or above, setting the parameter is not required.
3. When using FX3U-20SSC-H controller, a servo amplifier with software version B3 or above is required to use this rotary servo motor.
4. The maximum torque of HF-JP53 servo motor can be increased to 400% of the rated torque with this combination.
5. Refer to "Servo Motor Specifications" in this catalog for specifications of rotary servo motors.

●List of compatible linear servo motor (Note 3, 4)

Symbol	Axis	LM-H2		LM-K2		LM-U2	
		Primary side	Secondary side	Primary side	Secondary side	Primary side	Secondary side
22	A/B	–	–	–	–	PAB-05M-0SS0 PBB-07M-1SS0	SA0-□-0SS0 SB0-□-1SS0
44	A/B	P1A-06M-4SS0 P2A-12M-1SS0	S10-□-4SS0 S20-□-1SS0	P1A-01M-2SS1 (Note 1)	S10-□-2SS1 (Note 1)	PAB-05M-0SS0 PAD-10M-0SS0 PAF-15M-0SS0 PBB-07M-1SS0	SA0-□-0SS0 SB0-□-1SS0
77	A/B	P1A-06M-4SS0 (Note 2) P2A-12M-1SS0 (Note 2) P2B-24M-1SS0 P3A-24M-1SS0	S10-□-4SS0 (Note 2) S20-□-1SS0 (Note 2) S20-□-1SS0 S30-□-1SS0	P1A-01M-2SS1 (Note 1, 2) P2A-02M-1SS1 (Note 1)	S10-□-2SS1 (Note 1, 2) S20-□-1SS1 (Note 1)	PAD-10M-0SS0 (Note 2) PAF-15M-0SS0 (Note 2) PBD-15M-1SS0 PBF-22M-1SS0	SA0-□-0SS0 (Note 2) SB0-□-1SS0
1010	A/B	P1A-06M-4SS0 (Note 2) P2A-12M-1SS0 (Note 2) P2B-24M-1SS0 P3A-24M-1SS0	S10-□-4SS0 (Note 2) S20-□-1SS0 (Note 2) S20-□-1SS0 S30-□-1SS0	P1A-01M-2SS1 (Note 1, 2) P2A-02M-1SS1 (Note 1)	S10-□-2SS1 (Note 1, 2) S20-□-1SS1 (Note 1)	PAD-10M-0SS0 (Note 2) PAF-15M-0SS0 (Note 2) PBD-15M-1SS0 PBF-22M-1SS0	SA0-□-0SS0 (Note 2) SB0-□-1SS0

Notes: 1. The servo amplifier with software version B2 or above is compatible with this linear servo motor.
2. When using the linear servo motor with the servo amplifier with software version B2 or below, it is required to set parameter No. Po04 to "□□1□". For the servo amplifier with software version B3 or above, setting the parameter is not required.
3. The linear servo motor is not compatible with FX3U-20SSC-H controller.
4. Refer to "LINEAR SERVO LM Series catalog L(NA)03026" for specifications of linear servo motors.

●List of compatible direct drive motor (Note 1, 2, 3)

Symbol	Axis	TM-RFM
22	A/B	002C20
44	A/B	002C20, 004C20
77	A/B	004C20, 006C20, 006E20, 012E20, 012G20, 040J10
1010	A/B	004C20, 006C20, 006E20, 012E20, 018E20, 012G20, 040J10

Notes: 1. The servo amplifier with software version B3 or above is compatible with this direct drive motor.
2. The direct drive motor is not compatible with QD74MH and FX3U-20SSC-H controllers.
3. Refer to "Direct drive motor TM-RFM series catalog L(NA)03051ENG" for specifications of direct drive motors.

MELSERVO-J3W

MR-J3W-B Servo Amplifier Specifications

Servo amplifier model		MR-J3W-22B		MR-J3W-44B		MR-J3W-77B		MR-J3W-1010B	
Rated output capacity		A-axis 200W	B-axis 200W	A-axis 400W	B-axis 400W	A-axis 750W	B-axis 750W	A-axis 1kW	B-axis 1kW
Output	Rated voltage	3-phase 170VAC							
	Rated current (A)	1.5	1.5	2.8	2.8	5.8	5.8	6.0	6.0
Main circuit power supply (Note 10)	Voltage/frequency (Note 1, 2)	3-phase 200 to 230VAC 50/60Hz or 1-phase 200 to 230VAC 50/60Hz				3-phase 200 to 230VAC 50/60Hz or 1-phase 200 to 230VAC 50/60Hz (Note 11)		3-phase 200 to 230VAC 50/60Hz	
	Rated current (A)	3.5		6.1		10.4		13.9	
	Permissible voltage fluctuation	For 3-phase 200 to 230VAC: 3-phase 170 to 253VAC For 1-phase 200 to 230VAC: 1-phase 170 to 253VAC				For 3-phase 200 to 230VAC: 3-phase 170 to 253VAC For 1-phase 200 to 230VAC: 1-phase 170 to 253VAC (Note 11)		3-phase 170 to 253VAC	
	Permissible frequency fluctuation	±5% maximum							
Control circuit power supply	Voltage/frequency	1-phase 200 to 230VAC 50/60Hz							
	Rated current (A)	0.4							
	Permissible voltage fluctuation	1-phase 170 to 253VAC							
	Permissible frequency fluctuation	±5% maximum							
	Power consumption (W)	55							
Interface power supply		24VDC ±10% (required current capacity: 0.25A (Note 3))							
Capacitor regeneration	Reusable regenerative energy (Note 7) (J)	17		22		46			
	Rotary servo motor's or direct drive motor's moment of inertia equivalent to permissible charging amount (Note 8) J($\times 10^{-4}$ kg·m ²) [J (oz·in ²)]	3.45 (18.9)		4.46 (24.4)		9.32 (51.0)			
	Linear servo motor's mass equivalent to permissible charging amount (Note 9) (kg [lb])	8.5 (19)		11.0 (24.0)		23.0 (51.0)			
Tolerable regenerative power of regenerative resistor (W)	Built-in regenerative resistor	10				100			
Control system		Sine-wave PWM control/current control system							
Dynamic brake		Built-in (Note 4, 5)							
Safety features		Overcurrent shutdown, regeneration overvoltage shutdown, overload shutdown (electronic thermal), servo motor overheat protection, encoder fault protection, regeneration fault protection, undervoltage/sudden power outage protection, overspeed protection, excess error protection, magnetic pole detection protection, linear servo control fault protection							
Structure (IP rating)		Natural cooling open (IP00)				Fan cooling open (IP00)			
Environment	Ambient temperature (Note 6)	0 to 55°C (32 to 131°F) (non freezing), storage: -20 to 65°C (-4 to 149°F) (non freezing)							
	Ambient humidity	90% RH maximum (non condensing), storage: 90% RH maximum (non condensing)							
	Atmosphere	Indoors (no direct sunlight); no corrosive gas, inflammable gas, oil mist or dust							
	Elevation	1000m or less above sea level							
	Vibration	5.9m/s ² or less at 10 to 55Hz (directions of X, Y and Z axes)							
Mass (kg [lb])		1.4 (3.1)				2.3 (5.1)			

- Notes: 1. Rated output and speed of a rotary servo motor and direct drive motor; and rated thrust and speed of a linear servo motor are applicable when the servo amplifier, combined with the servo motors is operated within the specified power supply voltage and frequency. Torque and thrust drop when the power supply voltage is below the specified value.
2. For torque characteristics when combined with a rotary servo motor, refer to the section "Servo motor torque characteristics" in this catalog. For thrust characteristics when combined with a linear servo motor, refer to "LINEAR SERVO LM Series catalog L(NA)03026". For torque characteristics when combined with a direct drive motor, refer to "Direct drive motor TM-RFM series catalog L(NA)03051ENG".
3. 0.25A is the value when all of the input/output points are used. The current capacity can be stepped down according to the number of input/output points in use.
4. When using the built-in dynamic brake, refer to "MR-J3W-□B SERVO AMPLIFIER INSTRUCTION MANUAL" for permissible load to motor inertia moment ratio and load to motor mass ratio.
5. Special specification servo amplifiers without a dynamic brake are also available: MR-J3W-□B-ED. When using the servo amplifier without a dynamic brake, the servo motors do not stop immediately at alarm occurrence or power failure. Take measures to ensure safety on the entire system.
6. MR-J3W-□B servo amplifiers can be mounted closely. In the case of MR-J3-44B, however, operate them at 90% or less of the effective load ratio.
7. For rotary servo motors and direct drive motors, "regenerative energy" is the energy generated when a machine, which has a moment of inertia equivalent to the permissible charging amount, decelerates from the rated speed to a stop.
For linear servo motors, "regenerative energy" is the energy generated when a machine, which has mass equivalent to the permissible charging amount, decelerates from the maximum speed to a stop.
8. When two axes are simultaneously decelerated, the permissible charging amount is equivalent to the total moments of inertia of both axes. Otherwise, the permissible charging amount is equivalent to the moment of inertia of each axis.
9. Mass of primary side (coil) is included. When two axes are simultaneously decelerated, the permissible charging amount is equivalent to the total masses of both axes. Otherwise, the permissible charging amount is equivalent to the mass of each axis.
10. Refer to the following for power supply capacity.
• For rotary servo motor: "Servo Motor Specifications" in this catalog
• For linear servo motor: "LINEAR SERVO LM Series catalog L(NA)03026"
• For direct drive motor: "Direct drive motor TM-RFM series catalog L(NA)03051ENG-A".
Power supply capacity for this servo amplifier is equivalent to the total power supply capacities of each motor.
11. 1-phase 200 to 230VAC will be applicable for the servo amplifier manufactured in January 2011 or later.

MR-J3W-□B Standard Wiring Diagram

● Connection example

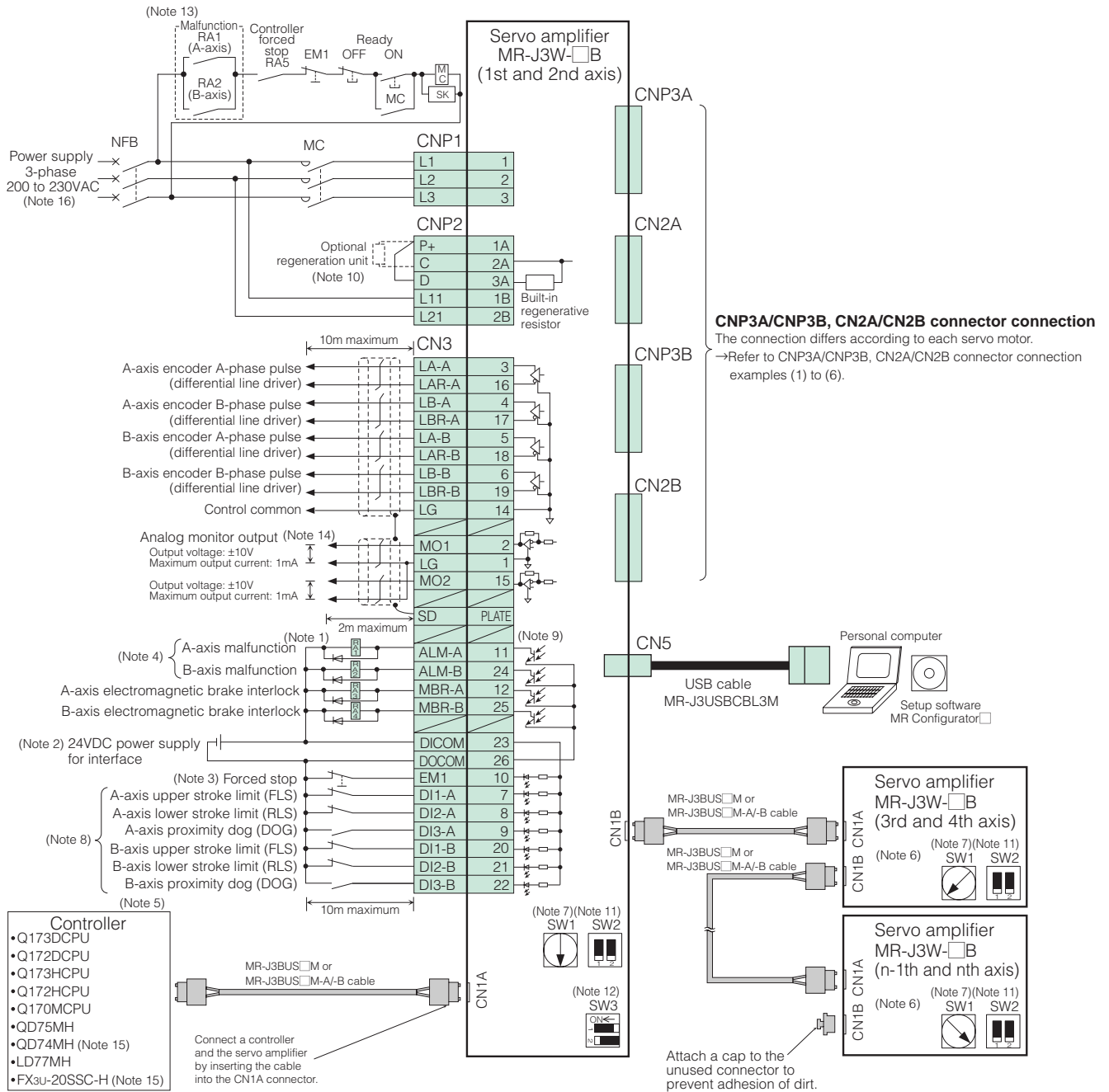

Notes:

- Do not reverse the diode's direction. Connecting it backwards may cause the servo amplifier to malfunction such that the signals are not output, and the forced stop and other safety circuits are inoperable.
- Use the power supply 24VDC±10% (required current capacity: 0.25A). 0.25A is the value when all of the input/output points are used. Note that the current capacity can be stepped down according to the number of input/output points in use. Refer to "MR-J3W-□B SERVO AMPLIFIER INSTRUCTION MANUAL" for details.
- The forced stop (EM1) signal is issued for both axes of the servo amplifier. For overall system, apply the emergency stop on the controller side.
- The malfunction (ALM-A/-B) signal (normally closed contact) is conducted to DOCOM in normal alarm-free condition.
- For details such as setting the controllers, refer to relevant controller's programming manual or user's manual.
- Connections for the third and following axes are omitted.
- Up to 16 axes (n=2 to 16) can be set using the axis selection rotary switch (SW1).
- Devices can be assigned for DI1, DI2 and DI3 with controller setting. Refer to the controller's instruction manuals for details on setting. These devices can be assigned with the controller: Q173DCPU, Q172DCPU, Q173HCPU, Q172HCPU, Q170MCP, QD75MH, QD74MH or LD77MH.
- This is for sink wiring. Source wiring is also possible. Refer to "MR-J3W-□B SERVO AMPLIFIER INSTRUCTION MANUAL" for details.
- When not using an optional regeneration unit, connect P+ and D to use the built-in regenerative resistor. When using an optional regeneration unit, disconnect P+ and D, and then connect the optional regeneration unit to P+ and C.
- Test operation select switch (SW2-1) is used to perform test operation mode with MR Configurator2 or MR Configurator. SW2-2 is for manufacturer setting.
- Servo motor select switch (SW3) is located on the bottom of the servo amplifier. SW3-1 is for A-axis and SW3-2 for B-axis. Select a servo motor as follows:
OFF: rotary servo motor, ON: linear servo motor or direct drive motor
- This connection is for continuing operation with one axis when an alarm occurs on the other axis. To stop the operation of the both axes with an alarm on one axis, connect RA1 and RA2 in series.
- Output voltage range varies depending on the monitored signal.
- Refer to "Servo Amplifier Model Designation ● Compatible servo motor list" in this catalog for servo motors compatible with QD74MH or FX3u-20SSC-H.
- When using a 1-phase 200VAC to 230VAC, connect the power supply to the L1 and L2 terminals. Do not connect anything to L3. Refer to "MR-J3W-B Servo Amplifier Specifications" in this catalog for the power supply.

Model designation

Servo motors

Servo amplifiers

Options

Peripheral equipment

MR-J3-B Safety

MR-J3W series

Servo support software

Cautions

Warranty

Global FA centers

MELSERVO-J3W

CNP3A/CNP3B and CN2A/CN2B Connectors Connection Examples

(1) HF-KP/HF-MP series

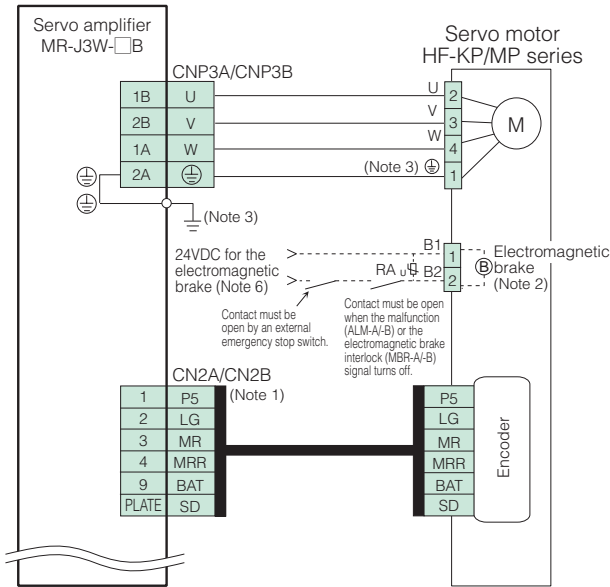

(2) HF-SP/HF-JP series

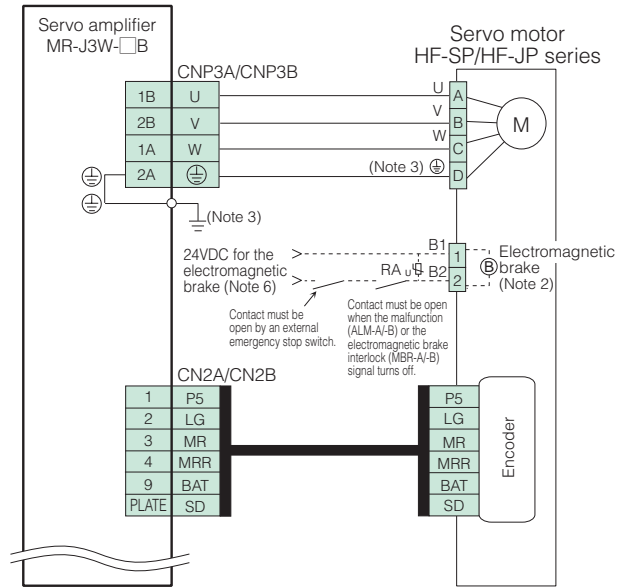

(3) HC-LP/HC-UP series

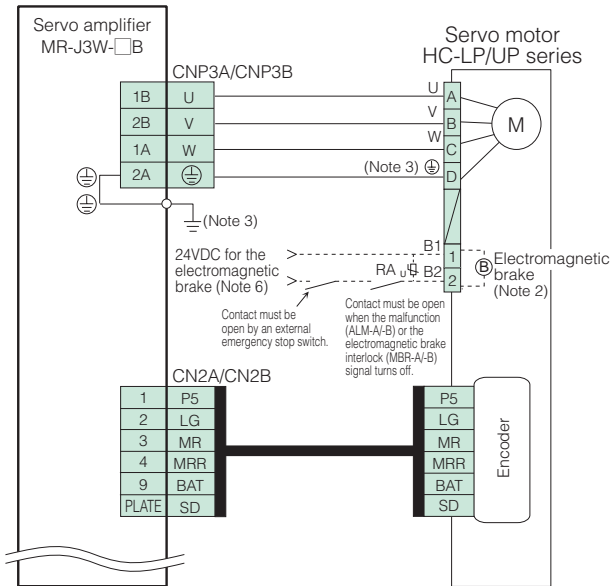

(4) LM-H2/LM-K2/LM-U2 series

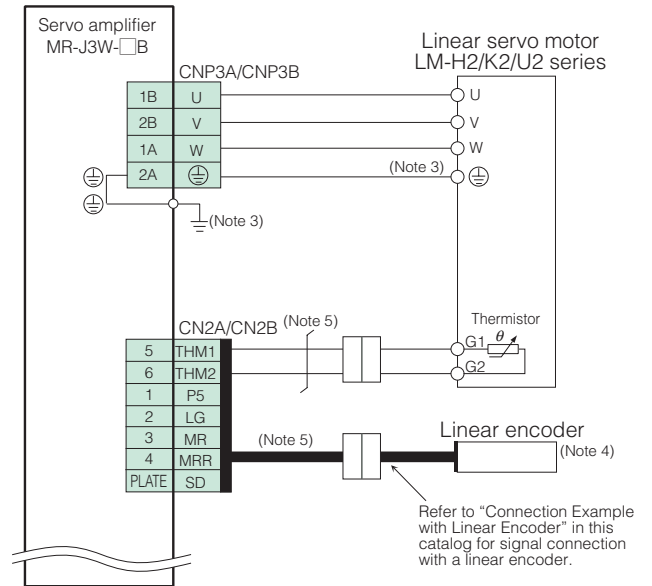

- Notes:
1. The signals shown is applicable when using a two-wire type encoder cable. When using a four-wire type encoder cable for HF-KP/HF-MP series, refer to "MR-J3W-□B SERVO AMPLIFIER INSTRUCTION MANUAL" for details.
 2. This is for the motor with an electromagnetic brake. The electromagnetic brake terminals (B1, B2) do not have polarity.
 3. Connect the ground wire to the cabinet protective earth (PE) terminal via the servo amplifier protective earth (PE) terminal for grounding.
 4. Refer to "Compatible Linear Encoder" for details on linear encoders.
 5. Manufacture these cables. The signal assignments shown is applicable when using a two-wire type encoder cable. Refer to "MR-J3W-□B SERVO AMPLIFIER INSTRUCTION MANUAL" for manufacturing the cables.
 6. Do not use the 24VDC interface power supply for the electromagnetic brake. Provide a power supply designed exclusively for the electromagnetic brake.

(5) TM-RFM series (incremental system)

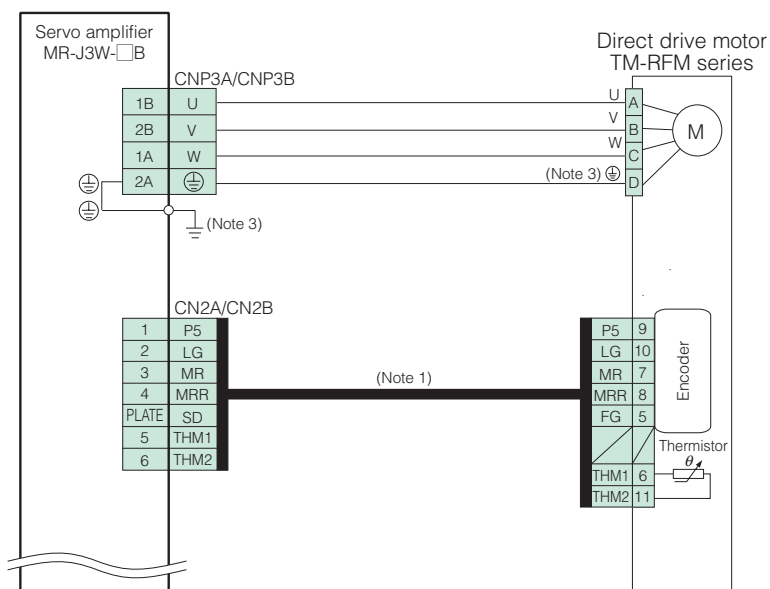

(6) TM-RFM series (absolute position detection system)

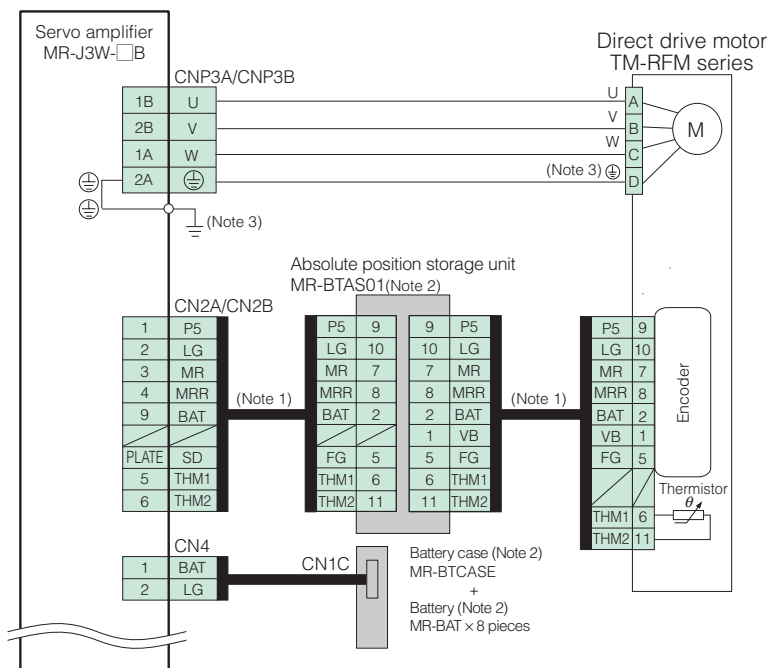

Notes:

1. Manufacture this cable. Refer to "MR-J3W-□B SERVO AMPLIFIER INSTRUCTION MANUAL" for manufacturing the encoder cable.
2. Optional MR-BTAS01 absolute position storage unit, MR-BTCASE battery case and MR-BAT batteries are required for absolute position detection system.
3. Connect the ground wire to the cabinet protective earth (PE) terminal via the servo amplifier protective earth (PE) terminal for grounding.

MELSERVO-J3W

Connection Examples with Linear Encoder (Note 1)

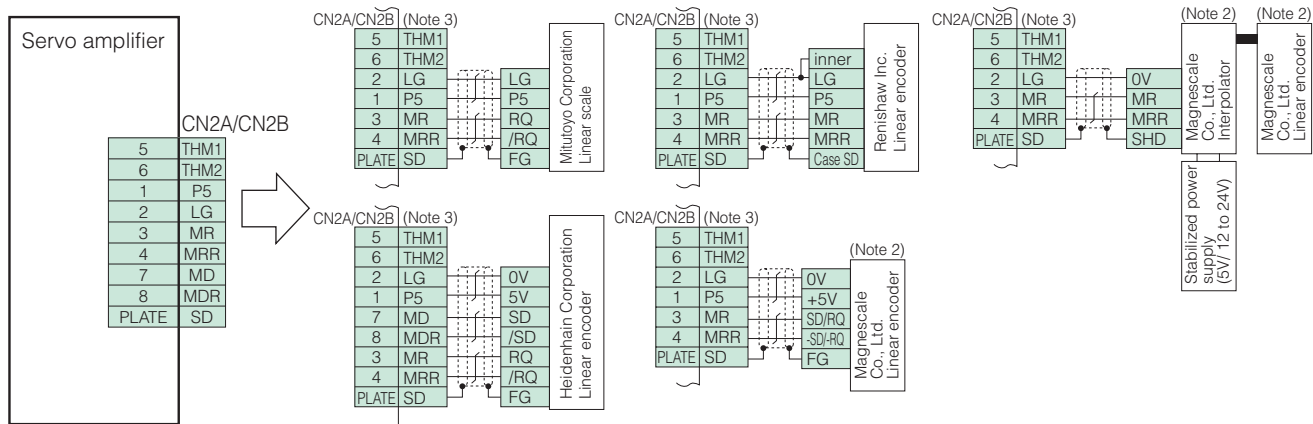

- Notes: 1. When manufacturing the linear encoder connection cable, use an optional CN2L connector (MR-J3CN2). Refer to "MR-J3W-□B SERVO AMPLIFIER INSTRUCTION MANUAL" for details on the wiring.
 2. Former company name: Sony Manufacturing System Corporation (changed since April 2010)
 3. For the number of the wire pairs for LG and P5, refer to "MR-J3W-□B SERVO AMPLIFIER INSTRUCTION MANUAL".

MR-J3W-□B Compatible Linear Encoders (Note 1, 2)

Linear encoder type	Manufacturer	Model (Note 11)	Resolution	Rated speed (Note 3)	Maximum effective measurement length (Note 6)	Communication method	Position detection system	
Mitsubishi serial interface compatible	Magnescale Co., Ltd. (Note 10)	SR77	0.05 μm / 0.01 μm	3.3m/s	2040mm	2-wire type	Absolute	
		SR87			3040mm			
	Mitutoyo Corporation	AT343A	0.05 μm	2.0m/s	3000mm	2-wire type		
		AT543A-SC			2200mm			
		AT545A-SC	20/4096 (μm) (Approx. 0.005 μm)	2.5m/s	2200mm			
		ST741A	0.5 μm	4.0m/s	6000mm			
		ST742A						
		ST743A						
	ST744A	0.1 μm						
	Heidenhain Corporation	LC 493M (Note 7)	0.05 μm / 0.01 μm	3.0m/s	2040mm	4-wire type		
		LC 193M (Note 8)			4240mm			
	Incremental type	Magnescale Co., Ltd. (Note 10)	SR75	0.05 μm / 0.01 μm	3.3m/s	2040mm		2-wire type
			SR85			3040mm		
		Renishaw Inc.	SL710+PL101-R/RH +MJ830 or MJ831 (Note 4)	0.2 μm (Note 5)	6.4m/s	100000mm		2-wire type
RGH26P			5 μm	4.0m/s	70000mm			
RGH26Q			1 μm	3.2m/s				
Heidenhain Corporation		RGH26R	0.5 μm	1.6m/s	4-wire type			
		LIDA 485+EIB 392M (Note 9)	20/16384 (μm) (Approx. 1.22nm)	4.0m/s		30040mm		
		LIDA 487+EIB 392M (Note 9)				6040mm		

- Notes: 1. Consult with the relevant linear encoder manufacturer for details on the linear encoder's working environment and specifications.
 2. The linear servo motor generates heat. Take the linear encoder's working environment temperature into consideration when configuring the system.
 3. The indicated values are the linear encoder's rated speed when used in combination with the MR-J3W-B servo amplifier. The values may differ from each manufacturer's specifications. The linear servo motor's maximum speed or the linear encoder's rated speed, whichever is smaller, is the upper limit value of the linear servo motor's speed.
 4. SH13 is out of production. Contact Magnescale Co., Ltd. for more details.
 5. The resolution varies according to the setting value of the interpolator, MJ830/MJ831 manufactured by Magnescale Co., Ltd. Set the resolution between the minimum resolution and 5 μm.
 6. The maximum length of Mitsubishi serial interface communication cable is 30m.
 7. LC 493M is a replacement for LC 491M. Contact Heidenhain Corporation for more details.
 8. LC 193M is a replacement for LC 192M. Contact Heidenhain Corporation for more details.
 9. EIB 392M is a replacement for APE 391M. Contact Heidenhain Corporation for more details.
 10. Former company name: Sony Manufacturing System Corporation (changed since April 2010)
 11. For servo amplifiers' software versions that are compatible with the linear encoders, refer to "List of Compatible Servo Amplifier Software Versions" in this catalog.

MR-J3W-□B Servo Amplifier Dimensions

(Unit: mm)

● MR-J3W-22B, MR-J3W-44B

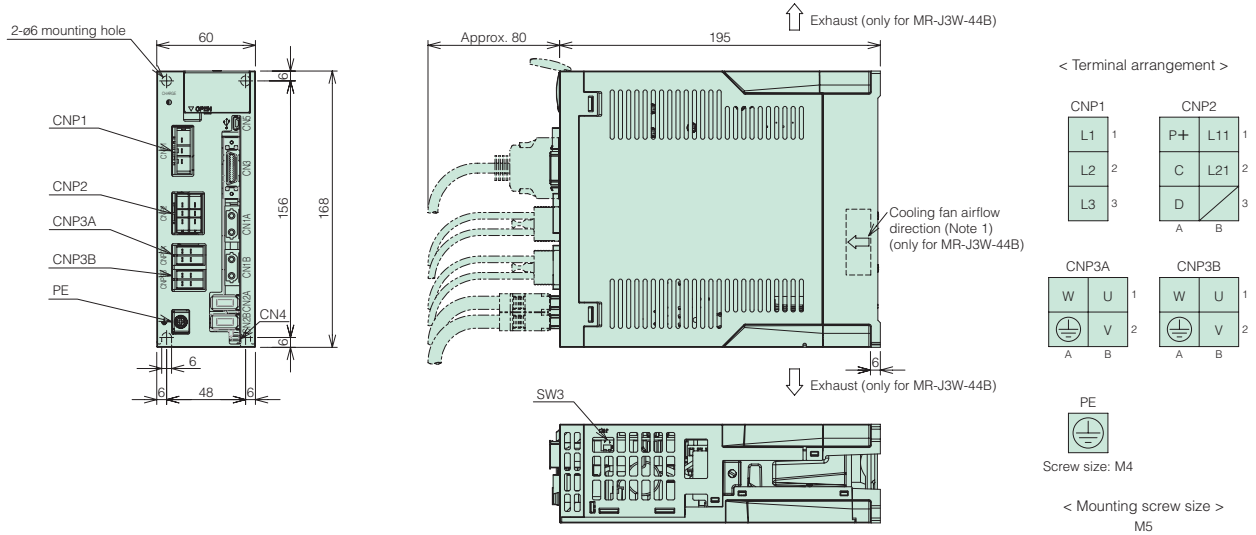

Notes: 1. Not necessary to open an air hole for the cooling fan on the cabinet.

● MR-J3W-77B, MR-J3W-1010B

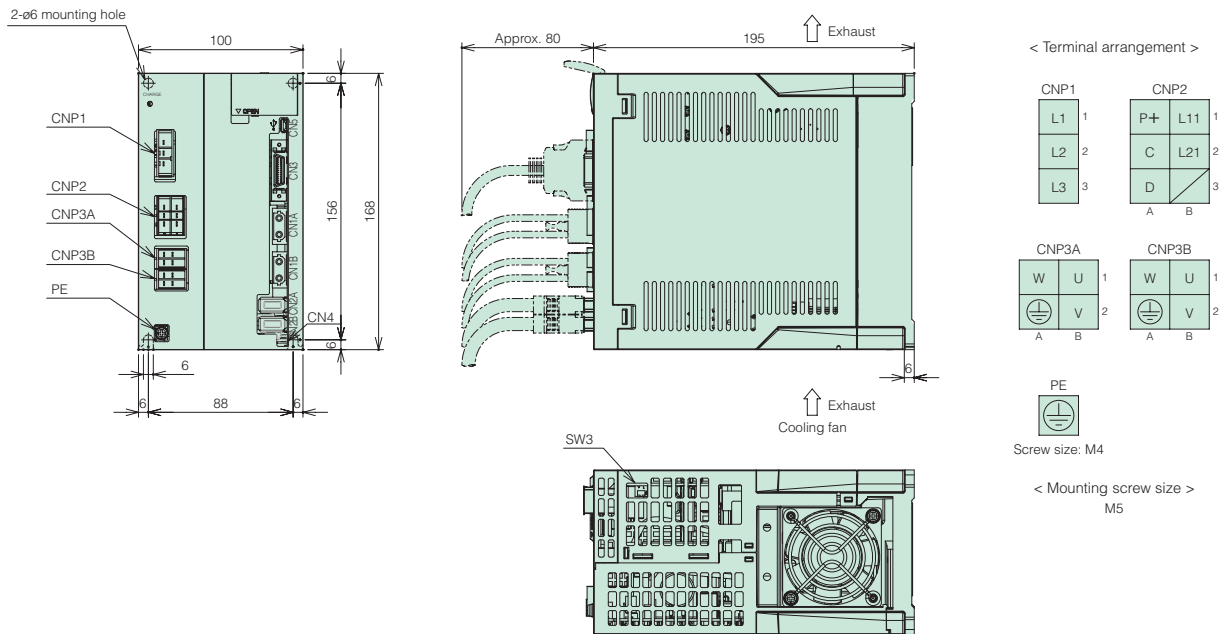

Model designation
Servo motors
Servo amplifiers
Options
Peripheral equipment
MR-J3-BSafety
MR-J3W series
Servo support software
Cautions
Warranty
Global FA centers

MR-J3W Basic Configurations

Necessary optional cables and connectors vary depending on the servo motor series.
Refer to the following tables for necessary options.

● Selecting options for servo amplifier

Servo amplifier		Reference
SSCNET III compatible	MR-J3W-□B	P.163 to 164 in this catalog

● Selecting options for servo motor

Use the cables in the following tables.

For the cable descriptions, refer to the relevant numbers in each list.

Capacity	Servo motor	Reference list		
		Encoder cable	Servo motor power supply cable	Electromagnetic brake cable (Note 1)
Rotary servo motor	HF-KP□(B)	Column A in encoder cable list	Column A in servo motor power supply cable list	Column A in electromagnetic brake cable list
	HF-MP□(B)	Column A in encoder cable list	Column A in servo motor power supply cable list	Column A in electromagnetic brake cable list
	HF-SP□(B)	Column B in encoder cable list	Column B in servo motor power supply cable list	Column B in electromagnetic brake cable list
	HF-JP□(B)			
	HC-LP□(B)	Column B in encoder cable list	Column C in servo motor power supply cable list	— (Note 2)
	HC-UP□(B)	Column B in encoder cable list	Column C in servo motor power supply cable list	— (Note 2)
Linear servo motor	LM-H2 series	Column C in encoder cable list	—	—
	LM-K2 series			
	LM-U2 series			
Direct drive motor	TM-RFM□C20	Column D in encoder cable list	Column D in servo motor power supply cable list	—
	TM-RFM□E20	Column D in encoder cable list	Column D in servo motor power supply cable list	—
	TM-RFM□G20	Column D in encoder cable list	Column E in servo motor power supply cable list	—
	TM-RFM□J10	Column D in encoder cable list	Column F in servo motor power supply cable list	—

Notes: 1. An electromagnetic cable is required only for servo motor with an electromagnetic brake.

2. An electromagnetic cable is not required for HC-LP52B/102B and HC-UP72B as the power supply connector has electromagnetic brake terminals.

● Encoder cable list

	Cable length	IP rating (Note 1)	Cable lead out direction	Bending life	Model	Reference	Note	
A	10m or shorter (Direct connection type)	IP65	Motor shaft side	Long bending life	MR-J3ENCBL□M-A1-H	① on P.168 in this catalog.	Select one from the list.	
				Standard	MR-J3ENCBL□M-A1-L			
			Opposite of motor shaft	Long bending life	MR-J3ENCBL□M-A2-H			② on P.168 in this catalog.
				Standard	MR-J3ENCBL□M-A2-L			
	Exceeding 10m (Relay type)	IP20	Motor shaft side	Long bending life	Two types of cables are required: MR-J3JCBL03M-A1-L and MR-EKCBL□M-H	③ and ⑤ on P.168 in this catalog.		
				Standard	Two types of cables are required: MR-J3JCBL03M-A1-L and MR-EKCBL□M-L			
			Opposite of motor shaft	Long bending life	Two types of cables are required: MR-J3JCBL03M-A2-L and MR-EKCBL□M-H			④ and ⑤ on P.168 in this catalog.
				Standard	Two types of cables are required: MR-J3JCBL03M-A2-L and MR-EKCBL□M-L			
		IP65	Motor shaft side	Long bending life	Two types of cables are required: MR-J3JSCBL03M-A1-L and MR-J3ENCBL□M-H	⑦ and ⑨ on P.168 in this catalog.		
				Standard	Two types of cables are required: MR-J3JSCBL03M-A1-L and MR-J3ENCBL□M-L			
			Opposite of motor shaft	Long bending life	Two types of cables are required: MR-J3JSCBL03M-A2-L and MR-J3ENCBL□M-H			⑧ and ⑨ on P.168 in this catalog.
				Standard	Two types of cables are required: MR-J3JSCBL03M-A2-L and MR-J3ENCBL□M-L			
B	2 to 50m 2 to 30m	IP67	—	Long bending life	MR-J3ENSCBL□M-H	⑨ on P.168 in this catalog.		
				Standard	MR-J3ENSCBL□M-L			
C	—	—	—	—	Manufacture a cable that fits to MR-J3THMCN2 (optional connector set).	⑳ on P.170 in this catalog.	—	
D	—	—	—	—	Manufacture a cable that fits to MR-J3DDCNS (optional connector set).	㉑ on P.170 in this catalog.	For connecting servo amplifier and direct drive motor, or servo amplifier and absolute position storage unit	
					Manufacture a cable that fits to MR-J3DDSPS (optional connector set).	㉒ on P.170 in this catalog.	For connecting absolute position storage unit and direct drive motor	

Notes: 1. The IP rating indicated is for the connector's protection against ingress of dust and water when coupled to a servo amplifier/servo motor. If the IP rating of the servo amplifier/servo motor differs from that of these connectors, overall IP rating depends on the lowest of all.

● Servo motor power supply cable list

	Cable length	IP rating (Note 1)	Cable lead out direction	Bending life	Model	Reference	Note
A	10m or shorter (Direct connection type)	IP65	Motor shaft side	Long bending life	MR-PWS1CBL□M-A1-H	⑫ on P.169 in this catalog.	Select one from the list.
				Standard	MR-PWS1CBL□M-A1-L		
	Opposite of motor shaft	Long bending life	MR-PWS1CBL□M-A2-H	⑬ on P.169 in this catalog.			
		Standard	MR-PWS1CBL□M-A2-L				
Exceeding 10m (Relay type)	IP55	Motor shaft side	Standard	Connect a user-manufactured cable to MR-PWS2CBL03M-A1-L (optional cable).		⑭ on P.169 in this catalog.	
				Connect a user-manufactured cable to MR-PWS2CBL03M-A2-L (optional cable).		⑮ on P.169 in this catalog.	

	IP rating (Note 1)	Servo motor	Model	Reference	Note
B	IP67	HF-SP series HF-JP series	Manufacture a cable that fits to MR-PWCNS4 (optional connector).	⑯ on P.169 in this catalog.	Select one that is compatible with the servo motor.
C	IP67	HC-LP series HC-UP series	Manufacture a cable that fits to MR-PWCNS1 (optional connector).	⑰ on P.169 in this catalog.	
D	IP67	TM-RFM□C20 TM-RFM□E20	Manufacture a cable that fits to MR-PWCNF (optional connector).	⑱ on P.170 in this catalog.	
E	IP67	TM-RFM□G20	Manufacture a cable that fits to MR-PWCNS4 (optional connector).	㉑ on P.170 in this catalog.	
F	IP67	TM-RFM□J10	Manufacture a cable that fits to MR-PWCNS5 (optional connector).	㉒ on P.170 in this catalog.	

● Electromagnetic brake cable list

	Cable length	IP rating (Note 1)	Cable lead out direction	Bending life	Model	Reference	Note
A	10m or shorter (Direct connection type)	IP65	Motor shaft side	Long bending life	MR-BKS1CBL□M-A1-H	⑲ on P.169 in this catalog.	Select one from the list.
				Standard	MR-BKS1CBL□M-A1-L		
	Opposite of motor shaft	Long bending life	MR-BKS1CBL□M-A2-H	⑳ on P.169 in this catalog.			
		Standard	MR-BKS1CBL□M-A2-L				
Exceeding 10m (Relay type)	IP55	Motor shaft side	Standard	Connect a user-manufactured cable to MR-BKS2CBL03M-A1-L (optional cable).		㉑ on P.169 in this catalog.	
				Connect a user-manufactured cable to MR-BKS2CBL03M-A2-L (optional cable).		㉒ on P.169 in this catalog.	

	IP rating (Note 1)	Servo motor	Model	Reference	Note
B	IP67	HF-SP series HF-JP series	Manufacture a cable that fits to MR-BKCNS1 (optional connector set) (straight type).	㉓ on P.169 in this catalog.	Select one that is compatible with the servo motor.
			Manufacture a cable that fits to MR-BKCNS1A (optional connector set) (angled type).	㉔ on P.169 in this catalog.	

Notes: 1. The IP rating indicated is for the connector's protection against ingress of dust and water when coupled to a servo amplifier/servo motor. If the IP rating of the servo amplifier/servo motor differs from that of these connectors, overall IP rating depends on the lowest of all.

MELSERVO-J3W

Options

● Cables and connectors for MR-J3W-B



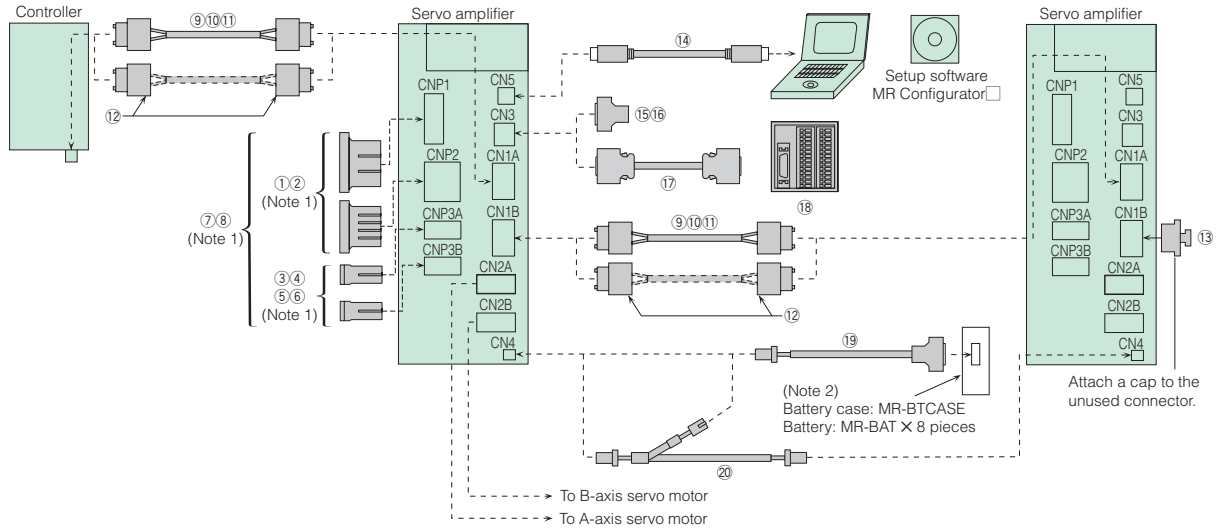



- Q173DCPU
- Q172DCPU
- Q173HCPU
- Q172HCPU
- Q170MCPUCPU
- QD75MH
- QD74MH
- LD77MH
- FX3u-20SSC-H



- Notes: 1. These connector sets are not included with the servo amplifier. Please purchase them separately.
 2. Battery case (MR-BTCASE) and batteries (MR-BAT) are not required when configuring absolute position detection system with linear servo motor.

Item		Model	IP rating	Description	
For CNP1 and CNP2	①	CNP1/CNP2 connector set (Qty: 1pc each)	—		
	②	CNP1/CNP2 connector set (Qty: 10pcs each)	—	CNP1 main circuit power supply connector set (JST Mfg.) J43FSS-03V-KX (receptacle housing) BJ4F-71GF-M3.0 (receptacle contact)	CNP2 control power supply connector set (JST Mfg.) F32FMS-06V-KXY (receptacle housing) BF3F-71GF-P2.0 (receptacle contact)
For CNP3A and CNP3B	③	CNP3A/CNP3B motor power supply connector set (Qty: 1pc) (for narrow wires)	—		<Applicable cable example> Wire size: 1.25mm ² (AWG19) to 1.25mm ² (AWG16)
	④	CNP3A/CNP3B motor power supply connector set (Qty: 20pc) (for narrow wires)	—	CNP3A/CNP3B motor power supply connector set (JST Mfg.) F35FDC-04V-K (receptacle housing) LF3F-41GF-P2.0 (receptacle contact)	Wire size: 1.25mm ² (AWG19) to 2.0mm ² (AWG14) Insulated outer diameter: φ1.8mm to φ2.8mm Crimping tool (YRF-880) is required.
	⑤	CNP3A/CNP3B motor power supply connector set (Qty: 1pc) (for thick wires)	—		Use this connector set for a junction cable of HF-KP/HF-MP servo motor series or for the following servo motors: HF-SP, HF-JP, HC-LP, HC-UP, LM-H2, LM-K2, LM-U2 and TM-RFM
	⑥	CNP3A/CNP3B motor power supply connector set (Qty: 20pc) (for thick wires)	—	CNP3A/CNP3B motor power supply connector set (JST Mfg.) F35FDC-04V-K (receptacle housing) BF3F-71GF-P2.0 (receptacle contact)	<Applicable cable example> Wire size: 1.25mm ² (AWG16) to 2.0mm ² (AWG14) Insulated outer diameter: φ2.4mm to φ3.3mm Crimping tool (YRF-1070) is required.
For CNP1, CNP2, CNP3A and CNP3B	⑦	MR-J3W-B power supply connector set (Set for 1 unit (for 2 axes))	—	These are included in one set for one unit. CNP1 main circuit power supply connector (1pc) (JST Mfg.) 03JFAT-SAGFK-43 Applicable wire size: 1.25mm ² (AWG16) to 2.0mm ² (AWG14)	 CNP2 control circuit power supply connector (1pc) (JST Mfg.) 06JFAT-SAXYGG-F-KK Applicable wire size: 1.25mm ² (AWG16) to 2.0mm ² (AWG14)
	⑧	MR-J3W-B power supply connector set (Set for 10 units (for 20 axes))	—	 CNP3A/CNP3B motor power supply connector (2pcs) (JST Mfg.) 04JFAT-SAGG-G-KK Applicable wire size: 0.75mm ² (AWG19) to 2.0mm ² (AWG14)	 Optional tool (1pc) (JST Mfg.) J-FAT-OT-EXL

● Cables and connectors for MR-J3W-B

Item		Model	IP rating	Description	
For controller, CN1A and CN1B	⑨ SSCNET III cable (Note 4) (Standard cord for inside cabinet)	MR-J3BUS□M □=cable length: 0.15, 0.3, 0.5, 1, 3m	—	Connector (Japan Aviation Electronics Industry) PF-2D103 (connector) Connector (Japan Aviation Electronics Industry) PF-2D103 (connector)	
	⑩ SSCNET III cable (Note 4) (Standard cable for outside cabinet)	MR-J3BUS□M-A □=cable length: 5, 10, 20m	—		
	⑪ SSCNET III cable (Note 4) (Long distance cable, long bending life)	MR-J3BUS□M-B □=cable length: 30, 40, 50m (Note 2)	—	Connector (Japan Aviation Electronics Industry) CF-2D103-S (connector) Connector (Japan Aviation Electronics Industry) CF-2D103-S (connector)	
	⑫ Connector set for SSCNET III (Note 4)	MR-J3BCN1 (Note 3)	—	 Connector (Japan Aviation Electronics Industry) PF-2D103 (connector) Connector (Japan Aviation Electronics Industry) PF-2D103 (connector)	
For CN1B	⑬ Connector cap for SSCNET III	(Standard accessory)	—		
For CN5	⑭ Personal computer communication cable	USB cable	MR-J3USBCBL3M Cable length: 3m	—	Amplifier connector mini-B connector (5 pins) Personal computer connector A connector  Note: This cable cannot be used with the SSCNET III compatible controller.
For CN3	⑮ Connector set (for CN3)	MR-J2CMP2 (Qty: 1pc)	—	 Amplifier connector (3M or an equivalent product) 10126-3000PE (connector) 10326-52F0-008 (shell kit)	
		MR-ECN1 (Qty: 20pcs)	—		
	⑰ Junction terminal block cable	MR-TBNATBL□M □=cable length: 0.5, 1m	—	Junction terminal block connector (3M or an equivalent product) 10126-6000EL (connector) 10326-3210-000 (shell kit) Amplifier connector (3M or an equivalent product) 10126-6000EL (connector) 10326-3210-000 (shell kit)	
	⑱ Junction terminal block	MR-TB26A	—		
For CN4	⑲ Battery connection cable	MR-J3BT1CBL□M □=cable length: 0.3, 1m	—	Amplifier connector (HIROSE ELECTRIC) DF3-2428SC(F)C (socket contact) DF3-2S-2C (socket) Battery case connector (3M or an equivalent product) 10120-3000PE (connector) 10320-52F0-008 (shell kit) (Note 1)	
	⑳ Battery connection relay cable (Note 5)	MR-J3BT2CBL□M □=cable length: 0.3, 1m	—	Junction connector (HIROSE ELECTRIC) DF3-EP2428PC(F)A (plug contact) DF3-2EP-2C (junction plug) Amplifier connector (HIROSE ELECTRIC) DF3-2428SC(F)C (socket contact) DF3-2S-2C (socket)	

- Notes: 1. The connector and the shell kit are of solder type. Models for press bonding type are 10120-6000EL (connector) and 10320-3210-000 (shell kit).
2. For the ultra-long bending life cables and/or for unlisted lengths which are 20m or shorter (available in the ultra-long bending life cables), contact Mitsubishi Electric System & Service Co., Ltd. FA PRODUCT DIVISION by email: oss-ip@melsc.jp
3. Special tools are required. Contact your local sales office for details.
4. Look carefully through the precautions enclosed with the options before use.
5. Up to 4 units (8 axes) of MR-J3W-□B servo amplifiers are connectable by using this cable. Refer to "MR-J3W-□B SERVO AMPLIFIER INSTRUCTION MANUAL" for more details.

Model designation
Servo motors
Servo amplifiers
Options
Peripheral equipment
MR-J3-BSafety
MR-J3W series
Servo support software
Cautions
Warranty
Global FA centers

MELSERVO-J3W

Options

● Cables and connectors for servo motor

For HF-KP/HF-MP servo motor series connecting with MR-J3W-B: encoder cable length 10m or shorter

- For leading the cables out in a direction of the motor shaft (Note 4)

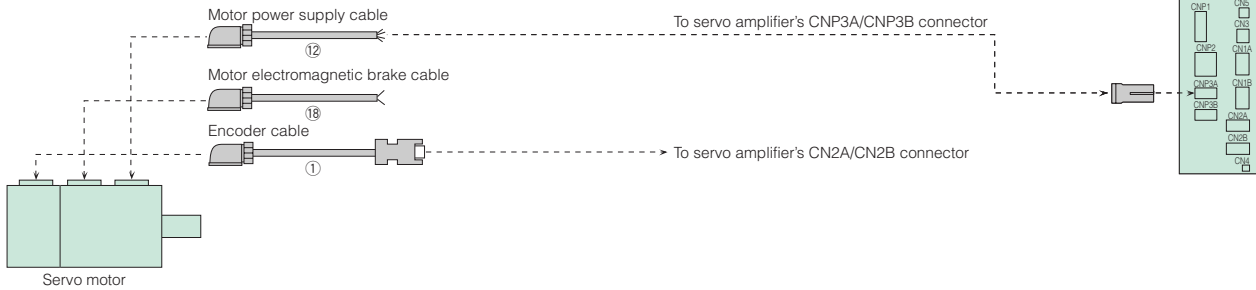

- For leading the cables out in an opposite direction of the motor shaft (Note 4)

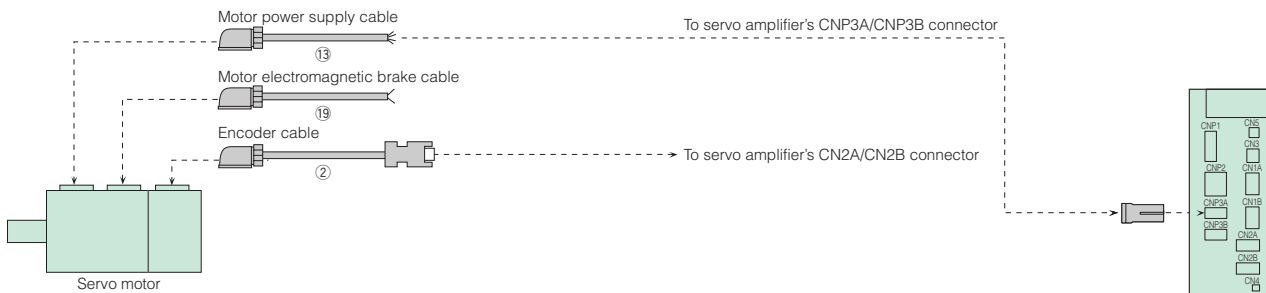

For HF-KP/HF-MP servo motor series connecting with MR-J3W-B: encoder cable length over 10m

- For leading the cables out in a direction of the motor shaft (Note 4)

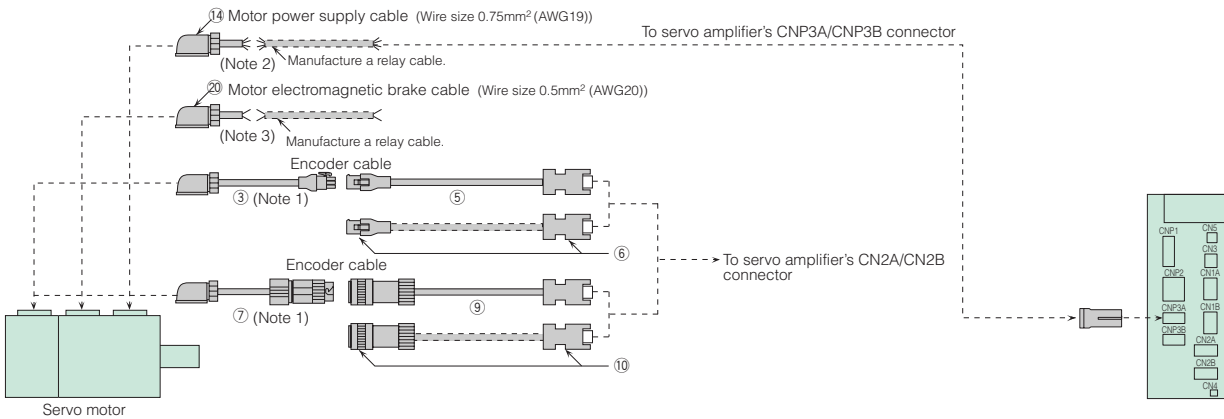

- For leading the cables out in an opposite direction of the motor shaft (Note 4)

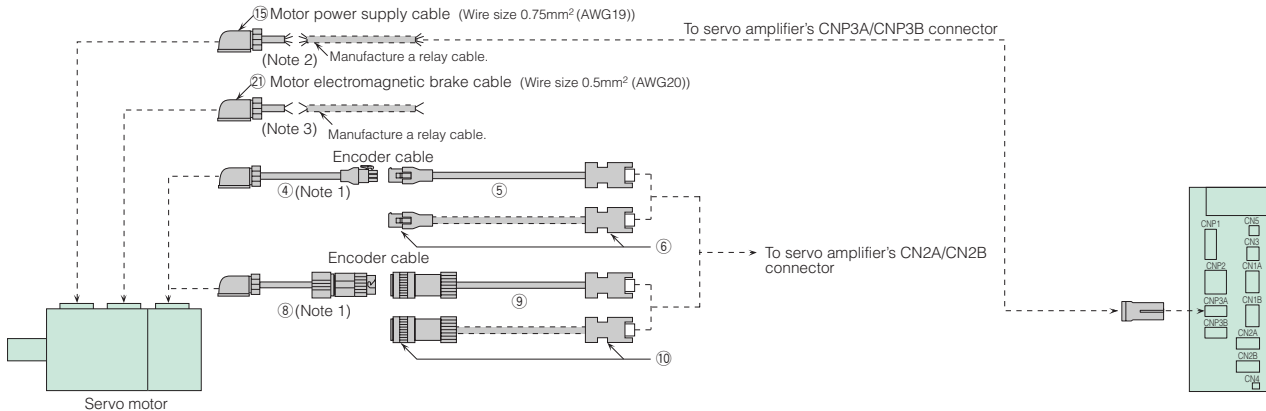

- Notes:
1. This cable does not have a long bending life, so always fix the cable before using.
 2. If the length exceeds 10m, relay a cable using MR-PWS2CBL03M-A1-L/-A2-L cable. This cable does not have a long bending life, so always fix the cable before using. Refer to "MR-J3W-□B SERVO AMPLIFIER INSTRUCTION MANUAL" for details on manufacturing the relay cable.
 3. If the length exceeds 10m, relay a cable using MR-BKS2CBL03M-A1-L/-A2-L cable. This cable does not have a long bending life, so always fix the cable before using. Refer to "MR-J3W-□B SERVO AMPLIFIER INSTRUCTION MANUAL" for details on manufacturing the relay cable.
 4. Cables for leading two different directions may be used for one servo motor.

For HF-SP servo motor series connecting with MR-J3W-B

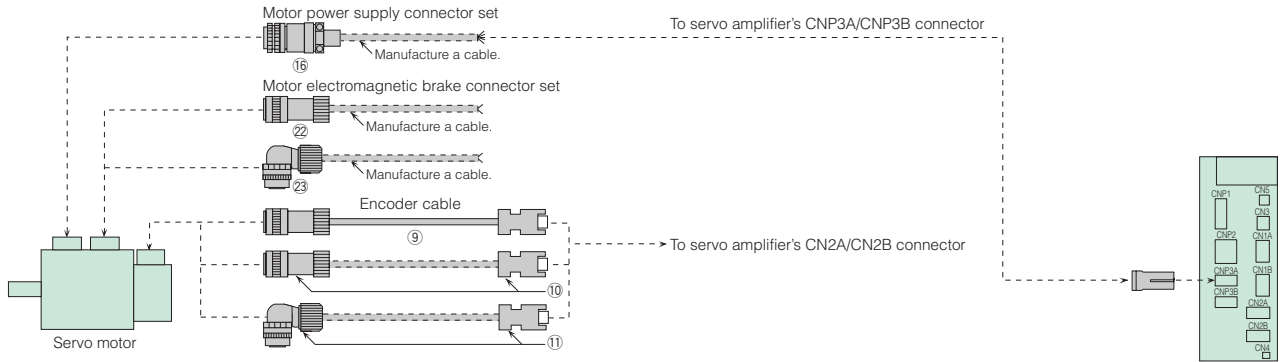

For HF-JP servo motor series connecting with MR-J3W-B

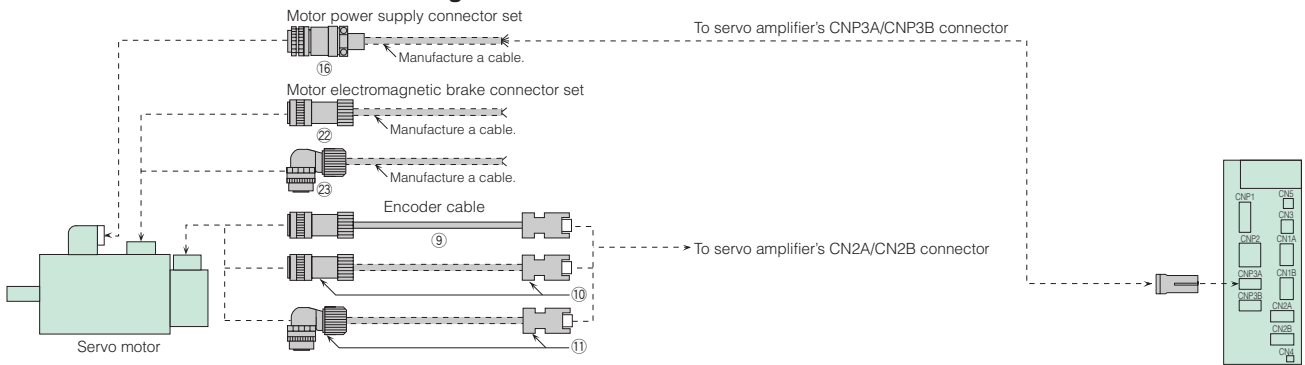

For HC-LP/HC-UP servo motor series connecting with MR-J3W-B

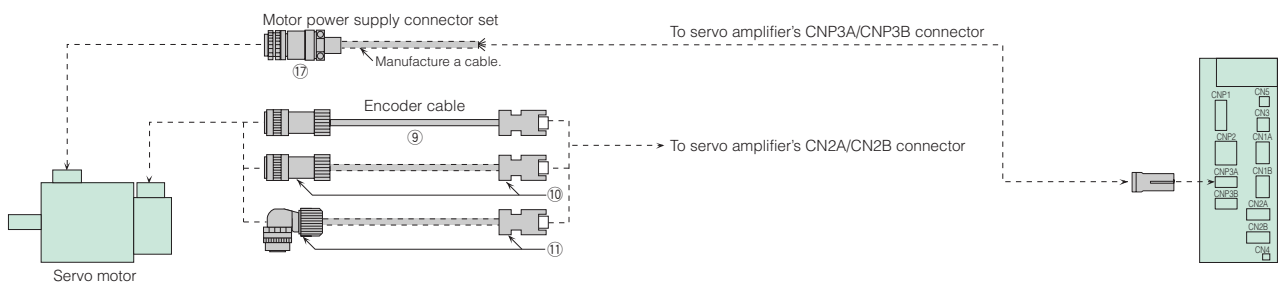

For LM-H2/LM-K2/LM-U2 linear servo motor series connecting with MR-J3W-B

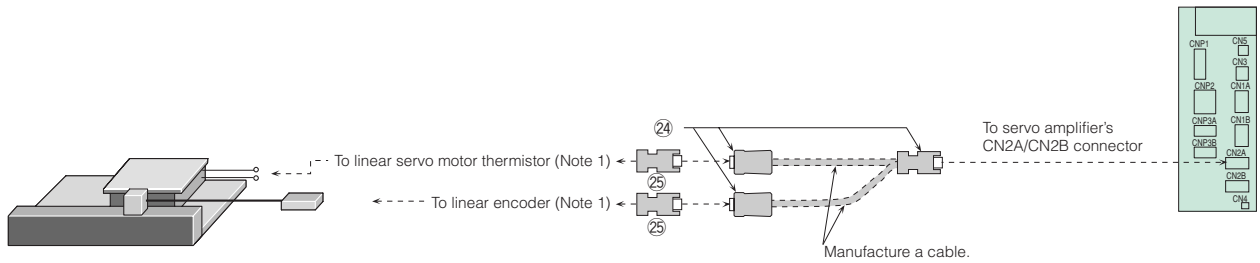

Notes: 1. Necessary options vary depending on a linear encoder. Refer to "MR-J3W-□B SERVO AMPLIFIER INSTRUCTION MANUAL" for details.

Model designation

Servo motors

Servo amplifiers

Options

Peripheral equipment

MR-J3-BSafety

MR-J3W series

Servo support software

Cautions

Warranty

Global FA centers

MELSERVO-J3W

Options

For TM-RFM direct drive motor series connecting with MR-J3W-B

- For incremental system

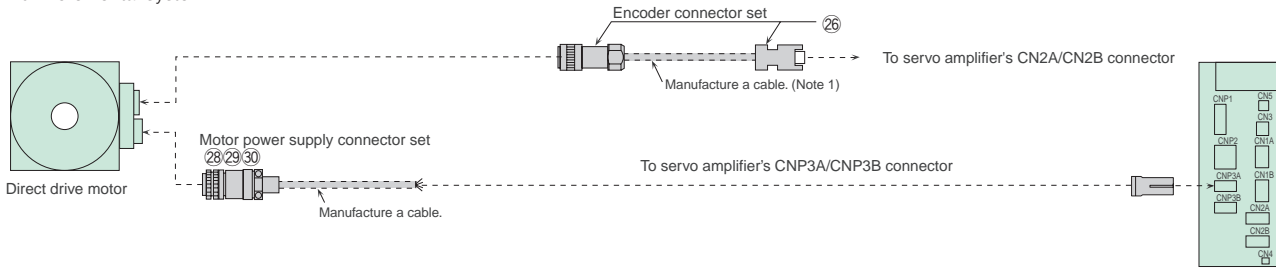



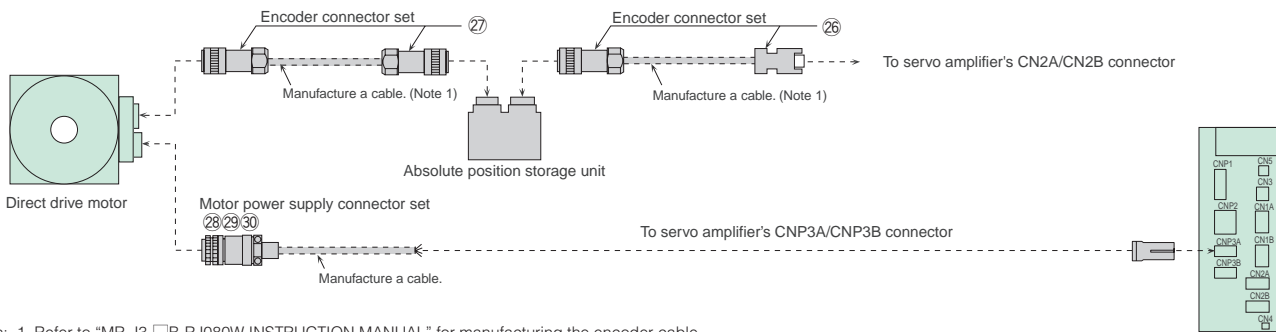



- For absolute position detection system



Notes: 1. Refer to "MR-J3-□B-RJ080W INSTRUCTION MANUAL" for manufacturing the encoder cable.

● Cables and connectors for servo motor connecting with MR-J3W-B







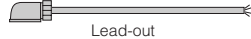

Item			Model	IP rating (Note 2)	Description	
For rotary servo motor encoder	①	10m or shorter (Direct connection type)	Encoder cable for HF-KP/HF-MP series Lead out in direction of motor shaft	MR-J3ENCBL□M-A1-H □=cable length: 2, 5, 10m (Note 1, 3)	IP65	 Encoder connector (Tyco Electronics) 1674320-1 Amplifier connector 36210-0100PL (receptacle, 3M) 36310-3200-008 (shell kit, 3M), or 54599-1019 (connector set, Molex)
			MR-J3ENCBL□M-A1-L □=cable length: 2, 5, 10m (Note 1)	IP65		
	②	Encoder cable for HF-KP/HF-MP series Lead out in opposite direction of motor shaft	MR-J3ENCBL□M-A2-H □=cable length: 2, 5, 10m (Note 1, 3)	IP65		
			MR-J3ENCBL□M-A2-L □=cable length: 2, 5, 10m (Note 1)	IP65		
	③	Exceeding 10m (Relay type)	Motor-side encoder cable for HF-KP/HF-MP series Lead out in direction of motor shaft	MR-J3JCBL03M-A1-L Cable length: 0.3m (Note 1)	IP20	 Encoder connector (Tyco Electronics) 1674320-1 Junction connector (Tyco Electronics) 1473226-1 (with ring) (contact) 1-172169-9 (housing) 316454-1 (cable clamp)
	④		Motor-side encoder cable for HF-KP/HF-MP series Lead out in opposite direction of motor shaft	MR-J3JCBL03M-A2-L Cable length: 0.3m (Note 1)	IP20	
	⑤	Exceeding 10m (Relay type)	Amplifier-side encoder cable for HF-KP/HF-MP series	MR-EKCBL□M-H □=cable length: 20, 30, 40, 50m (Note 1, 3, 6)	IP20	 Junction connector (Tyco Electronics) 1-172161-9 (housing) 170359-1 (connector pin) MTI-0002 (cable clamp, TOA ELECTRIC INDUSTRIAL) Amplifier connector 36210-0100PL (receptacle, 3M) 36310-3200-008 (shell kit, 3M), or 54599-1019 (connector set, Molex)
				MR-EKCBL□M-L □=cable length: 20, 30m (Note 1, 6)	IP20	
	⑥	Exceeding 10m (Relay type)	Junction connector set for HF-KP/HF-MP series	MR-ECNM	IP20	 Junction connector (Tyco Electronics) 1-172161-9 (housing) 170359-1 (connector pin) MTI-0002 (cable clamp, TOA ELECTRIC INDUSTRIAL) Amplifier connector 36210-0100PL (receptacle, 3M) 36310-3200-008 (shell kit, 3M), or 54599-1019 (connector set, Molex)
	⑦		Motor-side encoder cable for HF-KP/HF-MP series Lead out in direction of motor shaft	MR-J3JSCBL03M-A1-L Cable length: 0.3m (Note 1)	IP65 (Note 5)	<Applicable cable example> Wire size: 0.3mm ² (AWG22) Completed cable outer diameter: φ8.2mm Crimping tool (91529-1) is required. Use these in combination of ③ or ④.
	⑧	Exceeding 10m (Relay type)	Motor-side encoder cable for HF-KP/HF-MP series Lead out in opposite direction of motor shaft	MR-J3JSCBL03M-A2-L Cable length: 0.3m (Note 1)	IP65 (Note 5)	 Encoder connector (Tyco Electronics) 1674320-1 Junction connector (DDK) CM10-CR10P-M (cable receptacle)
⑨	Encoder cable for HF-KP/HF-MP/HF-SP/HF-JP/HF-LP/HF-UP series		MR-J3ENCBL□M-H □=cable length: 2, 5, 10, 20, 30, 40, 50m (Note 1, 3, 4)	IP67	Use these in combination of ⑦ or ⑧ for HF-KP/HF-MP series.	
⑩	Exceeding 10m (Relay type)	Encoder connector set for HF-KP/HF-MP/HF-SP/HF-JP/HF-LP/HF-UP series	MR-J3ENCBL□M-L □=cable length: 2, 5, 10, 20, 30m (Note 1, 4)	IP67	 Amplifier connector 36210-0100PL (receptacle, 3M) 36310-3200-008 (shell kit, 3M), or 54599-1019 (connector set, Molex)	
			MR-J3SCNS (Note 4)	IP67	Encoder connector (DDK) CM10-SP10S-M (D6) (straight plug) CM10-#22SC(S1) (D8)-100 (socket contact) <Applicable cable example> Wire size: 0.5mm ² (AWG20) or smaller Completed cable outer diameter: φ6.0mm to φ9.0mm Use these in combination of ⑦ or ⑧ for HF-KP/HF-MP series.	
⑪	Exceeding 10m (Relay type)	Encoder connector set for HF-SP/HF-JP/HF-LP/HF-UP series	MR-J3SCNSA (Note 4)	IP67	 Amplifier connector 36210-0100PL (receptacle, 3M) 36310-3200-008 (shell kit, 3M), or 54599-1019 (connector set, Molex)	
			MR-J3SCNSA (Note 4)	IP67	Encoder connector (DDK) CM10-AP10S-M(D6) (angled plug) CM10-#22SC(S1)(D8)-100 (socket contact) <Applicable cable example> Wire size: 0.5mm ² (AWG20) or smaller Completed cable outer diameter: φ6.0mm to φ9.0mm	

- Notes: 1. -H and -L indicate a bending life. -H indicates a long bending life, and -L indicates a standard bending life.
 2. The IP rating indicated is for the connector's protection against ingress of dust and water when coupled to a servo amplifier/servo motor. If the IP rating of the servo amplifier/servo motor differs from that of these connectors, overall IP rating depends on the lowest of all.
 3. For the ultra-long bending life cables and/or for unlisted lengths (available in the ultra-long bending life cables), contact Mitsubishi Electric System & Service Co., Ltd. FA PRODUCT DIVISION by email: oss-ip@melsc.jp
 4. Select from below if there is a potential risk that a high vibration may be applied to connectors.
 Encoder cable: MR-J3ENCBL□M-H-S06 (long bending life) or MR-J3ENCBL□M-L-S06 (standard bending life)
 Encoder connector set: MR-J3SCNS-S06 (straight type) or MR-J3SCNSA-S06 (angled type)
 Connector cover: MR-J3ENS-CVR (straight type) or MR-J3ENSA-CVR (angled type)
 Be sure to use this connector cover when using the encoder cable or the encoder connector set in the table.
 Contact your local sales office for more details.
 5. The encoder cable is rated IP65 while the junction connector is rated IP67.
 6. □ are available in 4-wire type. Parameter setting is required to use the 4-wire type encoder cable. Refer to "MR-J3W-□B SERVO AMPLIFIER INSTRUCTION MANUAL" for more details.

MELSERVO-J3W







Options

● Cables and connectors for servo motor connecting with MR-J3W-B

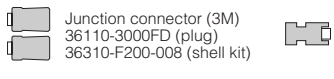
Item			Model	IP rating (Note 2)	Description		
For rotary servo motor power supply	⑫	10m or shorter (Direct connection type)	Power supply cable for HF-KP/HF-MP series Lead out in direction of motor shaft	MR-PWS1CBL□M-A1-H □=cable length: 2, 5, 10m (Note 1, 3)	IP65	 Lead-out *The cable is not shielded.	
			MR-PWS1CBL□M-A1-L □=cable length: 2, 5, 10m (Note 1)	IP65			
	⑬	Power supply cable for HF-KP/HF-MP series Lead out in opposite direction of motor shaft	MR-PWS1CBL□M-A2-H □=cable length: 2, 5, 10m (Note 1, 3)	IP65			
			MR-PWS1CBL□M-A2-L □=cable length: 2, 5, 10m (Note 1)	IP65			
	⑭	Exceeding 10m (Relay type)	Power supply cable for HF-KP/HF-MP series Lead out in direction of motor shaft	MR-PWS2CBL03M-A1-L Cable length: 0.3m (Note 1)	IP55		 Lead-out *The cable is not shielded.
	⑮		Power supply cable for HF-KP/HF-MP series Lead out in opposite direction of motor shaft	MR-PWS2CBL03M-A2-L Cable length: 0.3m (Note 1)	IP55		
	⑯	Power supply connector set for HF-SP/HF-JP series		MR-PWCNS4 (Straight type)	IP67		 Motor power supply connector (DDK) CE05-6A18-10SD-D-BSS (plug) (straight) CE3057-10A-1-D (cable clamp) <Applicable cable example> Wire size: 2mm ² (AWG14) to 3.5mm ² (AWG12) Completed cable outer diameter: φ10.5mm to φ14.1mm
Power supply connector set for HC-LP/HC-UP series		MR-PWCNS1 (Straight type)	IP67	 Motor power supply connector (DDK) CE05-6A22-23SD-D-BSS (plug) (straight) CE3057-12A-2-D (cable clamp) <Applicable cable example> Wire size: 2mm ² (AWG14) to 3.5mm ² (AWG12) Completed cable outer diameter: φ9.5mm to φ13mm			
For rotary servo motor electromagnetic brake	⑰	10m or shorter (Direct connection type)	Brake cable for HF-KP/HF-MP series Lead out in direction of motor shaft	MR-BKS1CBL□M-A1-H □=cable length: 2, 5, 10m (Note 1, 3)	IP65	 Lead-out *The cable is not shielded.	
			MR-BKS1CBL□M-A1-L □=cable length: 2, 5, 10m (Note 1)	IP65			
	⑱	Brake cable for HF-KP/HF-MP series Lead out in opposite direction of motor shaft	MR-BKS1CBL□M-A2-H □=cable length: 2, 5, 10m (Note 1, 3)	IP65			
			MR-BKS1CBL□M-A2-L □=cable length: 2, 5, 10m (Note 1)	IP65			
	⑳	Exceeding 10m (Relay type)	Brake cable for HF-KP/HF-MP series Lead out in direction of motor shaft	MR-BKS2CBL03M-A1-L Cable length: 0.3m (Note 1)	IP55		 Lead-out *The cable is not shielded.
	㉑		Brake cable for HF-KP/HF-MP series Lead out in opposite direction of motor shaft	MR-BKS2CBL03M-A2-L Cable length: 0.3m (Note 1)	IP55		
	㉒	Brake connector set for HF-SP/HF-JP series		MR-BKCNS1 (Note 4) (Straight type)	IP67		 Motor brake connector (DDK) (solder type) CM10-SP2S-L(D6)(straight plug) CM10-#22SC(S2)(D8)-100 (socket contact) <Applicable cable example> Wire size: 1.25mm ² (AWG16) or smaller Completed cable outer diameter: φ9.0mm to φ11.6mm
㉓	Brake connector set for HF-SP/HF-JP series		MR-BKCNS1A (Note 4) (Angled type)	IP67	 Motor brake connector (DDK) (solder type) CM10-AP2S-L(D6) (angled plug) CM10-#22SC(S2)(D8)-100 (socket contact) <Applicable cable example> Wire size: 1.25mm ² (AWG16) or smaller Completed cable outer diameter: φ9.0mm to φ11.6mm		

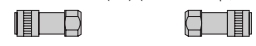
- Notes: 1. -H and -L indicate a bending life. -H indicates a long bending life, and -L indicates a standard bending life.
 2. The IP rating indicated is for the connector's protection against ingress of dust and water when coupled to a servo amplifier/servo motor. If the IP rating of the servo amplifier/servo motor differs from that of these connectors, overall IP rating depends on the lowest of all.
 3. For the ultra-long bending life cables and/or for unlisted lengths (available in the ultra-long bending life cables), contact Mitsubishi Electric System & Service Co., Ltd. FA PRODUCT DIVISION by email: oss-ip@melsec.jp
 4. Select from below if there is a potential risk that a high vibration may be applied to connectors.
 Brake connector set: MR-BKCNS1-S06 (straight type) or MR-BKCNS1A-S06 (angled type)
 Connector cover: MR-J3ENS-CVR (straight type) or MR-J3ENSA-CVR (angled type)
 Be sure to use this connector cover when using the brake connector set in the table.
 Contact your local sales office for more details.

● Cables and connectors for servo motor connecting with MR-J3W-B

Item		Model	IP rating (Note 1)	Description
For linear servo motor	②4	Connector set (for linear encoder and thermistor)	MR-J3THMCN2	—  Junction connector (3M) 36110-3000FD (plug) 36310-F200-008 (shell kit) Amplifier connector 36210-0100PL (receptacle, 3M), 36310-3200-008 (shell kit, 3M) or 54599-1019 (connector set, Molex)
	②5	Connector set (for linear encoder and thermistor connection)	MR-J3CN2	—  Linear encoder and thermistor connection connector 36210-0100PL (receptacle, 3M), 36310-3200-008 (shell kit, 3M) or 54599-1019 (connector set, Molex)
For direct drive motor encoder	②6	Encoder connector set (for connecting servo amplifier and direct drive motor, or for servo amplifier and absolute position storage unit)	MR-J3DDCNS	IP67  Amplifier connector 36210-0100PL (receptacle, 3M) 36310-3200-008 (shell kit, 3M), or 54599-1019 (connector set, Molex) Encoder connector or absolute position storage unit connector RM15WTPZK-12S (plug, HIROSE ELECTRIC) JR13WCCA-8(72) (code clamp, HIROSE ELECTRIC) <Applicable cable example> Wire size: 0.25mm ² (AWG23) to 0.5mm ² (AWG20) Completed cable outer diameter: φ7.8mm to φ8.2mm
	②7	Encoder connector set (for connecting absolute position storage unit and direct drive motor)	MR-J3DDSPS	IP67  Absolute position storage unit connector RM15WTPZ-12P(72) (plug, HIROSE ELECTRIC) JR13WCCA-8(72) (code clamp, HIROSE ELECTRIC) Encoder connector RM15WTPZK-12S (plug, HIROSE ELECTRIC) JR13WCCA-8(72) (code clamp, HIROSE ELECTRIC) <Applicable cable example> Wire size: 0.25mm ² (AWG23) to 0.5mm ² (AWG20) Completed cable outer diameter: φ7.8mm to φ8.2mm
For direct drive motor power supply	②8	Power supply connector set for TM-RFM□C20, TM-RFM□E20	MR-PWCNF (Straight type)	IP67  Motor power supply connector (DDK) CE05-6A14S-2SD-D (plug) (straight) YSO14-9 to 11 (cable clamp, Daiwa Dengyo) <Applicable cable example> Wire size: 0.3mm ² (AWG22) to 1.25mm ² (AWG16) Completed cable outer diameter: φ8.3mm to φ11.3mm
	②9	Power supply connector set for TM-RFM□G20	MR-PWCNS4 (Straight type)	IP67  Motor power supply connector (DDK) CE05-6A18-10SD-D-BSS (plug) (straight) CE3057-10A-1-D (cable clamp) <Applicable cable example> Wire size: 2mm ² (AWG14) to 3.5mm ² (AWG12) Completed cable outer diameter: φ10.5mm to φ14.1mm
	③0	Power supply connector set for TM-RFM□J10	MR-PWCNS5 (Straight type)	IP67  Motor power supply connector (DDK) CE05-6A22-22SD-D-BSS (plug) (straight) CE3057-12A-1-D (cable clamp) <Applicable cable example> Wire size: 5.5mm ² (AWG10) to 8mm ² (AWG8) Completed cable outer diameter: φ12.5mm to φ16mm

Notes: 1. The IP rating indicated is for the connector's protection against ingress of dust and water when coupled to a servo amplifier/direct drive motor. If the IP rating of the servo amplifier/direct drive motor differs from that of these connectors, overall IP rating depends on the lowest of all.

Model designation
Servo motors
Servo amplifiers
Options
Peripheral equipment
MR-J3-BSafety
MR-J3W series
Servo support software
Cautions
Warranty
Global FA centers

MELSERVO-J3W

Ordering Information for Customers

To order the following products, contact the relevant manufacturers directly.

Refer to "Ordering Information for Customers" for MELSERVO-J3 series in this catalog for encoder, power supply and electromagnetic brake connectors for the rotary servo motors. For connectors for the linear servo motor and the direct drive motor, refer to the relevant catalogs.

● Main circuit power supply cable (for CNP1)

Model	Description	Wire size
SC-EMP01CBL□M-L □ = cable length: 2, 5m (Note 2, 3)	 Terminal processing type: cut Mitsubishi Electric System & Service Co., Ltd. (Note 1)	AWG14

● Control circuit power supply cable (for CNP2-B(Y))

Model	Description	Wire size
SC-ECP01CBL□M-L □ = cable length: 2, 5m (Note 2, 3)	 Terminal processing type: cut Mitsubishi Electric System & Service Co., Ltd. (Note 1)	AWG16

● Built-in regenerative resistor short-circuit connector (for CNP2-A(X))

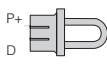
Model	Description	Wire size
SC-ERG02CBL01M-L	 Mitsubishi Electric System & Service Co., Ltd. (Note 1)	AWG14

● Optional regeneration unit cable (for CNP2-A(X))

Model	Description	Wire size
SC-ERG01CBL□M-L □ = cable length: 2, 5m (Note 2, 3)	 Terminal processing type: cut Mitsubishi Electric System & Service Co., Ltd. (Note 1)	AWG14

● Power supply cable for HF-KP/HF-MP rotary servo motor series (direct connection type)

Model	Description	Wire size
SC-EPWS1CBL□M-A1-L □ = cable length: 2, 5, 10m (Note 2, 3)	Lead out in direction of motor shaft Standard bending life	AWG18 × 4C
SC-EPWS1CBL□M-A2-L □ = cable length: 2, 5, 10m (Note 2, 3)	Lead out in opposite direction of motor shaft Standard bending life	
SC-EPWS1CBL□M-A1-H □ = cable length: 2, 5, 10m (Note 2, 3)	Lead out in direction of motor shaft Long bending life	AWG19 × 4C
SC-EPWS1CBL□M-A2-H □ = cable length: 2, 5, 10m (Note 2, 3)	Lead out in opposite direction of motor shaft Long bending life	

● Power supply cable for HF-KP/HF-MP rotary servo motor series (junction type)

● Power supply cable for HF-SP/HF-JP/HC-LP/HC-UP rotary servo motor series (Note 4)

● Power supply cable for LM-H2/LM-K2/LM-U2 linear servo motor series

● Power supply cable for TM-RFM direct drive motor series

Model	Description	Wire size
SC-EPWS2CBL□M-L □ = cable length: 2, 5, 10, 20, 30m (Note 2, 3)	Standard bending life	AWG18 × 4C (2, 5, 10m)
SC-EPWS2CBL□M-H □ = cable length: 2, 5, 10, 20, 30m (Note 2, 3)	Long bending life	AWG16 × 4C (20, 30m)
		AWG19 × 4C (2, 5, 10m)
		AWG19 × 4C (20, 30m)



Notes: 1. Contact Mitsubishi Electric System & Service Co., Ltd. FA PRODUCT DIVISION by email: oss-ip@melsc.jp
 2. Unlisted lengths are also available per meter: up to 10m for the servo amplifier power supply cable and for the motor power supply cable.
 3. -H and -L indicate a bending life. -H indicates a long bending life, and -L indicates a standard bending life.
 4. A separate motor-side power supply connector is required for HF-SP/HF-JP/HC-LP/HC-UP rotary servo motor series.

When manufacturing a cable with the following connectors, refer to the relevant manufacturers' instruction manuals for wiring and assembling procedures.



● **Servo amplifier main circuit power supply connector (CNP1) *A crimping tool is required.**

Model		Description	Applicable wire example
Receptacle housing	Receptacle contact		
J43FSS-03V-KX	BJ4F-71GF-M3.0	 JST Mfg. Co., Ltd.	Wire size: 1.25mm ² (AWG16) to 2.0mm ² (AWG14) Insulated outer diameter: φ2.0mm to φ3.8mm Crimping tool (YRF-1130) is required.

● **Servo amplifier control circuit power supply connector (CNP2) *A crimping tool is required.**

Model		Description	Applicable wire example
Receptacle housing	Receptacle contact		
F32FMS-06V-KXY	BF3F-71GF-P2.0	 JST Mfg. Co., Ltd.	Wire size: 1.25mm ² (AWG16) to 2.0mm ² (AWG14) Insulated outer diameter: φ2.4mm to φ3.4mm Crimping tool (YRF-1070) is required.
	LF3F-41GF-P2.0		Wire size: 0.75mm ² (AWG19) to 1.25mm ² (AWG16) Insulated outer diameter: φ1.8mm to φ2.8mm Crimping tool (YRF-880) is required.
3-178129-6	917511-2	 Tyco Electronics Corporation	Wire size: 1.25mm ² (AWG16) to 2.0mm ² (AWG14) Insulated outer diameter: φ2.2mm to φ2.8mm Crimping tool (91560-1) is required.
	353717-2		Wire size: 1.25mm ² (AWG16) to 2.0mm ² (AWG14) Insulated outer diameter: φ3.3mm to φ3.8mm Crimping tool (91561-1) is required.

● **Motor power supply connector (CNP3A/CNP3B) *A crimping tool is required.**

Model		Description	Applicable wire example
Receptacle housing	Receptacle contact		
F35FDC-04V-K	BF3F-71GF-P2.0	 JST Mfg. Co., Ltd.	Wire size: 1.25mm ² (AWG16) to 2.0mm ² (AWG14) Insulated outer diameter: φ2.4mm to φ3.4mm Crimping tool (YRF-1070) is required.
	LF3F-41GF-P2.0		Wire size: 0.75mm ² (AWG19) to 1.25mm ² (AWG16) Mitsubishi optional cable: MR-PWS1CBL□M-A□□ Insulated outer diameter: φ1.8mm to φ2.8mm Crimping tool (YRF-880) is required.
175363-1	917511-2	 Tyco Electronics Corporation	Wire size: 1.25mm ² (AWG16) to 2.0mm ² (AWG14) Insulated outer diameter: φ2.2mm to φ2.8mm Crimping tool (91560-1) is required.
	353717-2		Wire size: 1.25mm ² (AWG16) to 2.0mm ² (AWG14) Insulated outer diameter: φ3.3mm to φ3.8mm Crimping tool (91561-1) is required.
	175218-2		Mitsubishi optional cable: MR-PWS1CBL□M-A□□ Crimping tool (PEW12) and die assembly (1762957-1) are required.

Model designation
Servo motors
Servo amplifiers
Options
Peripheral equipment
MR-J3-BSafety
MR-J3W series
Servo support software
Cautions
Warranty
Global FA centers

MELSERVO-J3W

Options

● Battery case (MR-BTCASE) and battery (MR-BAT)

The battery case and the batteries are required when configuring absolute position detection system using the rotary servo motor or the direct drive motor.

MR-BTCASE is a case that stores 8 pieces of batteries (MR-BAT) by connecting the connectors. This battery case connects up to 4 units (8 axes) of MR-J3W-B servo amplifiers.

Use an optional cable, MR-J3BT2CBL□M for branching off the connection when connecting two or more servo amplifiers. The battery case and the batteries are not required when using the linear servo motor or when configuring incremental system. The batteries are not included with the battery case. Please purchase the batteries separately.

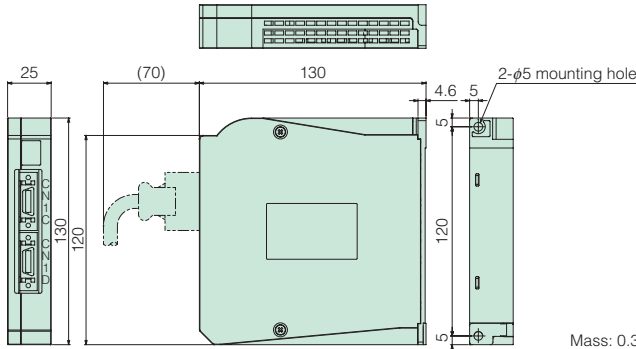
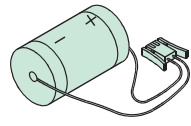
External dimensions (assembled) (Unit: mm)	MR-BAT
 <p style="text-align: right;">Mass: 0.3kg (0.66lb)</p>	 <p>Model: MR-BAT Nominal voltage: 3.6V Nominal capacity: 1700mAh Lithium content: 0.48g Primary battery: ER17330</p>

Note: MR-BAT is a lithium metal battery contains ER17330. MR-BAT is not subject to the dangerous goods (Class 9) of the UN Recommendations.

To transport lithium metal batteries and lithium metal batteries contained in equipment by means of transport subject to the UN Recommendations, take actions to comply with the following regulations: the United Nations Recommendations on the Transport of Dangerous Goods, the Technical Instruction (ICAO-TI) by the International Civil Aviation Organization (ICAO), and the International Maritime Dangerous Goods Code (IMDG Code) by the International Maritime Organization (IMO). To transport the batteries, check the latest standards or the laws of the destination country and take actions. For more information, contact your local sales office. (As of January 2011)

● Absolute position storage unit (MR-BTAS01)

This absolute position storage unit is required for configuring absolute position detection system using the direct drive motor. This unit is not required for the incremental system.

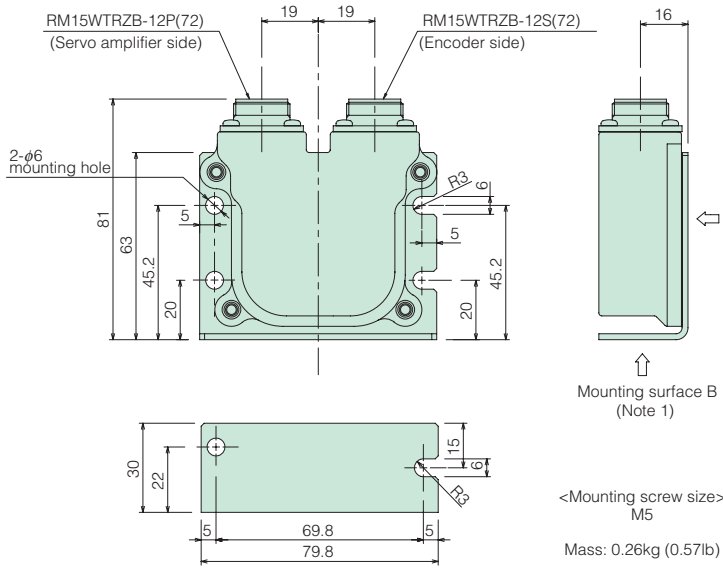
External dimensions (Unit: mm)													
 <p style="text-align: right;">Mass: 0.26kg (0.57lb)</p>	<table border="1"> <thead> <tr> <th>Item</th> <th>Environment</th> </tr> </thead> <tbody> <tr> <td>Ambient temperature</td> <td>0 to 55°C (32 to 131°F) (non freezing), Storage: -20 to 65 C (-4 to 149°F) (non freezing)</td> </tr> <tr> <td>Ambient humidity</td> <td>90%RH maximum (non condensing), Storage: 90%RH maximum (non condensing)</td> </tr> <tr> <td>Atmosphere</td> <td>Indoors (no direct sunlight); no corrosive gas, inflammable gas, oil mist, dust or splash of oil/water</td> </tr> <tr> <td>Elevation</td> <td>1000m or less above sea level</td> </tr> <tr> <td>Vibration</td> <td>When the surface A is mounted: 49m/s² or less (directions of X, Y and Z axes) When the surface B is mounted: 5.9m/s² or less (directions of X, Y and Z axes)</td> </tr> </tbody> </table>	Item	Environment	Ambient temperature	0 to 55°C (32 to 131°F) (non freezing), Storage: -20 to 65 C (-4 to 149°F) (non freezing)	Ambient humidity	90%RH maximum (non condensing), Storage: 90%RH maximum (non condensing)	Atmosphere	Indoors (no direct sunlight); no corrosive gas, inflammable gas, oil mist, dust or splash of oil/water	Elevation	1000m or less above sea level	Vibration	When the surface A is mounted: 49m/s ² or less (directions of X, Y and Z axes) When the surface B is mounted: 5.9m/s ² or less (directions of X, Y and Z axes)
Item	Environment												
Ambient temperature	0 to 55°C (32 to 131°F) (non freezing), Storage: -20 to 65 C (-4 to 149°F) (non freezing)												
Ambient humidity	90%RH maximum (non condensing), Storage: 90%RH maximum (non condensing)												
Atmosphere	Indoors (no direct sunlight); no corrosive gas, inflammable gas, oil mist, dust or splash of oil/water												
Elevation	1000m or less above sea level												
Vibration	When the surface A is mounted: 49m/s ² or less (directions of X, Y and Z axes) When the surface B is mounted: 5.9m/s ² or less (directions of X, Y and Z axes)												

Notes: 1. When mounting the absolute position storage unit outside a cabinet, be sure to mount the surface A with 4 screws. When mounting the unit inside a cabinet, mounting the surface B with 2 screws is also possible.

● Optional regeneration unit (MR-RB14, MR-RB34, MR-RB3B)

Servo amplifier	Tolerable regenerative power of built-in regenerative resistor (W)	Tolerable regenerative power of optional regeneration unit (W) (Note 1)		
		MR-RB14 [26Ω]	MR-RB34 [26Ω]	MR-RB3B [20Ω]
MR-J3W-22B	10	100	—	—
MR-J3W-44B		—	—	—
MR-J3W-77B	100	—	300	—
MR-J3W-1010B	100	—	—	300

Notes: 1 The power values in this table are resistor-generated powers, not rated powers.

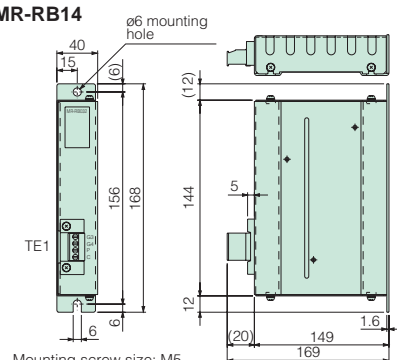
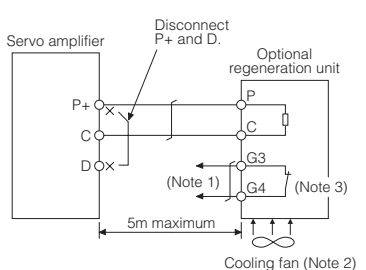
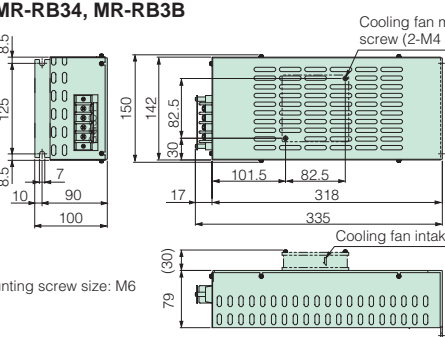
External dimensions	(Unit: mm)	Connections									
● MR-RB14  <p>Mounting screw size: M5</p>	<p><Terminal arrangement></p> <table border="1"> <tr><td>TE1</td></tr> <tr><td>G3</td></tr> <tr><td>G4</td></tr> <tr><td>P</td></tr> <tr><td>C</td></tr> </table> <p>Applicable wire size: 0.2mm² (AWG24) to 2.5mm² (AWG12)</p> <table border="1"> <thead> <tr> <th>Model</th> <th>Mass kg (lb)</th> </tr> </thead> <tbody> <tr> <td>MR-RB14</td> <td>1.1 (2.4)</td> </tr> </tbody> </table>	TE1	G3	G4	P	C	Model	Mass kg (lb)	MR-RB14	1.1 (2.4)	
TE1											
G3											
G4											
P											
C											
Model	Mass kg (lb)										
MR-RB14	1.1 (2.4)										
● MR-RB34, MR-RB3B  <p>Mounting screw size: M6</p>	<p><Terminal arrangement></p> <table border="1"> <tr><td>P</td></tr> <tr><td>C</td></tr> <tr><td>G3</td></tr> <tr><td>G4</td></tr> </table> <p>Terminal screw size: M4</p> <table border="1"> <thead> <tr> <th>Model</th> <th>Mass kg (lb)</th> </tr> </thead> <tbody> <tr> <td>MR-RB34</td> <td rowspan="2">2.9 (6.4)</td> </tr> <tr> <td>MR-RB3B</td> </tr> </tbody> </table>	P	C	G3	G4	Model	Mass kg (lb)	MR-RB34	2.9 (6.4)	MR-RB3B	
P											
C											
G3											
G4											
Model	Mass kg (lb)										
MR-RB34	2.9 (6.4)										
MR-RB3B											

- Notes: 1. Create a sequence circuit that turns off the magnetic contactor (MC) when abnormal overheating occurs.
 2. When the ambient temperature of the optional regeneration unit is 55°C or higher, and regenerative load ratio exceeds 60%, cool the unit forcibly with a cooling fan (92 × 92mm, minimum air flow: 1.0m³/min). Cooling fan is not required when the ambient temperature is 35°C or lower. The cooling fan must be prepared by user.
 3. The G3 and G4 terminals are thermal sensor. G3-G4 opens when the regeneration unit overheats abnormally.

● Junction terminal block (MR-TB26A)

All signals can be connected via the junction terminal block.

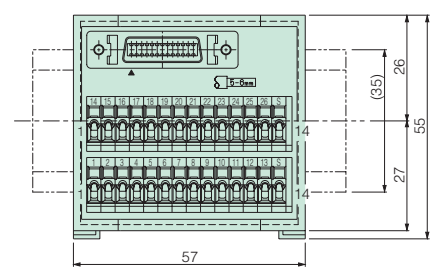
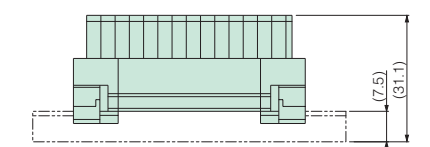
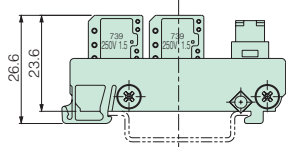
External dimensions (Note 1)		(Unit: mm)																	
		<p>Specifications</p> <table border="1"> <thead> <tr> <th>Rating</th> <th colspan="2">Max. 32VAC/32VDC, 0.5A</th> </tr> </thead> <tbody> <tr> <td rowspan="3">Applicable wire (terminal side)</td> <td>Stranded wire</td> <td>0.08mm² (AWG28) to 1.5mm² (AWG14)</td> </tr> <tr> <td>Solid wire</td> <td>φ0.32mm to φ1.2mm</td> </tr> <tr> <td>Insulated outer diameter</td> <td>φ3.4mm or smaller</td> </tr> <tr> <td>Operating tool</td> <td colspan="2">210-619 (Wago) or equivalent 210-119SB (Wago) or equivalent</td> </tr> <tr> <td>Strip length</td> <td colspan="2">5mm to 6mm</td> </tr> </tbody> </table>		Rating	Max. 32VAC/32VDC, 0.5A		Applicable wire (terminal side)	Stranded wire	0.08mm ² (AWG28) to 1.5mm ² (AWG14)	Solid wire	φ0.32mm to φ1.2mm	Insulated outer diameter	φ3.4mm or smaller	Operating tool	210-619 (Wago) or equivalent 210-119SB (Wago) or equivalent		Strip length	5mm to 6mm	
Rating	Max. 32VAC/32VDC, 0.5A																		
Applicable wire (terminal side)	Stranded wire	0.08mm ² (AWG28) to 1.5mm ² (AWG14)																	
	Solid wire	φ0.32mm to φ1.2mm																	
	Insulated outer diameter	φ3.4mm or smaller																	
Operating tool	210-619 (Wago) or equivalent 210-119SB (Wago) or equivalent																		
Strip length	5mm to 6mm																		
																			

Notes: 1. The lengths in () apply when the junction terminal box is mounted on a 35mm wide DIN rail.

Model designation
Servo motors
Servo amplifiers
Options
Peripheral equipment
MR-J3-BSafety
MR-J3W series
Servo support software
Cautions
Warranty
Global FA centers

Peripheral Equipment

● Electrical wires and magnetic contactors (example of selection)

The following are examples of wire sizes when 600V polyvinyl chloride insulated wires (IV wires) or 600V grade heat-resistant polyvinyl chloride insulated wires (HIV wires) with a length of 30m are used.

Servo amplifier	Circuit breaker (Note 3, 4)	Electrical wire size (mm ²)						
		L1, L2, L3, ⊕	L11, L21	U, V, W, ⊕ (Note 1)	P+, C	P+, D	B1, B2 (Note 2)	THM1, THM2
MR-J3W-22B	S-N10	2 (AWG14)					1.25 (AWG16)	0.2 (AWG24)
MR-J3W-44B								
MR-J3W-77B	S-N18	2 (AWG14)					1.25 (AWG16)	0.2 (AWG24)
MR-J3W-1010B								

- Notes: 1. Use a fluoric resin wire (0.75mm² (AWG19)) when connecting to a rotary servo motor power supply connector. Refer to "MR-J3W-□B SERVO AMPLIFIER INSTRUCTION MANUAL" for details on wiring cables.
 2. Use a fluoric resin wire (0.5mm² (AWG20)) when connecting to a rotary servo motor electromagnetic brake connector. Refer to "MR-J3W-□B SERVO AMPLIFIER INSTRUCTION MANUAL" for details on wiring cables.
 3. Be sure to use a magnetic contactor (MC) with an operation delay time of 80ms or less. The operation delay time is the time interval between current being applied to the coil until closure of contacts.
 4. Refer to "MR-J3W-□B SERVO AMPLIFIER INSTRUCTION MANUAL" for selecting a magnetic contactor when combining two motors among the rotary servo motor, the linear servo motor or the direct drive motor.

● Circuit breakers (example of selection) (Note 1)

Circuit breaker	Total output of rotary servo motor	Total output of linear servo motor	Total output of direct drive motor
30A frame 5A	300W or less	—	—
30A frame 10A	Over 300W to 600W	120N or less	100W or less
30A frame 15A	Over 600W to 1kW	Over 120N to 240N	Over 100W to 250W
30A frame 20A	Over 1kW to 2kW	Over 240N to 480N	Over 250W to 838W

- Notes: 1. Refer to "MR-J3W-□B SERVO AMPLIFIER INSTRUCTION MANUAL" for selecting a circuit breaker when combining two motors among the rotary servo motor, the linear servo motor or the direct drive motor.

● Power factor improvement AC reactor (FR-BAL) (Note 1)

Refer to P.133 in this catalog.

Model	Total output of rotary servo motor	Total output of linear servo motor	Total output of direct drive motor
FR-BAL-0.4K	300W or less	—	—
FR-BAL-0.75K	Over 300W to 450W	100N or less	100W or less
FR-BAL-1.5K	Over 450W to 600W	Over 100N to 120N	Over 100W to 150W
FR-BAL-2.2K	Over 600W to 1kW	Over 120N to 240N	Over 150W to 250W
FR-BAL-3.7K	Over 1kW to 2kW	Over 240N to 480N	Over 250W to 838W

- Notes: 1. Refer to "MR-J3W-□B SERVO AMPLIFIER INSTRUCTION MANUAL" for selecting a power factor improvement AC reactor when combining two motors among the rotary servo motor, the linear servo motor or the direct drive motor.

● EMC filter (HF3010A-UN, HF3030A-UN)

The following filters are recommended as a filter compliant with the EMC directive for the servo amplifier's power supply. Refer to P.130 in this catalog.

Model	Applicable servo amplifier
HF3010A-UN (Note 1)	MR-J3W-22B
	MR-J3W-44B
HF3030A-UN (Note 1)	MR-J3W-77B
	MR-J3W-1010B

- Notes: 1. A surge protector is separately required to use this EMC filter. Refer to "EMC Installation Guidelines".

● Radio noise filter (FR-BIF)

Refer to P.129 in this catalog.

● Line noise filter (FR-BSF01)

Refer to P.129 in this catalog.

● Data line filter

Refer to P.129 in this catalog.

● Surge killer

Refer to P.129 in this catalog.

Servo Support Software

Capacity selection software MRZJW3-MOTSZ111E

● Specifications

Item	Description
Types of machine component	Horizontal ball screws, vertical ball screws, rack and pinions, roll feeds, rotating tables, carts, elevators, conveyors, linear servo and other (direct inertia input) devices
Output of results	Items Selected servo amplifier, selected servo motor, selected optional regeneration unit, load inertia moment, load to motor inertia moment ratio, peak torque, peak torque ratio, effective torque, effective torque ratio, regenerative power, regenerative power ratio
	Printing Prints entered specifications, operation pattern, calculation process, graph of selection process feedrate (or motor speed) and torque, and sizing results.
	Data saving Entered specifications, operation patterns and selection results are saved with a file name.
Inertia moment calculation function	Cylinder, core alignment column, variable speed, linear movement, suspension, conical, truncated cone



● Operating conditions of personal computer

IBM PC/AT compatible model running with the following operation conditions.

Components	MRZJW3-MOTSZ111E (Note 2)
Personal computer (Note 1, 3)	OS (Note 4, 5) Windows® 98, Windows® Me, Windows® 2000 Professional, Windows® XP Professional, Windows® XP Home Edition, Windows Vista® Home Basic/Home Premium/Business/Ultimate/Enterprise
	Processor Pentium® 133MHz or more (Windows® 98, Windows® 2000 Professional) Pentium® 150MHz or more (Windows® Me) Pentium® 300MHz or more (Windows® XP Professional/Home Edition) 1GHz 32-bit (x86) (Windows Vista® Home Basic/Home Premium/Business/Ultimate/Enterprise)
	Memory 24MB or more (Windows® 98) 32MB or more (Windows® Me, Windows® 2000 Professional) 128MB or more (Windows® XP Professional, Windows® XP Home Edition) 512MB or more (Windows Vista® Home Basic) 1GB or more (Windows Vista® Home Premium/Business/Ultimate/Enterprise)
	Free hard disk space 40MB or more
	Communication interface —
	Browser Internet Explorer4.0 or above
Monitor Resolution 800 x 600 or more, 16-bit high color	
Keyboard Compatible with above personal computers.	
Mouse Compatible with above personal computers.	
Printer Compatible with above personal computers.	
Communication cable Not required	

- Notes: 1. Pentium is registered trademark of Intel Corporation. Windows and Windows Vista are registered trademarks of Microsoft Corporation in the United States and other countries.
 2. 7kW and 9kW of HF-JP servo motor series and MR-J3W-1010B servo amplifier will be compatible with C4 or above.
 3. This software may not run correctly, depending on a personal computer being used.
 4. Software version C0 is compatible with Windows Vista®.
 5. These software are not compatible with 64-bit operating system.

Servo Support Software

Setup software



● MR Configurator2 (SW1DNC-MRC2-E) specifications

Main menu	Functions
Project	Project creation, reading, saving or deleting, various data reading or writing, system setting, printing
Parameters	Parameter setting
Positioning data	Point table
Monitors	Batch display, input/output monitor display, graph, ABS data display
Diagnostics	Alarm display, display of data that generated alarm, reason for rotation failure display, system structure display, life diagnostic, fully closed loop diagnostic, linear diagnostic
Test operations	JOG operation, positioning operation, motor-less operation, forced digital output, program operation, 1-step feed, test operation information
Adjustment	Tuning, machine analyzer, advanced gain search
Others	Servo assistant, parameter setting range update, machine unit conversion setting, help display, connection to MELFANSweb



● MR Configurator (MRZJW3-SETUP221E) specifications

Main menu	Functions
Project	Project creation, reading or saving, various data reading, saving or printing
Monitors	Batch display, multiple axis batch display, input/output I/F display, optional unit I/F display, high-speed display, graph, multiple axis graph
Alarms	Alarm display, alarm history, display of data that generated alarm
Diagnostics	Reason for rotation failure display, system information display, tuning data display, absolute data display, system configuration list display, axis name setting, amplifier diagnostic (Note 1), fully closed loop diagnostic, linear diagnostic
Parameters	Parameter setting, multiple axis parameter setting, device setting, tuning, display of change list, display of detailed information, converter, parameter copy
Test operations	JOG operation, positioning operation, motor-less operation, forced digital output, program operation, 1-step feed
Advanced function	Machine analyzer, gain search, machine simulation, robust disturbance compensation, advanced gain search
Positioning data	Point table, program
Others	System setting, automatic operation, help display

Notes: 1. The amplifier diagnostic function is available only for MR-J3-□A□ and MR-J3-DU□A(4) with servo amplifier's software version A1 or above.



● Operating conditions of personal computer

IBM PC/AT compatible model running with the following operation conditions.

Components		MR Configurator2 (Note 2)	MR Configurator (Note 2)
Personal computer (Note 1, 3)	OS (Note 4)	Windows® 2000 Professional, Windows® XP Home Edition/Professional, Windows Vista® Home Basic/Home Premium/Business/Ultimate/Enterprise, Windows® 7 Starter/Home Premium/Professional/Ultimate/Enterprise	Windows® 98, Windows® Me, Windows® 2000 Professional, Windows® XP Home Edition/Professional, Windows Vista® Home Basic/Home Premium/Business/Ultimate/Enterprise, Windows® 7 Starter/Home Premium/Professional/Ultimate/Enterprise
	Processor (recommended)	Desktop PC: Celeron® processor 2.8GHz or more Laptop PC: Pentium® M processor 1.7GHz or more	Pentium® 133MHz or more(Windows® 98, Windows® 2000 Professional) Pentium® 150MHz or more(Windows® Me) Pentium® 300MHz or more(Windows® XP Home Edition/Professional) 1GHz 32-bit (x86)(Windows Vista® Home Basic/Home Premium/Business/Ultimate/Enterprise, Windows® 7 Starter/Home Premium/Professional/Ultimate/Enterprise)
	Memory (recommended)	1GB or more	24MB or more (Windows® 98), 32MB or more (Windows® Me, Windows® 2000 Professional), 128MB or more(Windows® XP Home Edition/Professional), 512MB or more(Windows Vista® Home Basic) 1GB or more (Windows Vista® Home Premium/Business/Ultimate/Enterprise, Windows® 7 Starter/Home Premium/Professional/Ultimate/Enterprise)
	Free hard disk space	1GB or more	130MB or more
	Communication interface	Use serial port or USB port	
Browser	Internet Explorer4.0 or above		
Monitor	Resolution 1024 x 768 or more, 16-bit high color		
Keyboard	Compatible with above personal computers.		
Mouse	Compatible with above personal computers.		
Printer	Compatible with above personal computers.		
Communication cable	MR-J3USBCBL3M		

Notes: 1. Celeron and Pentium are registered trademark of Intel Corporation. Windows and Windows Vista are registered trademarks of Microsoft Corporation in the United States and other countries.

2. Be sure to use the latest version of this software. Contact your local sales office for updating your software.

3. This software may not run correctly, depending on a personal computer being used.

4. This software is not compatible with 64-bit operating system.

Model Name Change for MR-J3-200

Model name of MR-J3-200A/B/T servo amplifiers are changed to MR-J3-200AN/BN/TN from July 2010 production. Dimensions and connectors are not changed from those of the servo amplifier manufactured between April 2008 and June 2010. Refer to the following and "Mitsubishi General-Purpose AC Servo Sales and Service No.10-11" for more details.

Manufactured date	March 2008 or earlier (Note 1)	April 2008 or later	July 2010 or later
Model	MR-J3-200A/B/T	MR-J3-200A/B/T	MR-J3-200AN/BN/TN
Type	MR-J3-A	MR-J3-B	MR-J3-T

Notes: 1. The servo amplifiers that are same as those manufactured March 2008 or earlier are also available. However, note that the shape of the mounting hole is changed. Contact your local sales office for more details.

2. The models of the connectors are as follows: CNP1: PC 4/ 6-STF-7,62-CRWH, CNP2: 54927-0520 and CNP3: PC 4/ 3-STF-7,62-CRWH

3. The models of the connectors are as follows: CNP1: 721-207/026-000, CNP2: 721-205/026-000 and CNP3: 721-203/026-000

4. CNP2 connector for passing wires (MR-J3CNP2-J1) is also available as an option. Refer to "Mitsubishi General-Purpose AC Servo Sales and Service No.10-11" for more details.

Combinations for Increasing the Maximum Torque

● Maximally increased torque for HF-KP servo motor series

The maximum torque of HF-KP servo motor can be increased from 300% to 350% of the rated torque with the following combinations of the servo motor and the servo amplifier by changing the parameter. Refer to "MR-J3-□B SERVO AMPLIFIER INSTRUCTION MANUAL" for setting parameters for MR-J3-B servo amplifier. Contact your local sales office for setting parameters for MR-J3-A and MR-J3-T.

Servo motor	Manufactured date (Note 1)
HF-KP□(B)	June 2009 or later

Servo amplifier	Servo amplifier software version (Note 2)	Manufactured month and year (Note 2)
MR-J3-□A(1)	C6 or later	January 2010 or later
MR-J3-□B(1)(-RJ006)/□S(1)	C4 or later	August 2009 or later
MR-J3-□T(1)	A8 or later	April 2010 or later

● Maximally increased torque for HF-JP servo motor series

The maximum torque of HF-KP servo motor can be increased from 300% to 400% of the rated torque with the following combinations of the servo motor and the servo amplifier.

Servo motor	Manufactured month and year (Note 1)
HF-JP□(4)(B)	April 2010 or later

Servo amplifier	Servo amplifier software version (Note 2)	Manufactured month and year (Note 2)
MR-J3-□A(4)	C6 or later	January 2010 or later
MR-J3-□B(4)(-RJ006)/BS(4)	C4 or later	August 2009 or later
MR-J3-□T(4)	A8 or later	April 2010 or later

Servo motor	Compatible servo amplifier		
	Standard servo amplifier (for max. torque: 300%)	Standard servo amplifier (for max. torque: 400%)	Special servo amplifier with U-number (Note 3) (for max. torque: 400% in conventional)
HF-JP53(B)	MR-J3-60A/B(-RJ006)/□S/T	MR-J3-100A/B(-RJ006)/□S/T	MR-J3-100A/B(-RJ006)/□S/T-U100
HF-JP73(B)	MR-J3-70A/B(-RJ006)/□S/T	MR-J3-200AN/BN(-RJ006)/□S/TN	MR-J3-200A/B(-RJ006)/□S/T-U101
HF-JP103(B)	MR-J3-100A/B(-RJ006)/□S/T	MR-J3-200AN/BN(-RJ006)/□S/TN	MR-J3-200A/B(-RJ006)/□S/T-U102
HF-JP153(B)	MR-J3-200AN/BN(-RJ006)/□S/TN	MR-J3-350A/B(-RJ006)/□S/T	MR-J3-350A/B(-RJ006)/□S/T-U103
HF-JP203(B)	MR-J3-200AN/BN(-RJ006)/□S/TN	MR-J3-350A/B(-RJ006)/□S/T	MR-J3-350A/B(-RJ006)/□S/T-U104
HF-JP353(B)	MR-J3-350A/B(-RJ006)/□S/T	MR-J3-500A/B(-RJ006)/□S/T	MR-J3-500A/B(-RJ006)/□S/T-U105
HF-JP503(B)	MR-J3-500A/B(-RJ006)/□S/T	MR-J3-700A/B(-RJ006)/□S/T	MR-J3-700A/B(-RJ006)/□S/T-U106
HF-JP534(B)	MR-J3-60A4/B4(-RJ006)/□S4/T4	MR-J3-100A4/B4(-RJ006)/□S4/T4	MR-J3-100A4/B4(-RJ006)/□S4/T4-U110
HF-JP734(B)	MR-J3-100A4/B4(-RJ006)/□S4/T4	MR-J3-200A4/B4(-RJ006)/□S4/T4	MR-J3-200A4/B4(-RJ006)/□S4/T4-U111
HF-JP1034(B)	MR-J3-100A4/B4(-RJ006)/□S4/T4	MR-J3-200A4/B4(-RJ006)/□S4/T4	MR-J3-200A4/B4(-RJ006)/□S4/T4-U112
HF-JP1534(B)	MR-J3-200A4/B4(-RJ006)/□S4/T4	MR-J3-350A4/B4(-RJ006)/□S4/T4	MR-J3-350A4/B4(-RJ006)/□S4/T4-U113
HF-JP2034(B)	MR-J3-200A4/B4(-RJ006)/□S4/T4	MR-J3-350A4/B4(-RJ006)/□S4/T4	MR-J3-350A4/B4(-RJ006)/□S4/T4-U114
HF-JP3534(B)	MR-J3-350A4/B4(-RJ006)/□S4/T4	MR-J3-500A4/B4(-RJ006)/□S4/T4	MR-J3-500A4/B4(-RJ006)/□S4/T4-U115
HF-JP5034(B)	MR-J3-500A4/B4(-RJ006)/□S4/T4	MR-J3-700A4/B4(-RJ006)/□S4/T4	MR-J3-700A4/B4(-RJ006)/□S4/T4-U116

Notes: 1. Refer to "SERVO MOTOR INSTRUCTION MANUAL (Vol.2)" for confirming the manufactured date (month and year) of the servo motor.

2. Refer to "MR-J3 SERVO AMPLIFIER INSTRUCTION MANUAL" for confirming the software version and the manufactured date (month and year) of the servo amplifier.

3. When using HF-JP servo motor manufactured on or before March 2010, MR-J3-□A/B(-RJ006)/□S/T-U□ servo amplifier is required to increase the maximum torque to 400%.

List of Compatible Servo Amplifier Software Versions

Servo amplifiers with the listed software version or above are compatible with the following linear encoders.

Manufacturers	Model	Compatible servo amplifier software version	
		MR-J3-B-RJ006	MR-J3W-B
Magnescale Co., Ltd.	SR77	B9	A1
	SR87	B9	A1
	SR75	A0	A1
	SR85	A0	A1
	SL710	A0	A1
Mitutoyo Corporation	AT343A	A0	A1
	AT543A-SC	A0	A1
	AT545A-SC	B9	A1
	ST741A	A0	A1
	ST742A	A0	A1
	ST743A	B0	A1
	ST744A	B0	A1
Heidenhain Corporation	LC 493M	B9	A1
	LC 193M	B9	A1
	LIDA 485	B9	A1
	LIDA 487	B9	A1
Renishaw Inc.	RGH26P	A0	A1
	RGH26Q	A0	A1
	RGH26R	A0	A1

Model designation
Servo motors
Servo amplifiers
Options
Peripheral equipment
MR-J3-BSafety
MR-J3W series
Servo support software
Cautions
Warranty
Global FA centers

To ensure safe use

- To use the products given in this catalog properly, always read the “Installation Guide” and “MR-J3 INSTRUCTION MANUAL” before starting to use them.

Cautions concerning use

Transportation and installation of servo motor

- Protect the servo motor and the encoder from impact during handling. When installing a pulley or a coupling to the shaft, do not hammer on the shaft. Impact may damage the encoder. When installing the pulley or the coupling to the servo motor which has a key way on the shaft, use the screw hole on the shaft-end. Use a pulley extractor when removing the pulley.



- Do not apply a load exceeding the tolerable load onto the servo motor shaft. The shaft may break.

Installation

- Avoid installation in an environment in which oil mist, dust, etc. are in the air. When using in such an environment, enclose the servo amplifier in a sealed cabinet. Protect the servo motor by furnishing a cover for it or by taking similar measures.
- Mount the servo amplifier vertically on a wall.
- Do not block intake and exhaust areas of the servo amplifier. Doing so may cause the servo amplifier to malfunction.
- When installing several servo amplifiers in a row in a sealed cabinet, leave 10mm or more open between each servo amplifier. MR-J3-350□ or smaller servo amplifier can be installed closely. In this case, keep the ambient temperature within 0°C to 45°C (32°F to 113°F), or use them with 75% or less of the effective load rate.

When using one servo amplifier, always leave 40mm or more open in the upward and downward directions.

To ensure the life and reliability, keep space as open as possible toward the top plate so that heat does not build up.

Take special care, especially when installing several servo amplifiers in a row.

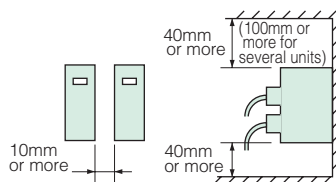

- Be sure to use the servo motor within the specified ambient temperature. Torque may drop due to temperature increase of the servo motor.
- The servo motor can be mounted in any direction. When mounting vertically (shaft-up), take measures on the machine-side to ensure that oil from the gear box does not get into the servo motor.

- Do not touch the servo motor during or after operation until it has had sufficient time to cool. The servo motor can be very hot, and severe burns may result from touching the servo motor.
- The optional regeneration unit becomes hot (the temperature rise of 100°C or more) with frequent use. Do not install within flammable objects or objects subject to thermal deformation. Take care to ensure that electrical wires do not come into contact with the unit.
- Carefully consider the cable clamping method, and make sure that bending stress and stress of the cable's own weight are not applied on the cable connection section.
- If using in an application where the servo motor moves, select the cable bending radius according to the required bending life and wire type.

Grounding

- Securely ground to prevent electric shocks and to stabilize the potential in the control circuit.
- To ground the servo motor and the servo amplifier at one point, connect the grounding terminals of each unit, and ground from the servo amplifier side.
- Faults such as position mismatch may occur if the grounding is insufficient.

Wiring

- When a commercial power supply is applied to the servo amplifier's output terminals (U, V, W), the servo amplifier will be damaged. Before switching the power on, perform thorough wiring and sequence checks to ensure that there are no wiring errors, etc.
- When a commercial power supply is applied to the servo motor's input terminals (U, V, W), the servo motor will be damaged. Connect the servo motor to the servo amplifier's output terminals (U, V, W).
- Match the phase of the servo motor's input terminals (U, V, W) to the servo amplifier's output terminals (U, V, W) when connecting. If they do not match, the servo motor cannot be controlled.
- Validate the stroke end signals (LSP, LSN) in position control or speed control mode.
The servo motor will not start if the signals are invalid.
- Do not apply excessive tension on the fiber-optic cable when cabling.
- The minimum bending radius of the fiber-optic cable is 25mm for MR-J3BUS□M and 50mm for MR-J3BUS□M-A/-B.
If using these cables under the minimum bending radius, performance cannot be guaranteed.
- If the ends of the fiber-optic cable are dirty, the light will be obstructed, resulting malfunctions. Always clean the ends if dirty.
- Do not tighten the fiber-optic cable with cable ties, etc.
- Do not look directly at the light when the fiber-optic cable is not connected.
- Do not use the 24VDC interface power supply for the electromagnetic brake. Provide a power supply designed exclusively for the electromagnetic brake.

Factory settings

- All available combinations of the servo motor and the servo amplifier are predetermined. Confirm the models of the servo motor and the servo amplifier to be used before installation.
- For MR-J3-A, select a control mode of position, speed or torque control with parameter PA01. Position control mode is selected as default. Change the parameter setting when using the other control modes.
For MR-J3-B, the control mode is selected by the controller.
- When using the optional regeneration unit, change parameter No.PA02. The optional regeneration unit is disabled as default, so the parameter must be changed to increase the regeneration performance.

Operation

- When a magnetic contactor (MC) is installed on the servo amplifier's primary side, do not perform frequent starts and stops with the MC. Doing so may cause the servo amplifier to malfunction.
- When an error occurs, the servo amplifier's safety features activates, halting output, and the dynamic brake instantly stops the servo motor. If free run is required, contact your local sales office about solutions involving servo amplifiers where the dynamic brake is not activated.
- The dynamic brake is a function for emergency stop. Do not use it for stopping the servo motor in normal operations.
- As a rough guide, the dynamic brake can be used approximately 1000 times when a machine that has load to motor inertia moment ratio equals to or lower than the recommended ratio stops from the rated speed every 10 minutes.
- When using the servo motor with an electromagnetic brake, do not apply the electromagnetic brake when the servo is on. Doing so may cause the servo amplifier overload or shorten the brake life. Apply the electromagnetic brake when the servo is off.

Cautions concerning model selection

- Select the servo motor with a rated torque above the continuous effective load torque.
- When unbalanced torque is generated, such as in a vertical lift machine, it is recommended that the unbalanced torque of the machine be kept under 70% of the motor's rated torque.
- Design the operation pattern in the command section so that positioning can be completed, taking the stop setting time (t_s) into account.

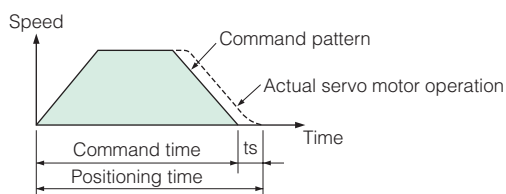

- The load inertia moment should be below the recommended load to motor inertia moment ratio of the servo motor being used. If it is too large, desired performance may not be attainable.

Regarding safety standard certification

Even though the MR-J3-B Safety servo amplifier and MR-J3-D05 safety logic unit are certified to various safety standards, this does not guarantee that the systems in which they are installed will also be certified. With the entire system in mind, comply strictly with the following:

- All safety-related components such as relays, sensors, etc., must meet the applicable safety standards.
- For details regarding the use of safety functions and other cautionary information, refer to "MR-J3-□B Safety MR-J3-D05 SERVO AMPLIFIER INSTRUCTION MANUAL".
- Perform risk assessment and safety level certification on the entire machine/system. It is recommended to use a Certification Body (TÜV Rheinland, etc.) for final safety certification.

Warranty

1. Warranty period and coverage

We will repair any failure or defect hereinafter referred to as "failure" in our FA equipment hereinafter referred to as the "Product" arisen during warranty period at no charge due to causes for which we are responsible through the distributor from which you purchased the Product or our service provider. However, we will charge the actual cost of dispatching our engineer for an on-site repair work on request by customer in Japan or overseas countries. We are not responsible for any on-site readjustment and/or trial run that may be required after a defective unit is repaired or replaced.

[Term]

The term of warranty for Product is twelve (12) months after your purchase or delivery of the Product to a place designated by you or eighteen (18) months from the date of manufacture whichever comes first ("Warranty Period"). Warranty period for repaired Product cannot exceed beyond the original warranty period before any repair work.

[Limitations]

- (1) You are requested to conduct an initial failure diagnosis by yourself, as a general rule. It can also be carried out by us or our service company upon your request and the actual cost will be charged. However, it will not be charged if we are responsible for the cause of the failure.
- (2) This limited warranty applies only when the condition, method, environment, etc. of use are in compliance with the terms and conditions and instructions that are set forth in the instruction manual and user manual for the Product and the caution label affixed to the Product.
- (3) Even during the term of warranty, the repair cost will be charged on you in the following cases;
 - (i) a failure caused by your improper storing or handling, carelessness or negligence, etc., and a failure caused by your hardware or software problem
 - (ii) a failure caused by any alteration, etc. to the Product made on your side without our approval
 - (iii) a failure which may be regarded as avoidable, if your equipment in which the Product is incorporated is equipped with a safety device required by applicable laws and has any function or structure considered to be indispensable according to a common sense in the industry
 - (iv) a failure which may be regarded as avoidable if consumable parts designated in the instruction manual, etc. are duly maintained and replaced
 - (v) any replacement of consumable parts (battery, fan, smoothing capacitor, etc.)
 - (vi) a failure caused by external factors such as inevitable accidents, including without limitation fire and abnormal fluctuation of voltage, and acts of God, including without limitation earthquake, lightning and natural disasters
 - (vii) a failure generated by an unforeseeable cause with a scientific technology that was not available at the time of the shipment of the Product from our company
 - (viii) any other failures which we are not responsible for or which you acknowledge we are not responsible for

2. Term of warranty after the stop of production

- (1) We may accept the repair at charge for another seven (7) years after the production of the product is discontinued. The announcement of the stop of production for each model can be seen in our Sales and Service, etc.
- (2) Please note that the Product (including its spare parts) cannot be ordered after its stop of production.

3. Service in overseas countries

Our regional FA Center in overseas countries will accept the repair work of the Product. However, the terms and conditions of the repair work may differ depending on each FA Center. Please ask your local FA Center for details.

4. Exclusion of responsibility for compensation against loss of opportunity, secondary loss, etc.

Whether under or after the term of warranty, we assume no responsibility for any damages arisen from causes for which we are not responsible, any losses of opportunity and/or profit incurred by you due to a failure of the Product, any damages, secondary damages or compensation for accidents arisen under a specific circumstance that are foreseen or unforeseen by our company, any damages to products other than the Product, and also compensation for any replacement work, readjustment, start-up test run of local machines and the Product and any other operations conducted by you.

5. Change of Product specifications

Specifications listed in our catalogs, manuals or technical documents may be changed without notice.

6. Application and use of the Product

- (1) For the use of our General-Purpose AC Servo, its applications should be those that may not result in a serious damage even if any failure or malfunction occurs in General-Purpose AC Servo, and a backup or fail-safe function should operate on an external system to General-Purpose AC Servo when any failure or malfunction occurs.
- (2) Our General-Purpose AC Servo is designed and manufactured as a general purpose product for use at general industries. Therefore, applications substantially influential on the public interest for such as atomic power plants and other power plants of electric power companies, and also which require a special quality assurance system, including applications for railway companies and government or public offices are not recommended, and we assume no responsibility for any failure caused by these applications when used.

In addition, applications which may be substantially influential to human lives or properties for such as airlines, medical treatments, railway service, incineration and fuel systems, man-operated material handling equipment, entertainment machines, safety machines, etc. are not recommended, and we assume no responsibility for any failure caused by these applications when used.

We will review the acceptability of the abovementioned applications, if you agree not to require a specific quality for a specific application. Please contact us for consultation.

Global FA Centers



Shanghai FA Center	Mitsubishi Electric Automation (CHINA) Ltd. 4/F., Zhi Fu Plaza No.80 Xin Chang Road, Shanghai, 200003, China Tel: 86-21-2322-3030 Fax: 86-21-2322-3000	India FA Center	Mitsubishi Electric India Pvt. Ltd. India Factory Automation Centre 2nd Floor, DLF Building No.9B, DLF Cyber City Phase III, Gurgaon 122002, Haryana, India Tel: 91-124-4630300 Fax: 91-124-4630399
Beijing FA Center	Mitsubishi Electric Automation (CHINA) Ltd. Beijing Office Unit904-905, 9F, Office Tower, Henderson Centre, 18 Jianguomennei Avenue, Dongcheng District, Beijing, China Tel: 86-10-6518-8830 Fax: 86-10-6518-3907	North American FA Center	Mitsubishi Electric Automation, Inc. 500 Corporate Woods Parkway, Vernon Hills, IL 60061, U.S.A Tel: 1-847-478-2100 Fax: 1-847-478-2253
Tianjin FA Center	Mitsubishi Electric Automation (CHINA) Ltd. Tianjin Office B-2-801-802, Youyi Building, 50 Youyi Road, Hexi District, Tianjin, China Tel: 86-22-2813-1015 Fax: 86-22-2813-1017	Brazil FA Center	MELCO-TEC Representacao Comercial e Assessoria Tecnica Ltda. Av. Paulista, 1439, Cerqueira Cesar - Sao Paulo Brazil - CEP 01311-200 Tel: 55-11-3146-2200 Fax: 55-11-3146-2217
Guangzhou FA Center	Mitsubishi Electric Automation (CHINA) Ltd. Guangzhou Office Rm.1609, North Tower, The Hub Center, No.1068, Xin Gang East Road, Haizhu District, Guangzhou, China Tel: 86-20-8923-6730 Fax: 86-20-8923-6715	European FA Center	Mitsubishi Electric Europe B.V. Polish Branch ul. Krakowska 50, 32-083 Balice, Poland Tel: 48-12-630-4700 Fax: 48-12-630-4701
Hong Kong FA Center	Mitsubishi Electric Automation (HONGKONG) Ltd. 10th Floor, Manulife Tower, 169 Electric Road, North Point, Hong Kong Tel: 852-2887-8870 Fax: 852-2887-7984	German FA Center	Mitsubishi Electric Europe B.V. - German Branch Gothaer Strasse 8, D-40880 Ratingen, Germany Tel: 49-2102-486-0 Fax: 49-2102-486-1120
Taiwan FA Center	Setsuyo Enterprise Co., Ltd. 6F No.105 Wu kung 3rd RD, Wu-Ku Hsiang, Taipei Hsien, 248, Taiwan, R.O.C. Tel: 886-2-2299-2499 Fax: 886-2-2299-2509	Czech Republic FA Center	Mitsubishi Electric Europe B.V. -o.s. Czech office Avenir Business Park, Radicka 714/113a, 158 00 Praha5, Czech Republic Tel: 420-251-551-470 Fax: 420-251-551-471
Korean FA Center	Mitsubishi Electric Automation Korea Co., Ltd. (Service) B1F, 2F, 1480-6, Gayang-Dong, Gangseo-Gu, Seoul, 157-200, Korea Tel: 82-2-3660-9630 Fax: 82-2-3663-0475	UK FA Center	Mitsubishi Electric Europe B.V. UK Branch Travellers Lane, Hatfield, Hertfordshire, AL10 8XB, UK. Tel: 44-1707-27-6100 Fax: 44-1707-27-8695
Thailand FA Center	Mitsubishi Electric Automation (Thailand) Co., Ltd. Bang-Chan Industrial Estate No.111, Soi Serithai 54, T.Kannayao, A.Kannayao, Bangkok 10230, Thailand Tel: 66-2906-3238 Fax: 66-2906-3239	Russian FA Center	Mitsubishi Electric Europe B.V. Russian Branch St.Petersburg office Sverdlovskaya emb., bld "Sch", BC "Benua", office 720; 195027, St.Petersburg, Russia Tel: 7-812-633-3497 Fax: 7-812-633-3499
ASEAN FA Center	Mitsubishi Electric Asia Pte. Ltd. ASEAN Factory Automation Centre 307 Alexandra Road #05-01/02, Mitsubishi Electric Building, Singapore Tel: 65-6470-2460 Fax: 65-6476-7439		

Mitsubishi Electric Corporation Nagoya Works is a factory certified for ISO14001 (standards for environmental management systems) and ISO9001 (standards for quality assurance management systems)



Model designation

Servo motors

Servo amplifiers

Options

Peripheral equipment

MR-J3-B Safety

MR-J3W series

Servo support software

Cautions

Warranty

Global FA centers

 **Safety Warning**

To ensure proper use of the products listed in this catalog,
please be sure to read the instruction manual prior to use.

 **mitsubishi electric corporation**
HEAD OFFICE : TOKYO BLDG., 2-7-3, MARUNOUCHI, CHIYODA-KU, TOKYO 100-8310, JAPAN