

Programmable Controller

Transition from MELSEC-A/QnA
(Large Type) Series to Q Series Handbook

(Fundamentals)





Mar. 2021 Edition

● SAFETY PRECAUTIONS ●

(Read these precautions before using this product.)

Before using products introduced in this publication, please read relevant manuals and replacement handbooks carefully and pay full attention to safety to handle the product correctly.

In this publication, the safety precautions are classified into two levels:

" WARNING" and " CAUTION".



Indicates that incorrect handling may cause hazardous conditions, resulting in death or severe injury.



Indicates that incorrect handling may cause hazardous conditions, resulting in minor or moderate injury or property damage.

Under some circumstances, failure to observe the precautions given under " CAUTION" may lead to serious consequences.

Observe the precautions of both levels because they are important for personal and system safety. Make sure that the end users read this publication and keep it in a safe place for future reference.

[Design Precautions]

WARNING

- Configure safety circuits external to the programmable controller to ensure that the entire system operates safely even when a fault occurs in the external power supply or the programmable controller. Failure to do so may result in an accident due to an incorrect output or malfunction.
 - (1) Configure external safety circuits, such as an emergency stop circuit, protection circuit, and protective interlock circuit for forward/reverse operation or upper/lower limit positioning.
 - (2) The programmable controller stops its operation upon detection of the following status, and the output status of the system will be as shown below.

	Q series module	A series module
Overcurrent or overvoltage protection of the power supply module is activated.	All outputs are turned off	All outputs are turned off
The CPU module detects an error such as a watchdog timer error by the self-diagnostic function.	All outputs are held or turned off according to the parameter setting.	All outputs are turned off

All outputs may turn on when an error occurs in the part, such as I/O control part, where the CPU module cannot detect any error. To ensure safety operation in such a case, provide a safety mechanism or a fail-safe circuit external to the programmable controller. For a fail-safe circuit example, refer to General Safety Requirements in the QCPU User's Manual (Hardware Design, Maintenance and Inspection).

- (3) Outputs may remain on or off due to a failure of an output module relay or transistor. Configure an external circuit for monitoring output signals that could cause a serious accident.
- In an output module, when a load current exceeding the rated current or an overcurrent caused by a load short-circuit flows for a long time, it may cause smoke and fire. To prevent this, configure an external safety circuit, such as a fuse.
 - Configure a circuit so that the programmable controller is turned on first and then the external power supply.
If the external power supply is turned on first, an accident may occur due to an incorrect output or malfunction.
 - For the operating status of each station after a communication failure, refer to relevant manuals for the network.
Incorrect output or malfunction due to a communication failure may result in an accident.

[Design Precautions]



WARNING

- When changing data of the running programmable controller from a peripheral connected to the CPU module or from a personal computer connected to an intelligent function module/special function module, configure an interlock circuit in the sequence program to ensure that the entire system will always operate safely.

For other forms of control (such as program modification or operating status change) of a running programmable controller, read the relevant manuals carefully and ensure that the operation is safe before proceeding.

Especially, in the case of a control from an external device to a remote programmable controller, immediate action cannot be taken for a problem on the programmable controller due to a communication failure.

To prevent this, configure an interlock circuit in the sequence program, and determine corrective actions to be taken between the external device and CPU module in case of a communication failure.



CAUTION

- Do not install the control lines or communication cables together with the main circuit lines or power cables.

Keep a distance of 100mm or more between them.

Failure to do so may result in malfunction due to noise.

- When a device such as a lamp, heater, or solenoid valve is controlled through an output module, a large current (approximately ten times greater than normal) may flow when the output is turned from off to on.

Take measures such as replacing the module with one having a sufficient current rating.

- After the CPU module is powered on or is reset, the time taken to enter the RUN status varies depending on the system configuration, parameter settings, and/or program size. Design circuits so that the entire system will always operate safely, regardless of the time.

[Installation Precautions]

CAUTION

- Use the programmable controller in an environment that meets the general specifications in the QCPU User's Manual (Hardware Design, Maintenance and Inspection).
Failure to do so may result in electric shock, fire, malfunction, or damage to or deterioration of the product.
- To mount the module, while pressing the module mounting lever located in the lower part of the module, fully insert the module fixing projection(s) into the hole(s) in the base unit and press the module until it snaps into place.
Incorrect mounting may cause malfunction, failure or drop of the module.
When using the programmable controller in an environment of frequent vibrations, fix the module with a screw.
Tighten the screw within the specified torque range.
Undertightening can cause drop of the screw, short circuit or malfunction.
Overtightening can damage the screw and/or module, resulting in drop, short circuit, or malfunction.
- When using an extension cable, connect it to the extension cable connector of the base unit securely.
Check the connection for looseness.
Poor contact may cause incorrect input or output.
- When using a memory card, fully insert it into the memory card slot.
Check that it is inserted completely.
Poor contact may cause malfunction.
- When using an SD memory card, fully insert it into the SD memory card slot. Check that it is inserted completely. Poor contact may cause malfunction.
- Securely insert an extended SRAM cassette into the cassette connector of the CPU module. After insertion, close the cassette cover to prevent the cassette from coming off. Poor contact may cause malfunction.
- Shut off the external power supply for the system in all phases before mounting or removing the module. Failure to do so may result in damage to the product.
A module can be replaced online (while power is on) on any MELSECNET/H remote I/O station or in the system where a CPU module supporting the online module change function is used.
Note that there are restrictions on the modules that can be replaced online, and each module has its predetermined replacement procedure.
For details, refer to the relevant sections in the QCPU User's Manual (Hardware Design, Maintenance and Inspection) and in the manual for the corresponding module.

[Installation Precautions]



CAUTION

- Do not directly touch any conductive parts and electronic components of the module, memory card, SD memory card, or extended SRAM cassette. Doing so can cause malfunction or failure of the module.
- When using a Motion CPU module and modules designed for motion control, check that the combinations of these modules are correct before applying power. The modules may be damaged if the combination is incorrect. For details, refer to the user's manual for the Motion CPU module.

[Wiring Precautions]



WARNING

- Shut off the external power supply for the system in all phases before wiring.
Failure to do so may result in electric shock or damage to the product.
- After wiring, attach the included terminal cover to the module before turning it on for operation.
Failure to do so may result in electric shock.

 **CAUTION**

- Individually ground the FG and LG terminals of the programmable controller with a ground resistance of 100 ohms or less. Failure to do so may result in electric shock or malfunction.
- Use applicable solderless terminals and tighten them within the specified torque range. If any spade solderless terminal is used, it may be disconnected when the terminal screw comes loose, resulting in failure.
- Check the rated voltage and terminal layout before wiring to the module, and connect the cables correctly.
Connecting a power supply with a different voltage rating or incorrect wiring may cause a fire or failure.
- Connectors for external connection must be crimped or pressed with the tool specified by the manufacturer, or must be correctly soldered.
Incomplete connections could result in short circuit, fire, or malfunction.
- Securely connect the connector to the module. Poor contact may cause malfunction.
- Do not install the control lines or communication cables together with the main circuit lines or power cables. Keep a distance of 100mm or more between them. Failure to do so may result in malfunction due to noise.
- Place the cables in a duct or clamp them. If not, dangling cable may swing or inadvertently be pulled, resulting in damage to the module or cables or malfunction due to poor contact.
- Check the interface type and correctly connect the cable. Incorrect wiring (connecting the cable to an incorrect interface) may cause failure of the module and external device.
- Tighten the terminal screw within the specified torque range.
Undertightening can cause short circuit, fire, or malfunction.
Overtightening can damage the screw and/or module, resulting in drop, short circuit, or malfunction.
- Prevent foreign matter such as dust or wire chips from entering the module.
Such foreign matter can cause a fire, failure, or malfunction.

[Wiring Precautions]

CAUTION

- A protective film is attached to the top of the module to prevent foreign matter, such as wire chips, from entering the module during wiring.
Do not remove the film during wiring.
Remove it for heat dissipation before system operation.
- When disconnecting the cable from the module, do not pull the cable by the cable part. For the cable with connector, hold the connector part of the cable. For the cable connected to the terminal block, loosen the terminal screw. Pulling the cable connected to the module may result in malfunction or damage to the module or cable.
- Mitsubishi programmable controllers must be installed in control panels.
Connect the main power supply to the power supply module in the control panel through a relay terminal block.
Wiring and replacement of a power supply module must be performed by maintenance personnel who is familiar with protection against electric shock. (For wiring methods, refer to the QCPU User's Manual (Hardware Design, Maintenance and Inspection)).

[Startup and Maintenance Precautions]

WARNING

- Do not touch any terminal while power is on.
Doing so will cause electric shock or malfunction.
- Correctly connect the battery connector.
Do not charge, disassemble, heat, short-circuit, solder, or throw the battery into the fire. Also, do not expose it to liquid or strong shock. Doing so will cause the battery to produce heat, explode, ignite, or leak, resulting in injury and fire.
- Shut off the external power supply for the system in all phases before cleaning the module or retightening the terminal screws or module fixing screws.
Failure to do so may result in electric shock.

[Startup and Maintenance Precautions]

CAUTION

- Before performing online operations (especially, program modification, forced output, and operation status change) for the running CPU module from the peripheral connected, read relevant manuals carefully and ensure the safety.
Improper operation may damage machines or cause accidents.
- Do not disassemble or modify the modules.
Doing so may cause failure, malfunction, injury, or a fire.
- Use any radio communication device such as a cellular phone or PHS (Personal Handy-phone System) more than 25cm away in all directions from the programmable controller.
Failure to do so may cause malfunction.
- Shut off the external power supply for the system in all phases before mounting or removing the module. Failure to do so may cause the module to fail or malfunction.
A module can be replaced online (while power is on) on any MELSECNET/H remote I/O station or in the system where a CPU module supporting the online module change function is used.
Note that there are restrictions on the modules that can be replaced online, and each module has its predetermined replacement procedure.
For details, refer to the relevant sections in the QCPU User's Manual (Hardware Design, Maintenance and Inspection) and in the manual for the corresponding module.
- After the first use of the product, do not mount/remove the module to/from the base unit, and the terminal block to/from the module, and do not insert/remove the extended SRAM cassette to/from the CPU module more than 50 times (IEC 61131-2 compliant) respectively. Exceeding the limit may cause malfunction.
- After the first use of the product, do not insert/remove the SD memory card to/from the CPU module more than 500 times. Exceeding the limit may cause malfunction.
- Do not drop or apply shock to the battery to be installed in the module.
Doing so may damage the battery, causing the battery fluid to leak inside the battery.
If the battery is dropped or any shock is applied to it, dispose of it without using.
- Before handling the module, touch a grounded metal object to discharge the static electricity from the human body.
Failure to do so may cause the module to fail or malfunction.

[Disposal Precautions] **CAUTION**

- When disposing of this product, treat it as industrial waste.
When disposing of batteries, separate them from other wastes according to the local regulations.
(For details of the battery directive in EU member states, refer to the QCPU User's Manual (Hardware Design, Maintenance and Inspection).)

[Transportation Precautions] **CAUTION**

- When transporting lithium batteries, follow the transportation regulations.
(For details of the regulated models, refer to the QCPU User's Manual (Hardware Design, Maintenance and Inspection).)

● CONDITIONS OF USE FOR THE PRODUCT ●

(1) Mitsubishi programmable controller ("the PRODUCT") shall be used in conditions;

i) where any problem, fault or failure occurring in the PRODUCT, if any, shall not lead to any major or serious accident;
and

ii) where the backup and fail-safe function are systematically or automatically provided outside of the PRODUCT for the case of any problem, fault or failure occurring in the PRODUCT.

(2) The PRODUCT has been designed and manufactured for the purpose of being used in general industries.

MITSUBISHI SHALL HAVE NO RESPONSIBILITY OR LIABILITY (INCLUDING, BUT NOT LIMITED TO ANY AND ALL RESPONSIBILITY OR LIABILITY BASED ON CONTRACT, WARRANTY, TORT, PRODUCT LIABILITY) FOR ANY INJURY OR DEATH TO PERSONS OR LOSS OR DAMAGE TO PROPERTY CAUSED BY the PRODUCT THAT ARE OPERATED OR USED IN APPLICATION NOT INTENDED OR EXCLUDED BY INSTRUCTIONS, PRECAUTIONS, OR WARNING CONTAINED IN MITSUBISHI'S USER, INSTRUCTION AND/OR SAFETY MANUALS, TECHNICAL BULLETINS AND GUIDELINES FOR the PRODUCT.

("Prohibited Application")

Prohibited Applications include, but not limited to, the use of the PRODUCT in;

- Nuclear Power Plants and any other power plants operated by Power companies, and/or any other cases in which the public could be affected if any problem or fault occurs in the PRODUCT.
- Railway companies or Public service purposes, and/or any other cases in which establishment of a special quality assurance system is required by the Purchaser or End User.
- Aircraft or Aerospace, Medical applications, Train equipment, transport equipment such as Elevator and Escalator, Incineration and Fuel devices, Vehicles, Manned transportation, Equipment for Recreation and Amusement, and Safety devices, handling of Nuclear or Hazardous Materials or Chemicals, Mining and Drilling, and/or other applications where there is a significant risk of injury to the public or property.

Notwithstanding the above restrictions, Mitsubishi may in its sole discretion, authorize use of the PRODUCT in one or more of the Prohibited Applications, provided that the usage of the PRODUCT is limited only for the specific applications agreed to by Mitsubishi and provided further that no special quality assurance or fail-safe, redundant or other safety features which exceed the general specifications of the PRODUCTS are required. For details, please contact the Mitsubishi representative in your region.

REVISIONS

* The handbook number is given on the bottom left of the back cover.

Print Date	* Handbook Number	Revision
Mar. 2005	L(NA)08043ENG-A	First edition
Apr. 2005	L(NA)08043ENG-B	<p>Correction</p> <p>Section 3.2.1, 3.2.2, 3.2.3, 7.2.1, Appendix 1</p> <p>Addition</p> <p>Appendix 1.1</p> <p>Changed item numbers</p> <p>Appendix 1.1 to Appendix 1.4 → Appendix 1.2 to Appendix 1.5</p>
Oct. 2005	L(NA)08043ENG-C	<p>Addition</p> <p>Appendix 1, Appendix 2</p> <p>Partial correction</p> <p>Contents, Section 1.1.2, 3.2.1, 3.2.2, 5.1, 5.2.2, 7.4.1, 7.4.3, 7.5.1, 7.5.3, Appendix 1 → Appendix 3</p>
Nov. 2007	L(NA)08043ENG-D	<p>Addition</p> <p>Section 3.2.1(16), 5.5, 7.7.7</p> <p>Partial correction</p> <p>Entire review of terms and symbols in tables, SAFETY PRECAUTIONS, Section 1.1, 1.1.1, 1.1.2, 1.1.3, 2.3.1, 2.3.2, 3.1, 3.2.1 to 3.2.4, 4.1, 5.4, 7.2.3, 7.7.1, 7.7.7 to 7.7.11 → 7.7.8 to 7.7.12, 8.1, 8.3, Appendix 3.2</p>
Apr. 2008	L(NA)08043ENG-E	<p>Addition of modules to be replaced</p> <p>Q series large type blank cover, Q series large type I/O module, Q series large type base unit</p> <p>Addition</p> <p>Section 1.1.2(3), 3.2.3(2), 5.6, Appendix 3.1(1), Appendix 3.1(3), Appendix 3.6</p> <p>Partial correction</p> <p>Term revision (whole), Section 1.1.2, 2.4.4, 2.4.5, 3.2.1, 3.2.2, 3.2.3, 3.3, 5.3.1, 5.4.4, 5.4.6, 5.4.7, 5.5.3, 7.2.1, 7.2.2, Appendix 3.1, Appendix 3.2, Appendix 3.3</p>
Mar. 2011	L(NA)08043ENG-F	<p>Addition of modules to be replaced</p> <p>QX41-S2, QX81-S2, QX21L, QY11AL</p> <p>Change of modules to be replaced</p> <p>Q61P-A1/A2 Q61P</p> <p>Addition</p> <p>CONDITIONS OF USE FOR THE PRODUCT, Upgrade tool (conversion adapter for analog module and high-speed counter module), Section 1.1, 1.1.2(4)(point), 7.6.3, 7.7.7(point)</p> <p>Partial correction</p> <p>SAFETY PRECAUTIONS, Section 1.2.2, 1.2.3, 2.1, 2.3.3, 2.4.1, 2.4.4, 2.4.5, Chapter 3 (whole), Chapter 4 (whole), Section 5.1, 5.2 (whole), 5.4.2, 5.4.4, 5.4.5, 5.5 (whole), 5.6 (whole), 7.1 (whole), 7.2 (whole), 7.3 (whole), 7.4, 7.4.2, 7.5, 7.5.2, 7.6.2, 7.7.1, 7.7.3, 7.7.9, Appendix 3.1, WARRANTY</p>

Print Date	* Handbook Number	Revision
Mar. 2012	L(NA)08043ENG-G	<p><u>Addition of modules to be replaced</u> Universal model QCPU, QY51PL</p> <p><u>Addition</u> GENERIC TERMS AND ABBREVIATIONS, Section 7.6.3, 7.6.4</p> <p><u>Partial correction</u> Section 1,1, 1.1.2, Chapter 2 (whole), Section 3.2 (whole), 4.1, 4.2, 5.1, 5.2 (whole), 5.4.5, 5.5.2, 5.6.1, 5.6.3, 5.6.5, Chapter 7, Section 7.1.2, 7.1.4, 7.2 (whole), 7.3 (whole), 7.4 (whole), 7.5 (whole), 7.6.2, 7.6.3, 7.7.1, 7.7.4, 7.7.6, 7.7.10, 7.7.11, 7.7.12, Appendix 3.3</p> <p><u>Partial deletion</u> Section 7.4.3, 7.5.3</p>
Mar. 2015	L(NA)08043ENG-H	<p>Revision on the new models and functions of the Universal model QCPU</p> <p><u>Addition of modules to be replaced</u> QA1S51B, Q03UDVCP, Q04UDVCP, Q06UDVCP, Q13UDVCP</p> <p><u>Addition</u> Section 7.1.5, 8.1.2</p> <p><u>Change</u> Chapter 8 → Appendix 1, Appendix1 → Appendix 2, Appendix 2 → Appendix 3, Appendix 3 → Appendix 4</p> <p><u>Partial correction</u> SAFETY PRECAUTIONS, Section 1.1, 1.1.2, 3.1, 3.2, 3.2.2, 3.4, 5.1, 5.3, 5.4, 5.4.1, 5.4.2, 5.4.4, 5.4.5, 5.4.7, 7.1.2</p>
Feb. 2016	L(NA)08043ENG-I	<p><u>Partial correction</u> SAFETY PRECAUTIONS, Section 1.2.2, 3.1, 3.2.1, 5.6.2, WARRANTY</p>
Jul. 2018	L(NA)08043ENG-J	<p><u>Change</u> Appendix 3 → Appendix 2, Appendix 4 → Appendix 3</p> <p><u>Partial correction</u> Cover, GENERIC TERMS AND ABBREVIATIONS, Chapter 1, 2, Section 4.2, Chapter 5, 6, 7</p> <p><u>Deletion</u> Appendix 2</p>
Feb. 2019	L(NA)08043ENG-K	<p><u>Partial correction</u> Section 3.1, 3.2</p>
Mar. 2021	L(NA)08043ENG-L	<p><u>Partial correction</u> Cover, Section 1.2.2, 5.5, 5.6</p>
Mar. 2021	L(NA)08043ENG-M	<p><u>Partial correction</u> Back cover</p>

Japanese Handbook Version L08042-R

This handbook confers no industrial property rights or any rights of any other kind, nor does it confer any patent licenses. Mitsubishi Electric Corporation cannot be held responsible for any problems involving industrial property rights which may occur as a result of using the contents noted in this handbook.

© 2005 MITSUBISHI ELECTRIC CORPORATION

CONTENTS

SAFETY PRECAUTIONS	A - 1
CONDITIONS OF USE FOR THE PRODUCT	A - 10
REVISIONS	A - 11
CONTENTS	A - 13
GENERIC TERMS AND ABBREVIATIONS	A - 18

CHAPTER 1 INTRODUCTION **1 - 1 to 1 - 16**

1.1 Considerations before Selection of Alternative Models for Replacement	1 - 1
1.2 Suggestions for Transition from the A/QnA (Large Type) Series to the Q Series	1 - 3
1.2.1 Advantages of transition to Q series	1 - 3
1.2.2 Suggestions for transition to Q series	1 - 4
1.2.3 Precautions for transition from large-sized A/QnA series to Q series	1 - 16

CHAPTER 2 CPU MODULE REPLACEMENT **2 - 1 to 2 - 23**

2.1 List of Alternative CPU Module Models for Replacement	2 - 1
2.2 CPU Module Specifications Comparisons	2 - 9
2.3 CPU Module Functional Comparisons	2 - 13
2.3.1 Functional comparisons between A2CCPU, AnNCPU and Q series CPU modules	2 - 13
2.3.2 Functional comparisons between AnACPU, AnUCPU and Q series CPU modules	2 - 15
2.3.3 Functional comparison between QnACPU and Q series CPU	2 - 17
2.4 Precautions for CPU Module Replacement	2 - 19
2.4.1 Memory for CPU module	2 - 19
2.4.2 Keyword registration and password registration	2 - 20
2.4.3 Write during RUN	2 - 21
2.4.4 No. of base unit I/O slots	2 - 21
2.4.5 Programming tool and connection cable for Q series CPU	2 - 23

CHAPTER 3 REPLACING I/O MODULES **3 - 1 to 3 - 180**

3.1 List of Alternative I/O Module Models	3 - 1
3.1.1 List of alternative Q series standard type module models	3 - 1
3.1.2 List of alternative Q series large type module models	3 - 26
3.2 I/O Module Specifications Comparison	3 - 28
3.2.1 Input module specifications comparison	3 - 28
3.2.2 Output module specifications comparison	3 - 100
3.2.3 I/O combined module specifications comparison	3 - 156
3.2.4 Interrupt module specifications comparison	3 - 162
3.2.5 Blank cover and dummy module specifications comparison	3 - 164
3.3 Precautions for I/O Module Replacement	3 - 165
3.4 Q Series Large Type I/O Module Replacement	3 - 167
3.4.1 Q series large type I/O module specifications comparison	3 - 167
3.4.2 Precautions for using the Q series large type I/O module	3 - 180

CHAPTER 4 POWER SUPPLY MODULE REPLACEMENTS **4 - 1 to 4 - 14**

4.1	List of Alternative Models for Power Supply Module	4 - 1
4.2	Power Supply Module Specifications Comparisons	4 - 3
4.3	Precautions for Power Supply Module Replacement	4 - 14

CHAPTER 5 BASE UNIT AND EXTENSION CABLE REPLACEMENT **5 - 1 to 5 - 24**

5.1	List of Alternative Models for Base Unit and Extension Cable	5 - 1
5.1.1	List of alternative models for base unit	5 - 1
5.1.2	List of alternative models for Q series large type base unit	5 - 2
5.1.3	List of alternative models for extension cable	5 - 2
5.2	Base Unit and Extension Cable Specifications Comparison	5 - 3
5.2.1	Base unit specifications comparison	5 - 3
5.2.2	Comparison of extension cable specifications	5 - 6
5.3	Precautions for Base Unit and Extension Cable Replacement	5 - 7
5.3.1	Precautions for base unit replacement	5 - 7
5.3.2	Precautions for replacement of extension cable	5 - 8
5.4	Q Series Large Type Base Unit Replacement	5 - 9
5.4.1	Specifications of Q series large type base unit	5 - 9
5.4.2	Applicable programmable controller	5 - 9
5.4.3	Modules that cannot be mounted on the Q series large type base unit	5 - 10
5.4.4	Precautions for Q series large type base unit replacement	5 - 11
5.5	QA(1S) Extension Base Unit	5 - 12
5.5.1	QA(1S) extension base unit specifications	5 - 12
5.5.2	Applicable QCPU	5 - 12
5.5.3	Extension cable	5 - 13
5.5.4	System configuration	5 - 13
5.5.5	System equipment list	5 - 15
5.5.6	I/O address for the QA(1S) extension base unit and QA conversion adapter	5 - 17
5.6	A-A1S Module Conversion Adapter	5 - 19
5.6.1	System configuration	5 - 19
5.6.2	Modules which can use the A-A1S module conversion adapter (A1ADP)	5 - 20
5.6.3	Precautions for using A-A1S module conversion adapter (A1ADP)	5 - 23

CHAPTER 6 MEMORY AND BATTERY REPLACEMENT **6 - 1 to 6 - 2**

6.1	List of Alternative Models for Memory	6 - 1
6.2	Precautions for Memory and Battery Replacement	6 - 2

7.1	Program Replacement Procedure	7 - 4
7.1.1	Program conversion procedure from ACPU to QCPU	7 - 4
7.1.2	Changing programmable controller type	7 - 5
7.1.3	ACPU program conversion ratio	7 - 8
7.1.4	Reading (Reusing) other format files	7 - 10
7.1.5	How to reuse a program of a PLC type that does not support GX Developer	7 - 15
7.2	Instruction Conversion	7 - 17
7.2.1	List of instructions conversion from ACPU to QCPU (Sequence/Basic/Application instructions)	7 - 17
7.2.2	List of instruction conversion from ACPU to QCPU (Dedicated instructions)	7 - 22
7.2.3	Instructions that may need a replacement at instruction conversion from ACPU to QCPU ...	7 - 25
7.2.4	Instruction conversion from QnACPU to QCPU	7 - 29
7.2.5	Instructions that may need a replacement after conversion from QnACPU to QCPU	7 - 29
7.3	Precautions for Parameter Replacement	7 - 31
7.3.1	Conversion from ACPU to QCPU	7 - 31
7.3.2	Conversion from QnACPU to QCPU	7 - 32
7.4	Special Relay Replacement	7 - 34
7.4.1	Replacing the ACPU with the QCPU	7 - 34
7.4.2	Replacing the QnACPU with the QCPU	7 - 34
7.5	Special Register Replacement	7 - 35
7.5.1	Replacing the ACPU with the QCPU	7 - 35
7.5.2	Replacing the QnACPU with the QCPU	7 - 35
7.6	Precautions for Replacing the MELSAP-II with the MELSAP3	7 - 36
7.6.1	Starting SFC program	7 - 36
7.6.2	Block information (SFC information device)	7 - 36
7.6.3	Specifications comparison between MELSAP-II and MELSAP3	7 - 37
7.6.4	Specifications comparison of MELSAP3 between QnACPU and QCPU	7 - 38
7.6.5	SFC diagram that cannot be read normally in another format	7 - 39
7.7	Precautions for Program Replacement	7 - 40
7.7.1	List of applicable devices	7 - 40
7.7.2	I/O control method	7 - 43
7.7.3	Usable data format for instructions	7 - 43
7.7.4	Timer	7 - 44
7.7.5	Counter	7 - 45
7.7.6	Display instructions	7 - 45
7.7.7	Index register	7 - 46
7.7.8	Instructions where format is changed (Excluding AnACPU/AnUCPU dedicated instructions)	7 - 47
7.7.9	AnACPU/AnUCPU dedicated instruction	7 - 48
7.7.10	Setting method when multiple sequence programs are created	7 - 49
7.7.11	Precautions for file register replacement	7 - 52
7.7.12	Boot run method (Writing programs to ROM)	7 - 53

APPENDICES**App - 1 to App - 7**

Appendix 1 External Dimensions	App - 1
Appendix 2 Spare Parts Storage	App - 1
Appendix 3 Related Manuals	App - 2
Appendix 3.1 Materials for replacement	App - 2
Appendix 3.2 A/QnA series	App - 3
Appendix 3.3 Q series	App - 5
Appendix 3.4 Programming tool	App - 6
Appendix 3.5 Products manufactured by Mitsubishi Electric Engineering Co., Ltd.	App - 7
Appendix 3.6 Products manufactured by Mitsubishi Electric System & Service Co., Ltd	App - 7

- For the products shown in handbooks for transition, Catalogue, and transition examples, refer to the manuals for the relevant products and check the detailed specifications, precautions for use, and restrictions before replacement.

For the products manufactured by Mitsubishi Electric Engineering Co., Ltd., Mitsubishi Electric System & Service Co., Ltd., and other companies, refer to the catalogue for each product and check the detailed specifications, precautions for use, and restrictions before use.

The manuals and catalogues for our products, products manufactured by Mitsubishi Electric Engineering Co., Ltd., and Mitsubishi Electric System & Service Co., Ltd., are shown in Appendix of each handbook for transition.

- For details on product compliance with the above standards, please contact your local Mitsubishi Electric sales office or representative.
- Products shown in this handbook are subject to change without notice.

GENERIC TERMS AND ABBREVIATIONS

Unless otherwise specified, this handbook uses the following generic terms and abbreviations.

Generic term/abbreviation	Description
■Series	
A series	An abbreviation for large types of Mitsubishi Electric MELSEC-A series programmable controllers
AnS series	An abbreviation for compact types of Mitsubishi Electric MELSEC-A series programmable controllers
A/AnS series	Generic term for A series and AnS series
QnA series	An abbreviation for large types of Mitsubishi Electric MELSEC-QnA series programmable controllers
QnAS series	An abbreviation for compact types of Mitsubishi Electric MELSEC-QnA series programmable controllers
A/QnA series	Generic term for A series and QnA series
AnS/QnAS series	Generic term for AnS series and QnAS series
QnA/QnAS series	Generic term for QnA series and QnAS series
A/AnS/QnA/QnAS series	Generic term for A series, AnS series, QnA series, and QnAS series
Q series	An abbreviation for Mitsubishi Electric MELSEC-Q series programmable controllers
■CPU module type	
CPU module	Generic term for A series, AnS series, QnA series, QnAS series, and Q series CPU modules
Process CPU	Generic term for the Q02PHCPU, Q06PHCPU, Q12PHCPU, and Q25PHCPU
Redundant CPU	Generic term for the Q12PRHCPU and Q25PRHCPU
Universal model QCPU	Generic term for the Q00UJCPU, Q00UCPU, Q01UCPU, Q02UCPU, Q03UDCPU, Q03UDVCPU, Q03UDECPU, Q04UDHCPU, Q04UDVCPU, Q04UDEHCPU, Q06UDHCPU, Q06UDVCPU, Q06UDEHCPU, Q10UDHCPU, Q10UDEHCPU, Q13UDHCPU, Q13UDVCPU, Q13UDEHCPU, Q20UDHCPU, Q20UDEHCPU, Q26UDHCPU, Q26UDVCPU, and Q26UDEHCPU
■CPU module model	
ACPU	Generic term for MELSEC-A series CPU modules
AnSCPU	Generic term for MELSEC-AnS series CPU modules
AnNCP	Generic term for the A1NCP, A1NCPUP21/R21, A1NCPUP21-S3, A2NCP, A2NCP-S1, A2NCPUP21/R21, A2NCPUP21/R21-S1, A2NCPUP21-S3(S4), A3NCP, A3NCPUP21/R21, and A3NCPUP21-S3
AnACPU	Generic term for the A2ACPU, A2ACPU-S1, A3ACPU, A2ACPUP21/R21, A2ACPUP21/R21-S1, and A3ACPUP21/R21
AnUCPU	Generic term for the A2UCPU, A2UCPU-S1, A3UCPU, and A4UCPU
AnUS(H)CPU	Generic term for the A2USCPU, A2USCPU-S1, and A2USHCPU-S1
A/AnSCPU	Generic term for the ACP and AnSCP
AnN/AnACPU	Generic term for the AnNCP and AnACP
AnN/AnA/AnSCPU	Generic term for the AnNCP, AnACP, and AnSCP
QnACPU	Generic term for MELSEC-QnA series CPU modules
QnASCPU	Generic term for MELSEC-QnAS series CPU modules
QnA/QnASCPU	Generic term for the QnACP and QnASCP
A/AnS/QnA/QnASCPU	Generic term for the ACP, AnSCP, QnACP, and QnASCPs
QCPU	Generic term for MELSEC-Q series CPU modules

1 INTRODUCTION

1.1 Considerations before Selection of Alternative Models for Replacement

This transition handbook describes the model selection of CPU modules and I/O modules after replacing models, for the transition from the MELSEC-A/QnA (large type) series to the Q series. At the transition from MELSEC-A/QnA (large type) series to Q series, some items such as the replacement procedure, installation location, specifications comparisons between existing modules and replaced modules, and replacement method are required to be considered beforehand. The following shows major options. Consider them sufficiently in advance. (It is necessary to understand the existing system configuration before making considerations.)

(Major items required to be considered in advance)

1) Replacement methods and installation location

- a) Whether gradual replacement (only the CPU module is replaced with Q series, etc.) or batch replacement for the replacement method of the existing system. When replacing it gradually, which existing modules should be leveraged (left).
- b) Whether some space can be reserved when adding a base unit at the replacement work.

2) Replacement schedule

3) Model selection after replacing models (I/O module)

- a) Whether a module whose specifications (rated input current, etc.) and functions are equivalent to that of the existing module exists or not in the Q series.
- b) Whether utilizing the existing modules continuously or replacing them with Q series modules.
- c) Whether utilizing the existing external wiring or wiring newly.

4) Model selection after replacing models (intelligent function module (analog, high-speed counter module, etc))

- a) Whether the specifications of replaced modules and connection external device match or not.

5) Model selection after replacing models (communication module (computer link module, Ethernet module etc))

- a) Whether the communication target device is compatible with the Q series module commands in the communication using the MC protocol or not.
- b) Whether the communication target device software (program) can be changed to Q series CPU-compatible or not.

6) Model selection after replacing models (network module (MELSECNET (II), MELSECNET/MINI(-S3)))

- a) Whether the replacement of MELSECNET (II) is a gradual replacement or batch replacement for.
- b) Whether local stations and remote stations can be grouped into two networks, PLC-to-PLC network and remote I/O network, by replacing to MELSECNET/H when the local stations and remote stations are mixed in the existing MELSECNET (II).
- c) Whether a new communication cable installation has been considered or not at the replacement from MELSECNET/MINI(-S3) to CC-Link.

7) Program utilization

- a) Whether utilizing the program in the existing system or creating a new program.
- b) Whether the workload and cost of correction have been considered or not when utilizing the program of intelligent function module and communication module (nonprocedural mode).

1.2 Suggestions for Transition from the A/QnA (Large Type) Series to the Q Series

1.2.1 Advantages of transition to Q series

(1) Advanced performance of equipments (Tact time reduction).

The Q series includes faster operation processing speed, faster bus speed and dual processors of Super MSP (MELSEC SEQUENCE PROCESSOR) and general-purpose processor to provide over 5 times more efficient processing than the A/QnA series. This realizes more advanced performance of equipments.

(2) Compact control panel and space saving

Comparing to the A/QnA series, the Q series requires one-fourth mounting area, which allows installing compacter control panel.

(3) Improved maintainability

- (a) The high-speed program ports (Ethernet port, USB port, and high-speed serial port) enable the program reading/writing time to be greatly reduced, resulting in improvement of on-site maintainability.
- (b) The Universal model QCPU does not require the ROM operation because the program memory is the flash ROM.
- (c) As large files can be managed, it is possible to store conventional programs as correction history in memory.

(4) Easy support for information systems

- (a) The Web server module, MES interface module, and high speed data logger module can perform remote monitoring of programmable controller CPUs and perform data collection for quality control and traceability. Information can be easily gathered from the factory using a Web server module once transition from AnS/QnAS series to Q series has been completed.

1.2.2 Suggestions for transition to Q series

(1) Leveraging the Q series large type base unit and Q series large type I/O module

Method: Using the Q series large type base unit and Q series large type I/O module*¹, attach the 32-point terminal block used for existing A series I/O module without changing external wiring.

Advantage: Changing the existing external wiring and processing the mounting hole of the Q series large type base unit are unnecessary. Moreover, Q series modules are mountable.

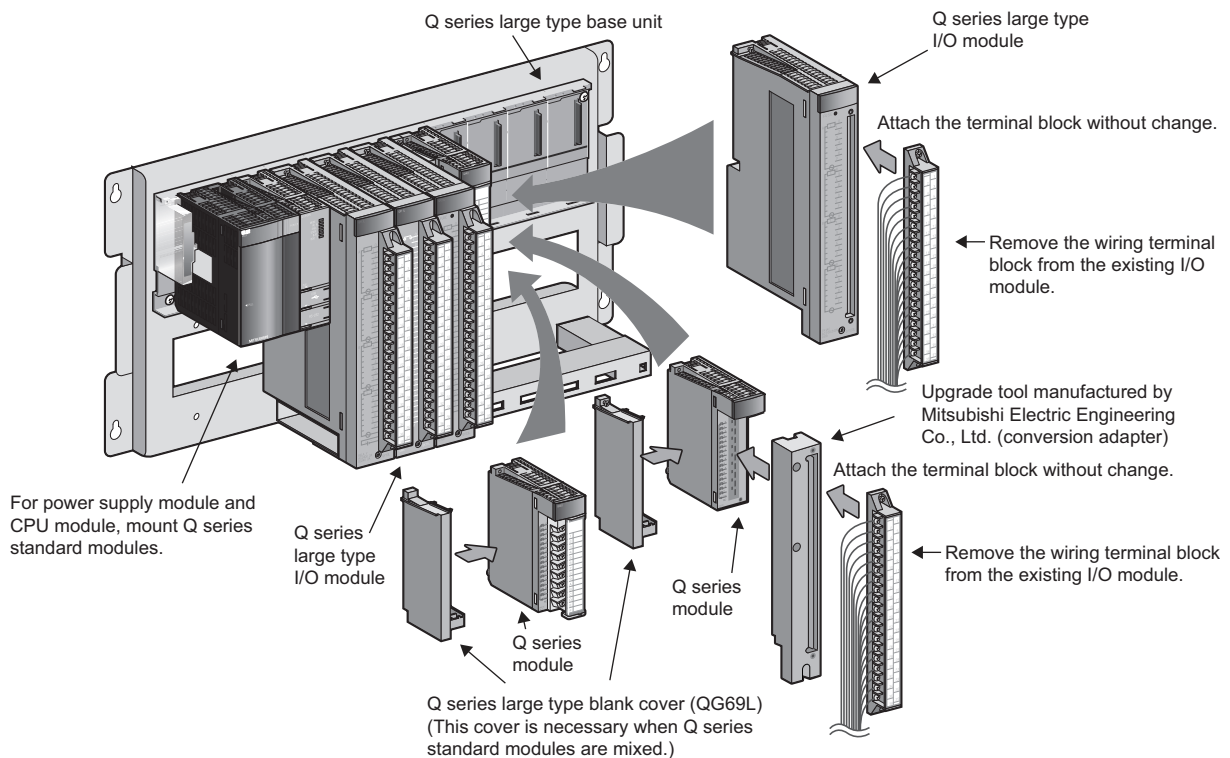

- The 32-point terminal block used for the A/QnA series can be attached to the Q series large type I/O module without changing external wiring. This permits eliminating wiring change when replacing the A/QnA series.
- The Q series large type I/O module has performance specifications equivalent to the A/QnA series.
- Since the A/QnA series base unit has the same mounting dimensions with the Q series large type base unit, the mounting holes can be utilized.
- The Q series large type I/O module and Q series module can be mounted together on the Q series large type base unit.
The upgrade tool*² manufactured by Mitsubishi Electric Engineering Co., Ltd. (hereafter, abbreviated as upgrade tool) can be mounted on the Q series module, and a connector and terminal block used with the A/QnA series can be used without wiring change. (Refer to the figure above.)

*1 For details of the Q series large type base unit, refer to Section 5.4 and for details of the Q series large type I/O module, refer to Section 3.4.

*2 For products manufactured by Mitsubishi Electric Engineering Co., Ltd., contact your local sales representative.

(2) Transition to Q series by utilizing existing wiring

Method: Use the upgrade tool manufactured by Mitsubishi Electric Engineering Co., Ltd and the existing mounting hole/terminal block wiring.

Advantage: No need to process additional holes, and the existing wiring is usable.

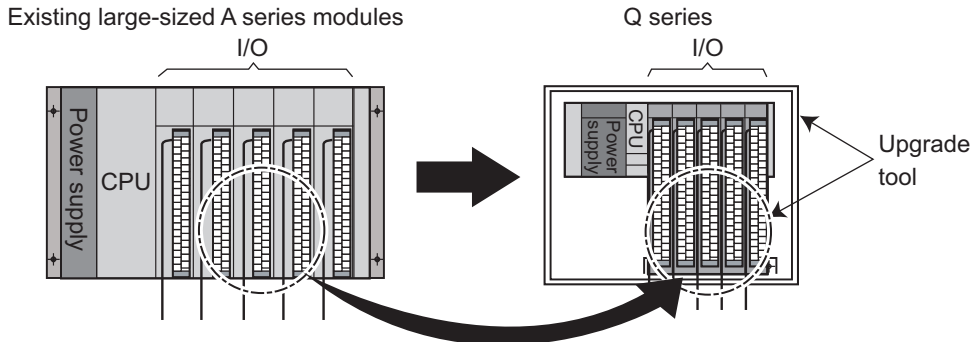

Remove the existing terminal block (with wiring) and mount it onto the upgrade tool (base adapter).

Remarks

Upgrade tool for transition from the A series to the Q series released from Mitsubishi Electric Engineering Co., Ltd. is composed of the following products.

- (1) Conversion adapter for changing the existing wiring connected to the A series I/O module to wiring for the Q series I/O module
- (2) Conversion adapter fixing stand for fixing the bottom of the conversion adapter
- (3) Base adapter which utilizes the mounting hole of the A series base unit for mounting Q series module

For example, using the conversion adapter allows utilizing the wiring connected to the A series I/O module for the Q series module without change. (32-point module terminal block for the A series can be attached to two Q series 16-point modules.)

Note that the conversion adapter cannot be mounted depending on the size of used wire. In that case, take measures such as making the left side slot empty.

For details, refer to the catalog of the upgrade tool.

Replacement procedures:

- (1) Remove the existing A series modules together with the base unit, and use the existing mounting holes to mount the upgrade tool (Base adapter) manufactured by Mitsubishi Electric Engineering Co., Ltd. Then mount the Q series. (By mounting the base adapter, it is not necessary to redo the mounting holes.)
- (2) Mount the upgrade tool (Conversion adapter) manufactured by Mitsubishi Electric Engineering Co., Ltd. on the mounted Q series I/O modules.
- (3) Remove the terminal blocks wired from the existing A series I/O modules, and mount the blocks on the conversion adapter. (The existing wiring is usable.)
- (4) To use I/O modules that the Q series does not support, the FA goods manufactured by Mitsubishi Electric Engineering Co., Ltd. are available.
- (5) Programs are automatically converted* by changing the programmable controller type from ACPUR to QCPU using GX Developer. Even if the module arrangement is changed, the I/O can be assigned to the same number as before, which cuts out the need to modify the programs and slot number for I/O module.

* Some instructions are not automatically converted. In case of intelligent function module or network module, programs and parameters need be changed

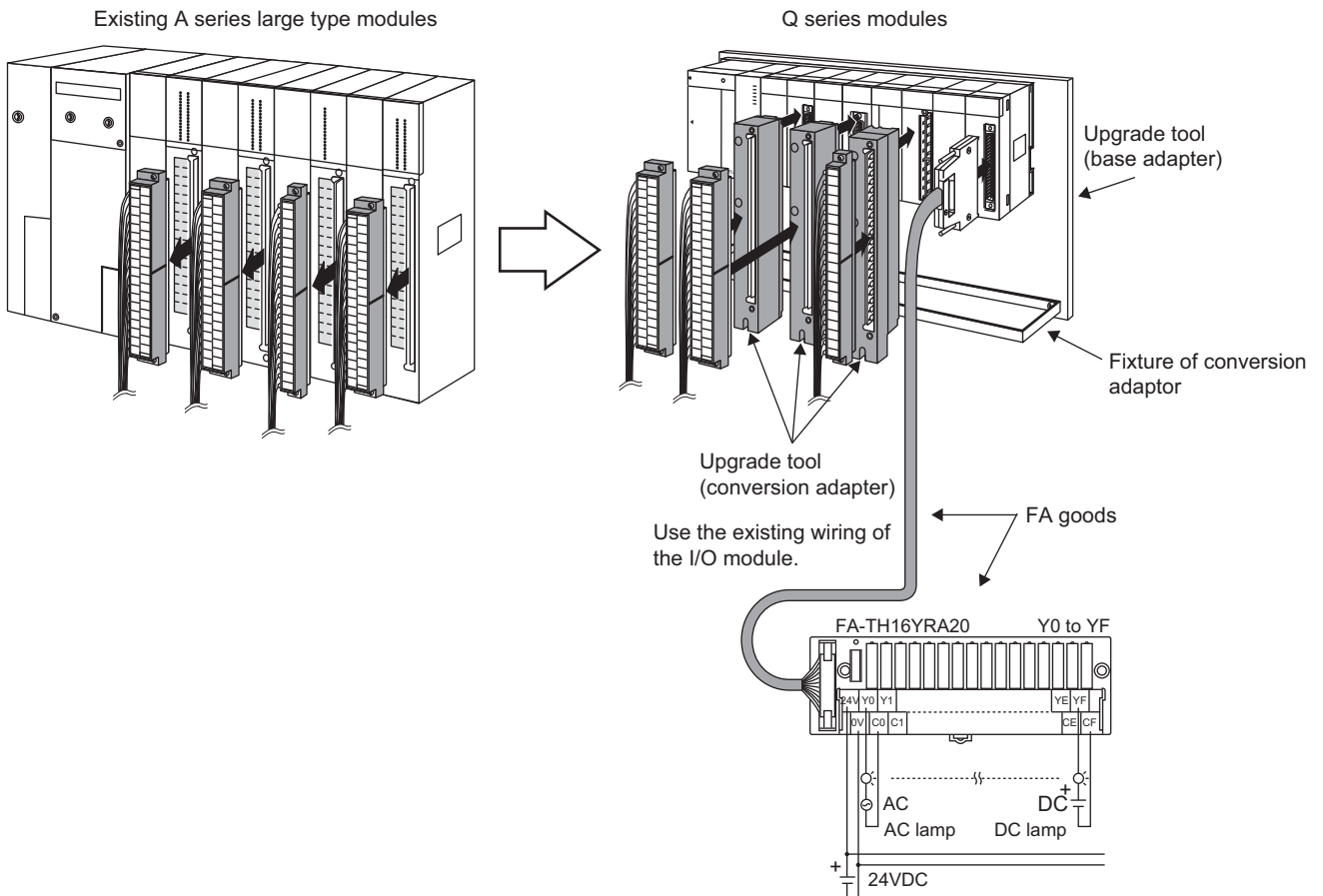

When an A series I/O module is replaced with a Q series I/O module, a conversion module and interface module can be used.

■ Upgrade tool list

(1) Base adapter

Model		Base adapter model	Fixture of conversion adapter			
A Series	Q Series		ERNT-AQF12	ERNT-AQF8	ERNT-AQF5	ERNT-AQF3
A38B, A38HB, A38B-UL	Q312B, Q312DB	ERNT-AQB38	○	○		
	Q38B, Q38DB	ERNT-AQB38		○		
A68B, A68B-UL	Q612B	ERNT-AQB68	○	○		
	Q68B	ERNT-AQB68		○		
A58B, A58B-UL	Q68B	ERNT-AQB58		○		
A35B, A35B-UL	Q38B, Q38DB	ERNT-AQB35		○	○	
	Q35B	ERNT-AQB35			○	
A65B, A65B-UL	Q68B	ERNT-AQB65		○	○	
	Q65B, Q55B	ERNT-AQB65			○	
A55B, A55B-UL	Q65B, Q55B	ERNT-AQB55			○	
A32B, A32B-UL	Q33B	ERNT-AQB32				○
A62B	Q63B, Q52B	ERNT-AQB62				○
A52B	Q52B	ERNT-AQB52				○

(2) Conversion adapter

(a) 1-slot type (Mountable to Q series large type base unit)

Separate adapters for I/O modules, analog modules, and high-speed modules are available respectively.

A conversion adapter (1-slot type) can be used with a Q series large type I/O module.

1) For I/O module

Product	Model		Conversion adapter model	Q series shape
	A series	Q series		
Input module	AX10, AX10-UL	QX10	ERNT-AQTX10	18-point terminal block
	AX40, AX40-UL	QX40, QX70	ERNT-AQTX40	
		QX40-S1		
	AX70, AX70-UL	QX70	ERNT-AQTX80	
	AX50, AX50-S1	QX50		
	AX80, AX80-UL	QX80		
	AX41, AX41-UL	QX41, QX41-S2, QX71	ERNT-AQTX41	40 pin connector
	AX31-S1	QX41, QX41-S2		
	AX41-S1	QX41-S1		
AX71	QX71			
	AX81, AX81-S1	QX81, QX81-S2	ERNT-AQTX81	37 pin D-sub connector
Output module	AY10	QY10	ERNT-AQTY10	18-point terminal block
	AY11, AY11-UL			
	AY11E			
	AY11EEU			
	AY22	QY22	ERNT-AQTY22	
	AY40, AY40P, AY40-UL	QY40P	ERNT-AQTY40	
	AY70, AY70-UL	QY70		
	AY50, AY50-UL	QY50	ERNT-AQTY50	
	AY80	QY80	ERNT-AQTY80	
	AY41, AY41P, AY41-UL	QY41P	ERNT-AQTY41	40 pin connector
	AY71	QY71		
	AY81, AY81EP	QY81P	ERNT-AQTY81	37 pin D-sub connector

2) For analog module/high-speed counter module

Product	Model		Conversion adapter model	Q series shape
	A series	Q series		
Analog input module	A68AD ^{*1}	Q68ADV Q68ADI	ERNT-AQT68AD	18-point terminal block
	A68AD-S2 ^{*1}			
	A68ADN ^{*1}		ERNT-AQT68ADN	
Analog output module	A62DA	Q62DAN	ERNT-AQT62DA	
	A62DA-S1			
	A68DAV	Q68DAVN	ERNT-AQT68DA	
	A68DAI			
	A68DAI-S1			
High-speed counter module	AD61	QD62-H01	ERNT-AQTD61	40 pin connector
	AD61-S1	QD62-H02		

*1 Voltage input or current input for the replacing Q series module. When using the existing A series module with voltage/current mixed input, the replacement with the Q series large type base unit and conversion adapter is not possible. Consider the replacement to the Q64AD-GH (using two modules) by leveraging the 2-slot type conversion adapter.

(b) 2-slot type (Not mountable to Q series large type base unit)

1) For I/O module

Product	Model		Conversion adapter (2-slot type)		
	A series	Q series	Model	A series shape	Q series shape
Input	AX11 ^{*1}	QX10 × 2 modules	ERNT-AQTX11	38-points terminal block	18-points terminal block × 2 modules
	AX11EU ^{*1}				
Output	AY10A, AY10A-UL ^{*2}	QY18A × 2 modules	ERNT-AQTY10A		
	AY11A ^{*2}				
	AY11AEU ^{*2}				
	AY13 ^{*3}	QY10 × 2 modules	ERNT-AQTY13		
	AY13E ^{*3}				
	AY13EU ^{*3}				
	AY23 ^{*4}	QY22 × 2 modules	ERNT-AQTY23		
	AY51, AY51-UL ^{*5}	QY50 × 2 modules	ERNT-AQTY51		
	AY51-S1 ^{*5}				
AY81					
AY81EP	QY80 × 2 modules				

- *1 Replaceable with Q Series large type input module QX11L
- *2 Replaceable with Q Series large type output module QY11AL
- *3 Replaceable with Q Series large type output module QY13L
- *4 Replaceable with Q Series large type output module QY23L
- *5 Replaceable with Q Series large type output module QY51PL

2) For analog module

Product	Model		Conversion adapter (2-slot type)		
	A series	Q series	Model	A series shape	Q series shape
Input	A68AD (Voltage/Current mixed input)	Q64AD-GH × 2 modules ^{*6}	ERNT-AQT68AD-GH	38-points terminal block	18-points terminal block × 2 modules
	A68AD-S2 (Voltage/Current mixed input)				
	A68ADN (Voltage/Current mixed input)				
	A616AD (Voltage input)	Q68ADV × 2 modules	ERNT-AQT616AD		
	A616AD (Current input)	Q68ADI × 2 modules			
Output	A616DAV	Q68DAVN × 2 modules	ERNT-AQT616DA		
	A616DAI	Q68DAIN × 2 modules			

*6 When using mixed voltage/current input for existing A series module.

The 1-slot type conversion adapter can be used when using voltage input only or current input only.

(c) Universal conversion adapter (Mountable to Q series large type base unit)

A screw terminal block and conversion adapter are included in the universal conversion adapter.

When the module which does not support the conversion adapter is replaced, the solderless terminal can be used and rewiring can be reduced. However, the wiring change is required.

Product	Model		Universal conversion adapter ^{*1}		
	A series	Q series	Model	A series shape	Q series shape
Input	AX20(-UL)	QX28 × 2 modules	ERNT-AQTB20 ^{*2}	20-points terminal block	18-points terminal block × 2 modules
	AX21(EU)	QX28 × 4 modules		38-points terminal block	18-points terminal block × 4 modules
	AX80 AX80E	QX70		20-points terminal block	18-points terminal block
	AX81 AX81-S1	QX71	ERNT-AQTB38 ^{*2}	38-points terminal block	40 pin connector
	AX31	QX41, QX71			
	Output	AY20EU	QY22	ERNT-AQTB20-S1 ^{*2}	38-points terminal block
AY40A AY60 AY60E AY60EP AY60S(-UL)		QY68A × 2 modules	ERNT-AQTB20 ^{*2}	38-points terminal block	18-points terminal block × 2 modules
AY60E				20-points terminal block	
AY60EP					
AY60S(-UL)					
AY15EU				QY10 × 2 modules	

*1 All terminal blocks included the universal conversion adapter are 38 points.

*2 The universal conversion adapter is required the number of replaced Q series modules.

Compatibility of Q series large type base unit with the upgrade tool

The following table shows the compatibility of Q series large type base unit with the upgrade tool manufactured by Mitsubishi Electric Engineering Co., Ltd. when replacing existing A/QnA series modules with Q series modules.

○: Applicable (Mountable), △: Applicable with restrictions (Mountable), ×: Not Applicable (Not mountable)

Item		Q series large type base unit ^{*1}	Base adapter Conversion adapter (upgrade tool) ^{*2}
Slot width of base unit ^{*3}		Same width as the A Series base unit (37.5 mm)	Same width as Q Series base unit (27.4 mm)
Mountable module	Power supply module	Q Series standard power supply module	○
	CPU module	Universal model QCPU	○ ^{*4}
		Universal model Process CPU	×
		Process CPU	×
	• I/O module • Intelligent function module	Redundant CPU	×
		Q Series large type I/O modules ^{*5}	○
		Q Series module (occupies 1 slot)	○ ^{*7}
Q Series module (occupies 2 slots)	×		
Conversion adapter ^{*6}	For terminal block type 16-point I/O module (occupies 1 slot)	○ ^{*7}	○
	For terminal block type 32-point I/O module (occupies 1 slot)	○ ^{*7}	△ ^{*9}
	For terminal block type 32-point I/O module (occupies 2 slots)	×	△ ^{*10}
	For high-speed counter module	○ ^{*7}	△ ^{*9}
	For analog module (occupies 1 slot)	○ ^{*7}	△ ^{*9}
	For analog module (occupies 2 slots)	×	△ ^{*10}
Connection of QA/QA1S extension base unit ^{*8}		○	○

*1 Q series large type base units can be used with Q series base units (standard products).

*2 Mount a Q series base unit (standard product) on the base adapter manufactured by Mitsubishi Electric Engineering Co., Ltd.

*3 Check mounting conditions before using the upgrade tool, because wiring space is reduced because of a decrease in the module's width.

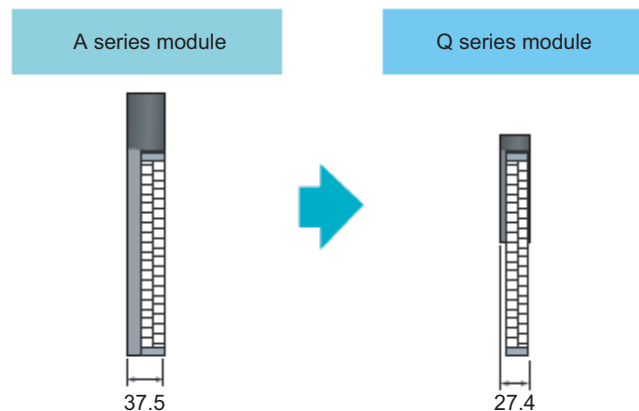

- *4 Q00JCPU is not compatible.
- *5 Number of common points and electrical specifications are same as that of A series I/O module.
- *6 Since the adapters are mounted on Q series modules, the specifications and functions are same as those of the Q series modules. (Please check the transition handbook, since the specifications and functions are different from those of A series module)
- *7 Q series large type blank cover (QG69L) is required.
- *8 Only Universal model QCPU whose serial number (first five digits) is "09012" or later can be connected to the QA/QA1S extension base unit.
- *9 If the size of the wire connected to the terminal block is larger than 1.25mm², ERNT-AQTX41, AQTY41, AQTX81, AQTY81, AQT68AD, AQT68ADN, AQT68DA, and AQTD61 modules may be difficult to mount.
In this case, secure wiring space by leaving empty slots in between modules. For example, mount modules on slot No. 0, 2, 4, 6, 8, and leave slot No. 1, 3, 5, 7 empty.

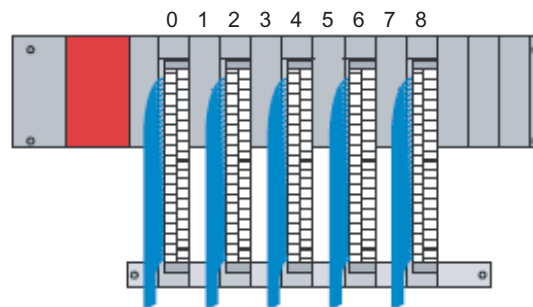

- *10 To be used when replacing the AY51 with two QY50 modules and a conversion adapter. Or, when replacing the A616AD with two Q68ADV(I) modules and a conversion adapter.
In both cases, the existing wired terminal blocks can be used.

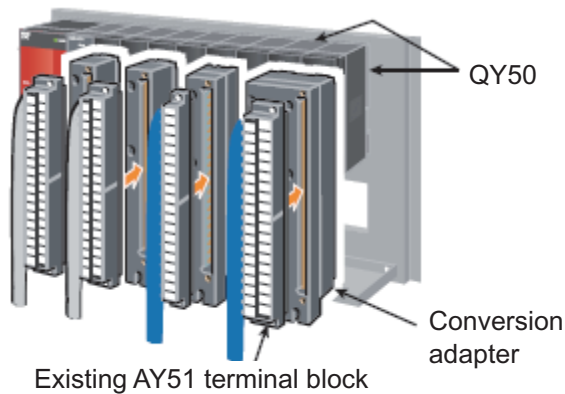

(3) Replacing the CPU module with the QCPU, and replacing existing modules with the Q series modules in series with using the existing A series module

Method : Replace the modules gradually by using the QA extension base unit (QA6□B) and utilizing the property of the A series.

Advantage: The cost and workload for the transition can be divided, and yet the function extension can be continued during the transition.

Notice QA extension base unit have been discontinued at the end of June 2020.
For details, refer to the technical bulletins (FA-A-0289).

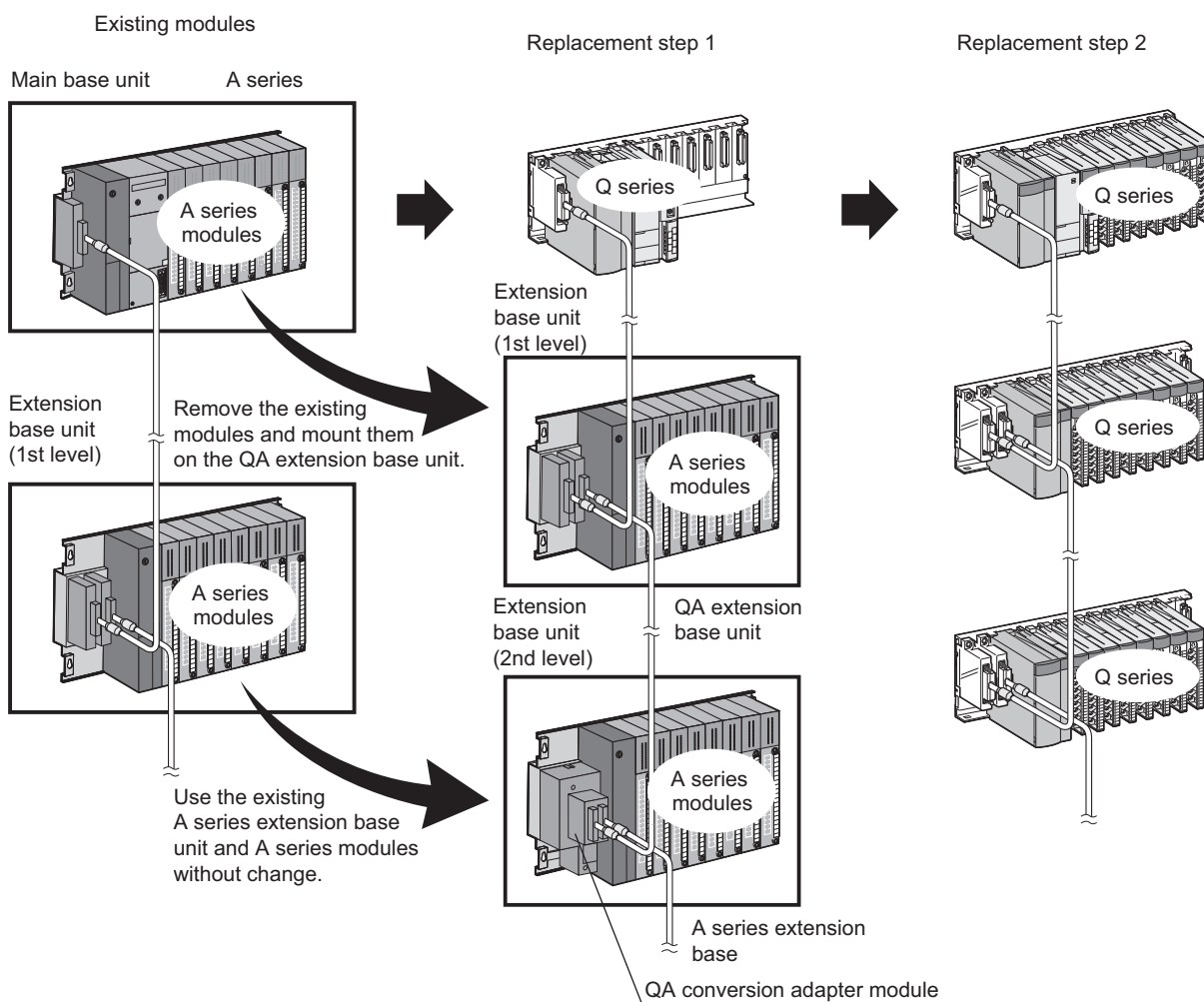

- (a) The QA extension base unit has the "QA6□B", supporting A series and the "QA1S51B" and "QA1S6□B", supporting AnS series.
When replacing the AnS/QnAS series, the AnS series module can be utilized.
The "QA1S51B" cannot be connected to an extension base unit. The "QA1S51B" cannot be used with the "QA6□B" or "QA6ADP+A5□B/A6□B", because the "QA1S51B" does not have the extension cable connector (OUT).
For details and precautions on the QA extension base unit, refer to Section 5.5.
- (b) By mounting the QA conversion adapter module, existing A series extension base unit can be used as the extension base unit for the replaced QCPU. (Since it is equivalent to the QA extension base unit, the precautions for the mountable module are the same as that of the QA extension base unit.)

- (c) When utilizing existing A series module using QA extension base, programs can be utilized without changing the existing I/O address with I/O assignment setting in PLC parameter. For details of I/O address setting method with I/O assignment, refer to Section 5.5.6.

Replacement procedures:

Step 1

- Mount the QCPU and a module for function expansion on the Q series main base unit. Connect the QA extension base unit (QA68B) to the main base unit as the first extension base unit and mount the power supply module and I/O module which are installed to the existing A series main base unit series on it. (Wiring change is unnecessary.) Mount the QA conversion adapter modules (QA6ADP) on after the first extension base units, and utilize the existing extension base unit, power supply module, and I/O module for A series to a system after replacement.

Step 2

Replace the existing modules mounted on the QA extension base unit and the A series extension base unit + QA conversion adapter module with the Q series modules in series. Remove the QA extension base unit and A series extension base unit after replacing all the modules.

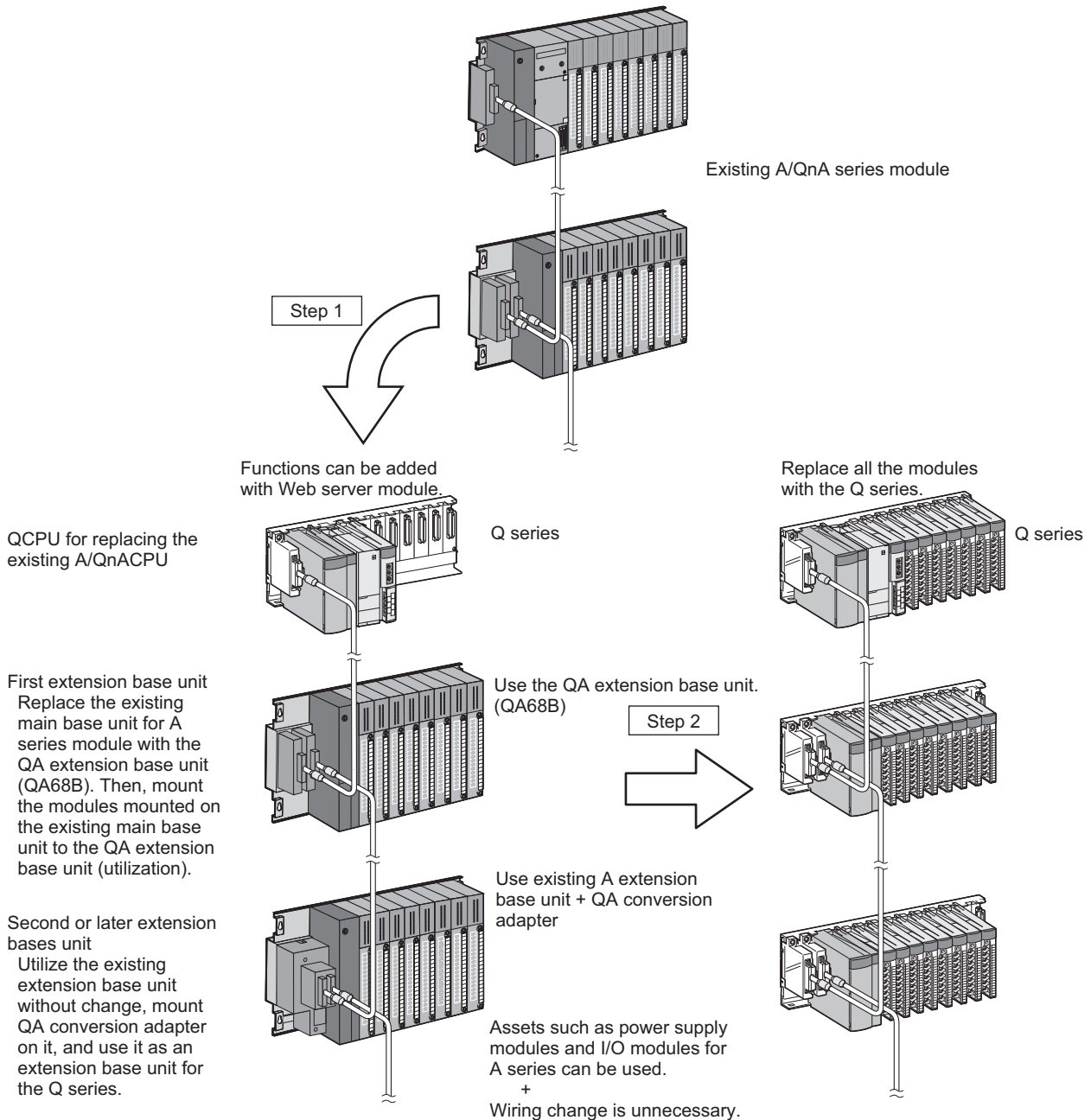

- Programs are automatically converted* by changing the programmable controller type from ACPUCPU to QCPU using GX Developer. When the existing modules are replaced with the High-speed Universal model QCPU, change "PLC Type" into "Universal model QCPU". Change "PLC Type" again after opening a program by "Other form project" on GX Works2. For details, refer to Section 7.1.4.

For MELSEC-A/QnA(large type) Series to Q Series transition related products manufactured by Mitsubishi Electric Engineering Co., Ltd. or Mitsubishi Electric System & Service Co., Ltd., contact your local sales office or representative.

1.2.3 Precautions for transition from large-sized A/QnA series to Q series

- (a) Before replacing the A/QnA series by the Q series, be sure to refer to manuals for each Q series module to check the functions, specifications, grounding method and usage.
- (b) For products manufactured by Mitsubishi Electric Engineering Co., Ltd. and Mitsubishi Electric System & Service Co., Ltd., refer to the catalog for each product shown in Appendix to develop an understanding of the detailed specifications, precautions and restrictions for use for correct usage.
- (c) After replacing the A/QnA series by the Q series, be sure to check operations of the whole system before the actual operation.

Point

Before replacement, make sure again that the frame ground of the programmable controller system is securely grounded.

The noise tolerance of programmable controllers is secured by diverting noise to ground via the frame ground as an EMC measure.

For this reason, the system might be affected by noise if the system is reconfigured with insufficient grounding.

Also, consider the following as a provisional measure when checking grounding status is difficult.

- (1) Change the ground of the system to an exclusive ground.
 - (2) Add a ferrite core between the ground wire and the module FG terminal.
-

2 CPU MODULE REPLACEMENT

2.1 List of Alternative CPU Module Models for Replacement

The following table lists alternative models of the Q series CPU module decided depending on the program capacity, number of I/O points, and functions of the A/QnA series CPU modules. Select the most suitable model in light of the control targets of the A/QnA series CPU module, specifications and extendability of a system after replacement, and cost.

A/QnA series models to be discontinued		Q series alternative models	
Product	Model	Model	Remarks (restrictions)
CPU module	A1NCPUR21*1 A1NCPUR21*1 A1NCPUP21-S3*1	Q00UCPU	1) I/O control: Refresh/Direct switching → Refresh only 2) Processing speed (LD instruction): For refresh 1.0μs → 0.08μs 3) PC MIX value: 0.2 → 7.36 4) Number of I/O points: 256 points → 1024 points 5) Number of I/O device points: 256 points → 8192 points 6) Program capacity: 6k steps → 10k steps 7) Number of file register points: 0 point → 64k points 8) Extension level: 1 → 4 9) Applicable memory: 4KRAM (Sold separately)/4KROM (Sold separately)/4KEROM (Sold separately) → Program memory/Standard RAM/Standard ROM 10) Micro computer program: Available → Not available
		Q01UCPU	1) I/O control: Refresh/Direct switching → Refresh only 2) Processing speed (LD instruction): For refresh 1.0μs → 0.06μs 3) PC MIX value: 0.2 → 9.79 4) Number of I/O points: 512 points → 1024 points 5) Number of I/O device points: 512 points → 8192 points 6) Program capacity: 14k steps → 15k steps 7) Number of file register points: 4k points → 64k points 8) Extension level: 3 → 4 9) Applicable memory: Depending on the memory cassette → Program memory/Standard RAM/Standard ROM 10) Micro computer program: Available → Not available
CPU module	A2NCPUR21*1 A2NCPUR21*1 A2NCPUP21-S3*1	Q02UCPU	1) I/O control: Refresh/Direct switching → Refresh only 2) Processing speed (LD instruction): For refresh 1.0μs → 0.04μs 3) PC MIX value: 0.2 → 14 4) Number of I/O points: 512 points → 2048 points 5) Number of I/O device points: 512 points → 8192 points 6) Program capacity: 14k steps → 20k steps 7) Number of file register points: 4k points → 64k points (Using memory card: 4086k points) 8) Extension level: 3 → 4 9) Applicable memory: Depending on the memory cassette → Program memory/Standard RAM/Standard ROM/memory card (Sold separately) 10) Micro computer program: Available → Not available

A/QnA series models to be discontinued		Q series alternative models	
Product	Model	Model	Remarks (restrictions)
CPU module	A2NCPUR21-S1 ^{*1} A2NCPUP21-S1 ^{*1} A2NCPUR21-S1 ^{*1} A2NCPUP21-S4 ^{*1}	Q01UCPU	<ol style="list-style-type: none"> 1) I/O control: Refresh/Direct switching → Refresh only 2) Processing speed (LD instruction): For refresh 1.0μs → 0.06μs 3) PC MIX value: 0.2 → 9.79 4) Number of I/O points: 1024 points → 1024 points 5) Number of I/O device points: 1024 points → 8192 points 6) Program capacity: 14k steps → 15k steps 7) Number of file register points: 4k points → 64k points 8) Extension level: 7 → 4 9) Applicable memory: Depending on the memory cassette → Program memory/Standard RAM/Standard ROM 10) Micro computer program: Available → Not available
		Q03UDVCPU/ Q03UD(E)CPU	<ol style="list-style-type: none"> 1) I/O control: Refresh/Direct switching → Refresh only 2) Processing speed (LD instruction): For refresh 1.0μs → 0.0019μs (Q03UDVCPU), 1.0μs → 0.0095μs (Q03UD(E)CPU) 3) PC MIX value: 0.2 → 227 (Q03UDVCPU)/28 (Q03UD(E)CPU) 4) Number of I/O points: 1024 points → 4096 points 5) Number of I/O device points: 1024 points → 8192 points 6) Program capacity: 14k steps → 30k steps 7) Number of file register points: 4k points → 96k points (Using an extended SRAM cassette for the Q03UDVCPU: 4192k points and using a memory card for the Q03UD(E)CPU: 4086k points) 8) Extension level: 7 → 7 9) Applicable memory: Depending on the memory cassette → Program memory/Standard RAM/Standard ROM/memory card^{*2} (Sold separately) 10) Micro computer program: Available → Not available
CPU module	A3NCPUR21-S1 ^{*1} A3NCPUP21-S1 ^{*1} A3NCPUR21-S3 ^{*1}	Q02UCPU	<ol style="list-style-type: none"> 1) I/O control: Refresh/Direct switching → Refresh only 2) Processing speed (LD instruction): For refresh 1.0μs → 0.04μs 3) PC MIX value: 0.2 → 14 4) Number of I/O points: 2048 points → 2048 points 5) Number of I/O device points: 2048 points → 8192 points 6) Program capacity: 30k × 2 steps → 20k steps 7) Number of file register points: 8k points → 64k points (Using memory card: 4086k points) 8) Extension level: 7 → 4 9) Applicable memory: Depending on the memory cassette → Program memory/Standard RAM/Standard ROM/memory card^{*2} (Sold separately) 10) Micro computer program: Available → Not available
		Q06UDVCPU/ Q06UD(E)HCPU	<ol style="list-style-type: none"> 1) I/O control: Refresh/Direct switching → Refresh only 2) Processing speed (LD instruction): For refresh 1.0μs → 0.0019μs (Q06UDVCPU), 1.0μs → 0.0095μs (Q06UD(E)HCPU) 3) PC MIX value: 0.2 → 227 (Q06UDVCPU)/60 (Q06UD(E)HCPU) 4) Number of I/O points: 2048 points → 4096 points 5) Number of I/O device points: 2048 points → 8192 points 6) Program capacity: 30k × 2 steps → 60k steps 7) Number of file register points: 8k points → 384k points (Using an extended SRAM cassette for the Q06UDVCPU: 4480k points and using a memory card for the Q06UD(E)HCPU: 4086k points) 8) Extension level: 7 → 7 9) Applicable memory: Depending on the memory cassette → Program memory/Standard RAM/Standard ROM/memory card^{*2} (Sold separately) 10) Micro computer program: Available → Not available

A/QnA series models to be discontinued		Q series alternative models	
Product	Model	Model	Remarks (restrictions)
CPU module	A2ACPU A2ACPUP21* ¹ A2ACPUR21* ¹ A2ACPUP21-S3* ¹	Q01UCPU	<ol style="list-style-type: none"> 1) I/O control: Refresh only 2) Processing speed (LD instruction): 0.2μs → 0.06μs 3) PC MIX value: 0.9 → 9.79 4) Number of I/O points: 512 points → 1024 points 5) Number of I/O device points: 512 points → 8192 points 6) Program capacity: 14k steps → 15k steps 7) Number of file register points: 8k points → 64k points 8) Extension level: 3 → 4 9) Applicable memory: Depending on the memory cassette → Program memory/Standard RAM/Standard ROM
		Q02UCPU	<ol style="list-style-type: none"> 1) I/O control: Refresh only 2) Processing speed (LD instruction): 0.2μs → 0.04μs 3) PC MIX value: 0.9 → 14 4) Number of I/O points: 512 points → 2048 points 5) Number of I/O device points: 512 points → 8192 points 6) Program capacity: 14k steps → 20k steps 7) Number of file register points: 8k points → 64k points (Using memory card: 4086k points) 8) Extension level: 3 → 4 9) Applicable memory: Depending on the memory cassette → Program memory/Standard RAM/Standard ROM/memory card (Sold separately)
	A2ACPU-S1 A2ACPUP21-S1* ¹ A2ACPUR21-S1* ¹ A2ACPUP21-S4* ¹	Q01UCPU	<ol style="list-style-type: none"> 1) I/O control: Refresh only 2) Processing speed (LD instruction): 0.2μs → 0.06μs 3) PC MIX value: 0.9 → 9.79 4) Number of I/O points: 1024 points → 1024 points 5) Number of I/O device points: 1024 points → 8192 points 6) Program capacity: 14k steps → 15k steps 7) Number of file register points: 8k points → 64k points 8) Extension level: 7 → 4 9) Applicable memory: Depending on the memory cassette → Program memory/Standard RAM/Standard ROM
		Q03UDVCPU/ Q03UD(E)CPU	<ol style="list-style-type: none"> 1) I/O control: Refresh only 2) Processing speed (LD instruction): 0.2μs → 0.0019μs (Q03UDVCPU), 0.2μs → 0.0095μs (Q03UD(E)CPU) 3) PC MIX value: 0.9 → 227 (Q03UDVCPU)/28 (Q03UD(E)CPU) 4) Number of I/O points: 1024 points → 4096 points 5) Number of I/O device points: 1024 points → 8192 points 6) Program capacity: 14k steps → 30k steps 7) Number of file register points: 8k points → 96k points (Using an extended SRAM cassette for the Q03UDVCPU: 4192k points and using a memory card for the Q03UD(E)CPU: 4086k points) 8) Extension level: 7 → 7 9) Applicable memory: Depending on the memory cassette → Program memory/Standard RAM/Standard ROM/memory card*² (Sold separately)

A/QnA series models to be discontinued		Q series alternative models	
Product	Model	Model	Remarks (restrictions)
CPU module	A3ACPU A3ACPUP21 ^{*1} A3ACPUR21 ^{*1} A3ACPUP21-S3 ^{*1}	Q02UCPU	<ol style="list-style-type: none"> 1) I/O control: Refresh only 2) Processing speed (LD instruction): 0.15μs → 0.04μs 3) PC MIX value: 0.2 → 14 4) Number of I/O points: 2048 points → 2048 points 5) Number of I/O device points: 2048 points → 8192 points 6) Program capacity: 30k × 2 steps → 20k steps 7) Number of file register points: 8k points → 64k points (Using memory card: 4086k points) 8) Extension level: 7 → 4 9) Applicable memory: Depending on the memory cassette → Program memory/Standard RAM/Standard ROM/memory card (Sold separately)
		Q06UDVCPU/ Q06UD(E)HCPU	<ol style="list-style-type: none"> 1) I/O control: Refresh only 2) Processing speed (LD instruction): 0.15μs → 0.0019μs (Q06UDVCPU), 0.15μs → 0.0095μs (Q06UD(E)HCPU) 3) PC MIX value: 0.2 → 227 (Q06UDVCPU)/60 (Q06UD(E)HCPU) 4) Number of I/O points: 2048 points → 4096 points 5) Number of I/O device points: 2048 points → 8192 points 6) Program capacity: 30k × 2 steps → 60k steps 7) Number of file register points: 8k points → 384k points (Using an extended SRAM cassette for the Q06UDVCPU: 4480k points and using a memory card for the Q06UD(E)HCPU: 4086k points) 8) Extension level: 7 → 7 9) Applicable memory: Depending on the memory cassette → Program memory/Standard RAM/Standard ROM/memory card^{*2} (Sold separately)
	A2UCPU	Q01UCPU	<ol style="list-style-type: none"> 1) I/O control: Refresh only 2) Processing speed (LD instruction): 0.2μs → 0.06μs 3) PC MIX value: 0.9 → 9.79 4) Number of I/O points: 512 points → 1024 points 5) Number of I/O device points: 8192 points → 8192 points 6) Program capacity: 14k steps → 15k steps 7) Number of file register points: 8k points → 64k points 8) Extension level: 3 → 4 9) Applicable memory: Depending on the memory cassette → Program memory/Standard RAM/Standard ROM
		Q02UCPU	<ol style="list-style-type: none"> 1) I/O control: Refresh only 2) Processing speed (LD instruction): 0.2μs → 0.04μs 3) PC MIX value: 0.9 → 14 4) Number of I/O points: 512 points → 2048 points 5) Number of I/O device points: 8192 points → 8192 points 6) Program capacity: 14k steps → 20k steps 7) Number of file register points: 8k points → 64k points (Using memory card: 4086k points) 8) Extension level: 3 → 4 9) Applicable memory: Depending on the memory cassette → Program memory/Standard RAM/Standard ROM/memory card (Sold separately)
	A2UCPU-S1	Q01UCPU	<ol style="list-style-type: none"> 1) I/O control: Refresh only 2) Processing speed (LD instruction): 0.2μs → 0.06μs 3) PC MIX value: 0.9 → 9.79 4) Number of I/O points: 1024 points → 1024 points 5) Number of I/O device points: 8192 points → 8192 points 6) Program capacity: 14k steps → 15k steps 7) Number of file register points: 8k points → 64k points 8) Extension level: 3 → 4 9) Applicable memory: Depending on the memory cassette → Program memory/Standard RAM/Standard ROM
		Q02UCPU	<ol style="list-style-type: none"> 1) I/O control: Refresh only 2) Processing speed (LD instruction): 0.2μs → 0.04μs 3) PC MIX value: 0.9 → 14 4) Number of I/O points: 1024 points → 2048 points 5) Number of I/O device points: 8192 points → 8192 points 6) Program capacity: 14k steps → 20k steps 7) Number of file register points: 8k points → 64k points (Using memory card: 4086k points) 8) Extension level: 3 → 4 9) Applicable memory: Depending on the memory cassette → Built-in RAM/built-in flash ROM/memory card (Sold separately)

A/QnA series models to be discontinued		Q series alternative models	
Product	Model	Model	Remarks (restrictions)
CPU module	A3UCPU	Q03UDVCPU/ Q03UD(E)CPU	<ol style="list-style-type: none"> 1) I/O control: Refresh only 2) Processing speed (LD instruction): 0.2μs → 0.0019μs (Q03UDVCPU), 0.15μs → 0.0095μs (Q03UD(E)CPU) 3) PC MIX value: 1.2 → 227 (Q03UDVCPU)/28 (Q03UD(E)CPU) 4) Number of I/O points: 2048 points → 4096 points 5) Number of I/O device points: 8192 points → 8192 points 6) Program capacity: 30k × 2 steps → 30k steps 7) Number of file register points: 8k points → 96k points (Using an extended SRAM cassette for the Q03UDVCPU: 4192k points and using a memory card for the Q03UD(E)CPU: 4086k points) 8) Extension level: 7 → 7 9) Applicable memory: Depending on the memory cassette → Program memory/Standard RAM/Standard ROM/memory card^{*2} (Sold separately)
		Q06UDVCPU/ Q06UD(E)HCPU	<ol style="list-style-type: none"> 1) I/O control: Refresh only 2) Processing speed (LD instruction): 0.15μs → 0.0019μs (Q06UDVCPU), 0.15μs → 0.0095μs (Q06UD(E)HCPU) 3) PC MIX value: 1.2 → 227 (Q06UDVCPU)/60 (Q06UD(E)HCPU) 4) Number of I/O points: 2048 points → 4096 points 5) Number of I/O device points: 8192 points → 8192 points 6) Program capacity: 30k × 2 steps → 60k steps 7) Number of file register points: 8k points → 384k points (Using an extended SRAM cassette for the Q06UDVCPU: 4480k points and using a memory card for the Q06UD(E)HCPU: 4086k points) 8) Extension level: 7 → 7 9) Applicable memory: Depending on the memory cassette → Program memory/Standard RAM/Standard ROM/memory card^{*2} (Sold separately)
CPU module	A4UCPU	Q06UDVCPU/ Q06UD(E)HCPU	<ol style="list-style-type: none"> 1) I/O control: Refresh only 2) Processing speed (LD instruction): 0.15μs → 0.0019μs (Q06UDVCPU), 0.15μs → 0.0095μs (Q06UD(E)HCPU) 3) PC MIX value: 1.2 → 227 (Q06UDVCPU)/60 (Q06UD(E)HCPU) 4) Number of I/O points: 4096 points → 4096 points 5) Number of I/O device points: 8192 points → 8192 points 6) Program capacity: 30k × 4 steps → 60k steps 7) Number of file register points: 8k points → 384k points (Using an extended SRAM cassette for the Q06UDVCPU: 4480k points and using a memory card for the Q06UD(E)HCPU: 4086k points) 8) Extension level: 7 → 7 9) Applicable memory: Depending on the memory cassette → Program memory/Standard RAM/Standard ROM/memory card^{*2} (Sold separately)
		Q13UDVCPU/ Q13UD(E)HCPU	<ol style="list-style-type: none"> 1) I/O control: Refresh only 2) Processing speed (LD instruction): 0.15μs → 0.0019μs (Q13UDVCPU), 0.15μs → 0.0095μs (Q13UD(E)HCPU) 3) PC MIX value: 1.2 → 227 (Q13UDVCPU)/60 (Q13UD(E)HCPU) 4) Number of I/O points: 4096 points → 4096 points 5) Number of I/O device points: 8192 points → 8192 points 6) Program capacity: 30k × 4 steps → 130k steps 7) Number of file register points: 8k points → 512k points (Using an extended SRAM cassette for the Q13UDVCPU: 4608k points and using a memory card for the Q13UD(E)HCPU: 4086k points) 8) Extension level: 7 → 7 9) Applicable memory: Depending on the memory cassette → Program memory/Standard RAM/Standard ROM/memory card^{*2} (Sold separately)

A/QnA series models to be discontinued		Q series alternative models	
Product	Model	Model	Remarks (restrictions)
CPU module	Q2ACPU	Q02UCPU	<ol style="list-style-type: none"> 1) I/O control: Refresh only 2) Processing speed (LD instruction): 0.2μs → 0.04μs 3) PC MIX value: 1.3 → 14 4) Number of I/O points: 512 points → 2048 points 5) Number of I/O device points: 8192 points → 8192 points 6) Program capacity: 28k steps → 20k steps 7) Number of file register points: 1018k points → 64k points (Using memory card: 4086k points) 8) Extension level: 3 → 4 9) Number of memory cards: 2 → 1 10) Maximum of memory card SRAM capacity: 2M bytes × 2 cards → 8M bytes × 1 card
		Q03UDVCPU/ Q03UD(E)CPU	<ol style="list-style-type: none"> 1) I/O control: Refresh only 2) Processing speed (LD instruction): 0.2μs → 0.0019μs (Q03UDVCPU), 0.2μs → 0.0095μs (Q03UD(E)CPU) 3) PC MIX value: 1.3 → 227 (Q03UDVCPU)/28 (Q03UD(E)CPU) 4) Number of I/O points: 512 points → 4096 points 5) Number of I/O device points: 8192 points → 8192 points 6) Program capacity: 28k steps → 30k steps 7) Number of file register points: 1018k points → 96k points (Using an extended SRAM cassette for the Q03UDVCPU: 4192k points and using a memory card for the Q03UD(E)CPU: 4086k points) 8) Extension level: 3 → 7 9) Number of memory cards: 2 → 1 10) Maximum of memory card SRAM capacity^{*2*3}: 2M bytes × 2 cards → 8M bytes × 1 card
	Q2ACPU-S1	Q03UDVCPU/ Q03UD(E)CPU	<ol style="list-style-type: none"> 1) I/O control: Refresh only 2) Processing speed (LD instruction): 0.2μs → 0.0019μs (Q03UDVCPU), 0.2μs → 0.0095μs (Q03UD(E)CPU) 3) PC MIX value: 1.3 → 227 (Q03UDVCPU)/28 (Q03UD(E)CPU) 4) Number of I/O points: 1024 points → 4096 points 5) Number of I/O device points: 8192 points → 8192 points 6) Program capacity: 60k steps → 30k steps 7) Number of file register points: 1018k points → 96k points (Using an extended SRAM cassette for the Q03UDVCPU: 4192k points and using a memory card for the Q03UD(E)CPU: 4086k points) 8) Extension level: 7 → 7 9) Number of memory cards: 2 → 1 10) Maximum of memory card SRAM capacity^{*2*3}: 2M bytes × 2 cards → 8M bytes × 1 card
		Q06UDVCPU/ Q06UD(E)HCPU	<ol style="list-style-type: none"> 1) I/O control: Refresh only 2) Processing speed (LD instruction): 0.2μs → 0.0019μs (Q06UDVCPU), 0.2μs → 0.0095μs (Q06UD(E)HCPU) 3) PC MIX value: 1.3 → 227 (Q06UDVCPU)/60 (Q06UD(E)HCPU) 4) Number of I/O points: 1024 points → 4096 points 5) Number of I/O device points: 8192 points → 8192 points 6) Program capacity: 60k steps → 60k steps 7) Number of file register points: 1018k points → 384k points (Using an extended SRAM cassette for the Q06UDVCPU: 4480k points and using a memory card for the Q06UD(E)HCPU: 4086k points) 8) Extension level: 7 → 7 9) Number of memory cards: 2 → 1 10) Maximum of memory card SRAM capacity^{*2*3}: 2M bytes × 2 cards → 8M bytes × 1 card

A/QnA series models to be discontinued		Q series alternative models	
Product	Model	Model	Remarks (restrictions)
CPU module	Q3ACPU	Q04UD(E)HCPU/ Q04UDVCPU	<ol style="list-style-type: none"> 1) I/O control: Refresh only 2) Processing speed (LD instruction): 0.15μs \rightarrow 0.0019μs (Q04UDVCPU), 0.15μs \rightarrow 0.0095μs (Q04UD(E)HCPU) 3) PC MIX value: 1.8 \rightarrow 227 (Q04UDVCPU)/60 (Q04UD(E)HCPU) 4) Number of I/O points: 2048 points \rightarrow 4096 points 5) Number of I/O device points: 8192 points \rightarrow 8192 points 6) Program capacity: 92k steps \rightarrow 40k steps 7) Number of file register points: 1018k points \rightarrow 128k points (Using an extended SRAM cassette for the Q04UDVCPU: 4224k points and using a memory card for the Q04UD(E)HCPU: 4086k points) 8) Extension level: 7 \rightarrow 7 9) Number of memory cards: 2 \rightarrow 1 10) Maximum of memory card SRAM capacity^{*2*3}: 2M bytes \times 2 cards \rightarrow 8M bytes \times 1 card
		Q13UD(E)HCPU/ Q13UDVCPU	<ol style="list-style-type: none"> 1) I/O control: Refresh only 2) Processing speed (LD instruction): 0.15μs \rightarrow 0.0019μs (Q13UDVCPU), 0.15μs \rightarrow 0.0095μs (Q13UD(E)HCPU) 3) PC MIX value: 1.8 \rightarrow 227 (Q13UDVCPU)/60 (Q13UD(E)HCPU) 4) Number of I/O points: 2048 points \rightarrow 4096 points 5) Number of I/O device points: 8192 points \rightarrow 8192 points 6) Program capacity: 92k steps \rightarrow 130k steps 7) Number of file register points: 1018k points \rightarrow 512k points (Using an extended SRAM cassette for the Q13UDVCPU: 4608k points and using a memory card for the Q13UD(E)HCPU: 4086k points) 8) Extension level: 7 \rightarrow 7 9) Number of memory cards: 2 \rightarrow 1 10) Maximum of memory card SRAM capacity^{*2*3}: 2M bytes \times 2 cards \rightarrow 8M bytes \times 1 card
	Q4ACPU	Q06UD(E)HCPU/ Q06UDVCPU	<ol style="list-style-type: none"> 1) I/O control: Refresh only 2) Processing speed (LD instruction): 0.075μs \rightarrow 0.0019μs (Q06UDVCPU), 0.075μs \rightarrow 0.0095μs (Q06UD(E)HCPU) 3) PC MIX value: 3.8 \rightarrow 227 (Q06UDVCPU)/60 (Q06UD(E)HCPU) 4) Number of I/O points: 4096 points \rightarrow 4096 points 5) Number of I/O device points: 8192 points \rightarrow 8192 points 6) Program capacity: 124k steps \rightarrow 60k steps 7) Number of file register points: 1018k points \rightarrow 384k points (Using an extended SRAM cassette for the Q06UDVCPU: 4480k points and using a memory card for the Q06UD(E)HCPU: 4086k points) 8) Extension level: 7 \rightarrow 7 9) Number of memory cards: 2 \rightarrow 1 10) Maximum of memory card SRAM capacity^{*2*3}: 2M bytes \times 2 cards \rightarrow 8M bytes \times 1 card
		Q13UD(E)HCPU/ Q13UDVCPU	<ol style="list-style-type: none"> 1) I/O control: Refresh only 2) Processing speed (LD instruction): 0.15μs \rightarrow 0.0019μs (Q13UDVCPU), 0.15μs \rightarrow 0.0095μs (Q13UD(E)HCPU) 3) PC MIX value: 1.8 \rightarrow 227 (Q13UDVCPU)/60 (Q13UD(E)HCPU) 4) Number of I/O points: 2048 points \rightarrow 4096 points 5) Number of I/O device points: 8192 points \rightarrow 8192 points 6) Program capacity: 124k steps \rightarrow 130k steps 7) Number of file register points: 1018k points \rightarrow 512k points (Using an extended SRAM cassette for the Q13UDVCPU: 4608k points and using a memory card for the Q13UD(E)HCPU: 4086k points) 8) Extension level: 7 \rightarrow 7 9) Number of memory cards: 2 \rightarrow 1 10) Maximum of memory card SRAM capacity^{*2*3}: 2M bytes \times 2 cards \rightarrow 8M bytes \times 1 card
	A2CCPU A2CCPUP21*1 A2CCPUR21*1 A2CCPUC24-PRF A2CCPUC24*4 A2CJCPU-S3	Q00UCPU	<ol style="list-style-type: none"> 1) I/O control: Refresh only 2) Processing speed (LD instruction): 1.25μs \rightarrow 0.08μs 3) PC MIX value: 0.1 \rightarrow 7.36 4) Number of I/O points: 512 points \rightarrow 1024 points 5) Number of I/O device points: 512 points \rightarrow 8192 points 6) Program capacity: 8k steps \rightarrow 10k steps 7) Number of file register points: 0k point \rightarrow 64k points 8) Remote I/O: MINI-S3 \rightarrow CC-Link 9) Applicable memory: Built-in RAM /4KROM /8KROM /16ROM \rightarrow Program memory /Standard RAM /Standard ROM/memory card 10) Micro computer program: Available \rightarrow Not available

*1 The CPU module with the MELSECNET link function can be replaced with the CPU module and the link module as listed in the following table.

Model	Alternative models		Precaution
	CPU module model	Network module model	
A1NCPUP21 A2NCPUP21 A2NCPUP21-S1 A3NCPUP21 A2ACPUP21 A2ACPUP21-S1 A3ACPUP21 A2CCPUP21	Select a CPU module depending on the control targets of the A series CPU module.	QJ71LP21-25	Mounting the A/QnA series CPU module with the link function on a base unit → Mounting a link module on a base unit (1 slot is required and 32 points are occupied.)
A1NCPUR21 A2NCPUR21 A2NCPUR21-S1 A3NCPUR21 A2ACPUR21 A2ACPUR21-S1 A3ACPUR21 A2CCPUR21		QJ71BR11	Mounting the A/QnA series CPU module with the link function on a base unit → Mounting a link module on a base unit (1 slot is required and 32 points are occupied.) Coaxial loop → Coaxial bus
A1NCPUP21-S3 A2NCPUP21-S3 A2NCPUP21-S4 A3NCPUP21-S3 A2ACPUP21-S3 A2ACPUP21-S4 A3ACPUP21-S3		QJ71LP21G	Mounting the A/QnA series CPU module with the link function on a base unit → Mounting a link module on a base unit (1 slot is required and 32 points are occupied.)

*2 The High-speed Universal model QCPU (QnUDVCPU) supports an SD memory card.

*3 The High-speed Universal model QCPU (QnUDVCPU) does not support an SRAM memory card.

*4 The CPU module with the communications function can be replaced with the CPU module and the communication module as listed in the following table.

Model	Alternative models		Precaution
	CPU module model	communication module model	
A2CCPUC24 A2CCPUC24-PRF	Select a CPU module depending on the control targets of the A series CPU module.	QJ71C24N	Mounting the A/QnA series CPU module with the communications function on a base unit → Mounting a communication module on a base unit (1 slot is required and 32 points are occupied.)

*5 The existing A2CCPU is the CPU module with the MINI-S3 master function. This module can be replaced with the CPU module and CC-Link master/local module (QJ61BT11N).

2.2 CPU Module Specifications Comparisons

○: Usable △: Partially different in specifications (eg. setting method) ×: Unusable

Function	Description	A/QnA series					
		A2CCPU	AnNCPU	AnACPU	AnUCPU	QnACPU	
Control method	Repetitive operation of stored program	○	○	○	○	○	
I/O control method	Refresh mode/Direct mode	○	○ ^{*1}	○ ^{*2}	○ ^{*2}	○ ^{*2}	
Programming language	Language dedicated to sequence control (Relay symbol, Logic symbol, MELSAP language)	○	○	○	○	○	
Processing speed	Sequence instruction (μs/step)	1.25	1.0	0.15	0.15	0.075	
Watchdog timer (WDT)	Watchdog timer (WDT) (ms)	10 to 2000	10 to 2000	200	200	10 to 2000	
Memory capacity	User memory capacity (bytes)	32k (Built-in RAM)	Max.448k (Memory cassette)	Max.768k (Memory cassette)	Max.1024k (Memory cassette)	Max.2036k × 2 (SRAM card)	
	Sold separately	-	Memory cassette	Memory cassette	Memory cassette	Memory card SRAM: Max.2M	
Program capacity	Sequence program (steps)	Max.8k	Max.30K × 2	Max.30K × 2	Max.30K × 4	Max.124k	
	Microcomputer program (bytes)	Max.14k	Max.58k	×	×	×	
Number of occupied I/O points	Number of I/O points (points) ^{*5}	512	256 to 2048	512 to 2048	512 to 4096	512 to 4096	

*1 Direct I/O is also selectable with the I/O control method setting switch.

*2 Basically, only the refresh mode is applicable, but some instructions/devices can be input/output in the direct mode.

*3 This is the capacity for the maximum number of steps in a sequence program.

*4 Only one memory card can be used.

*5 This is the number of applicable points for the access to the I/O modules actually connected.

*6 The processing speed of the High-speed Universal model QCPU (QnUDVCPUs) is 0.0019ms/step.

*7 The standard ROM capacity of the Q03UDVCPUs, Q04UDVCPUs, and Q06UDVCPUs is 1025.5K bytes.

*8 The standard ROM capacity of the Q13UDVCPUs is 2051K bytes.

*9 The High-speed Universal model QCPU (QnUDVCPUs) supports an SD memory card.

○: Usable △: Partially different in specifications (eg. setting method) ×: Unusable

	Universal model QCPU							Precaution for replacement	Reference
	Q00UCPU	Q01UCPU	Q02UCPU	Q03UDVCPU Q03UD(E)CPU	Q04UDVCPU Q04UD(E)HCPU	Q06UDVCPU Q06UD(E)HCPU	Q13UDVCPU Q13UD(E)HCPU		
	○	○	○	○	○	○	○	-	-
	○ ^{*2}	○ ^{*2}	○ ^{*2}	○ ^{*2}	○ ^{*2}	○ ^{*2}	○ ^{*2}	Use direct I/O instructions to input/output in the direct mode, as the Q series supports the refresh mode only.	Section 7.7.2
	○	○	○	○	○	○	○	The MELSAP language for QnA/Q series is MELSAP3 and that for A series is MELSAP- II.	Section 7.6
	0.08	0.06	0.04	0.02 ^{*6}	0.0095 ^{*6}	0.0095 ^{*6}	0.0095 ^{*6}	-	-
	10 to 2000	10 to 2000	10 to 2000	10 to 2000	10 to 2000	10 to 2000	10 to 2000	-	-
	(Setting available in 10ms unit.)							-	-
	<ul style="list-style-type: none"> • Program memory^{*3}: 40K • Standard RAM: 128K • Standard ROM: 512K 	<ul style="list-style-type: none"> • Program memory^{*3}: 60K • Standard RAM: 128K • Standard ROM: 512K 	<ul style="list-style-type: none"> • Program memory^{*3}: 80K • Standard RAM: 64K • Standard ROM: 512K 	<ul style="list-style-type: none"> • Program memory^{*3}: 120K • Standard RAM: 192K • Standard ROM^{*7}: 1024K 	<ul style="list-style-type: none"> • Program memory^{*3}: 160K • Standard RAM: 256K • Standard ROM^{*7}: 1024K 	<ul style="list-style-type: none"> • Program memory^{*3}: 240K • Standard RAM: 768K • Standard ROM^{*7}: 1024K 	<ul style="list-style-type: none"> • Program memory^{*3}: 520K • Standard RAM: 1024K • Standard ROM^{*8}: 2048K 	A memory cassette is required for the A series as user memory, while the user memory is included in the Q series as standard equipment	Section 2.4.1
	×	×	Memory card ^{*4} RAM: Max.8M Flash: Max.4M ATA: Max.32M SD ^{*9} : 2G/4G	Memory card ^{*4} RAM: Max.8M Flash: Max.4M ATA: Max.32M SD ^{*9} : 2G/4G	Memory card ^{*4} RAM: Max.8M Flash: Max.4M ATA: Max.32M SD ^{*9} : 2G/4G	Memory card ^{*4} RAM: Max.8M Flash: Max.4M ATA: Max.32M SD ^{*9} : 2G/4G	Memory card ^{*4} RAM: Max.8M Flash: Max.4M ATA: Max.32M SD ^{*9} : 2G/4G	-	-
	Max.10K	Max.15K	Max.20K	Max.30K	Max.40K	Max.60K	130K130K	-	-
	×	×	×	×	×	×	×	The Q series does not include microcomputer program. Therefore, consider use of sequence program, etc as the substitution.	-
	1024	1024	2048	4096	4096	4096	4096	-	-

○: Usable △: Partially different in specifications (eg. setting method) ×: Unusable

Function	Description	A/QnA series						
		A2CCPU	AnNCPU	AnACPU	AnUCPU	QnACPU		
Number of device points	Input device (X) ^{*10}	512	256 to 2048	512 to 2048	8192	8192		
	Output device (Y) ^{*10}	512	256 to 2048	512 to 2048	8192	8192		
	Internal relay (M)	Total 2048	Total 2048	Total 8192	Total 8192	8192		
	Latch relay (L)					8192		
	Step relay (S)					8192 ^{*11}		
	Annunciator (F)	256	256	2048	2048	2048		
	Edge relay (V)	×	×	×	×	2048		
	Link relay (B)	1024	1024	4096	8192	8192		
	Timer (T)	256	256	2048	2048	2048		
	Counter (C)	256	256	1024	1024	1024		
	Data register (D)	1024	1024	6144	8192	12288		
	Link register (W)	1024	1024	4096	8192	8192		
	File register (R)	R	4096	8192	8192	8192	32768	
		ZR	×	×	×	×	Max.1018k	
	Accumulator (A)	2	2	2	2	×		
	Index register	(Z)	1	1	7	7	16	
		(V)	1	1	7	7	×	
	Nesting (N)	8	8	8	8	15		
	Pointer (P)	256	256	256	256	4096		
	Interrupt pointer (I)	×	32	32	32	48		
	Special relay (M/SM)	256	256	256	256	2048		
	Special register (D/SD)	256	256	256	256	2048		
	Link special relay (SB)	×	×	×	×	2048		
	Link special register (SW)	×	×	×	×	2048		
	Function input (FX)	×	×	×	×	16		
	Function output (FY)	×	×	×	×	16		
	Function register (FD)	×	×	×	×	5		
Number of comment points	Comment points ^{*12}	Max.1600	Max.4032	Max.4032	Max.4032	Max. approx.50k		
	Extended comment	Max.3968	Max.3968	Max.3968	Max.3968	×		
Self-diagnostics	Watchdog timer (WDT), Memory error detection, CPU error detection, Battery error detection	○	○	○	○	○		
Operation mode at error occurrence	Stop/Continue setting	○	○	○	○	○		
Output mode switching at changing from STOP to RUN	Re-output operation status before STOP/Selection of output after operation execution	○	○	○	○	○		

*10 This number means the number of useable points on the program.

*11 Step relay (S) of the QnAS series and Q series is the SFC dedicated relay.

*12 This is the number of points that can be written to CPU module.

*13 The High-speed Universal model QCPU (QnUDVCPU) supports an SD memory card.

*14 The data can be stored in only standard RAM of the High-speed Universal model QCPU (QnUDVCPU).

○: Usable △: Partially different in specifications (eg. setting method) ×: Unusable

	Universal model QCPU							Precaution for replacement	Reference
	Q00UCPU	Q01UCPU	Q02UCPU	Q03UDVCPU Q03UD(E)CPU	Q04UDVCPU Q04UD(E)HCPU	Q06UDVCPU Q06UD(E)HCPU	Q13UDVCPU Q13UD(E)HCPU		
	8192	8192	8192	8192	8192	8192	8192	-	
	8192	8192	8192	8192	8192	8192	8192	-	
	8192	8192	8192	9216 (Q03UDVCPU) 8192 (Q03UD(E)CPU)	15360 (Q04UDVCPU) 8192 (Q04UD(E)HCPU)	15360 (Q06UDVCPU) 8192 (Q06UD(E)HCPU)	28672 (Q13UDVCPU) 8192 (Q13UD(E)HCPU)	-	
	8192	8192	8192	8192	8192	8192	8192	-	
	8192 ^{*11}	8192 ^{*11}	8192 ^{*11}	8192 ^{*11}	8192 ^{*11}	8192 ^{*11}	8192 ^{*11}	-	
	2048	2048	2048	2048	2048	2048	2048	-	
	2048	2048	2048	2048	2048	2048	2048	-	
	8192	8192	8192	8192	8192	8192	8192	-	
	2048	2048	2048	2048	2048	2048	2048	-	
	1024	1024	1024	1024	1024	1024	1024	-	
	12288	12288	12288	13312 (Q03UDVCPU) 12288 (Q03UD(E)CPU)	22528 (Q04UDVCPU) 12288 (Q04UD(E)HCPU)	22528 (Q06UDVCPU) 12288 (Q06UD(E)HCPU)	41984 (Q13UDVCPU) 12288 (Q13UD(E)HCPU)	-	
	8192	8192	8192	8192	8192	8192	8192	-	
	32768	32768	32768	32768	32768	32768	32768	-	
	65536	65536	65536 (when a memory card is used: + Max.4086K)	98304 (when a memory card ^{*13} is used: + Max.4086K)	131072 (when a memory card ^{*13} is used: + Max.4086K)	22528 (Q06UDVCPU) 12288 (Q06UD(E)HCPU)	41984 (Q13UDVCPU) 12288 (Q13UD(E)HCPU)	-	
	×	×	×	×	×	×	×	Accumulators are converted to the special registers (SD718, SD719) upon A → Q program conversion as they are not included in the Q series.	Section 7.7.8
	20	20	20	20	20	20	20	-	
	×	×	×	×	×	×	×	This is used as edge relay for the Q series.	
	15	15	15	15	15	15	15	-	
	512	512	4096	4096	4096	4096	4096	-	
	128	128	256	256	256	256	256	-	
	2048	2048	2048	2048	2048	2048	2048	-	
	2048	2048	2048	2048	2048	2048	2048	-	
	2048	2048	2048	2048	2048	2048	2048	-	
	2048	2048	2048	2048	2048	2048	2048	-	
	16	16	16	16	16	16	16	-	
	16	16	16	16	16	16	16	-	
	5	5	5	5	5	5	5	-	
	Within the total memory capacity of Program memory + Standard RAM ^{*14} + Standard ROM							-	
	×	×	×	×	×	×	×	-	
	○	○	○	○	○	○	○	-	
	○	○	○	○	○	○	○	-	
	○	○	○	○	○	○	○	-	

2.3 CPU Module Functional Comparisons

2.3.1 Functional comparisons between A2CCPU, AnNCPU and Q series CPU modules

○: Usable △: Partially different in specifications (eg. setting method) ×: Unusable

Function	Description	A series		Q series	Precaution for replacement	Reference
		A2CCPU	AnNCPU	QnUCPU		
Control	Constant scan	○	○	△	Set this function with the special register (D9020) for A series, and with parameters for Q series.	-
	Latch (power backup)	○	○	○	-	-
	Remote RUN/STOP	○	○	○	-	-
	PAUSE	○	○	△	Set the PAUSE enable flag with the special relay (M9040) for A series, and with the special relay (SM206) for Q series.*1	Section 7.4.1
	Interrupt processing	○	○	△	For A series, an interrupt program is required for each main program and sub-program separately. For Q series, create only one interrupt program to share between the two programs.	Section 7.7.10
	Microcomputer mode	○	○	×	Consider use of sequence program, etc., as the substitution. The Q series does not include the instructions by a utility package. Therefore, modify the corresponding instructions of QCPU and substitute them.	-
	Display priority of ERROR LED	○	×	○	Target errors vary by model, but there is no functional difference	-
	ROM operation	○	○	△	With the Universal model QCPU, the ROM operation is not required since the program memory is the flash ROM.	Section 7.7.12

*1 Device numbers are converted upon the programmable controller type change by GX Developer. (Refer to Section 7.4.)

○: Usable △: Partially different in specifications (eg. setting method) ×: Unusable

Function	Description	A series		Q series	Precaution for replacement	Reference
		A2CCPU	AnNCPU	QnUCPU		
Control	Data protection function (System protect, Keyword registration/ Password registration)	○	○	△	The Q series prohibits each file from being read/written by password registration, whereas the A series prohibits the parameters and programs from being read/written to the user memory by keyword registration.	Section 2.4.2
	The settings of output status at changing from STOP to RUN	○	○	○	In case of transition from the A series, it is necessary to re-set the parameters.	-
	Clock function	A CPU includes a clock, of which data can be read and written. The clock data consists of year, month, date, hour, minute, second and a day of the week.	○*1	○	△	The Q series handles the four digits of the year (western calendar), whereas the A series handles only the last two digits.
Debug	Write during RUN	○	○	○	For the Q series, it is necessary to set the reserved capacity for the write during RUN in advance (default-set to 500 steps).	Section 2.4.3
	Status latch	○	○*2	×	The Q series does not include the status latch function.	-
	Sampling trace	○	○*2	○*3	-	-
	Step operation	×	○	×	The Q series does not include the step operation function. Consider debugging with the simulation function of GX Works2.	-
	Off-line switch	○	○	×	The Q series does not include the off-line switch function. Consider using the forced on/off function for external I/O.	-
Maintenance	Online I/O module replacement	×	○	×	Replace I/O module while CPU is in RUN (only supported for Process CPU).	-
	Self-diagnostics function	○	○	○	Error codes differ between the A series and Q series.	-

*1 Only A2CCPUC24 (-PRF) is applicable. A2CJCPU-S3 and A2CCPU (P21/R21) are not.

*2 The A1NCPU (P21/R21) is not applicable.

*3 The Q00UJCPU does not support the sampling trace function.

2.3.2 Functional comparisons between AnACPU, AnUCPU and Q series CPU modules

○: Usable △: Partially different in specifications (eg. setting method) ×: Unusable

Function	Description	A series		Q series	Precaution for replacement	Reference
		AnACPU	AnUCPU	QnUCPU		
Control	Constant scan	○	○	△	Set this function with the special register (D9020) for A series, and with parameters for Q series.	-
	Latch (power backup)	○	○	○	-	-
	Remote RUN/STOP	○	○	○	-	-
	PAUSE	○	○	△	Set the PAUSE enable flag with the special relay (M9040) for A series, and with the special relay (SM206) for Q series.*1	Section 7.4.1
	Interrupt processing	○	○	△	For A series, an interrupt program is required for each main program and sub-program separately. For Q series, create only one interrupt program to share between the two programs.	Section 7.7.10
	Display priority of ERROR LED	○	○	○	Target errors vary by model, but there is no functional difference.	-
	ROM operation	○	○	△	With the Universal model QCPU, the ROM operation is not required since the program memory is the flash ROM.	Section 7.7.12
	Data protection function (System protect, Keyword registration/ Password registration)	○	○	△	The Q series prohibits each file from being read/written by password registration, whereas the A series prohibits the parameters and programs from being read/ written to the user memory by keyword registration.	Section 2.4.2

*1 Device numbers are converted upon the programmable controller type change by GX Developer. (Refer to Section 7.4.)

○: Usable △: Partially different in specifications (eg. setting method) ×: Unusable

Function	Description	A series		Q series	Precaution for replacement	Reference
		AnACPU	AnUCPU	QnUCPU		
Control	The settings of output status at changing from STOP to RUN	○	○	○	In case of transition from the A series, it is necessary to re-set the parameters.	-
	Clock function	○	○	△	The Q series handles the four digits of the year (western calendar), whereas the A series handles only the last two digits.	-
Debug	Write during RUN	○	○	○	For the Q series, it is necessary to set the reserved capacity for the write during RUN in advance (default-set to 500 steps).	Section 2.4.3
	Status latch	○	○	×	The Q series does not include the status latch function.	-
	Sampling trace	○	○	○ ^{*1}	-	-
	Step operation	○	○	×	The Q series does not include the step operation function. Consider debugging with the simulation function of GX Works2.	-
Maintenance	Online I/O module replacement	○	○	×	Replace I/O module while CPU is in RUN. (Only supported for Process CPU)	-
	Self-diagnostics function	○	○	○	Error codes differ between the A series and Q series.	-
	Error history	○	○	○	The Q series can store error history data in a memory card (up to 100 errors) as well as in the built-in memory.	-

*1 The Q00JCPU does not support the sampling trace function.

2.3.3 Functional comparison between QnACPU and Q series CPU

○: Usable △: Partially different in specifications (eg. setting method) ×: Unusable

Function	Contents	QnA series	Q series	Precaution for replacement	Reference	
		QnACPU	QnUCPU			
Control	Constant scan	Executes the sequence program at the constant time intervals regardless of the processing time of the program.	○	○	-	-
	Latch (power backup)	Holds the data of devices in the event of power OFF, resetting, and a momentary power failure longer than the allowable momentary power failure period.	○	○	-	-
	Remote RUN/STOP	Executes the remote RUN/STOP using external switches and peripheral devices.	○	○	-	-
	PAUSE	Stops operations while holding the output status.	○	○	-	-
	Interrupt processing	Executes the program that corresponds to the cause when an interrupt cause occurs.	○	○	-	-
	Display priority of ERROR LED	The settings for ON/OFF of ERROR LED at the occurrence of error.	○	○	Target errors vary by model, but there is no functional difference.	-
	File management	Manages all of parameters, sequence programs, device comments, file registers, etc as files.	○	○	Memory configuration and data to be stored differ between the QnA series and Q series.	Section 2.4.1
	Structured program	Selects a suitable execution type for program application, and divides each program by designer, process or others.	○	○	-	-
	I/O assignment	Performs the I/O assignment to any individual module regardless of its mounted position.	○	△	When using a base unit with other than 8 slots, set the number of slots with the parameter (I/O assignment setting).	Section 2.4.4
	Boot run (ROM operation)	Executes the sequence program after reading it from the memory card to the CPU built-in memory when the CPU goes to RUN mode.	○	△	With the Universal model QCPU, the ROM operation is not required since the program memory is the flash ROM.	Section 2.4.1
	Data protection (System protected, Keyword registration/ Password registration)	Prohibits peripheral devices to read/write the programs and comments in the CPU built-in memory, memory cassette, or memory card.	○	△	The Q series provides read/write protection for each file with password registration. The QnA series prohibits parameters/programs read/write from/to the user memory with keyword registration.	Section 2.4.2
Initial device value	Sets an initial value of device memory, file registers, and special function modules, etc. when the CPU has become RUN status.	○	○	Memory configuration and data to be stored differ between the QnA series and Q series.	Section 2.4.1	

○: Usable △: Partially different in specifications (eg. setting method) ×: Unusable

	Function	Contents	QnA series	Q series	Precaution for replacement	Reference section
			QnACPU	QnUCPU		
Control	Output status setting at changing from STOP to RUN	Sets the output (Y) status at the change from STOP to RUN to re-outputting data before STOP or outputting data after the operation execution.	○	○	Resetting parameters is required to replace the QnA series with the Q series.	-
	Number of general data processing	Sets the number of general data processing executed in one END operation.	○	△	For the Q series use COM instructions or set the communication reserved time with special register (SD315) if necessary.	-
	Clock function	A CPU incorporates a clock, which can be read/written. The clock data consists of year, month, day, hour, minute, second and a day of the week.	○	△	The Q series uses 4-digit year of the western calendar while the QnA series uses the lower 2-digit year.	-
Debug	Write during RUN	Changes (writes to) the program of a CPU in the RUN mode.	○	○	For the Q series, it is necessary to set the reserved capacity for the write during RUN in advance (default-set to 500 steps).	Section 2.4.3
	Status latch	Stores the data of all devices in the memory cassette or memory card at the occurrence of an error for monitoring by the peripheral device.	○*2	×	The Q series does not include the status latch function.	-
	Sampling trace	Stores the data of specified devices at the specified intervals for monitoring by the peripheral device.	○	○*1	-	-
	Program trace	Collects the execution status of specified programs and steps, and stores them in a file.	○*2	×	The Q series does not incorporate the program trace function.	-
	Simulation function	Detaches I/O modules or special modules from the CPU module and test-operations the program upon the step operation.	○*2	×	The Q series does not have the simulation function. Consider debugging with the simulation function of GX Works2.	-
	Step operation	Stops the execution of a sequence program at the specified step.	○	×	The Q series does not include the step operation function. Consider debugging with the simulation function of GX Works2.	-
	Execution time measurement (Program list monitor, scan time measurement)	Measures the operation time for each program.	○	○	-	-
	Module access interval reading	Monitors the access interval of special function modules or peripheral devices.	○	○	For the Q series, access interval is called as "module service interval".	-
Maintenance	Online I/O module replacement	Enables I/O modules to be replaced while the CPU is in RUN.	○	×	Replace I/O module while CPU is in RUN. (Only supported for Process CPU)	-
	Self-diagnostics	Diagnoses whether any error has occurred, detects errors and stop a CPU, etc.	○	○	Error codes differ between the A series and Q series.	-
	Error history	Stores errors, which are detected with the diagnostics function, in a CPU or memory card. The stored history can be monitored with peripheral devices.	○	○	-	-

*1 The Q00UJCPU does not support the sampling trace function.

*2 SW□ IVD/NX-GPPQ is required. This is not applicable to GX Developer.

2.4 Precautions for CPU Module Replacement

2.4.1 Memory for CPU module

The memory configuration is shown in (1). Examine the following points depending on the memory capacity before replacement and applications.

- Memory to store
- To use or not use a memory card

(1) Memory configuration and data that can be stored

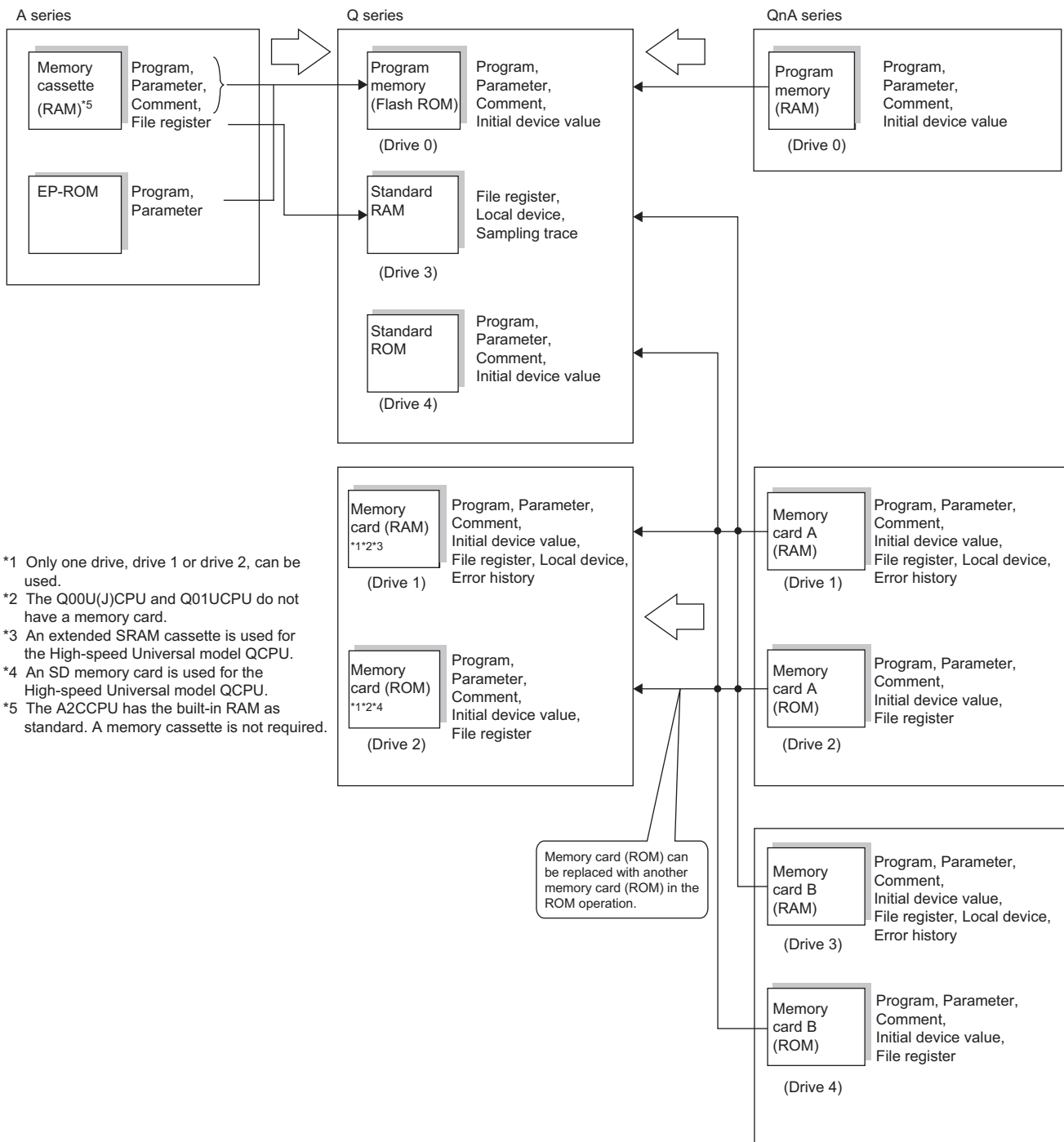

*1 Only one drive, drive 1 or drive 2, can be used.
 *2 The Q00U(J)CPU and Q01UCPU do not have a memory card.
 *3 An extended SRAM cassette is used for the High-speed Universal model QCPU.
 *4 An SD memory card is used for the High-speed Universal model QCPU.
 *5 The A2CCPU has the built-in RAM as standard. A memory cassette is not required.

(2) Capacity of each memory

The following table shows the memory of CPU modules, in which the user program, etc. is stored, together with its capacity.

Item	Model			
	A series	QnA series	Q series	
			High-speed Universal model QCPU (QnUDVCPU)	Universal model QCPU (except QnUDVCPU)
Memory cassette	Max. 1024k bytes	-	8M bytes (extended SRAM cassette)	-
Built-in RAM	Max. 32k bytes (for A2CCPU only)	Max. 496k bytes (Program memory)	Max. 1040k bytes (Program memory)	Max. 4000k bytes (Program memory)
Memory card*1	SRAM card	-	Max. 2M bytes	-
	EEPROM card	-	Max. 512k bytes	-
	Flash card	-	Max. 1M bytes	-
	ATA card	-	-	-
	SD memory card	-	-	Max. 4G bytes
Standard RAM	-	-	Max. 1280k bytes	Max. 1792k bytes (Q00UJCPU: None)
Standard ROM	-	-	Max. 4102k bytes	Max. 16384k bytes

*1 Two memory cards can be installed in total for QnA series and either one of the memory cards can be installed for Q series.

2.4.2 Keyword registration and password registration

The Q series prohibits reading from/writing to programs, etc. when a password is registered, as does the A/QnA series with keyword registration. Available functions are described below.

Item	Model		
	A series	QnA series	Q series
Prohibiting method for writing to program, etc.	The following attribute can be set to the specified memory. • Prohibition of read/write	Either of the following attributes can be set to the specified memory (drive). • Prohibition of read/write display • Prohibition of write	Batch password setting for all files provides the equivalent function. (Supplement) By using a password, the following attributes can be set to each specified file of the specified memory (drive). • Prohibition of read/write display • Prohibition of write

2.4.3 Write during RUN

To execute the write during RUN, it is necessary to, reserve the program capacity for increase upon the write during RUN in advance.

(1) A series

The program capacity is decided by the parameter (memory capacity setting), and can be increased within the capacity range upon write during RUN.

(2) QnA/Q series

It is necessary to set the program capacity for increase upon the write during RUN at Write to PLC. (This set capacity is called as the write during RUN reserved step. By default, 500 steps are reserved.)

The following shows the setting screen for Allocate memory for Write during RUN as a reference.

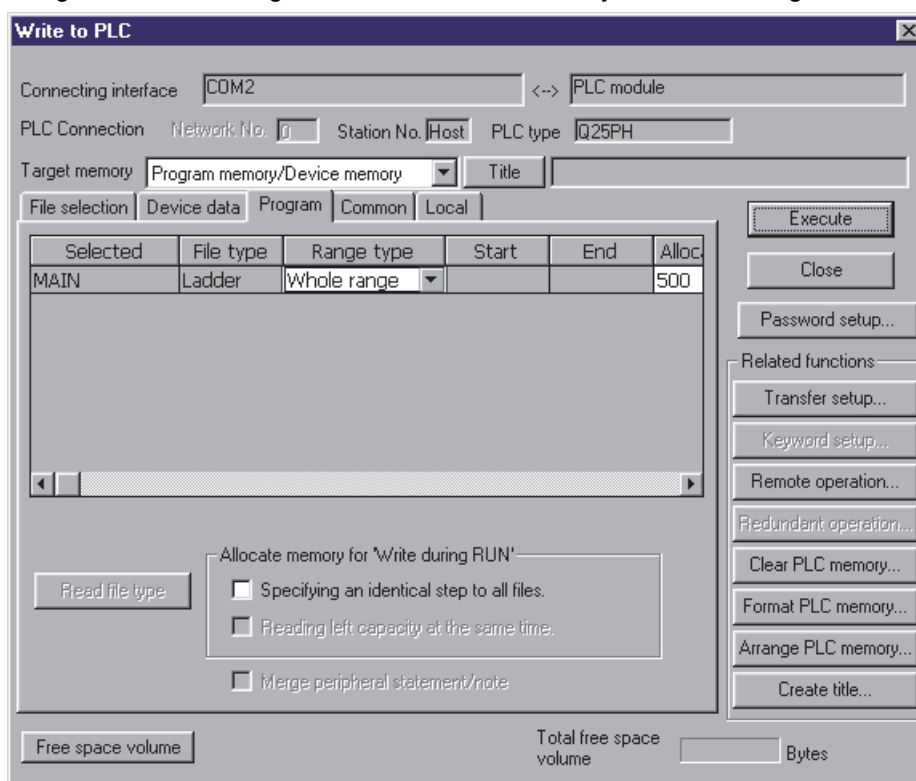

2.4.4 No. of base unit I/O slots

The following table indicates how the No. of base unit I/O slots is allocated for each series.

Item	Model		
	A series	QnA series	Q series
No. of base unit I/O slots	Fixed to 8 slots regardless of the actual number.		To use a base unit other than 8 slots, set the number of slots. (Supplement) Default follows the actual slot number. (Setting changeable with parameter)

The following gives an example of replacing the A35B+A68B system (Default parameter is used) with the Q35B+Q68B system.

(A series I/O assignment before replacement)

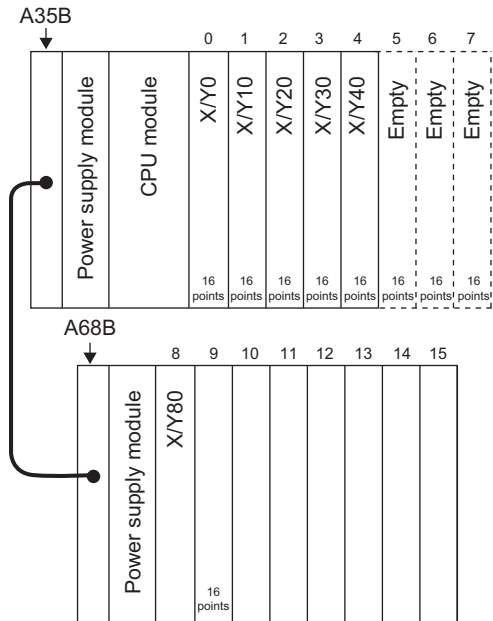

(1) When the start XY address of each slot is set

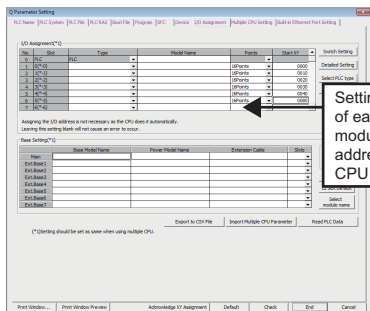

(I/O assignment for the Q series when the start XY address of each slot is set after replacement)

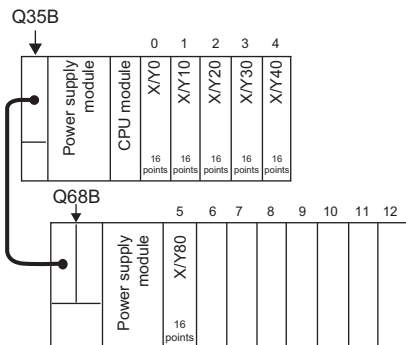

(Q series I/O assignment after replacing modules)

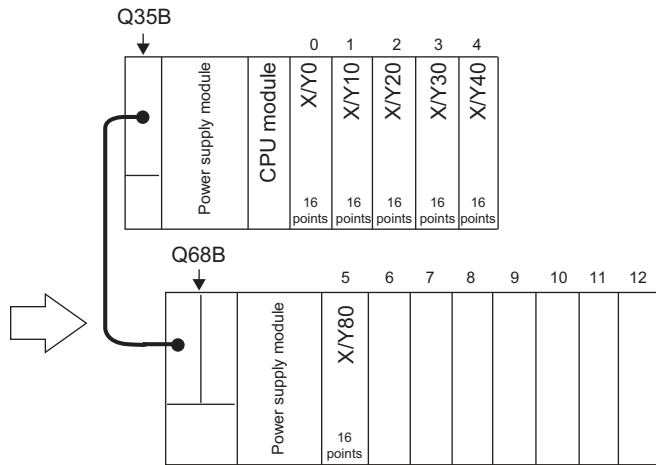

When modules are replaced, the start I/O number of the first extension level becomes [X/Y50].

(2) When the number of slots is "8"

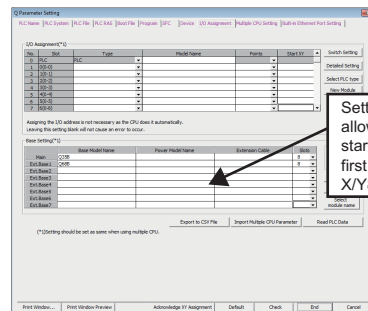

(I/O assignment for the Q series when the number of slots of the base unit is set after replacement)

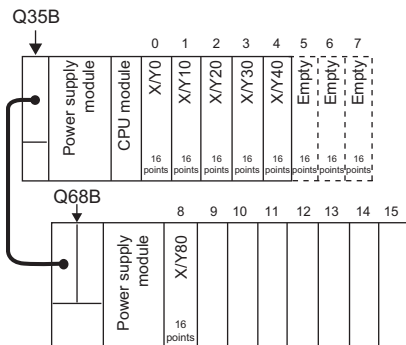

2.4.5 Programming tool and connection cable for Q series CPU

(1) Programming tool for Q series CPU

The programming for the Q series CPU is performed with GX Works2 or GX Developer. Note that the following programming software packages are not applicable.

Compatible CPU	Software package model
ACPU	SW□SRXV-GPPA
	SW□IVD-GPPA
QnACPU	SW□IVD-GPPQ

Remarks

The existing programs for the A/QnA series CPU module cannot be used in GX Works2, because GX Works2 does not support the A/QnA series. Change "PLC type" again after changing the existing program into QCPU by "Change PLC type" on GX Developer and opening the program for the Q series on GX Works2.

(2) Connection cable for Q series CPU

When connecting a personal computer in which GX Works2 or GX Developer has been installed to the Q series CPU, RS-232 connection, USB connection, and Ethernet connection are available.

The availability depending on CPU model is shown in the following table.

Note that the RS-232/RS-422 conversion cable for the A/QnA series CPU are not applicable.

When the RS-232 connection or USB connection is used, an electric shock or a module failure may occur depending on a personal computer model and use conditions. For details, refer to the technical bulletin (No.T99-0032).

CPU model	RS-232 connection	USB connection	Ethernet connection
00UJCPU/Q00UCPU Q01UCPU/Q02UCPU Q03UDCPU/Q04UDHCPU Q06UDHCPU/Q10UDHCPU Q13UDHCPU	Available*1	Available*2 (USB A type - USB miniB type)	Unavailable
Q03UDECPU/Q03UDVCPU Q04UDEHCPU/Q04UDVCPU Q06UDEHCPU/Q06UDVCPU Q10UDEHCPU/ Q13UDEHCPU/Q13UDVCPU	Unavailable		Available

*1 Applicable cable is the QC30R2.

*2 The following cables are used to check the operation.

KU-AMB530 (manufactured by SANWA SUPPLY INC.)

USB-M53 (manufactured by ELECOM CO., LTD)

MR-J3USBCBL3M (manufactured by Mitsubishi Electric Corporation)

GT09-C30USB-5P (manufactured by Mitsubishi Electric System & Service Co., Ltd.)

3 REPLACING I/O MODULES

3.1 List of Alternative I/O Module Models

3.1.1 List of alternative Q series standard type module models

A/QnA series models to be discontinued		Q series alternative models	
Product	Model	Model	Remarks (restrictions)
Input module	AX10	QX10	1) Change in external wiring: Required 2) Change in the number of slots: Not required 3) Change in a program Change in the number of occupied I/O points: Not required 4) Change in specifications Change in rated input voltage: Not required Change in rated input current: Required (Approx. 10mA → Approx. 8mA) Change in ON voltage/ON current: Required Change in OFF voltage/OFF current: Required Change in input resistance: Required 5) Change in functions : Not required
	AX10-UL		1) Change in external wiring: Required 2) Change in the number of slots: Not required 3) Change in a program Change in the number of occupied I/O points: Not required 4) Change in specifications Change in rated input voltage: Not required Change in rated input current: Required (Approx. 11mA → Approx. 8mA) Change in ON voltage/ON current: Required Change in OFF voltage/OFF current: Required Change in input resistance: Required 5) Change in functions : Not required
	AX11	QX10*1	1) Change in external wiring: Required 2) Change in the number of slots: Required (2 modules required) 3) Change in a program Change in the number of occupied I/O points: Not required (32=16 × 2) 4) Change in specifications Change in rated input voltage: Not required Change in rated input current: Required (Approx. 10mA → Approx. 8mA) Change in ON voltage/ON current: Required Change in OFF voltage/OFF current: Required Change in input resistance: Required 5) Change in functions : Not required

A/QnA series models to be discontinued		Q series alternative models	
Product	Model	Model	Remarks (restrictions)
Input module	AX11EU	QX10	1) Change in external wiring: Required 2) Change in the number of slots: Required (2 modules required) 3) Change in a program Change in the number of occupied I/O points: Not required (32=16 × 2) 4) Change in specifications Change in rated input voltage: Not required Change in rated input current: Required (Approx. 12mA → Approx. 8mA) Change in ON voltage/ON current: Required Change in OFF voltage/OFF current: Required Change in input resistance: Required 5) Change in functions : Not required
	AX20	QX28	1) Change in external wiring: Required (Connector terminal block must be converted.) 2) Change in the number of slots: Required (2 modules required) 3) Change in a program Change in the number of occupied I/O points: Required (16 points → 32 points (16 points × 2 modules)) Change in the number of input points: 16 points × 1 module → 8 points × 2 modules 4) Change in specifications Change in rated input voltage: Not required Change in rated input current: Required (Approx. 10mA → Approx. 17mA) Change in ON voltage/ON current: Required Change in OFF voltage/OFF current: Required Change in input resistance: Required 5) Change in functions : Not required
	AX20-UL		1) Change in external wiring: Required (Connector terminal block must be converted.) 2) Change in the number of slots: Required (2 modules required) 3) Change in a program Change in the number of occupied I/O points: Required (16 points → 32 points (16 points × 2 modules)) Change in the number of input points: 16 points × 1 module → 8 points × 2 modules 4) Change in specifications Change in rated input voltage: Not required Change in rated input current: Required (Approx. 11mA → Approx. 17mA) Change in ON voltage/ON current: Required Change in OFF voltage/OFF current: Required Change in input resistance: Required 5) Change in functions : Not required
	AX21	QX28 ^{*1}	1) Change in external wiring: Required 2) Change in the number of slots: Required (4 modules required) 3) Change in a program Change in the number of occupied I/O points: Required (32 points → 64 points (16 points × 4 modules)) Change in the number of input points: 32 points × 1 module → 8 points × 4 modules 4) Change in specifications Change in rated input voltage: Not required Change in rated input current: Required (Approx. 10mA → Approx. 17mA) Change in ON voltage/ON current: Required Change in OFF voltage/OFF current: Required Change in input resistance: Required 5) Change in functions : Not required

A/QnA series models to be discontinued		Q series alternative models	
Product	Model	Model	Remarks (restrictions)
Input module	AX21EU	QX28	1) Change in external wiring: Required 2) Change in the number of slots: Required (4 modules required) 3) Change in a program Change in the number of occupied I/O points: Required (32 points → 64 points (16 points × 4 modules)) Change in the number of input points: 32 points × 1 module → 8 points × 4 modules 4) Change in specifications Change in rated input voltage: Not required Change in rated input current: Required (Approx. 12mA → Approx. 17mA) Change in ON voltage/ON current: Required Change in OFF voltage/OFF current: Required Change in input resistance: Required 5) Change in functions : Not required
	AX31 (when using 24VDC and positive common)	QX41	1) Change in external wiring: Required (Connector terminal block must be converted.) 2) Change in the number of slots: Not required 3) Change in a program Change in the number of occupied I/O points: Not required 4) Change in specifications Change in rated input voltage: Not required Change in rated input current: Required (Approx. 8.5mA → Approx. 4mA) Change in ON voltage/ON current: Required Change in OFF voltage/OFF current: Required Change in input resistance: Required 5) Change in functions : Not required
		QX41-S2	1) Change in external wiring: Required (Connector terminal block must be converted.) 2) Change in the number of slots: Not required 3) Change in a program Change in the number of occupied I/O points: Not required 4) Change in specifications Change in rated input voltage: Not required Change in rated input current: Required (Approx. 8.5mA → Approx. 6mA) Change in ON voltage/ON current: Required Change in OFF voltage/OFF current: Required Change in input resistance: Required 5) Change in functions : Not required
	AX31 (when using 24VDC and negative common)	QX81	1) Change in external wiring: Required (Connector terminal block must be converted.) 2) Change in the number of slots: Not required 3) Change in a program Change in the number of occupied I/O points: Not required 4) Change in specifications Change in rated input voltage: Not required Change in rated input current: Required (Approx. 8.5mA → Approx. 4mA) Change in ON voltage/ON current: Required Change in OFF voltage/OFF current: Required Change in input resistance: Required 5) Change in functions : Not required
		QX81-S2	1) Change in external wiring: Required (Connector terminal block must be converted.) 2) Change in the number of slots: Not required 3) Change in a program Change in the number of occupied I/O points: Not required 4) Change in specifications Change in rated input voltage: Not required Change in rated input current: Required (Approx. 8.5mA → Approx. 6mA) Change in ON voltage/ON current: Required Change in OFF voltage/OFF current: Required Change in input resistance: Required 5) Change in functions : Not required

A/QnA series models to be discontinued		Q series alternative models	
Product	Model	Model	Remarks (restrictions)
Input module	AX31 (when using 12VDC)	QX71	1) Change in external wiring: Required 2) Change in the number of slots: Not required 3) Change in a program Change in the number of occupied I/O points: Not required 4) Change in specifications Change in rated input voltage: Not required Change in rated input current: Required (Approx. 4mA → Approx. 3.3mA) Change in ON voltage/ON current: Required Change in OFF voltage/OFF current: Required Change in input resistance: Required 5) Change in functions : Not required
	AX31 (when using 12/24VDC)	None	Commute and smooth the 12/24VAC externally before inputting to the QX41/QX81 (when using 24VAC) or QX71 (when using 12VAC).
	AX31-S1 (when using positive common)	QX41	1) Change in external wiring: Required (Connector terminal block must be converted.) 2) Change in the number of slots: Not required 3) Change in a program Change in the number of occupied I/O points: Not required 4) Change in specifications Change in rated input voltage: Not required Change in rated input current: Required (Approx. 8.5mA → Approx. 4mA) Change in ON voltage/ON current: Required Change in OFF voltage/OFF current: Required Change in input resistance: Required 5) Change in functions : Not required
		QX41-S2	1) Change in external wiring: Required (Connector terminal block must be converted.) 2) Change in the number of slots: Not required 3) Change in a program Change in the number of occupied I/O points: Not required 4) Change in specifications Change in rated input voltage: Not required Change in rated input current: Required (Approx. 8.5mA → Approx. 6mA) Change in ON voltage/ON current: Required Change in OFF voltage/OFF current: Required Change in input resistance: Required 5) Change in functions : Not required
	AX31-S1 (when using negative common)	QX81	1) Change in external wiring: Required (Connector terminal block must be converted.) 2) Change in the number of slots: Not required 3) Change in a program Change in the number of occupied I/O points: Not required 4) Change in specifications Change in rated input voltage: Not required Change in rated input current: Required (Approx. 8.5mA → Approx. 4mA) Change in ON voltage/ON current: Required Change in OFF voltage/OFF current: Required Change in input resistance: Required 5) Change in functions : Not required
		QX81-S2	1) Change in external wiring: Required (Connector terminal block must be converted.) 2) Change in the number of slots: Not required 3) Change in a program Change in the number of occupied I/O points: Not required 4) Change in specifications Change in rated input voltage: Not required Change in rated input current: Required (Approx. 8.5mA → Approx. 6mA) Change in ON voltage/ON current: Required Change in OFF voltage/OFF current: Required Change in input resistance: Required 5) Change in functions : Not required

A/QnA series models to be discontinued		Q series alternative models	
Product	Model	Model	Remarks (restrictions)
Input module	AX40 (when using 24VDC)	QX40	1) Change in external wiring: Required 2) Change in the number of slots: Not required 3) Change in a program Change in the number of occupied I/O points: Not required 4) Change in specifications Change in rated input voltage: Not required Change in rated input current: Required (Approx. 10mA → Approx. 4mA) Change in ON voltage/ON current: Required Change in OFF voltage/OFF current: Required Change in input resistance: Required 5) Change in functions : Not required
	AX40 (when using 12VDC)	QX70	1) Change in external wiring: Required 2) Change in the number of slots: Not required 3) Change in a program Change in the number of occupied I/O points: Not required 4) Change in specifications Change in rated input voltage: Not required Change in rated input current: Required (Approx. 4mA → Approx. 3.3mA) Change in ON voltage/ON current: Required Change in OFF voltage/OFF current: Required Change in input resistance: Required 5) Change in functions : Not required
	AX40-UL (when using 24VDC)	QX40	1) Change in external wiring: Required 2) Change in the number of slots: Not required 3) Change in a program Change in the number of occupied I/O points: Not required 4) Change in specifications Change in rated input voltage: Not required Change in rated input current: Required (Approx. 10mA → Approx. 4mA) Change in ON voltage/ON current: Required Change in OFF voltage/OFF current: Required Change in input resistance: Required 5) Change in functions : Not required
	AX40-UL (when using 12VDC)	QX70	1) Change in external wiring: Required 2) Change in the number of slots: Not required 3) Change in a program Change in the number of occupied I/O points: Not required 4) Change in specifications Change in rated input voltage: Not required Change in rated input current: Required (Approx. 4mA → Approx. 3.3mA) Change in ON voltage/ON current: Required Change in OFF voltage/OFF current: Required Change in input resistance: Required 5) Change in functions : Not required

A/QnA series models to be discontinued		Q series alternative models	
Product	Model	Model	Remarks (restrictions)
Input module	AX41 (when using 24VDC)	QX41	1) Change in external wiring: Required (Connector terminal block must be converted.) 2) Change in the number of slots: Not required 3) Change in a program Change in the number of occupied I/O points: Not required 4) Change in specifications Change in rated input voltage: Not required Change in rated input current: Required (Approx. 10mA → Approx. 4mA) Change in ON voltage/ON current: Required Change in OFF voltage/OFF current: Required Change in input resistance: Required 5) Change in functions : Not required
		QX41-S2	1) Change in external wiring: Required (Connector terminal block must be converted.) 2) Change in the number of slots: Not required 3) Change in a program Change in the number of occupied I/O points: Not required 4) Change in specifications Change in rated input voltage: Not required Change in rated input current: Required (Approx. 10mA → Approx. 6mA) Change in ON voltage/ON current: Required Change in OFF voltage/OFF current: Required Change in input resistance: Required 5) Change in functions : Not required
	AX41 (when using 12VDC)	QX71	1) Change in external wiring: Required (Connector terminal block must be converted.) 2) Change in the number of slots: Not required 3) Change in a program Change in the number of occupied I/O points: Not required 4) Change in specifications Change in rated input voltage: Not required Change in rated input current: Required (Approx. 4mA → Approx. 3.3mA) Change in ON voltage/ON current: Required Change in OFF voltage/OFF current: Required Change in input resistance: Required 5) Change in functions : Not required
	AX41-S1 (when using 24VDC)	QX41-S1	1) Change in external wiring: Required (Connector terminal block must be converted.) 2) Change in the number of slots: Not required 3) Change in a program Change in the number of occupied I/O points: Not required 4) Change in specifications Change in rated input voltage: Not required Change in rated input current: Required (Approx. 10mA → Approx. 4mA) Change in ON voltage/ON current: Required Change in OFF voltage/OFF current: Required Change in input resistance: Required 5) Change in functions : Not required
	AX41-S1 (when using 12VDC)	QX71	1) Change in external wiring: Required (Connector terminal block must be converted.) 2) Change in the number of slots: Not required 3) Change in a program Change in the number of occupied I/O points: Not required 4) Change in specifications Change in rated input voltage: Not required Change in rated input current: Required (Approx. 4mA → Approx. 3.3mA) Change in ON voltage/ON current: Required Change in OFF voltage/OFF current: Required Change in input resistance: Required 5) Change in functions : Not required

A/QnA series models to be discontinued		Q series alternative models	
Product	Model	Model	Remarks (restrictions)
Input module	AX41-UL (when using 24VDC)	QX41	1) Change in external wiring: Required (Connector terminal block must be converted.) 2) Change in the number of slots: Not required 3) Change in a program Change in the number of occupied I/O points: Not required 4) Change in specifications Change in rated input voltage: Not required Change in rated input current: Required (Approx. 10mA → Approx. 4mA) Change in ON voltage/ON current: Required Change in OFF voltage/OFF current: Required Change in input resistance: Required 5) Change in functions : Not required
		QX41-S2	1) Change in external wiring: Required (Connector terminal block must be converted.) 2) Change in the number of slots: Not required 3) Change in a program Change in the number of occupied I/O points: Not required 4) Change in specifications Change in rated input voltage: Not required Change in rated input current: Required (Approx. 10mA → Approx. 6mA) Change in ON voltage/ON current: Required Change in OFF voltage/OFF current: Required Change in input resistance: Required 5) Change in functions : Not required
	AX41-UL (when using 12VDC)	QX71	1) Change in external wiring: Required (Connector terminal block must be converted.) 2) Change in the number of slots: Not required 3) Change in a program Change in the number of occupied I/O points: Not required 4) Change in specifications Change in rated input voltage: Not required Change in rated input current: Required (Approx. 4mA → Approx. 3.3mA) Change in ON voltage/ON current: Required Change in OFF voltage/OFF current: Required Change in input resistance: Required 5) Change in functions : Not required

A/QnA series models to be discontinued		Q series alternative models	
Product	Model	Model	Remarks (restrictions)
Input module	AX42 (when using 24VDC)	QX42	1) Change in external wiring: Not required 2) Change in the number of slots: Not required 3) Change in a program Change in the number of occupied I/O points: Not required 4) Change in specifications Change in rated input voltage: Not required Change in rated input current: Required (Approx. 7mA → Approx. 4mA) Change in ON voltage/ON current: Required Change in OFF voltage/OFF current: Required Change in input resistance: Required 5) Change in functions : Not required
		QX41-S2	1) Change in external wiring: Not required 2) Change in the number of slots: Required (2 modules are required.) 3) Change in a program Change in the number of occupied I/O points: Not required (64 points → 32 points × 2 modules) 4) Change in specifications Change in rated input voltage: Not required Change in rated input current: Required (Approx. 7mA → Approx. 6mA) Change in ON voltage/ON current: Required Change in OFF voltage/OFF current: Required Change in input resistance: Required 5) Change in functions : Not required
	AX42 (when using 12VDC)	QX72	1) Change in external wiring: Not required 2) Change in the number of slots: Not required 3) Change in a program Change in the number of occupied I/O points: Not required 4) Change in specifications Change in rated input voltage: Not required Change in rated input current: Required (Approx. 3mA → Approx. 3.3mA) Change in ON voltage/ON current: Required Change in OFF voltage/OFF current: Required Change in input resistance: Not required 5) Change in functions : Not required
	AX42-S1 (when using 24VDC)	QX42-S1	1) Change in external wiring: Not required 2) Change in the number of slots: Not required 3) Change in a program Change in the number of occupied I/O points: Not required 4) Change in specifications Change in rated input voltage: Not required Change in rated input current: Required (Approx. 7mA → Approx. 4mA) Change in ON voltage/ON current: Required Change in OFF voltage/OFF current: Required Change in input resistance: Required 5) Change in functions : Not required
	AX42-S1 (when using 12VDC)	QX72	1) Change in external wiring: Not required 2) Change in the number of slots: Not required 3) Change in a program Change in the number of occupied I/O points: Not required 4) Change in specifications Change in rated input voltage: Not required Change in rated input current: Required (Approx. 3mA → Approx. 3.3mA) Change in ON voltage/ON current: Required Change in OFF voltage/OFF current: Required Change in input resistance: Required 5) Change in functions : Not required

A/QnA series models to be discontinued		Q series alternative models	
Product	Model	Model	Remarks (restrictions)
Input module	AX50(S1)	QX50	1) Change in external wiring: Required 2) Change in the number of slots : Not required 3) Change in a program Change in the number of occupied I/O points: Not required 4) Change in specifications Change in rated input voltage : Not required Change in rated input current : Not required Change in ON voltage/ON current: Required Change in OFF voltage/OFF current: Not required Change in input resistance : Required 5) Change in functions : Not required
	AX60/AX60-S1	None	Alternating with the QX40+FA-TH16X100D31L is recommended. The FA-TH16X100D31L is the FA goods manufactured by Mitsubishi Electric Engineering Co., Ltd.
	AX70 (when using 24VDC and positive common)	QX40	1) Change in external wiring: Required 2) Change in the number of slots: Not required 3) Change in a program Change in the number of occupied I/O points: Not required 4) Change in specifications Change in rated input voltage: Not required Change in rated input current: Required (Approx. 6mA → Approx. 4mA) Change in ON voltage/ON current: Required Change in OFF voltage/OFF current: Required Change in input resistance: Required 5) Change in functions : Not required
	AX70 (when using 24VDC and negative common)	QX80	1) Change in external wiring: Required 2) Change in the number of slots: Not required 3) Change in a program Change in the number of occupied I/O points: Not required 4) Change in specifications Change in rated input voltage: Not required Change in rated input current: Required (Approx. 4.5mA → Approx. 4mA) Change in ON voltage/ON current: Required Change in OFF voltage/OFF current: Required Change in input resistance: Required 5) Change in functions : Not required
	AX70 (when using 5/12VDC)	QX70	1) Change in external wiring: Required 2) Change in the number of slots: Not required 3) Change in a program Change in the number of occupied I/O points: Not required 4) Change in specifications Change in rated input voltage: Not required Change in rated input current: Required (Approx. 3.5/2mA → Approx. 1.2/3.3mA) Change in ON voltage/ON current: Required Change in OFF voltage/OFF current: Required Change in input resistance: Required 5) Change in functions : Not required
	AX70-UL (when using 24VDC and positive common)	QX40	1) Change in external wiring: Required 2) Change in the number of slots: Not required 3) Change in a program Change in the number of occupied I/O points: Not required 4) Change in specifications Change in rated input voltage: Not required Change in rated input current: Required (Approx. 4.5mA → Approx. 4mA) Change in ON voltage/ON current: Required Change in OFF voltage/OFF current: Required Change in input resistance: Required 5) Change in functions : Not required

A/QnA series models to be discontinued		Q series alternative models	
Product	Model	Model	Remarks (restrictions)
Input module	AX70-UL (when using 24VDC and negative common)	QX80	1) Change in external wiring: Required
			2) Change in the number of slots: Not required
	AX70-UL (when using 5/12VDC)	QX70	3) Change in a program
			4) Change in specifications
	AX71 (when using 24VDC and positive common)	QX41	Change in the number of occupied I/O points: Not required
			5) Change in functions : Not required
AX71 (when using 24VDC and positive common)	QX41-S2	Change in rated input voltage: Not required	
		Change in rated input current: Required (Approx. 4.5mA → Approx. 6mA)	
		Change in ON voltage/ON current: Required	
		Change in OFF voltage/OFF current: Required	
		Change in input resistance: Required	
		5) Change in functions: Not required	

A/QnA series models to be discontinued		Q series alternative models	
Product	Model	Model	Remarks (restrictions)
Input module	AX71 (when using 24VDC and negative common)	QX81	1) Change in external wiring: Required (Connector terminal block must be converted.) 2) Change in the number of slots: Not required 3) Change in a program Change in the number of occupied I/O points: Not required 4) Change in specifications Change in rated input voltage: Not required Change in rated input current: Required (Approx. 4.5mA → Approx. 6mA) Change in ON voltage/ON current: Required Change in OFF voltage/OFF current: Required Change in input resistance: Required 5) Change in functions: Not required
		QX81-S2	1) Change in external wiring: Required (Connector terminal block must be converted.) 2) Change in the number of slots: Not required 3) Change in a program Change in the number of occupied I/O points: Not required 4) Change in specifications Change in rated input voltage: Not required Change in rated input current: Required (Approx. 4.5mA → Approx. 6mA) Change in ON voltage/ON current: Required Change in OFF voltage/OFF current: Required Change in input resistance: Required 5) Change in functions: Not required
	AX71 (when using 5/12VDC)	QX71	1) Change in external wiring: Required (Connector terminal block must be converted.) 2) Change in the number of slots: Not required 3) Change in a program Change in the number of occupied I/O points: Not required 4) Change in specifications Change in rated input voltage: Not required Change in rated input current: Required (Approx. 3.5/2mA → Approx. 1.2/3.3mA) Change in ON voltage/ON current: Required Change in OFF voltage/OFF current: Required Change in input resistance: Required 5) Change in functions: Not required
	AX80 (when using 24VDC)	QX80	1) Change in external wiring: Required 2) Change in the number of slots: Not required 3) Change in a program Change in the number of occupied I/O points: Not required 4) Change in specifications Change in rated input voltage: Not required Change in rated input current: Required (Approx. 10mA → Approx. 6mA) Change in ON voltage/ON current: Required Change in OFF voltage/OFF current: Required Change in input resistance: Required 5) Change in functions : Not required
	AX80 (when using 12VDC)	QX70	1) Change in external wiring: Required 2) Change in the number of slots: Not required 3) Change in a program Change in the number of occupied I/O points: Not required 4) Change in specifications Change in rated input voltage: Not required Change in rated input current: Required (Approx. 4mA → Approx. 3.3mA) Change in ON voltage/ON current: Required Change in OFF voltage/OFF current: Required Change in input resistance: Required 5) Change in functions : Not required

A/QnA series models to be discontinued		Q series alternative models	
Product	Model	Model	Remarks (restrictions)
Input module	AX80-UL (when using 24VDC)	QX80	1) Change in external wiring: Required 2) Change in the number of slots: Not required 3) Change in a program Change in the number of occupied I/O points: Not required 4) Change in specifications Change in rated input voltage: Not required Change in rated input current: Required (Approx. 10mA → Approx. 4mA) Change in ON voltage/ON current: Required Change in OFF voltage/OFF current: Required Change in input resistance: Required 5) Change in functions : Not required
	AX80-UL (when using 12VDC)	QX70	1) Change in external wiring: Required 2) Change in the number of slots: Not required 3) Change in a program Change in the number of occupied I/O points: Not required 4) Change in specifications Change in rated input voltage: Not required Change in rated input current: Required (Approx. 4mA → Approx. 3.3mA) Change in ON voltage/ON current: Required Change in OFF voltage/OFF current: Required Change in input resistance: Required 5) Change in functions : Not required
	AX80E (when using 24VDC)	QX82-S1	1) Change in external wiring: Required (Connector terminal block must be converted.) 2) Change in the number of slots: Not required 3) Change in a program Change in the number of occupied I/O points: Not required 4) Change in specifications Change in rated input voltage: Not required Change in rated input current: Required (Approx. 10mA → Approx. 4mA) Change in ON voltage/ON current: Required Change in OFF voltage/OFF current: Required Change in input resistance: Required 5) Change in functions : Not required
	AX80E (when using 12VDC)	QX70	1) Change in external wiring: Required 2) Change in the number of slots: Not required 3) Change in a program Change in the number of occupied I/O points: Not required 4) Change in specifications Change in rated input voltage: Not required Change in rated input current: Required (Approx. 4mA → Approx. 3.3mA) Change in ON voltage/ON current: Required Change in OFF voltage/OFF current: Required Change in input resistance: Required 5) Change in functions : Not required

A/QnA series models to be discontinued		Q series alternative models	
Product	Model	Model	Remarks (restrictions)
Input module	AX81 (when using 24VDC)	QX81	1) Change in external wiring: Required (Connector terminal block must be converted.) 2) Change in the number of slots: Not required 3) Change in a program Change in the number of occupied I/O points: Not required 4) Change in specifications Change in rated input voltage: Not required Change in rated input current: Required (Approx. 10mA → Approx. 4mA) Change in ON voltage/ON current: Required Change in OFF voltage/OFF current: Required Change in input resistance: Required 5) Change in functions: Not required
		QX81-S2	1) Change in external wiring: Required (Connector terminal block must be converted.) 2) Change in the number of slots: Not required 3) Change in a program Change in the number of occupied I/O points: Not required 4) Change in specifications Change in rated input voltage: Not required Change in rated input current: Required (Approx. 10mA → Approx. 6mA) Change in ON voltage/ON current: Required Change in OFF voltage/OFF current: Required Change in input resistance: Required 5) Change in functions: Not required
	AX81 (when using 12VDC)	QX71	1) Change in external wiring: Required (Connector terminal block must be converted.) 2) Change in the number of slots: Not required 3) Change in a program Change in the number of occupied I/O points: Not required 4) Change in specifications Change in rated input voltage: Not required Change in rated input current: Required (Approx. 4mA → Approx. 3.3mA) Change in ON voltage/ON current: Required Change in OFF voltage/OFF current: Required Change in input resistance: Required 5) Change in functions: Not required
	AX81B	None	Alternating with QX81 is recommended. 1) Change in external wiring: Required (Connector terminal block must be converted.) 2) Change in the number of slots: Not required 3) Change in a program Change in the number of occupied I/O points: Required 4) Change in specifications Change in rated input voltage: Not required Change in rated input current: Required (Approx. 7mA → Approx. 4mA) Change in ON voltage/ON current: Required Change in OFF voltage/OFF current: Required Change in input resistance: Required 5) Change in functions : The wire breakage detection function not provided

A/QnA series models to be discontinued		Q series alternative models	
Product	Model	Model	Remarks (restrictions)
Input module	AX81-S1 (when using 24VDC and positive common)	QX41	1) Change in external wiring: Required (Connector terminal block must be converted.) 2) Change in the number of slots: Not required 3) Change in a program Change in the number of occupied I/O points: Not required 4) Change in specifications Change in rated input voltage: Not required Change in rated input current: Required (Approx. 5mA → Approx. 4mA) Change in ON voltage/ON current: Required Change in OFF voltage/OFF current: Required Change in input resistance: Required 5) Change in functions: Not required
		QX41-S2	1) Change in external wiring: Required (Connector terminal block must be converted.) 2) Change in the number of slots: Not required 3) Change in a program Change in the number of occupied I/O points: Not required 4) Change in specifications Change in rated input voltage: Not required Change in rated input current: Required (Approx. 5mA → Approx. 6mA) Change in ON voltage/ON current: Required Change in OFF voltage/OFF current: Required Change in input resistance: Required 5) Change in functions: Not required
	AX81-S1 (when using 24VDC and negative common)	QX81	1) Change in external wiring: Required (Connector terminal block must be converted.) 2) Change in the number of slots: Not required 3) Change in a program Change in the number of occupied I/O points: Not required 4) Change in specifications Change in rated input voltage: Not required Change in rated input current: Required (Approx. 5mA → Approx. 4mA) Change in ON voltage/ON current: Required Change in OFF voltage/OFF current: Required Change in input resistance: Required 5) Change in functions : Not required
		QX81-S2	1) Change in external wiring: Required (Connector terminal block must be converted.) 2) Change in the number of slots: Not required 3) Change in a program Change in the number of occupied I/O points: Not required 4) Change in specifications Change in rated input voltage: Not required Change in rated input current: Required (Approx. 5mA → Approx. 6mA) Change in ON voltage/ON current: Required Change in OFF voltage/OFF current: Required Change in input resistance: Required 5) Change in functions : Not required
	AX81-S1 (when using 12VDC)	QX71	1) Change in external wiring: Required (Connector terminal block must be converted.) 2) Change in the number of slots: Not required 3) Change in a program Change in the number of occupied I/O points: Not required 4) Change in specifications Change in rated input voltage: Not required Change in rated input current: Required (Approx. 2.5mA → Approx. 3.3mA) Change in ON voltage/ON current: Required Change in OFF voltage/OFF current: Required Change in input resistance: Required 5) Change in functions : Not required

A/QnA series models to be discontinued		Q series alternative models	
Product	Model	Model	Remarks (restrictions)
Input module	AX81-S2 (when using 48VDC)	QX50	1) Change in external wiring: Required 2) Change in the number of slots: Required (2 modules are required.) 3) Change in a program Change in the number of occupied I/O points: Not required (32 points → 16 points × 2 modules) 4) Change in specifications Change in rated input voltage: Not required Change in rated input current: Required (Approx. 3mA → Approx. 4mA) Change in ON voltage/ON current: Required Change in OFF voltage/OFF current: Required Change in input resistance: Required 5) Change in functions : Not required
	AX81-S2 (when using 60VDC)	None	Alternating with QX81 is recommended. 1) Change in external wiring: Required (Connector terminal block must be converted.) Connect the 8.2kΩ (1W or more) resistor serially to the external signal wire. 2) Change in the number of slots: Not required 3) Change in a program Change in the number of occupied I/O points: Not required 4) Change in specifications Change in rated input voltage: Not required Change in rated input current: Not required Change in ON voltage/ON current: Required Change in OFF voltage/OFF current: Required Change in input resistance: Required 5) Change in functions : Not required
	AX81-S3 (when using 24VDC)	QX82-S1	1) Change in external wiring: Required (Connector terminal block must be converted.) 2) Change in the number of slots: Not required 3) Change in a program Change in the number of occupied I/O points: Required 4) Change in specifications Change in rated input voltage: Not required Change in rated input current: Required (Approx. 10mA → Approx. 4mA) Change in ON voltage/ON current: Required Change in OFF voltage/OFF current: Required Change in input resistance: Required 5) Change in functions : Not required
	AX81-S3 (when using 12VDC)	QX71	1) Change in external wiring: Required (Connector terminal block must be converted.) 2) Change in the number of slots: Not required 3) Change in a program Change in the number of occupied I/O points: Not required 4) Change in specifications Change in rated input voltage: Not required Change in rated input current: Required (Approx. 4mA → Approx. 3.3mA) Change in ON voltage/ON current: Required Change in OFF voltage/OFF current: Required Change in input resistance: Required 5) Change in functions : Not required

A/QnA series models to be discontinued		Q series alternative models	
Product	Model	Model	Remarks (restrictions)
Input module	AX82 (when using 24VDC)	QX82	1) Change in external wiring: Required (37 pin D-sub connector → 40-pin connector) 2) Change in the number of slots: Not required 3) Change in a program Change in the number of occupied I/O points: Not required 4) Change in specifications Change in rated input voltage: Not required Change in rated input current: Required (Approx. 7mA → Approx. 4mA) Change in ON voltage/ON current: Required Change in OFF voltage/OFF current: Required Change in input resistance: Required 5) Change in functions : Not required
		QX81-S2	1) Change in external wiring: Required (Connector shell must be replaced.) 2) Change in the number of slots: Required (2 modules are required.) 3) Change in a program Change in the number of occupied I/O points: Not required (64 points → 32 points × 2 modules) 4) Change in specifications Change in rated input voltage: Not required Change in rated input current: Required (Approx. 7mA → Approx. 6mA) Change in ON voltage/ON current: Required Change in OFF voltage/OFF current: Required Change in input resistance: Required 5) Change in functions : Not required
	AX82 (when using 12VDC)	QX72	1) Change in external wiring: Required (37 pin D-sub connector → 40-pin connector) 2) Change in the number of slots: Not required 3) Change in a program Change in the number of occupied I/O points: Not required 4) Change in specifications Change in rated input voltage: Not required Change in rated input current: Required (Approx. 3mA → Approx. 3.3mA) Change in ON voltage/ON current: Required Change in OFF voltage/OFF current: Required Change in input resistance: Required 5) Change in functions : Not required

A/QnA series models to be discontinued		Q series alternative models	
Product	Model	Model	Remarks (restrictions)
Output module	AY10	QY10	1) Change in external wiring: Required 2) Change in the number of slots: Not required 3) Change in a program Change in the number of occupied I/O points: Not required 4) Change in specifications Change in rated output voltage: Not required Change in rated output current: Not required (However, contact life span is reduced to half.) 5) Change in functions : Not required
	AY10A	QY18A* ¹	1) Change in external wiring: Required 2) Change in the number of slots: Required (2 modules required) 3) Change in a program Change in the number of occupied I/O points: Required (16 points → 32 points (16 points × 2 modules)) Change in the number of output points: 16 points × 1 module → 8 points × 2 modules 4) Change in specifications Change in rated output voltage: Not required Change in rated output current: Not required (However, contact life span is reduced to half.) 5) Change in functions : Not required
	AY10A-UL	QY18A* ¹	1) Change in external wiring: Required 2) Change in the number of slots: Required (2 modules required) 3) Change in a program Change in the number of occupied I/O points: Required (16 points → 32 points (16 points × 2 modules)) Change in the number of output points: 16 points × 1 module → 8 points × 2 modules 4) Change in specifications Change in rated output voltage: Not required Change in rated output current: Not required (However, contact life span is reduced to half.) 5) Change in functions : Not required
	AY11	QY10	1) Change in external wiring: Required 2) Change in the number of slots: Not required 3) Change in a program Change in the number of occupied I/O points: Not required 4) Change in specifications Change in rated output voltage: Not required Change in rated output current: Not required (However, contact life span is reduced to half.) 5) Change in functions : Required (No varistor, relay not replaceable)
	AY11A	QY18A* ¹	1) Change in external wiring: Required 2) Change in the number of slots: Required (2 modules required) 3) Change in a program Change in the number of occupied I/O points: Required (16 points → 32 points (16 points × 2 modules)) Change in the number of output points: 16 points × 1 module → 8 points × 2 modules 4) Change in specifications Change in rated output voltage: Not required Change in rated output current: Not required (However, contact life span is reduced to half.) 5) Change in functions : Required (No varistor)
	AY11AEU	QY18A* ¹	1) Change in external wiring: Required 2) Change in the number of slots: Required (2 modules required) 3) Change in a program Change in the number of occupied I/O points: Required (16 points → 32 points (16 points × 2 modules)) Change in the number of output points: 16 points × 1 module → 8 points × 2 modules 4) Change in specifications Change in rated output voltage: Not required Change in rated output current: Not required (However, contact life span is reduced to half.) 5) Change in functions : Required (No varistor)

A/QnA series models to be discontinued		Q series alternative models	
Product	Model	Model	Remarks (restrictions)
Output module	AY11E	QY10	1) Change in external wiring: Required 2) Change in the number of slots: Not required 3) Change in a program Change in the number of occupied I/O points: Not required 4) Change in specifications Change in rated output voltage: Not required Change in rated output current: Not required (However, contact life span is reduced to half.) 5) Change in functions : Required (No fuse, no varistor)
	AY11EEU	QY10	1) Change in external wiring: Required 2) Change in the number of slots: Not required 3) Change in a program Change in the number of occupied I/O points: Not required 4) Change in specifications Change in rated output voltage: Not required Change in rated output current: Not required (However, contact life span is reduced to half.) 5) Change in functions : Required (No fuse, no varistor)
	AY11-UL	QY10	1) Change in external wiring: Required 2) Change in the number of slots: Not required 3) Change in a program Change in the number of occupied I/O points: Not required 4) Change in specifications Change in rated output voltage: Not required Change in rated output current: Not required (However, contact life span is reduced to half.) 5) Change in functions : Required (No varistor)
	AY13	QY10*1	1) Change in external wiring: Required 2) Change in the number of slots: Required (2 modules required) 3) Change in a program Change in the number of occupied I/O points: Not required (32 = 16 × 2) 4) Change in specifications Change in rated output voltage: Not required Change in rated output current: Not required (However, contact life span is reduced to half.) 5) Change in functions : Not required
	AY13E	QY10*1	1) Change in external wiring: Required 2) Change in the number of slots: Required (2 modules required) 3) Change in a program Change in the number of occupied I/O points: Not required (32 = 16 × 2) 4) Change in specifications Change in rated output voltage: Not required Change in rated output current: Not required (However, contact life span is reduced to half.) 5) Change in functions : Required (No fuse)
	AY13EU	QY10*1	1) Change in external wiring: Required 2) Change in the number of slots: Required (2 modules required) 3) Change in a program Change in the number of occupied I/O points: Not required (32=16 × 2) 4) Change in specifications Change in rated output voltage: Not required Change in rated output current: Not required (However, contact life span is reduced to half.) 5) Change in functions : Not required
	AY15EU	QY10	1) Change in external wiring: Required 2) Change in the number of slots: Required (2 modules required) 3) Change in a program Change in the number of occupied I/O points: Not required 4) Change in specifications Change in rated output voltage: Not required Change in rated output current: Not required (However, contact life span is reduced to half.) 5) Change in functions: Not required

A/QnA series models to be discontinued		Q series alternative models	
Product	Model	Model	Remarks (restrictions)
Output module	AY22	QY22	1) Change in external wiring: Required 2) Change in the number of slots: Not required 3) Change in a program Change in the number of occupied I/O points: Not required 4) Change in specifications Change in rated output voltage: Not required Change in rated output current: Required (from 2A to 0.6A) 5) Change in functions : Required (No fuse, no varistor)
	AY23	QY22 ^{*1}	1) Change in external wiring: Required 2) Change in the number of slots: Required (2 modules required) 3) Change in a program Change in the number of occupied I/O points: Not required (32 = 16 × 2) 4) Change in specifications Change in rated output voltage: Not required Change in rated output current: Not required 5) Change in functions : Required (No fuse)
	AY40		1) Change in external wiring: Required 2) Change in the number of slots: Not required 3) Change in a program Change in the number of occupied I/O points: Not required 4) Change in specifications Change in rated output voltage: Not required Change in rated output current: Not required 5) Change in functions : Required (Protection function equipped)
	AY40-UL	QY40P	1) Change in external wiring: Required 2) Change in the number of slots: Not required 3) Change in a program Change in the number of occupied I/O points: Not required 4) Change in specifications Change in rated output voltage: Not required Change in rated output current: Not required 5) Change in functions : Required (Protection function equipped)
	AY40P		1) Change in external wiring: Required 2) Change in the number of slots: Not required 3) Change in a program Change in the number of occupied I/O points: Not required 4) Change in specifications Change in rated output voltage: Not required Change in rated output current: Not required 5) Change in functions : Not required
	AY40A	QY68A	1) Change in external wiring: Required 2) Change in the number of slots: Required (2 modules required) 3) Change in a program Change in the number of occupied I/O points: Required (16 points → 32 points (16 points × 2 modules)) Change in the number of output points: 16 points × 1 module → 8 points × 2 modules 4) Change in specifications Change in rated output voltage: Not required Change in rated output current: Not required Response: Slow 5) Change in functions : Not required

A/QnA series models to be discontinued		Q series alternative models	
Product	Model	Model	Remarks (restrictions)
Output module	AY41	QY41P*1	1) Change in external wiring: Required (Connector terminal block must be converted.) 2) Change in the number of slots: Not required 3) Change in a program Change in the number of occupied I/O points: Not required 4) Change in specifications Change in rated output voltage: Not required Change in rated output current: Not required 5) Change in functions : Required (Protection function equipped)
	AY41P		1) Change in external wiring: Required (Connector terminal block must be converted.) 2) Change in the number of slots: Not required 3) Change in a program Change in the number of occupied I/O points: Not required 4) Change in specifications Change in rated output voltage: Not required Change in rated output current: Not required 5) Change in functions : Not required
	AY41-UL	QY41P*1	1) Change in external wiring: Required (Connector terminal block must be converted.) 2) Change in the number of slots: Not required 3) Change in a program Change in the number of occupied I/O points: Not required 4) Change in specifications Change in rated output voltage: Not required Change in rated output current: Not required 5) Change in functions : Required (Protection function equipped)
	AY42	QY42P	1) Change in external wiring: Not required 2) Change in the number of slots: Not required 3) Change in a program Change in the number of occupied I/O points: Not required 4) Change in specifications Change in rated output voltage: Not required Change in rated output current: Not required 5) Change in functions : Required (Protection function equipped)
	AY42-S1	QY42P	1) Change in external wiring: Not required 2) Change in the number of slots: Not required 3) Change in a program Change in the number of occupied I/O points: Not required 4) Change in specifications Change in rated output voltage: Not required Change in rated output current: Not required Response time: Required (0.3ms or less → 1ms or less) 5) Change in functions: Required (Protection function equipped)
	AY42-S3	QY42P	1) Change in external wiring: Not required 2) Change in the number of slots: Not required 3) Change in a program Change in the number of occupied I/O points: Not required 4) Change in specifications Change in rated output voltage: Not required Change in rated output current: Not required 5) Change in functions : Required (The short protection function is equivalent to a fuse)
	AY42-S4	QY42P	1) Change in external wiring: Required (External power supply required) 2) Change in the number of slots: Not required 3) Change in a program Change in the number of occupied I/O points: Not required 4) Change in specifications Change in rated output voltage: Not required Change in rated output current: Not required 5) Change in functions : Required (Protection function equipped)

A/QnA series models to be discontinued		Q series alternative models	
Product	Model	Model	Remarks (restrictions)
Output module	AY50	QY50	1) Change in external wiring: Required 2) Change in the number of slots: Not required 3) Change in a program Change in the number of occupied I/O points: Not required 4) Change in specifications Change in rated output voltage: Not required Change in rated output current: Not required 5) Change in functions : Required (Fuse not replaceable)
	AY50-UL		1) Change in external wiring: Required 2) Change in the number of slots: Not required 3) Change in a program Change in the number of occupied I/O points: Not required 4) Change in specifications Change in rated output voltage: Not required Change in rated output current: Not required 5) Change in functions : Required (Fuse not replaceable)
	AY51	QY50*1	1) Change in external wiring: Required 2) Change in the number of slots: Required (2 modules required) 3) Change in a program Change in the number of occupied I/O points: Not required (32=16 × 2) 4) Change in specifications Change in rated output voltage: Not required Change in rated output current: Not required 5) Change in functions : Not required
	AY51-S1	QY50*1	1) Change in external wiring: Required 2) Change in the number of slots: Required (2 modules required) 3) Change in a program Change in the number of occupied I/O points: Not required (32=16 × 2) 4) Change in specifications Change in rated output voltage: Not required Change in rated output current: Not required 5) Change in functions : Required (Fuse not replaceable)
	AY51-UL	QY50*1	1) Change in external wiring: Required 2) Change in the number of slots: Required (2 modules required) 3) Change in a program Change in the number of occupied I/O points: Not required (32 = 16 × 2) 4) Change in specifications Change in rated output voltage: Not required Change in rated output current: Not required 5) Change in functions : Not required
	AY60	QY68A	1) Change in external wiring: Required 2) Change in the number of slots: Required (2 modules required) 3) Change in a program Change in the number of occupied I/O points: Required (16 points → 32 points (16 points × 2 modules)) Change in the number of output points: 16 points × 1 module → 8 points × 2 modules 4) Change in specifications Change in rated output voltage: Required (48VDC not applicable) Change in rated output current: Not required 5) Change in functions : Required (Fuse not replaceable, independent common)

A/QnA series models to be discontinued		Q series alternative models	
Product	Model	Model	Remarks (restrictions)
Output module	AY60E	QY68A	1) Change in external wiring: Required 2) Change in the number of slots: Required (2 modules required) 3) Change in a program Change in the number of occupied I/O points: Required (16 points → 32 points (16 points × 2 modules)) Change in the number of output points: 16 points × 1 module → 8 points × 2 modules 4) Change in specifications Change in rated output voltage: Required (48VDC not applicable) Change in rated output current: Not required 5) Change in functions : Required (No fuse, independent common)
	AY60EP		1) Change in external wiring: Required 2) Change in the number of slots: Required (2 modules required) 3) Change in a program Change in the number of occupied I/O points: Required (16 points → 32 points (16 points × 2 modules)) Change in the number of output points: 16 points × 1 module → 8 points × 2 modules 4) Change in specifications Change in rated output voltage: Not required Change in rated output current: Not required 5) Change in functions : Required (Fuse → protection function, independent common)
	AY60S		1) Change in external wiring: Required 2) Change in the number of slots: Required (2 modules required) 3) Change in a program Change in the number of occupied I/O points: Required (16 points → 32 points (16 points × 2 modules)) Change in the number of output points: 16 points × 1 module → 8 points × 2 modules 4) Change in specifications Change in rated output voltage: Required (48VDC not applicable) Change in rated output current: Not required 5) Change in functions : Required (No fuse, independent common)
	AY60S-UL		1) Change in external wiring: Required 2) Change in the number of slots: Required (2 modules required) 3) Change in a program Change in the number of occupied I/O points: Required (16 points → 32 points (16 points × 2 modules)) Change in the number of output points: 16 points × 1 module → 8 points × 2 modules 4) Change in specifications Change in rated output voltage: Not required Change in rated output current: Not required 5) Change in functions : Required (No fuse, independent common)
	AY70	QY70	1) Change in external wiring: Required 2) Change in the number of slots: Not required 3) Change in a program Change in the number of occupied I/O points: Not required 4) Change in specifications Change in rated output voltage: Not required Change in rated output current: Not required 5) Change in functions: Required (no fuse → fuse equipped)
	AY70-UL		1) Change in external wiring: Required 2) Change in the number of slots: Not required 3) Change in a program Change in the number of occupied I/O points: Not required 4) Change in specifications Change in rated output voltage: Not required Change in rated output current: Not required 5) Change in functions: Required (no fuse → fuse equipped)
	AY71	QY71	1) Change in external wiring: Required (Connector terminal block must be converted.) 2) Change in the number of slots: Not required 3) Change in a program Change in the number of occupied I/O points: Not required 4) Change in specifications Change in rated output voltage: Not required Change in rated output current: Not required 5) Change in functions: Required (no fuse → fuse equipped)

A/QnA series models to be discontinued		Q series alternative models	
Product	Model	Model	Remarks (restrictions)
Output module	AY72	QY71	1) Change in external wiring: Not required 2) Change in the number of slots: Required (2 modules required) 3) Change in a program Change in the number of occupied I/O points: Not required (64 points → 32 points × 2 modules) 4) Change in specifications Change in rated output voltage: Not required Change in rated output current: Not required 5) Change in functions: Required (no fuse → fuse equipped)
	AY80	QY80	1) Change in external wiring: Required 2) Change in the number of slots: Not required 3) Change in a program Change in the number of occupied I/O points: Not required 4) Change in specifications Change in rated output voltage: Not required Change in rated output current: Not required 5) Change in functions : Required (Fuse not replaceable)
	AY81	QY80	1) Change in external wiring: Required 2) Change in the number of slots: Required (2 modules required) 3) Change in a program Change in the number of occupied I/O points: Not required (32 points → 16 points × 2 modules) 4) Change in specifications Change in rated output voltage: Not required Change in rated output current: Not required 5) Change in functions : Required (no varistor, fuse equipped)
		QY81P	1) Change in external wiring: Required (Connector terminal block must be converted.) 2) Change in the number of slots: Not required 3) Change in a program Change in the number of occupied I/O points: Not required 4) Change in specifications Change in rated output voltage: Not required Change in rated output current: Required (from 0.5A to 0.1A) 5) Change in functions : Not required
	AY81EP	QY80	1) Change in external wiring: Required 2) Change in the number of slots: Required (2 modules required) 3) Change in a program Change in the number of occupied I/O points: Not required (32 points → 16 points × 2 modules) 4) Change in specifications Change in rated output voltage: Not required Change in rated output current: Required (from 0.8A to 0.5A) 5) Change in functions : Required (no protection function, fuse equipped)
		QY81P	1) Change in external wiring: Required (Connector terminal block must be converted.) 2) Change in the number of slots: Not required 3) Change in a program Change in the number of occupied I/O points: Not required 4) Change in specifications Change in rated output voltage: Not required Change in rated output current: Required (from 0.5A to 0.1A) 5) Change in functions : Not required

A/QnA series models to be discontinued		Q series alternative models	
Product	Model	Model	Remarks (restrictions)
Output module	AY82EP	QY81P	1) Change in external wiring: Required (Connector shell must to be replaced) 2) Change in the number of slots: Required (2 modules required) 3) Change in a program Change in the number of occupied I/O points: Not required (64 points → 32 points × 2 modules) 4) Change in specifications Change in rated output voltage: Not required Change in rated output current: Not required 5) Change in functions : Not required
		QY82P	1) Change in external wiring: Required (37-pin connector → 40-pin connector) 2) Change in the number of slots: Not required 3) Change in a program Change in the number of occupied I/O points: Not required 4) Change in specifications Change in rated output voltage: Not required Change in rated output current: Not required 5) Change in functions : Not required
I/O module	AH42	QH42P	1) Change in external wiring: Not required 2) Change in the number of slots: Not required 3) Change in a program Change in the number of occupied I/O points: Required (32 points occupied) 4) Change in specifications Change in rated input voltage: Required (12VDC not applicable) Change in rated input current: Required (Approx. 7mA → Approx. 4mA) Change in ON voltage/ON current: Required Change in OFF voltage/OFF current: Required Change in input resistance: Required 5) Change in functions : Required (Protection function equipped)
		QX41Y41P	1) Change in external wiring: Not required 2) Change in the number of slots: Not required 3) Change in a program Change in the number of occupied I/O points: Not required (64 points occupied) 4) Change in specifications Change in rated input voltage: Required (12VDC not applicable) Change in rated input current: Required (Approx. 7mA → Approx. 4mA) Change in ON voltage/ON current: Required Change in OFF voltage/OFF current: Required Change in input resistance: Required 5) Change in functions : Required (Protection function equipped)
Dynamic scan I/O module	A42XY	None	Use both QX42 and QY42P after converting I/O signal from dynamic to static.
Dummy module	AG62	None	[Dummy module function] Alternating with QG60 and I/O assignment setting is recommended. [Simulation switch function] Alternating with QX40 and external switch is recommended.
Blank cover	AG60	QG60	No restrictions

A/QnA series models to be discontinued		Q series alternative models	
Product	Model	Model	Remarks (restrictions)
Interrupt module	AI61	QI60	1) Change in external wiring: Required 2) Change in the number of slots: Not required 3) Change in a program Change in the number of occupied I/O points: Required (32 points → 16 points) 4) Change in specifications Change in rated input voltage: Required (12VDC not applicable) Change in rated input current: Required (Approx. 14mA → Approx. 6mA) Change in ON voltage/ON current: Required Change in OFF voltage/OFF current: Required Change in input resistance: Required 5) Change in functions : Not required
	AI61-S1	QI60	1) Change in external wiring: Required 2) Change in the number of slots: Not required 3) Change in a program Change in the number of occupied I/O points: Required (32 points → 16 points) 4) Change in specifications Change in rated input voltage: Not required Change in rated input current: Required (Approx. 14mA → Approx. 6mA) Change in ON voltage/ON current: Required Change in OFF voltage/OFF current: Required Change in input resistance: Required 5) Change in functions : Not required 6) Others: The response time is different.

*1 Replacing with the Q series large type I/O module is possible. For details, refer to Section 3.1.2.

3.1.2 List of alternative Q series large type module models

A/QnA series models to be discontinued		Q series alternative models	
Product	Model	Model	Remarks (restrictions)
Input module	AX11	QX11L	1) Change in external wiring: Not required (Existing terminal block can be utilized.) 2) Change in the number of slots: Not required 3) Change in a program Change in the number of occupied I/O points: Not required
	AX21	QX21L	4) Change in specifications Change in rated input voltage: Not required Change in rated input current: Not required Change in ON voltage/ON current: Not required Change in OFF voltage/OFF current: Required Change in input resistance: Not required 5) Change in functions : Not required
Output module	AY10A	QY11AL	1) Change in external wiring: Not required (Existing terminal block can be utilized.) 2) Change in the number of slots: Not required 3) Change in a program Change in the number of occupied I/O points: Not required 4) Change in specifications Change in rated input voltage: Not required Change in rated input current: Not required Change in leakage current at OFF AY10A → QY11AL: Required (0mA → 0.1mA) AY11A → QY11AL: Not required (0.1mA)
	AY11A		5) Change in functions AY10A → QY11AL: Required (Varistor Not required → required) AY11A → QY11AL: Not required (Varistor Required)
	AY11AEU		1) Change in external wiring: Not required (Existing terminal block can be utilized.) 2) Change in the number of slots: Not required 3) Change in a program Change in the number of occupied I/O points: Not required 4) Change in specifications Change in rated input voltage: Not required Change in rated input current: Not required 5) Change in functions : Not required
	AY13	QY13L	1) Change in external wiring: Not required (Existing terminal block can be utilized.) 2) Change in the number of slots: Not required 3) Change in a program Change in the number of occupied I/O points: Not required 4) Change in specifications Change in rated input voltage: Not required Change in rated input current: Not required 5) Change in functions : Not required
	AY13E	QY13L	1) Change in external wiring: Not required (Existing terminal block can be utilized.) 2) Change in the number of slots: Not required 3) Change in a program Change in the number of occupied I/O points: Not required 4) Change in specifications Change in rated input voltage: Not required Change in rated input current: Not required 5) Change in functions : Required (Fuse (per common) → None)
	AY13EU		1) Change in external wiring: Not required (Existing terminal block can be utilized.) 2) Change in the number of slots: Not required 3) Change in a program Change in the number of occupied I/O points: Not required 4) Change in specifications Change in rated input voltage: Not required Change in rated input current: Not required 5) Change in functions : Not required

A/QnA series models to be discontinued		Q series alternative models	
Product	Model	Model	Remarks (restrictions)
Output module	AY23	QY23L	1) Change in external wiring: Not required (Existing terminal block can be utilized.) 2) Change in the number of slots: Not required 3) Change in a program Change in the number of occupied I/O points: Not required 4) Change in specifications Change in rated input voltage: Not required Change in rated input current: Not required Change in leakage current at OFF: Not required 5) Change in functions : Not required
	AY41	QY51PL	1) Change in external wiring: Not required (Existing terminal block can be utilized.) 2) Change in the number of slots: Not required 3) Change in a program Change in the number of occupied I/O points: Not required 4) Change in specifications Change in rated output voltage: Required (28.8VDC or more not applicable) Change in rated output current: Required (from 0.1A to 0.5A) 5) Change in functions : Required (Surge suppressor: Clamp diode → Zener diode, Protection function: Not supported → Supported)
	AY41P		1) Change in external wiring: Not required (Existing terminal block can be utilized.) 2) Change in the number of slots: Not required 3) Change in a program Change in the number of occupied I/O points: Not required 4) Change in specifications Change in rated output voltage: Not required Change in rated output current: Required (from 0.1A to 0.5A) 5) Change in functions : Required (Surge suppressor: Clamp diode → Zener diode, Protection function: Per 8 points → Per 1 point)
	AY51	QY51PL	1) Change in external wiring: Not required (Existing terminal block can be utilized.) 2) Change in the number of slots: Not required 3) Change in a program Change in the number of occupied I/O points: Not required 4) Change in specifications Change in rated output voltage: Required (28.8VDC or more not applicable) Change in rated output current: Required (from 0.1A to 0.5A) 5) Change in functions : Required (Surge suppressor: Varistor → Zener diode, Protection function: Not supported → Supported)
	AY51-S1		1) Change in external wiring: Not required (Existing terminal block can be utilized.) 2) Change in the number of slots: Not required 3) Change in a program Change in the number of occupied I/O points: Not required 4) Change in specifications Change in rated output voltage: Required (28.8VDC or more not applicable) Change in rated output current: Required (from 0.1A to 0.5A) 5) Change in functions : Required (Surge suppressor: Transistor built-in zener diode → Zener diode, Fuse blown indication: Supported → Not supported)

3.2 I/O Module Specifications Comparison

3.2.1 Input module specifications comparison

(1) Specifications comparison between AX10 and QX10

○: Compatible, △: Partial change required, ×: Incompatible

Specification	AX10	QX10	Compat- ibility	Precautions for replacement
Number of input points	16 points	16 points	○	
Insulation method	Photocoupler	Photocoupler	○	
Rated input voltage	100-120VAC 50/60Hz	100-120VAC 50/60Hz	○	
Input voltage distortion	within 5%	within 5%	○	
Rated input current	10mA (100VAC 60Hz)	Approx. 8mA (100VAC, 60Hz), Approx. 7mA (100VAC, 50Hz)	△	Reduced. *1
Inrush current	Max. 300mA within 0.3ms (132VAC)	Max. 200mA within 1ms (132VAC)	○	
Operating voltage range	85 to 132VAC (50/60Hz ± 5%)	85 to 132VAC (50/60Hz ± 3Hz)	○	
Maximum number of simultaneous input points	100% (16 points) Simultaneously ON	Refer to the derating chart. *2	△	Use within the range shown in the derating figure.
ON voltage/ON current	80VAC or more/6mA or more	80VAC or more/5mA or more (50Hz, 60Hz)	○	
OFF voltage/OFF current	40VAC or less/4mA or less	30VAC or less/1.7mA or less (50Hz, 60Hz)	△	Reduced. *1
Input resistance	Approx. 10kΩ (60Hz), Approx. 12kΩ (50Hz)	Approx. 12kΩ (60Hz), Approx. 15kΩ (50Hz)	△	Input resistance has increased. *1
Response time	OFF to ON	15ms or less (100VAC 50Hz, 60Hz)	○	
	ON to OFF	25ms or less	○	
Common terminal arrangement	16 points/common (Common terminal: TB9, TB18)	16 points/common (Common terminal: TB17)	○	
Operation indication	ON indication (LED)	ON indication (LED)	○	
External connection method	20-point terminal block connector (M3 × 6 screws)	18-point terminal block (M3 × 6 screws)	×	Wiring change is required. *3
Applicable wire size	0.75 to 2mm ²	0.3 to 0.75mm ² core (Outside diameter: 2.8mm or less.)	×	
Applicable solderless terminal	R1.25-3, R2-3, RAV1.25-3, RAV2-3	R1.25-3 (Sleeved solderless terminals cannot be used.)	×	
Current consumption	0.055A (TYP. all points ON)	0.05A (TYP. all points ON)	○	
External dimensions	250 (H) × 37.5 (W) × 121 (D) mm	98 (H) × 27.4 (W) × 90 (D) mm	△	Wiring space is narrow.
Weight	0.39kg	0.17kg	△	

*1 Check the specifications of the sensor or switches to be connected to the QX10.

*2 The following shows the derating chart.

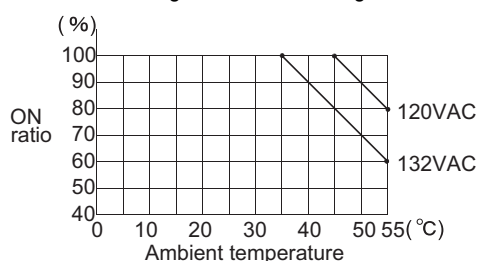

*3 The wiring change is not required by using the conversion adapter (ERNT-AQTX10) manufactured by Mitsubishi Electric Engineering Co., Ltd.

(2) Specifications comparison between AX10-UL and QX10

○: Compatible, △: Partial change required, ×: Incompatible

Specification		AX10-UL	QX10	Compat- ibility	Precautions for replacement
Number of input points		16 points	16 points	○	
Insulation method		Photocoupler	Photocoupler	○	
Rated input voltage		110-120VAC 50/60Hz	100-120VAC 50/60Hz	○	
Input voltage distortion		within 5%	within 5%	○	
Rated input current		11mA (110VAC) 12mA (120VAC)	Approx. 8mA (100VAC, 60Hz), Approx. 7mA (110VAC, 50Hz)	△	Reduced. *1
Inrush current		Max. 300mA within 0.3ms (132VAC)	Max. 200mA within 1ms (132VAC)	○	
Operating voltage range		85 to 132VAC (50/60Hz ± 5%)	85 to 132VAC (50/60Hz ± 3Hz)	○	
Maximum number of simultaneous input points		100% (16 points) Simultaneously ON	Refer to the derating chart. *2	○	
ON voltage/ON current		80VAC or more/6mA or more	80VAC or more/5mA or more (50Hz, 60Hz)	○	
OFF voltage/OFF current		40VAC or less/4mA or less	30VAC or less/1.7mA or less (50Hz, 60Hz)	△	Reduced. *1
Input impedance		Approx. 10kΩ (60Hz), Approx. 12kΩ (50Hz)	Approx. 12kΩ (60Hz), Approx. 15kΩ (50Hz)	△	Input resistance has increased. *1
Response time	OFF to ON	15ms or less	15ms or less (100VAC 50Hz, 60Hz)	○	
	ON to OFF	25ms or less	20ms or less (100VAC 50Hz, 60Hz)	○	
Common terminal arrangement		16 points/common (Common terminal: TB9, TB18)	16 points/common (Common terminal: TB17)	○	
Operation indication		ON indication (LED)	ON indication (LED)	○	
External connection method		20-point terminal block connector (M3.5 × 7 screws)	18-point terminal block (M3 × 6 screws)	×	Wiring change is required. *3
Applicable wire size		18 AWG to 14 AWG 0.75 to 2mm ²	0.3 to 0.75mm ² core (Outside diameter: 2.8mm or less)	×	
Applicable solderless terminal		RAV1.25-3.5, RAV2-3.5	R1.25-3 (Sleeved solderless terminals cannot be used.)	×	
Current consumption		0.055A (TYP. all points ON)	0.05A (TYP. all points ON)	○	
Dielectric withstand voltage		Between AC external terminals and ground, 1500VAC rms, 1 minute	1780VAC rms/3cycles (Altitude 2,000m)	○	
Insulation resistance		5MΩ or more by insulation resistance tester	10MΩ or more by insulation resistance tester	○	
Noise durability		By noise simulator of 1500Vp-p noise voltage, 1μs noise width and 25 to 60Hz noise frequency	By noise simulator of 1500Vp-p noise voltage, 1μs noise width and 25 to 60Hz noise frequency First transient noise IEC61000-4-4: 1kV	○	
External dimensions		250 (H) × 37.5 (W) × 121 (D) mm	98 (H) × 27.4 (W) × 90 (D) mm	△	Wiring space is narrow.
Weight		0.39kg	0.17kg	△	

*1 Check the specifications of the sensor or switches to be connected to the QX10.

*2 The following shows the derating chart.

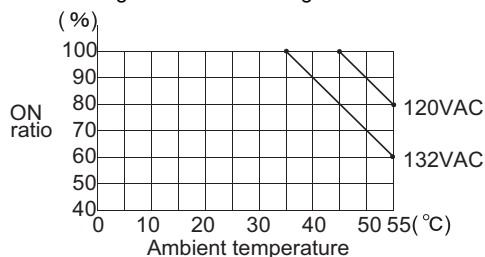

*3 The wiring change is not required by using the conversion adapter (ERNT-AQTX10) manufactured by Mitsubishi Electric Engineering Co., Ltd.

(3) Specifications comparison between AX11 and QX10

○: Compatible, △: Partial change required, ×: Incompatible

Specification		AX11	QX10	Compat- ibility	Precautions for replacement
Number of input points		32 points	16 points	△	Use two QX10s when using 17 points or more.
Insulation method		Photocoupler	Photocoupler	○	
Rated input voltage		100-120VAC 50/60Hz	100-120VAC 50/60Hz	○	
Input voltage distortion		within 5%	within 5%	○	
Rated input current		10mA (100VAC 60Hz)	Approx. 8mA (100VAC, 60Hz), Approx. 7mA (100VAC, 50Hz)	△	Reduced. *1
Inrush current		Max. 300mA within 0.3ms (132VAC)	Max. 200mA within 1ms (132VAC)	○	
Operating voltage range		85 to 132VAC (50/60Hz ± 5%)	85 to 132VAC (50/60Hz ± 3Hz)	○	
Maximum number of simultaneous input points		60% (20 points) Simultaneously ON	Refer to the derating chart. *2	○	
ON voltage/ON current		80VAC or more/6mA or more	80VAC or more/5mA or more (50Hz, 60Hz)	○	
OFF voltage/OFF current		40VAC or less/4mA or less	30VAC or less/1.7mA or less (50Hz, 60Hz)	△	Reduced. *1
Input resistance		Approx. 10kΩ (60Hz), Approx. 12kΩ (50Hz)	Approx. 12kΩ (60Hz), Approx. 15kΩ (50Hz)	△	Input resistance has increased. *1
Response time	OFF to ON	15ms or less	15ms or less (100VAC 50Hz, 60Hz)	○	
	ON to OFF	25ms or less	20ms or less (100VAC 50Hz, 60Hz)	○	
Common terminal arrangement		32 points/common (Common terminal: TB9, TB18, TB27, TB36)	16 points/common (Common terminal:TB17)	○	
Operation indication		ON indication (LED)	ON indication (LED)	○	
External connection method		38-point terminal block connector (M3 × 6 screws)	18-point terminal block (M3 × 6 screws)	×	Wiring change is required.
Applicable wire size		0.75 to 2mm ²	0.3 to 0.75mm ² core (Outside diameter: 2.8mm or less)	×	
Applicable solderless terminal		R1.25-3, R2-3, RAV1.25-3, RAV2-3	R1.25-3 (Sleeved solderless terminals cannot be used.)	×	
Current consumption		0.11A (TYP. all points ON)	0.05A (TYP. all points ON)	○	
External dimensions		250 (H) × 37.5 (W) × 131 (D)mm	98 (H) × 27.4 (W) × 90 (D) mm	△	Wiring space is narrow.
Weight		0.49kg	0.17kg	△	

*1 Check the specifications of the sensor or switches to connected to the QX10.

*2 The following shows the derating chart.

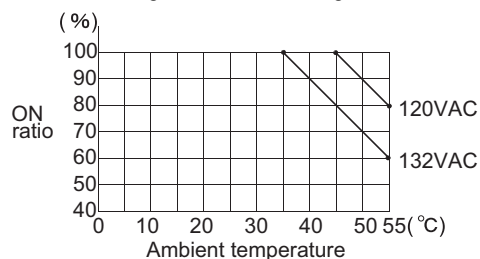

(4) Specifications comparison between AX11EU and QX10

○:Compatible, △: Partial change required, ×: Incompatible

Specification		AX11EU	QX10	Compat- ibility	Precautions for replacement
Number of input points		32 points	16 points	△	Use two QX10s when using 17 points or more.
Insulation method		Photocoupler	Photocoupler	○	
Rated input voltage		100-120VAC 50/60Hz	100-120VAC 50/60Hz	○	
Input voltage distortion		Within 5%	Within 5%	○	
Rated input current		12mA (120VAC 60Hz)	Approx. 8mA (100VAC, 60Hz), Approx. 7mA (100VAC, 50Hz)	△	Reduced. *1
Inrush current		Max. 300mA within 1ms (132VAC)	Max. 200mA within 1ms (132VAC)	○	
Operating voltage range		85 to 132 VAC (50/60Hz ± 5%)	85 to 132VAC (50/60Hz ± 3Hz)	○	
Maximum number of simultaneous input points		60% (20 points) Simultaneously ON	Refer to the derating chart.*2	○	
ON voltage/ON current		79VAC or more/6mA or more	80VAC or more/5mA or more (50Hz, 60Hz)	○	
OFF voltage/OFF current		40VAC or less/4mA or less	30VAC or less/1.7mA or less (50Hz, 60Hz)	△	Reduced. *1
input resistance		Approx. 10kΩ (60Hz), Approx. 12kΩ (50Hz)	Approx. 12kΩ (60Hz), Approx. 15kΩ (50Hz)	△	Input resistance has increased. *1
Response time	OFF to ON	15ms or less (100VAC 60Hz)	15ms or less (100VAC 50Hz, 60Hz)	○	
	ON to OFF	25ms or less (100VAC 60Hz)	20ms or less (100VAC 50Hz, 60Hz)	○	
Common terminal arrangement		32 points/common (Common terminal: TB9, TB18, TB27, TB36)	16 points/common (Common terminal:TB17)	○	
Operation indication		ON indication (LED)	ON indication (LED)	○	
External connection method		38-point terminal block connector (M3.5 × 6 screws)	18-point terminal block (M3 × 6 screws)	×	Wiring change is required.
Applicable wire size		0.75 to 2mm ² (AWG14 to AWG19)	0.3 to 0.75mm ² core (Outside diameter: 2.8mm or less)	×	
Applicable solderless terminal		RAV1.25-3.5,RAV2-3.5	R1.25-3 (Sleeved solderless terminals cannot be used.)	×	
Current consumption		0.15A (TYP. all points ON)	0.05A (TYP. all points ON)	○	
Dielectric withstand voltage (Across external circuit and internal circuit)		1780VAC rms/3cycles (Altitude 2,000m)	1780VAC rms/3cycles (Altitude 2,000m)	○	
Insulation resistance		10MΩ or more by insulation resistance tester	10MΩ or more by insulation resistance tester	○	
Noise durability		IEC801-4 : 1kV	By noise simulator of 1500Vp-p noise voltage, 1μs noise width and 25 to 60Hz noise frequency First transient noise IEC61000-4-4: 1kV	○	
External dimensions		250 (H) × 37.5 (W) × 131 (D) mm	98 (H) × 27.4 (W) × 90 (D) mm	△	Wiring space is narrow.
Weight		0.50kg	0.17kg	△	

*1 Check the specifications of the sensor or switches to be connected to the QX10.

*2 The following shows the derating chart.

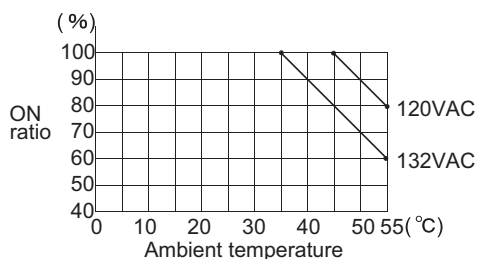

(5) Specifications comparison between AX20 and QX28

○: Compatible, △: Partial change required, ×: Incompatible

Specification		AX20	QX28	Compat- ibility	Precautions for replacement
Number of input points		16 points	8 points (16 points occupied)	△	Use two QX28s when using 9 points or more.
Insulation method		Photocoupler	Photocoupler	○	
Rated input voltage		200-240VAC 50/60Hz	100-240VAC 50/60Hz	○	
Input voltage distortion		Within 5%	Within 5%	○	
Rated input current		10mA (200VAC 60Hz)	Approx. 17mA (200VAC, 60Hz), Approx. 14mA (200VAC, 50Hz), Approx. 8mA (100VAC, 60Hz), Approx. 7mA (100VAC, 50Hz)	○	
Inrush current		Max. 600mA within 0.12ms (264VAC)	Max. 950mA within 1ms (264VAC)	○	
Operating voltage range		170 to 264VAC (50/60Hz ± 5%)	85 to 264VAC (50/60Hz ± 3Hz)	○	
Maximum number of simultaneous input points		100% (16 points) Simultaneously ON	Refer to the derating chart. *1	△	Use within the range shown in the derating figure.
ON voltage/ON current		160VAC or more/5.5mA or more	80VAC or more/5mA or more (50Hz, 60Hz)	○	
OFF voltage/OFF current		70VAC or less/3.5mA or less	30VAC or less/1.7mA or less (50Hz, 60Hz)	△	Reduced. *2
Input resistance		Approx. 22kΩ (60Hz), Approx. 24kΩ (50Hz)	Approx. 12kΩ (60Hz) , Approx. 15kΩ (50Hz)	○	
Response time	OFF to ON	15ms or less	10ms or less (100VAC 50Hz, 60Hz)	○	
	ON to OFF	25ms or less	20ms or less (100VAC 50Hz, 60Hz)	○	
Common terminal arrangement		16 points/common (Common terminal:TB9, TB18)	8 points/common (Common terminal:TB17)	○	
Operation indication		ON indication (LED)	ON indication (LED)	○	
External connection method		20-point terminal block connector (M3 × 6 screws)	18-point terminal block (M3 × 6 screws)	×	Wiring change is required.
Applicable wire size		0.75 to 2mm ²	0.3 to 0.75mm ² core (Outside diameter: 2.8mm or less)	×	
Applicable solderless terminal		R1.25-3, R2-3, RAV1.25-3, RAV2-3	R1.25-3 (Sleeved solderless terminals cannot be used.)	×	
Current consumption		0.055A (TYP. all points ON)	0.05A (TYP. all points ON)	△	Review current capacity when using two or more QX28s since current consumption is increased in that use.
External dimensions		250 (H) × 37.5 (W) × 121 (D) mm	98 (H) × 27.4 (W) × 90 (D) mm	△	Wiring space is narrow.
Weight		0.38kg	0.20kg	△	Calculate weight carefully when using 2 QX28s or more since the weight is increased in that use.

*1 The following shows the derating chart.

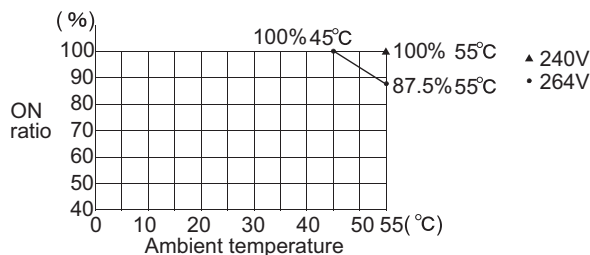

*2 Check the specifications of the sensor or switches to be connected to the QX28.

(6) Specifications comparison between AX20-UL and QX28

○: Compatible, △: Partial change required, ×: Incompatible

Specification		AX20-UL	QX28	Compat- ibility	Precautions for replacement
Number of input points		16 points	8 points (16 points occupied)	△	Use two QX28s when using 9 points or more.
Insulation method		Photocoupler	Photocoupler	○	
Rated input voltage		220-240VAC 50/60Hz	100-240VAC 50/60Hz	○	
Input voltage distortion		within 5%	within 5%	○	
Rated input current		11mA (220VAC) 12mA (240VAC)	Approx. 17mA (200VAC, 60Hz), Approx. 14mA (200VAC, 50Hz) Approx. 8mA (100VAC, 60Hz), Approx. 7mA (100VAC, 50Hz)	○	
Inrush current		Max. 600mA within 0.12ms (264VAC)	Max. 950mA within 1ms (264VAC)	○	
Operating voltage range		170 to 264VAC (50/60Hz ± 5%)	85 to 264VAC (50/60Hz ± 3Hz)	○	
Maximum number of simultaneous input points		100% (16 points) Simultaneously ON	Refer to the derating chart.*1	○	
ON voltage/ON current		160VAC or more/5.5mA or more	80VAC or more/5mA or more (50Hz, 60Hz)	△	Reduced.*2
OFF voltage/OFF current		70VAC or less/3.5mA or less	30VAC or less/1.7mA or less (50Hz, 60Hz)	△	Reduced.*2
Input resistance		Approx. 22kΩ (60Hz), Approx. 24kΩ (50Hz)	Approx. 12kΩ (60Hz), Approx. 15kΩ (50Hz)	○	
Response time	OFF to ON	15ms or less	10ms or less (100VAC 50Hz, 60Hz)	○	
	ON to OFF	25ms or less	20ms or less (100VAC 50Hz, 60Hz)	○	
Common terminal arrangement		16 points/common (Common terminal: TB9, TB18)	8 points/common (Common terminal: TB17)	○	
Operation indication		ON indication (LED)	ON indication (LED)	○	
External connection method		20-point terminal block connector (M3.5 × 7 screws)	18-point terminal block (M3 × 6 screws)	×	Wiring change is required.
Applicable wire size		18 AWG to 14 AWG 0.75 to 2mm ²	0.3 to 0.75mm ² core (Outside diameter: 2.8mm or less)	×	
Applicable solderless terminal		RAV1.25-3.5, RAV2-3.5	R1.25-3 (Sleeved solderless terminals cannot be used.)	×	
Current consumption		0.055A (TYP. all points ON)	0.05A (TYP. all points ON)	△	Review current capacity when using two or more QX28s since current consumption is increased in that use.
Dielectric withstand voltage (Across external circuit and internal circuit)		Between AC external terminals and ground, 1500VAC rms, 1 minute	2830VAC rms/3cycles (Altitude 2,000m)	○	
Insulation resistance		5MΩ or more by insulation resistance tester	10MΩ or more by insulation resistance tester	○	
Noise durability		By noise simulator of 1500Vp-p noise voltage, 1μs noise width and 25 to 60Hz noise frequency	By noise simulator of 1500Vp-p noise voltage, 1μs noise width and 25 to 60Hz noise frequency First transient noise IEC61000-4-4: 1kV	○	
External dimensions		250 (H) × 37.5 (W) × 121 (D) mm	98 (H) × 27.4 (W) × 90 (D) mm	△	Wiring space is narrow.
Weight		0.38kg	0.20kg	△	Calculate weight carefully when using two QX28s or more since the weight is increased in that use.

*1 The following shows the derating chart.

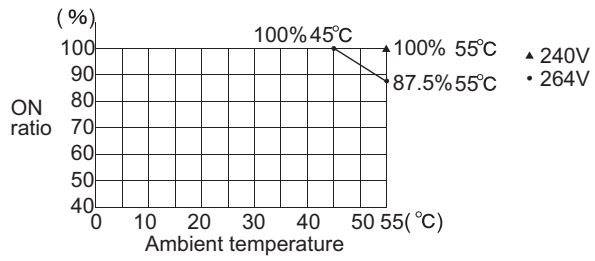

*2 Check the specifications of the sensor or switches to be connected to the QX28.

(7) Specifications comparison between AX21 and QX28

○: Compatible, △: Partial change required, ×: Incompatible

Specification	AX21	QX28	Compat- ibility	Precautions for replacement
Number of input points	32 points	8 points (16 points occupied)	△	Use the appropriate number of QX28s when using 9 points or more.
Insulation method	Photocoupler	Photocoupler	○	
Rated input voltage	200-240VAC 50/60Hz	100-240VAC 50/60Hz	○	
Input voltage distortion	within 5%	within 5%	○	
Rated input current	10mA (220VAC 60Hz)	Approx. 17mA (200VAC, 60Hz), Approx. 14mA (200VAC, 50Hz), Approx. 8mA (100VAC, 60Hz), Approx. 7mA (100VAC, 50Hz)	○	
Inrush current	Max. 600mA within 0.12ms (264VAC)	Max. 950mA within 1ms (264VAC)	○	
Operating voltage range	170 to 264VAC (50/60Hz ± 5%)	85 to 264VAC (50/60Hz ± 3Hz)	○	
Maximum number of simultaneous input points	60% (20 points) Simultaneously ON	Refer to the derating chart. *1	○	
ON voltage/ON current	160VAC or more/5.5mA or more	80VAC or more/5mA or more (50Hz, 60Hz)	○	
OFF voltage/OFF current	70VAC or less/3.5mA or less	30VAC or less/1.7mA or less (50Hz, 60Hz)	△	Reduced. *2
Input resistance	Approx. 22kΩ (60Hz), Approx. 24kΩ (50Hz)	Approx. 12kΩ (60Hz), Approx. 15kΩ (50Hz)	○	
Response time	OFF to ON	15ms or less	○	
	ON to OFF	25ms or less	○	
Common terminal arrangement	32 points/common (Common terminal: TB9, TB18, TB27, TB36)	8 points/common (Common terminal:TB17)	○	
Operation indication	ON indication (LED)	ON indication (LED)	○	
External connection method	38-point terminal block connector (M3 × 6 screws)	18-point terminal block (M3 × 6 screws)	×	Wiring change is required.
Applicable wire size	0.75 to 2mm ²	0.3 to 0.75mm ² core (Outside diameter: 2.8mm or less)	×	
Applicable solderless terminal	R1.25-3, R2-3, RAV1.25-3, RAV2-3	R1.25-3 (Sleeved solderless terminals cannot be used.)	×	
Current consumption	0.11A (TYP. all points ON)	0.05A (TYP. all points ON)	△	Review current capacity when using three or more QX28s since current consumption is increased in that use.
External dimensions	250 (H) × 37.5 (W) × 131 (D) mm	98 (H) × 27.4 (W) × 90 (D) mm	△	Wiring space is narrow.
Weight	0.50kg	0.20kg	△	Calculate weight carefully when using 3 QX28s or more since the weight is increased in that use.

*1 The following shows the derating chart.

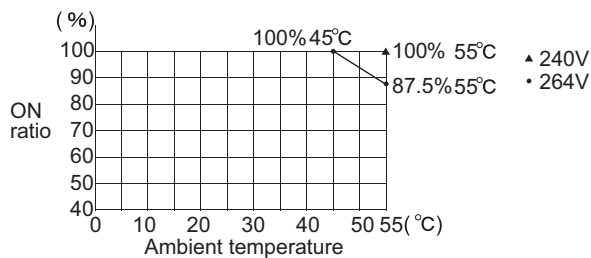

*2 Check the specifications of the sensor or switches to be connected to the QX28.

(8) Specifications comparison between AX21EU and QX28

○: Compatible, △: Partial change required, ×: Incompatible

Specification		AX21EU	QX28	Compat- ibility	Precautions for replacement
Number of input points		32 points	8 points (16 points occupied)	△	Use the appropriate number of QX28s when using 9 points or more.
Insulation method		Photocoupler	Photocoupler	○	
Rated input voltage		200-240VAC 50/60Hz	100-240VAC 50/60Hz	○	
Input voltage distortion		within 5%	within 5%	○	
Rated input current		Approx. 12mA (240VAC 60Hz)	Approx. 17mA (200VAC, 60Hz), Approx. 14mA (200VAC, 50Hz), Approx. 8mA (100VAC, 60Hz), Approx. 7mA (100VAC, 50Hz)	○	
Operating voltage range		170 to 264VAC (50/60Hz ± 5%)	85 to 264VAC (50/60Hz ± 3Hz)	○	
Maximum number of simultaneous input points		60% (20 points) Simultaneously ON	Refer to the derating chart. *1	○	
ON voltage/ON current		160VAC or more/5.5mA or more	80VAC or more/5mA or more (50Hz, 60Hz)	△	Increased.*2
OFF voltage/OFF current		70VAC or less/3.5mA or less	30VAC or less/1.7mA or less (50Hz, 60Hz)	△	Reduced.*2
Inrush current		Max. 600mA within 0.5ms (264VAC)	Max. 950mA within 1ms (264VAC)	○	
input impedance		Approx. 22kΩ (60Hz), Approx. 24kΩ (50Hz)	Approx. 12kΩ (60Hz), Approx. 15kΩ (50Hz)	○	
Response time	OFF to ON	15ms or less (200VAC 60Hz)	10ms or less (100VAC 50Hz, 60Hz)	○	
	ON to OFF	25ms or less (200VAC 60Hz)	20ms or less (100VAC 50Hz, 60Hz)	○	
Common terminal arrangement		32 points/common (Common terminal: TB9, TB18, TB27, TB36)	8 points/common (Common terminal:TB17)	○	
Operation indication		ON indication (LED)	ON indication (LED)	○	
External connection method		38-point terminal block connector (M3 × 6 screws)	18-point terminal block (M3 × 6 screws)	×	Wiring change is required.
Applicable wire size		0.75 to 2mm ² (AWG14 to AWG19)	0.3 to 0.75mm ² core (Outside diameter: 2.8mm or less)	×	
Applicable solderless terminal		RAV1.25-3.5, RAV2-3.5	R1.25-3 (Sleeved solderless terminals cannot be used.)	×	
Current consumption		0.15A (TYP. all points ON)	0.05A (TYP. all points ON)	△	Review current capacity when using three or more QX28s since current consumption is increased in that use.
Dielectric withstand voltage (Across external circuit and internal circuit)		2830VAC rms/3cycles (Altitude 2,000m)	2830VAC rms/3cycles (Altitude 2,000m)	○	
Insulation resistance		10MΩ or more by insulation resistance tester	10MΩ or more by insulation resistance tester	○	
Noise durability		IEC801-4 : 1kV	By noise simulator of 1500Vp-p noise voltage, 1μs noise width and 25 to 60Hz noise frequency First transient noise IEC61000-4-4: 1kV	○	
External dimensions		250 (H) × 37.5 (W) × 131 (D) mm	98 (H) × 27.4 (W) × 90 (D) mm	△	Wiring space is narrow.
Weight		0.50kg	0.20kg	△	Calculate weight carefully when using 3 QX28s or more since the weight is increased in that use.

*1 The following shows the derating chart.

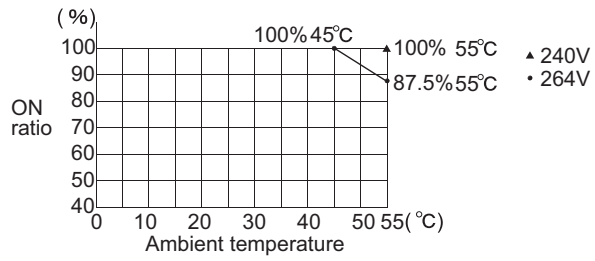

*2 Check the specifications of the sensor or switches to be connected to the QX28.

(9) Specifications comparison between AX31 (when using 24VDC and positive common) and QX41

○: Compatible, △: Partial change required, ×: Incompatible

Specification		AX31	QX41	Compat- ibility	Precautions for replacement
Number of input points		32 points	32 points	○	
Insulation method		Photocoupler	Photocoupler	○	
Rated input voltage		12/24VDC, 12/24VAC (50/60Hz)	24VDC	○	
Rated input current		8.5mA (24VDC/AC), 4mA (12VDC/AC)	Approx. 4mA	△	Reduced.*1
Operating voltage range		10.2 to 26.4VDC (Ripple ratio within 5%), 10.2 to 26.4VAC (50/60Hz ± 5%)	20.4 to 28.8VDC (Ripple ratio within 5%)	○	
Maximum number of simultaneous input points		100% Simultaneously ON	Refer to the derating chart.*2	△	Use within the range shown in the derating figure.
ON voltage/ON current		7VDC/AC or more/2mA or more	19VDC or more/3mA or more	△	The ON voltage/ON current are different.*1
OFF voltage/OFF current		2.5VDC/AC or less/0.7mA or less	11VDC or less/1.7mA or less	△	The OFF voltage/OFF current are different.*1
Input resistance		Approx. 2.7kΩ	Approx. 5.6kΩ	△	Input resistance has increased.*1
Response time	OFF to ON	20ms or less (12/24VDC) , 25ms or less (12/24VAC 60Hz)	1ms/5ms/10ms/20ms/70ms or less (CPU parameter setting) Initial setting is 10ms	○	Set the input response time of parameters to 20ms.
	ON to OFF	20ms or less (12/24VDC) , 20ms or less (12/24VAC 60Hz)	1ms/5ms/10ms/20ms/70ms or less (CPU parameter setting) Initial setting is 10ms	○	
Common terminal arrangement		32 points/common (Common terminal: TB9, TB18, TB27, TB36)	32 points/common (Common terminal:B01, B02)	○	
Operation indication		ON indication (LED)	ON indication (LED)	○	
External connection method		38-point terminal block connector (M3 × 6 screws)	40 pin connector (Option)	×	Wiring change is required.*3
Applicable wire size		0.75 to 2mm ²	0.3mm ² (For A6CON1 or A6CON4)	×	
Applicable solderless terminal		R1.25-3, R2-3, RAV1.25-3, RAV2-3	-	×	
Current consumption		0.11A (TYP. all points ON)	0.075A (TYP. all points ON)	○	
External dimensions		250 (H) × 37.5 (W) × 131 (D) mm	98 (H) × 27.4 (W) × 90 (D) mm	△	
Weight		0.49kg	0.15kg	△	

*1 Check the specifications of the sensor or switches to be connected to the QX41.

*2 The following shows the derating chart.

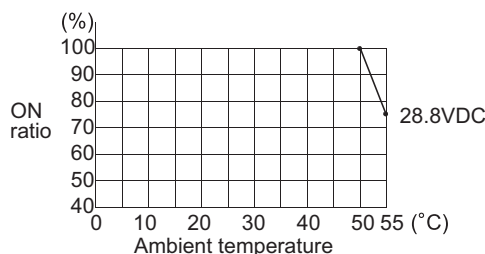

*3 By using connectors/terminal block converter modules such as the A6TBXY36 and the conversion module such as the FA-TB32XY, conversion to the terminal block is possible.

(10) Specifications comparison between AX31 (when using 24VDC and positive common) and QX41-S2

○: Compatible, △: Partial change required, ×: Incompatible

Specification		AX31	QX41-S2	Compat-ibility	Precautions for replacement
Number of input points		32 points	32 points	○	
Insulation method		Photocoupler	Photocoupler	○	
Rated input voltage		12/24VDC, 12/24VAC (50/60Hz)	24VDC	○	
Rated input current		8.5mA (24VDC/AC), 4mA (12VDC/AC)	Approx. 6mA	△	Reduced.*1
Operating voltage range		10.2 to 26.4VDC (Ripple ratio within 5%), 10.2 to 26.4VAC (50/60Hz ± 5%)	20.4 to 28.8VDC (Ripple ratio within 5%)	○	
Maximum number of simultaneous input points		100% Simultaneously ON	Refer to the derating chart.*2	△	Use within the range shown in the derating figure.
ON voltage/ON current		7VDC/AC or more/2mA or more	15VDC or more/3mA or more	△	The ON voltage/ON current are different.*1
OFF voltage/OFF current		2.5VDC/AC or less/0.7mA or less	5VDC or less/1.7mA or less	△	The OFF voltage/OFF current are different.*1
Input resistance		Approx. 2.7kΩ	Approx. 3.6kΩ	△	Input resistance has increased.*1
Response time	OFF to ON	20ms or less (12/24VDC), 25ms or less (12/24VAC 60Hz)	1ms/5ms/10ms/20ms/70ms or less (CPU parameter setting) Initial setting is 10ms	○	Set the input response time of parameters to 20ms.
	ON to OFF	20ms or less (12/24VDC), 20ms or less (12/24VAC 60Hz)	1ms/5ms/10ms/20ms/70ms or less (CPU parameter setting) Initial setting is 10ms	○	
Common terminal arrangement		32 points/common (Common terminal: TB9, TB18, TB27, TB36)	32 points/common (Common terminal: B01, B02)	○	
Operation indication		ON indication (LED)	ON indication (LED)	○	
External connection method		38-point terminal block connector (M3 × 6 screws)	40 pin connector (Option)	×	Wiring change is required.*3
Applicable wire size		0.75 to 2mm ²	0.3mm ² (For A6CON1 or A6CON4)	×	
Applicable solderless terminal		R1.25-3, R2-3, RAV1.25-3, RAV2-3	—	×	
Current consumption		0.11A (TYP. all points ON)	0.075A (TYP. all points ON)	○	
External dimensions		250 (H) × 37.5 (W) × 131 (D) mm	98 (H) × 27.4 (W) × 90 (D) mm	△	
Weight		0.49kg	0.15kg	△	

*1 Check the specifications of the sensor or switches to be connected to the QX41-S2.

*2 The following shows the derating chart.

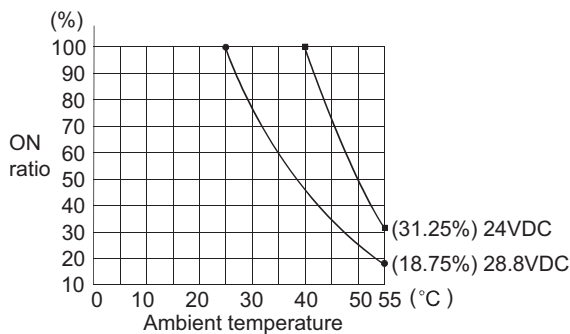

*3 By using connectors/terminal block converter modules such as the A6TBXY36 and the conversion module such as the FA-TB32XY, conversion to the terminal block is possible.

(11) Specifications comparison between AX31 (when using 24VDC and negative common) and QX81

○: Compatible, △: Partial change required, ×: Incompatible

Specification		AX31	QX81	Compat-ibility	Precautions for replacement
Number of input points		32 points	32 points	○	
Insulation method		Photocoupler	Photocoupler	○	
Rated input voltage		12/24VDC, 12/24VAC (50/60Hz)	24VDC	○	
Rated input current		8.5mA (24VDC/AC), 4mA (12VDC/AC)	Approx. 4mA	△	Reduced.*1
Operating voltage range		10.2 to 26.4VDC (Ripple ratio within 5%), 10.2 to 26.4VAC (50/60Hz ± 5%)	20.4 to 28.8VDC (Ripple ratio within 5%)	○	
Maximum number of simultaneous input points		100% Simultaneously ON	Refer to the derating chart.*2	△	Use within the range shown in the derating figure.
ON voltage/ON current		7VDC/AC or more/2mA or more	19VDC or more/3mA or more	△	The ON voltage/ON current are different.*1
OFF voltage/OFF current		2.5VDC/AC or less/0.7mA or less	11VDC or less/1.7mA or less	△	The OFF voltage/OFF current are different.*1
Input resistance		Approx. 2.7kΩ	Approx. 5.6kΩ	△	Input resistance has increased.*1
Response time	OFF to ON	20ms or less (12/24VDC) , 25ms or less (12/24VAC 60Hz)	1ms/5ms/10ms/20ms/70ms or less (CPU parameter setting) Initial setting is 10ms	○	Set the input response time of parameters to 20ms.
	ON to OFF	20ms or less (12/24VDC) , 20ms or less (12/24VAC 60Hz)	1ms/5ms/10ms/20ms/70ms or less (CPU parameter setting) Initial setting is 10ms	○	
Common terminal arrangement		32 points/common (Common terminal: TB9, TB18, TB27, TB36)	32 points/common (Common terminal: 17, 18, 36)	○	
Operation indication		ON indication (LED)	ON indication (LED)	○	
External connection method		38-point terminal block connector (M3 × 6 screws)	37 pin D-sub connector (Option)	×	Wiring change is required.*3
Applicable wire size		0.75 to 2mm ²	0.3mm ² (For A6CON1E)	×	
Applicable solderless terminal		R1.25-3, R2-3, RAV1.25-3, RAV2-3	-	×	
Current consumption		0.11A (TYP. all points ON)	0.075A (TYP. all points ON)	○	
External dimensions		250 (H) × 37.5 (W) × 131 (D) mm	98 (H) × 27.4 (W) × 90 (D) mm	△	
Weight		0.49kg	0.16kg	△	

*1 Check the specifications of the sensor or switches to be connected to the QX81.

*2 The following shows the derating chart.

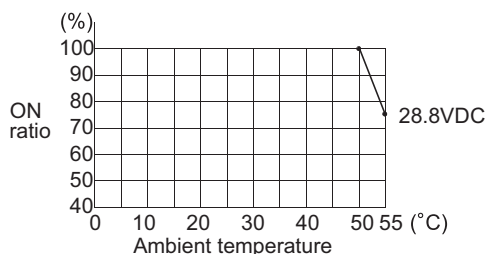

*3 By using connectors/terminal block converter modules such as the A6TBX36-E and the conversion module such as the FA-TB32XY, conversion to the terminal block is possible.

(12) Specifications comparison between AX31 (when using 24VDC and negative common) and QX81-S2

○: Compatible, △: Partial change required, ×: Incompatible

Specification		AX31	QX81-S2	Compat- ibility	Precautions for replacement
Number of input points		32 points	32 points	○	
Insulation method		Photocoupler	Photocoupler	○	
Rated input voltage		12/24VDC, 12/24VAC (50/60Hz)	24VDC	○	
Rated input current		8.5mA (24VDC/AC), 4mA (12VDC/AC)	Approx. 6mA	△	Reduced.*1
Operating voltage range		10.2 to 26.4VDC (Ripple ratio within 5%), 10.2 to 26.4VAC (50/60Hz ± 5%)	20.4 to 28.8VDC (Ripple ratio within 5%)	○	
Maximum number of simultaneous input points		100% Simultaneously ON	Refer to the derating chart.*2	△	Use within the range shown in the derating figure.
ON voltage/ON current		7VDC/AC or more/2mA or more	15VDC or more/3mA or more	△	The ON voltage/ON current are different.*1
OFF voltage/OFF current		2.5VDC/AC or less/0.7mA or less	5VDC or less/1.7mA or less	△	The OFF voltage/OFF current are different.*1
Input resistance		Approx. 2.7kΩ	Approx. 3.6kΩ	△	Input resistance has increased.*1
Response time	OFF to ON	20ms or less (12/24VDC) , 25ms or less (12/24VAC 60Hz)	1ms/5ms/10ms/20ms/70ms or less (CPU parameter setting) Initial setting is 10ms	○	Set the input response time of parameters to 20ms.
	ON to OFF	20ms or less (12/24VDC) , 20ms or less (12/24VAC 60Hz)	1ms/5ms/10ms/20ms/70ms or less (CPU parameter setting) Initial setting is 10ms	○	
Common terminal arrangement		32 points/common (Common terminal: TB9, TB18, TB27, TB36)	32 points/common (Common terminal: 17, 18, 36)	○	
Operation indication		ON indication (LED)	ON indication (LED)	○	
External connection method		38-point terminal block connector (M3 × 6 screws)	37 pin D-sub connector (Option)	×	Wiring change is required.*3
Applicable wire size		0.75 to 2mm ²	0.3mm ² (For A6CON1E)	×	
Applicable solderless terminal		R1.25-3, R2-3, RAV1.25-3, RAV2-3	—	×	
Current consumption		0.11A (TYP. all points ON)	0.075A (TYP. all points ON)	○	
External dimensions		250 (H) × 37.5 (W) × 131 (D) mm	98 (H) × 27.4 (W) × 90 (D) mm	△	
Weight		0.49kg	0.16kg	△	

*1 Check the specifications of the sensor or switches to be connected to the QX81-S2.

*2 The following shows the derating chart.

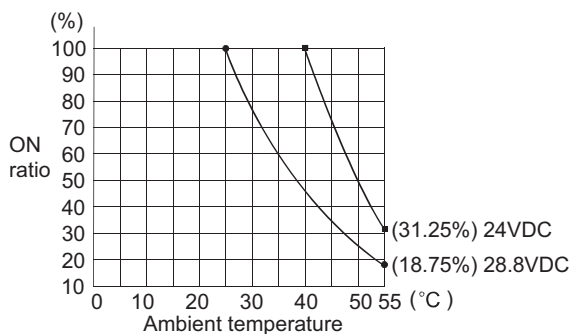

*3 By using connectors/terminal block converter modules such as the A6TBX36-E and the conversion module such as the FA-TB32XY, conversion to the terminal block is possible.

(13) Specifications comparison between AX31 (when using 12VDC) and QX71

○: Compatible, △: Partial change required, ×: Incompatible

Specification		AX31	QX71	Compat- ibility	Precautions for replacement
Number of input points		32 points	32 points	○	
Insulation method		Photocoupler	Photocoupler	○	
Rated input voltage		12/24VDC, 12/24VAC (50/60Hz)	5/12VDC	○	
Rated input current		8.5mA (24VDC/AC), 4mA (12VDC/AC)	5VDC, approx. 1.2mA 12VDC, approx. 3.3mA	△	Reduced*1
Operating voltage range		10.2 to 26.4VDC (Ripple ratio within 5%), 10.2 to 26.4VAC (50/60Hz ± 5%)	4.5 to 6VDC (Ripple ratio within 5%) 10.2 to 14.4VDC (Ripple ratio within 5%)	○	
Maximum number of simultaneous input points		100% Simultaneously ON	100% Simultaneously ON	○	
ON voltage/ON current		7VDC/AC or more/2mA or more	3.5VDC or more/1mA or more	△	The ON voltage/ON current are different.*1
OFF voltage/OFF current		2.5VDC/AC or less/0.7mA or less	1VDC or less/0.1mA or less	△	The OFF voltage/OFF current are different.*1
Input resistance		Approx. 2.7kΩ	Approx. 3.3kΩ	△	Input resistance has increased.*1
Response time	OFF to ON	20ms or less (12/24VDC) , 25ms or less (12/24VAC 60Hz)	1ms/5ms/10ms/20ms/70ms or less (CPU parameter setting) Initial setting is 10ms	○	Set the input response time of parameters to 20ms.
	ON to OFF	20ms or less (12/24VDC) , 20ms or less (12/24VAC 60Hz)	1ms/5ms/10ms/20ms/70ms or less (CPU parameter setting) Initial setting is 10ms	○	
Common terminal arrangement		32 points/common (Common terminal: TB9, TB18, TB27, TB36)	32 points/common (Common terminal: B01, B02)	○	
Operation indication		ON indication (LED)	ON indication (LED)	○	
External connection method		38-point terminal block connector (M3 × 6 screws)	40 pin connector (Option)	×	Wiring change is required.*2
Applicable wire size		0.75 to 2mm ²	0.3mm ² (For A6CON1 or A6CON4)	×	
Applicable solderless terminal		R1.25-3, R2-3, RAV1.25-3, RAV2-3	-	×	
Current consumption		0.11A (TYP. all points ON)	0.07A (TYP. all points ON)	○	
External dimensions		250 (H) × 37.5 (W) × 131 (D) mm	98 (H) × 27.4 (W) × 90 (D) mm	△	
Weight		0.49kg	0.12kg	△	

*1 Check the specifications of the sensor or switches to be connected to the QX71.

*2 By using connectors/terminal block converter modules such as the A6TBXY36 and the conversion module such as the FA-TB32XY, conversion to the terminal block is possible.

(14) Specifications comparison between AX31-S1 (when using positive common) and QX41

○: Compatible, △: Partial change required, ×: Incompatible

Specification		AX31-S1	QX41	Compat- ibility	Precautions for replacement
Number of input points		32 points	32 points	○	
Insulation method		Photocoupler	Photocoupler	○	
Rated input voltage		24VDC	24VDC	○	
Rated input current		8.5mA	Approx. 4mA	△	Reduced. *1
Operating voltage range		19.2 to 26.4VDC (Ripple ratio within 5%)	20.4 to 28.8VDC (Ripple ratio within 5%)	△	20.4VDC or more are required.
Maximum number of simultaneous input points		100% Simultaneously ON	Refer to the derating chart. *2	△	Use within the range shown in the derating figure.
ON voltage/ON current		16VDC or more/5mA or more	19VDC or more/3mA or more	△	The ON voltage/ON current are different. *1
OFF voltage/OFF current		8VDC or less/2mA or less	11VDC or less/1.7mA or less	△	The OFF voltage/OFF current are different. *1
Input resistance		Approx. 2.7kΩ	Approx. 5.6kΩ	△	Input resistance has increased. *1
Response time	OFF to ON	10ms or less	1ms/5ms/10ms/20ms/70ms or less (CPU parameter setting) Initial setting is 10ms	○	Use initial value (10ms) for the input response time of parameters.
	ON to OFF	10ms or less	1ms/5ms/10ms/20ms/70ms or less (CPU parameter setting) Initial setting is 10ms	○	
Common terminal arrangement		32 points/common (Common terminal: TB9, TB18, TB27, TB36)	32 points/common (Common terminal: B01, B02)	○	
Operation indication		ON indication (LED)	ON indication (LED)	○	
External connection method		38-point terminal block connector (M3 × 6 screws)	40 pin connector (Option)	×	Wiring change is required. *3
Applicable wire size		0.75 to 2mm ²	0.3mm ² (For A6CON1 or A6CON4)	×	
Applicable solderless terminal		R1.25-3, R2-3, RAV1.25-3, RAV2-3	—	×	
Current consumption		0.11A (TYP. all points ON)	0.075A (TYP. all points ON)	○	
External dimensions		250 (H) × 37.5 (W) × 131 (D) mm	98 (H) × 27.4 (W) × 90 (D) mm	△	
Weight		0.49kg	0.15kg	△	

*1 Check the specifications of the sensor or switches to be connected to the QX41.

*2 The following shows the derating chart.

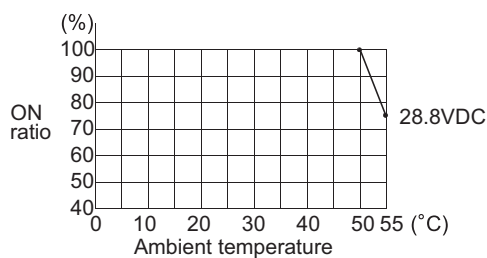

*3 By using connectors/terminal block converter modules such as the A6TBXY36 and the conversion module such as the FA-TB32XY, conversion to the terminal block is possible.

The wiring change is not required by using the conversion adapter (ERNT-AQTX41) manufactured by Mitsubishi Electric Engineering Co., Ltd.

(15) Specifications comparison between AX31-S1 (when using positive common) and QX41-S2

○: Compatible, △: Partial change required, ×: Incompatible

Specification		AX31-S1	QX41-S2	Compat- ibility	Precautions for replacement
Number of input points		32 points	32 points	○	
Insulation method		Photocoupler	Photocoupler	○	
Rated input voltage		24VDC	24VDC	○	
Rated input current		8.5mA	Approx. 6mA	△	Reduced. *1
Operating voltage range		19.2 to 26.4VDC (Ripple ratio within 5%)	20.4 to 28.8VDC (Ripple ratio within 5%)	△	20.4VDC or more are required.
Maximum number of simultaneous input points		100% Simultaneously ON	Refer to the derating chart. *2	△	Use within the range shown in the derating figure.
ON voltage/ON current		16VDC or more/5mA or more	15VDC or more/3mA or more	△	The ON voltage/ON current are different. *1
OFF voltage/OFF current		8VDC or less/2mA or less	5VDC or less/1.7mA or less	△	The OFF voltage/OFF current are different. *1
Input resistance		Approx. 2.7kΩ	Approx. 3.6kΩ	△	Input resistance has increased. *1
Response time	OFF to ON	10ms or less	1ms/5ms/10ms/20ms/70ms or less (CPU parameter setting) Initial setting is 10ms	○	Use initial value (10ms) for the input response time of parameters.
	ON to OFF	10ms or less	1ms/5ms/10ms/20ms/70ms or less (CPU parameter setting) Initial setting is 10ms	○	
Common terminal arrangement		32 points/common (Common terminal: TB9, TB18, TB27, TB36)	32 points/common (Common terminal: B01, B02)	○	
Operation indication		ON indication (LED)	ON indication (LED)	○	
External connection method		38-point terminal block connector (M3 × 6 screws)	40 pin connector (Option)	×	Wiring change is required. *3
Applicable wire size		0.75 to 2mm ²	0.3mm ² (For A6CON1 or A6CON4)	×	
Applicable solderless terminal		R1.25-3, R2-3, RAV1.25-3, RAV2-3	-	×	
Current consumption		0.11A (TYP. all points ON)	0.075A (TYP. all points ON)	○	
External dimensions		250 (H) × 37.5 (W) × 131 (D) mm	98 (H) × 27.4 (W) × 90 (D) mm	△	
Weight		0.49kg	0.15kg	△	

*1 Check the specifications of the sensor or switches to be connected to the QX41-S2.

*2 The following shows the derating chart.

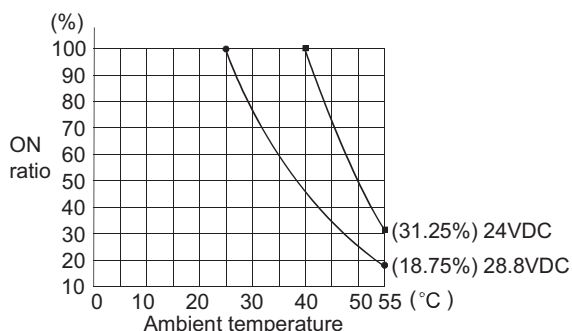

*3 By using connectors/terminal block converter modules such as the A6TBXY36 and the conversion module such as the FA-TB32XY, conversion to the terminal block is possible.

The wiring change is not required by using the conversion adapter (ERNT-AQTX41) manufactured by Mitsubishi Electric Engineering Co., Ltd.

(16) Specifications comparison between AX31-S1 (when using negative common) and QX81

○: Compatible, △: Partial change required, ×: Incompatible

Specification		AX31-S1	QX81	Compat- ibility	Precautions for replacement
Number of input points		32 points	32 points	○	
Insulation method		Photocoupler	Photocoupler	○	
Rated input voltage		24VDC	24VDC	○	
Rated input current		8.5mA	Approx. 4mA	△	Reduced. *1
Operating voltage range		19.2 to 26.4VDC (Ripple ratio within 5%)	20.4 to 28.8VDC (Ripple ratio within 5%)	△	20.4VDC or more are required.
Maximum number of simultaneous input points		100% Simultaneously ON	Refer to the derating chart. *2	△	Use within the range shown in the derating figure.
ON voltage/ON current		16VDC or more/5mA or more	19VDC or more/3mA or more	△	The ON voltage/ON current are different. *1
OFF voltage/OFF current		8VDC or less/2mA or less	11VDC or less/1.7mA or less	△	The OFF voltage/OFF current are different. *1
Input resistance		Approx. 2.7kΩ	Approx. 5.6kΩ	△	Input resistance has increased. *1
Response time	OFF to ON	10ms or less	1ms/5ms/10ms/20ms/70ms or less (CPU parameter setting) Initial setting is 10ms	○	Use initial value (10ms) for the input response time of parameters.
	ON to OFF	10ms or less	1ms/5ms/10ms/20ms/70ms or less (CPU parameter setting) Initial setting is 10ms	○	
Common terminal arrangement		32 points/common (Common terminal: TB9, TB18, TB27, TB36)	32 points/common (Common terminal: 17, 18, 36)	○	
Operation indication		ON indication (LED)	ON indication (LED)	○	
External connection method		38-point terminal block connector (M3 × 6 screws)	37 pin D-sub connector (Option)	×	Wiring change is required. *3
Applicable wire size		0.75 to 2mm ²	0.3mm ² (For A6CON1E)	×	
Applicable solderless terminal		R1.25-3, R2-3, RAV1.25-3, RAV2-3	-	×	
Current consumption		0.11A (TYP. all points ON)	0.075A (TYP. all points ON)	○	
External dimensions		250 (H) × 37.5 (W) × 131 (D) mm	98 (H) × 27.4 (W) × 90 (D) mm	△	
Weight		0.49kg	0.16kg	△	

*1 Check the specifications of the sensor or switches to be connected to the QX81.

*2 The following shows the derating chart.

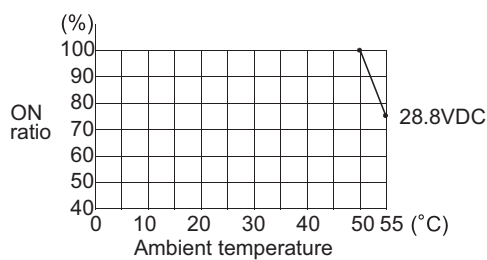

*3 By using connectors/terminal block converter modules such as the A6TBXY36 and the conversion module such as the FA-TB32XY, conversion to the terminal block is possible.

The wiring change is not required by using the conversion adapter (ERNT-AQTX41) manufactured by Mitsubishi Electric Engineering Co., Ltd.

(17) Specifications comparison between AX31-S1 (when using negative common) and QX81-S2

○: Compatible, △: Partial change required, ×: Incompatible

Specification		AX31-S1	QX81-S2	Compat- ibility	Precautions for replacement
Number of input points		32 points	32 points	○	
Insulation method		Photocoupler	Photocoupler	○	
Rated input voltage		24VDC	24VDC	○	
Rated input current		8.5mA	Approx. 6mA	△	Reduced. *1
Operating voltage range		19.2 to 26.4VDC (Ripple ratio within 5%)	20.4 to 28.8VDC (Ripple ratio within 5%)	△	20.4VDC or more are required.
Maximum number of simultaneous input points		100% Simultaneously ON	Refer to the derating chart. *2	△	Use within the range shown in the derating figure.
ON voltage/ON current		16VDC or more/5mA or more	15VDC or more/3mA or more	△	The ON voltage/ON current are different. *1
OFF voltage/OFF current		8VDC or less/2mA or less	5VDC or less/1.7mA or less	△	The OFF voltage/OFF current are different. *1
Input resistance		Approx. 2.7kΩ	Approx. 3.6kΩ	△	Input resistance has increased. *1
Response time	OFF to ON	10ms or less	1ms/5ms/10ms/20ms/70ms or less (CPU parameter setting) Initial setting is 10ms	○	Use initial value (10ms) for the input response time of parameters.
	ON to OFF	10ms or less	1ms/5ms/10ms/20ms/70ms or less (CPU parameter setting) Initial setting is 10ms	○	
Common terminal arrangement		32 points/common (Common terminal: TB9, TB18, TB27, TB36)	32 points/common (Common terminal: 17, 18, 36)	○	
Operation indication		ON indication (LED)	ON indication (LED)	○	
External connection method		38-point terminal block connector (M3 × 6 screws)	37 pin D-sub connector (Option)	×	Wiring change is required. *3
Applicable wire size		0.75 to 2mm ²	0.3mm ² (For A6CON1E)	×	
Applicable solderless terminal		R1.25-3, R2-3, RAV1.25-3, RAV2-3	-	×	
Current consumption		0.11A (TYP. all points ON)	0.075A (TYP. all points ON)	○	
External dimensions		250 (H) × 37.5 (W) × 131 (D) mm	98 (H) × 27.4 (W) × 90 (D) mm	△	
Weight		0.49kg	0.16kg	△	

*1 Check the specifications of the sensor or switches to be connected to the QX81-S2.

*2 The following shows the derating chart.

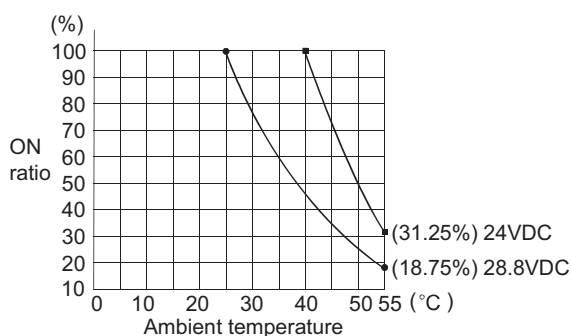

*3 By using connectors/terminal block converter modules such as the A6TBXY36 and the conversion module such as the FA-TB32XY, conversion to the terminal block is possible.

The wiring change is not required by using the conversion adapter (ERNT-AQTX41) manufactured by Mitsubishi Electric Engineering Co., Ltd.

(18) Specifications comparison between AX40 (when using 24VDC) and QX40

○:Compatible, △: Partial change required, ×: Incompatible

Specification		AX40	QX40	Compat- ibility	Precautions for replacement
Number of input points		16 points	16 points	○	
Insulation method		Photocoupler	Photocoupler	○	
Rated input voltage		12V/24VDC	24VDC	○	
Rated input current		Approx. 4mA/Approx. 10mA	Approx. 4mA	△	Reduced.*1
Operating voltage range		10.2 to 26.4VDC (Ripple ratio within 5%)	20.4 to 28.8VDC (Ripple ratio within 5%)	○	
Maximum number of simultaneous input points		100% (8 points/common) Simultaneously ON	100% Simultaneously ON	○	
ON voltage/ON current		9.5VDC or more/3mA or more	19VDC or more/3mA or more	△	The ON voltage is different.*1
OFF voltage/OFF current		6VDC or less/1.5mA or less	11VDC or less/1.7mA or less	△	The OFF voltage/OFF current are different.*1
Input resistance		Approx. 2.4kΩ	Approx. 5.6kΩ	△	Input resistance has increased.*1
Response time	OFF to ON	10ms or less	1ms/5ms/10ms/20ms/70ms or less (CPU parameter setting) Initial setting is 10ms	○	Use initial value (10ms) for the input response time of parameters.
	ON to OFF	10ms or less	1ms/5ms/10ms/20ms/70ms or less (CPU parameter setting) Initial setting is 10ms	○	
Common terminal arrangement		8 points/common (Common terminal:TB9, TB18)	16 points/common (Common terminal:TB17)	△	As the common changes from two commons to a common, wiring with a different voltage for each common is not possible.
Operation indication		ON indication (LED)	ON indication (LED)	○	
External connection method		20-point terminal block connector (M3 × 6 screws)	18-point terminal block (M3 × 6 screws)	×	Wiring change is required.*2
Applicable wire size		0.75 to 2mm ²	0.3 to 0.75mm ² core (Outside diameter: 2.8mm or less)	×	
Applicable solderless terminal		R1.25-3, R2-3, RAV1.25-3, RAV2-3	R1.25-3 (Sleeved solderless terminals cannot be used.)	×	
Current consumption		0.055A (TYP. all points ON)	0.05A (TYP. all points ON)	○	
External dimensions		250 (H) × 37.5 (W) × 121 (D) mm	98 (H) × 27.4 (W) × 90 (D) mm	△	Wiring space is narrow.
Weight		0.36kg	0.16kg	△	

*1 Check the specifications of the sensor or switches to be connected to the QX40.

*2 The wiring change is not required by using the conversion adapter (ERNT-AQTX40) manufactured by Mitsubishi Electric Engineering Co., Ltd.

(19) Specifications comparison between AX40 (when using 12VDC) and QX70

○:Compatible, △: Partial change required, ×: Incompatible

Specification		AX40	QX70	Compat- ibility	Precautions for replacement
Number of input points		16 points	16 points	○	
Insulation method		Photocoupler	Photocoupler	○	
Rated input voltage		12V/24VDC	5VDC/12VDC	○	
Rated input current		Approx. 4mA/Approx. 10mA	5VDC Approx. 1.2mA 12VDC Approx. 3.3mA	△	Reduced.*1
Operating voltage range		10.2 to 26.4VDC (Ripple ratio within 5%)	4.5 to 6VDC (Ripple ratio within 5%) 10.2 to 14.4VDC (Ripple ratio within 5%)	○	
Maximum number of simultaneous input points		100% (8 points/common) Simultaneously ON	100% Simultaneously ON	○	
ON voltage/ON current		9.5VDC or more/3mA or more	3.5VDC or more/1mA or more	△	The ON voltage/ON current are different.*1
OFF voltage/OFF current		6VDC or less/1.5mA or less	1VDC or less/0.1mA or less	△	The OFF voltage/OFF current are different.*1
Input resistance		Approx. 2.4kΩ	Approx. 3.3kΩ	△	Input resistance has increased.*1
Response time	OFF to ON	10ms or less	1ms/5ms/10ms/20ms/70ms or less (CPU parameter setting) Initial setting is 10ms	○	Use initial value (10ms) for the input response time of parameters.
	ON to OFF	10ms or less	1ms/5ms/10ms/20ms/70ms or less (CPU parameter setting) Initial setting is 10ms	○	
Common terminal arrangement		8 points/common (Common terminal:TB9, TB18)	16 points/common (Common terminal: TB17)	△	As the common changes from two commons to a common, wiring with a different voltage for each common is not possible.
Operation indication		ON indication (LED)	ON indication (LED)	○	
External connection method		20-point terminal block connector (M3 × 6 screws)	18-point terminal block (M3 × 6 screws)	×	Wiring change is required.*2
Applicable wire size		0.75 to 2mm ²	0.3 to 0.75mm ² core (Outside diameter: 2.8mm or less)	×	
Applicable solderless terminal		R1.25-3, R2-3, RAV1.25-3, RAV2-3	R1.25-3 (Sleeved solderless terminals cannot be used.)	×	
Current consumption		0.055A (TYP. all points ON)	0.055A (TYP. all points ON)	○	
External dimensions		250 (H) × 37.5 (W) × 121 (D) mm	98 (H) × 27.4 (W) × 90 (D) mm	△	Wiring space is narrow.
Weight		0.36kg	0.14kg	△	

*1 Check the specifications of the sensor or switches to be connected to the QX70.

*2 The wiring change is not required by using the conversion adapter (ERNT-AQTX40) manufactured by Mitsubishi Electric Engineering Co., Ltd.

(20) Specifications comparison between AX40-UL (when using 24VDC) and QX40

○: Compatible, △: Partial change required, ×: Incompatible

Specification		AX40-UL	QX40	Compat- ibility	Precautions for replacement
Number of input points		16 points	16 points	○	
Insulation method		Photocoupler	Photocoupler	○	
Rated input voltage		12V/24VDC	24VDC	○	
Rated input current		Approx. 4mA/Approx. 10mA	Approx. 4mA	△	Reduced.*1
Operating voltage range		10.2 to 26.4VDC (Ripple ratio within 5%)	20.4 to 28.8VDC (Ripple ratio within 5%)	○	
Maximum number of simultaneous input points		100% (8 points/common) Simultaneously ON	100% Simultaneously ON	○	
ON voltage/ON current		9.5VDC or more/3mA or more	19VDC or more/3mA or more	△	The ON voltage is different.*1
OFF voltage/OFF current		6VDC or less/1.5mA or less	11VDC or less/1.7mA or less	△	The OFF voltage/OFF current are different.*1
Input resistance		Approx. 2.4kΩ	Approx. 5.6kΩ	△	Input resistance has increased.*1
Response time	OFF to ON	10ms or less	1ms/5ms/10ms/20ms/70ms or less (CPU parameter setting) Initial setting is 10ms	○	Use initial value (10ms) for the input response time of parameters.
	ON to OFF	10ms or less	1ms/5ms/10ms/20ms/70ms or less (CPU parameter setting) Initial setting is 10ms	○	
Common terminal arrangement		8 points/common (Common terminal:TB9, TB18)	16 points/common (Common terminal:TB17)	△	As the common changes from two commons to a common, wiring with a different voltage for each common is not possible.
Operation indication		ON indication (LED)	ON indication (LED)	○	
External connection method		20-point terminal block connector (M3.5 × 7 screws)	18-point terminal block (M3 × 6 screws)	×	Wiring change is required.*3
Applicable wire size		18 AWG to 14 AWG (0.75 to 2mm ²)	0.3 to 0.75mm ² core (Outside diameter: 2.8mm or less)	×	
Applicable solderless terminal		RAV1.25-3.5, RAV2-3.5	R1.25-3 (Sleeved solderless terminals cannot be used.)	×	
Current consumption		0.055A (TYP. all points ON)	0.05A (TYP. all points ON)	○	
Dielectric withstand voltage (Across external circuit and internal circuit)		Between DC external terminals and ground, 500VAC rms, 1 minute	560VAC rms/3cycles (Altitude 2,000m)	○	
Insulation resistance		5MΩ or more by insulation resistance tester	10MΩ or more by insulation resistance tester	○	
Noise durability		By noise simulator of 500Vp-p noise voltage, 1μs noise width and 25 to 60Hz noise frequency	By noise simulator of 500Vp-p noise voltage, 1μs noise width and 25 to 60Hz noise frequency First transient noise IEC61000-4-4: 1kV	○	
External dimensions		250 (H) × 37.5 (W) × 121 (D) mm	98 (H) × 27.4 (W) × 90 (D) mm	△	Wiring space is narrow.
Weight		0.36kg	0.16kg	△	

*1 Check the specifications of the sensor or switches to be connected to the QX40.

(21) Specifications comparison between AX40-UL (when using 12VDC) and QX70

○: Compatible, △: Partial change required, ×: Incompatible

Specification		AX40-UL	QX70	Compat- ibility	Precautions for replacement
Number of input points		16 points	16 points	○	
Insulation method		Photocoupler	Photocoupler	○	
Rated input voltage		12V/24VDC	5VDC/12VDC	○	
Rated input current		Approx. 4mA/Approx. 10mA	5VDC Approx. 1.2mA 12VDC Approx. 3.3mA	△	Reduced.*1
Operating voltage range		10.2 to 26.4VDC (Ripple ratio within 5%)	4.5 to 6VDC (Ripple ratio within 5%) 10.2 to 14.4VDC (Ripple ratio within 5%)	○	
Maximum number of simultaneous input points		100% (8 points/common) Simultaneously ON	100% Simultaneously ON	○	
ON voltage/ON current		9.5VDC or more/3mA or more	3.5VDC or more/1mA or more	△	The ON voltage/ON current are different.*1
OFF voltage/OFF current		6VDC or less/1.5mA or less	1VDC or less/0.1mA or less	△	The OFF voltage/OFF current are different.*1
Input resistance		Approx. 2.4kΩ	Approx. 3.3kΩ	△	Input resistance has increased.*1
Response time	OFF to ON	10ms or less	1ms/5ms/10ms/20ms/70ms or less (CPU parameter setting) Initial setting is 10ms	○	Use initial value (10ms) for the input response time of parameters.
	ON to OFF	10ms or less	1ms/5ms/10ms/20ms/70ms or less (CPU parameter setting) Initial setting is 10ms	○	
Common terminal arrangement		8 points/common (Common terminal:TB9, TB18)	16 points/common (Common terminal: TB17)	△	As the common changes from two commons to a common, wiring with a different voltage for each common is not possible.
Operation indication		ON indication (LED)	ON indication (LED)	○	
External connection method		20-point terminal block connector (M3.5 × 7 screws)	18-point terminal block (M3 × 6 screws)	×	Wiring change is required.*2
Applicable wire size		18 AWG to 14 AWG (0.75 to 2mm ²)	0.3 to 0.75mm ² core (Outside diameter: 2.8mm or less)	×	
Applicable solderless terminal		RAV1.25-3.5, RAV2-3.5	R1.25-3 (Sleeved solderless terminals cannot be used.)	×	
Current consumption		0.055A (TYP. all points ON)	0.055A (TYP. all points ON)	○	
Dielectric withstand voltage (Across external circuit and internal circuit)		Between DC external terminals and ground, 500VAC rms, 1 minute	560VAC rms/3cycles (Altitude 2,000m)	○	
Insulation resistance		5MΩ or more by insulation resistance tester	10MΩ or more by insulation resistance tester	○	
Noise durability		By noise simulator of 500Vp-p noise voltage, 1μs noise width and 25 to 60Hz noise frequency	By noise simulator of 500Vp-p noise voltage, 1μs noise width and 25 to 60Hz noise frequency	○	
			First transient noise IEC61000-4-4: 1kV		
External dimensions		250 (H) × 37.5 (W) × 121 (D) mm	98 (H) × 27.4 (W) × 90 (D) mm	△	Wiring space is narrow.
Weight		0.36kg	0.14kg	△	

*1 Check the specifications of the sensor or switches to be connected to the QX70.

*2 The wiring change is not required by using the conversion adapter (ERNT-AQTX40) manufactured by Mitsubishi Electric Engineering Co., Ltd.

(22) Specifications comparison between AX41 (when using 24VDC) and QX41

○: Compatible, △: Partial change required, ×: Incompatible

Specification		AX41	QX41	Compat- ibility	Precautions for replacement
Number of input points		32 points	32 points	○	
Insulation method		Photocoupler	Photocoupler	○	
Rated input voltage		12V/24VDC	24VDC	△	
Rated input current		Approx. 4mA/Approx. 10mA	Approx. 4mA	△	Reduced.*1
Operating voltage range		10.2 to 26.4VDC (Ripple ratio within 5%)	20.4 to 28.8VDC (Ripple ratio within 5%)	△	
Maximum number of simultaneous input points		60% (5 point/common) Simultaneously ON	Refer to the derating chart.*2	○	
ON voltage/ON current		9.5VDC or more/3mA or more	19VDC or more/3mA or more	△	The ON voltage is different.*1
OFF voltage/OFF current		6VDC or less/1.5mA or less	11VDC or less/1.7mA or less	△	The OFF voltage/OFF current are different.*1
Input resistance		Approx. 2.4kΩ	Approx. 5.6kΩ	△	Input resistance has increased.*1
Response time	OFF to ON	10ms or less	1ms/5ms/10ms/20ms/70ms or less (CPU parameter setting) Initial setting is 10ms	○	Use initial value (10ms) for the input response time of parameters.
	ON to OFF	10ms or less	1ms/5ms/10ms/20ms/70ms or less (CPU parameter setting) Initial setting is 10ms	○	
Common terminal arrangement		8 points/common (Common terminal: TB9, TB18, TB27, TB36)	32 points/common (Common terminal: B01, B02)	△	For wiring, a different voltage cannot be applied to each common since the QX41 has only one common.
Operation indication		ON indication (LED)	ON indication (LED)	○	
External connection method		38-point terminal block connector (M3 × 6 screws)	40 pin connector (Option)	×	Wiring change is required.*3
Applicable wire size		0.75 to 2mm ²	0.3mm ² (For A6CON1 or A6CON4)	×	
Applicable solderless terminal		R1.25-3, R2-3, RAV1.25-3, RAV2-3	—	×	
Current consumption		0.11A (TYP. all points ON)	0.075A (TYP. all points ON)	○	
External dimensions		250 (H) × 37.5 (W) × 131 (D) mm	98 (H) × 27.4 (W) × 90 (D) mm	△	
Weight		0.44kg	0.15kg	△	

*1 Check the specifications of the sensor or switches to be connected to the QX41.

*2 The following shows the derating chart.

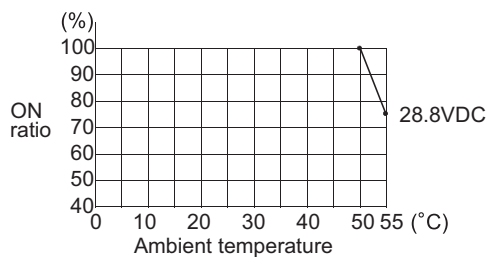

*3 The wiring change is not required by using the conversion adapter (ERNT-AQTX41) manufactured by Mitsubishi Electric Engineering Co., Ltd. By using connectors/terminal block converter modules such as the A6TBXY36 and the conversion module such as the FA-TB32XY, conversion to the terminal block is possible.

(23) Specifications comparison between AX41 (when using 24VDC) and QX41-S2

○: Compatible, △: Partial change required, ×: Incompatible

Specification		AX41	QX41-S2	Compat- ibility	Precautions for replacement
Number of input points		32 points	32 points	○	
Insulation method		Photocoupler	Photocoupler	○	
Rated input voltage		12V/24VDC	24VDC	○	
Rated input current		Approx. 4mA/Approx. 10mA	Approx. 6mA	△	Reduced.*1
Operating voltage range		10.2 to 26.4VDC (Ripple ratio within 5%)	20.4 to 28.8VDC (Ripple ratio within 5%)	○	
Maximum number of simultaneous input points		60% (5 point/common) Simultaneously ON	Refer to the derating chart.*2	○	
ON voltage/ON current		9.5VDC or more/3mA or more	15VDC or more/3mA or more	△	The ON voltage is different.*1
OFF voltage/OFF current		6VDC or less/1.5mA or less	5VDC or less/1.7mA or less	△	The OFF voltage/OFF current are different.*1
Input resistance		Approx. 2.4kΩ	Approx. 3.6kΩ	△	Input resistance has increased.*1
Response time	OFF to ON	10ms or less	1ms/5ms/10ms/20ms/70ms or less (CPU parameter setting) Initial setting is 10ms	○	Use initial value (10ms) for the input response time of parameters.
	ON to OFF	10ms or less	1ms/5ms/10ms/20ms/70ms or less (CPU parameter setting) Initial setting is 10ms	○	
Common terminal arrangement		8 points/common (Common terminal: TB9, TB18, TB27, TB36)	32 points/common (Common terminal: B01, B02)	△	As the common changes from four commons to a common, wiring with a different voltage for each common is not possible.
Operation indication		ON indication (LED)	ON indication (LED)	○	
External connection method		38-point terminal block connector (M3 × 6 screws)	40 pin connector (Option)	×	Wiring change is required.*3
Applicable wire size		0.75 to 2mm ²	0.3mm ² (For A6CON1 or A6CON4)	×	
Applicable solderless terminal		R1.25-3, R2-3, RAV1.25-3, RAV2-3	—	×	
Current consumption		0.11A (TYP. all points ON)	0.075A (TYP. all points ON)	○	
External dimensions		250 (H) × 37.5 (W) × 131 (D) mm	98 (H) × 27.4 (W) × 90 (D) mm	△	
Weight		0.44kg	0.15kg	△	

*1 Check the specifications of the sensor or switches to be connected to the QX41-S2.

*2 The following shows the derating chart.

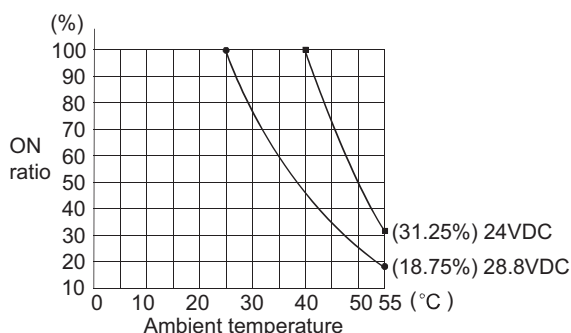

*3 The wiring change is not required by using the conversion adapter (ERNT-AQTX41) manufactured by Mitsubishi Electric Engineering Co., Ltd. By using connectors/terminal block converter modules such as the A6TBXY36 and the conversion module such as the FA-TB32XY, conversion to the terminal block is possible.

(24) Specifications comparison between AX41 (when using 12VDC) and QX71

○: Compatible, △: Partial change required, ×: Incompatible

Specification		AX41	QX71	Compat- ibility	Precautions for replacement
Number of input points		32 points	32 points	○	
Insulation method		Photocoupler	Photocoupler	○	
Rated input voltage		12V/24VDC	5VDC/12VDC	○	
Rated input current		Approx. 4mA/Approx. 10mA	5VDC Approx. 1.2mA 12VDC Approx. 3.3mA	△	Reduced.*1
Operating voltage range		10.2 to 26.4VDC (Ripple ratio within 5%)	4.5 to 6VDC (Ripple ratio within 5%) 10.2 to 14.4VDC (Ripple ratio within 5%)	○	
Maximum number of simultaneous input points		60% (5 point/common) Simultaneously ON	100% Simultaneously ON	○	
ON voltage/ON current		9.5VDC or more/3mA or more	3.5VDC or more/1mA or more	△	The ON voltage/ON current are different.*1
OFF voltage/OFF current		6VDC or less/1.5mA or less	1VDC or less/0.1mA or less	△	The OFF voltage/OFF current are different.*1
Input resistance		Approx. 2.4kΩ	Approx. 3.3kΩ	△	Input resistance has increased.*1
Response time	OFF to ON	10ms or less	1ms/5ms/10ms/20ms/70ms or less (CPU parameter setting) Initial setting is 10ms	○	Use initial value (10ms) for the input response time of parameters.
	ON to OFF	10ms or less	1ms/5ms/10ms/20ms/70ms or less (CPU parameter setting) Initial setting is 10ms	○	
Common terminal arrangement		8 points/common (Common terminal: TB9, TB18, TB27, TB36)	32 points/common (Common terminal: B01, B02)	△	As the common changes from four commons to a common, wiring with a different voltage for each common is not possible.
Operation indication		ON indication (LED)	ON indication (LED)	○	
External connection method		38-point terminal block connector (M3 × 6 screws)	40 pin connector (Option)	×	Wiring change is required.*2
Applicable wire size		0.75 to 2mm ²	0.3mm ² (22 AWG) (For A6CON1 or A6CON4)	×	
Applicable solderless terminal		R1.25-3, R2-3, RAV1.25-3, RAV2-3	—	×	
Current consumption		0.11A (TYP. all points ON)	0.07A (TYP. all points ON)	○	
External dimensions		250 (H) × 37.5 (W) × 131 (D) mm	98 (H) × 27.4 (W) × 90 (D) mm	△	
Weight		0.44kg	0.12kg	△	

*1 Check the specifications of the sensor or switches to be connected to the QX71.

*2 The wiring change is not required by using the conversion adapter (ERNT-AQTX41) manufactured by Mitsubishi Electric Engineering Co., Ltd. By using the conversion module such as the FA-TB32XY, conversion to the terminal block is possible.

(25) Specifications comparison between AX41-S1 (when using 24VDC) and QX41-S1

○: Compatible, △: Partial change required, ×: Incompatible

Specification		AX41-S1	QX41-S1	Compat- ibility	Precautions for replacement
Number of input points		32 points	32 points	○	
Insulation method		Photocoupler	Photocoupler	○	
Rated input voltage		12V/24VDC	24VDC	○	
Rated input current		Approx. 4mA/Approx. 10mA	Approx. 4mA	△	Reduced. *1
Operating voltage range		10.2 to 26.4VDC (Ripple ratio within 5%)	20.4 to 28.8VDC (Ripple ratio within 5%)	○	
Maximum number of simultaneous input points		60% (5 point/common) Simultaneously ON	Refer to the derating chart. *2	○	
ON voltage/ON current		9.5VDC or more/3mA or more	19VDC or more/3mA or more	△	The ON voltage is different. *1
OFF voltage/OFF current		6VDC or less/1.5mA or less	9.5VDC or less/1.5mA or less	△	The OFF voltage is different. *1
Input resistance		Approx. 2.4kΩ	Approx. 5.6kΩ	△	Input resistance has increased. *1
Response time	OFF to ON	0.1ms or less	0.1ms/0.2ms/0.4ms/0.6ms /1ms or less (CPU parameter setting) Initial setting is 0.2ms	○	Set the input response time of parameters to 0.1 ms.
	ON to OFF	0.2ms or less	0.1ms/0.2ms/0.4ms/0.6ms /1ms or less (CPU parameter setting) Initial setting is 0.2ms	○	
Common terminal arrangement		8 points/common (Common terminal: TB9, TB18, TB27, TB36)	32 points/common (Common terminal: B01, B02)	△	As the common changes from four commons to a common, wiring with a different voltage for each common is not possible.
Operation indication		ON indication (LED)	ON indication (LED)	○	
External connection method		38-point terminal block connector (M3 × 6 screws)	40 pin connector (Option)	×	Wiring change is required. *3
Applicable wire size		0.75 to 2mm ²	0.3mm ² (For A6CON1 or A6CON4)	×	
Applicable solderless terminal		R1.25-3, R2-3, RAV1.25-3, RAV2-3	—	×	
Current consumption		0.11A (TYP. all points ON)	0.075A (TYP. all points ON)	○	
External dimensions		250 (H) × 37.5 (W) × 131 (D) mm	98 (H) × 27.4 (W) × 90 (D) mm	△	
Weight		0.44kg	0.15kg	△	

*1 Check the specifications of the sensor or switches to be connected to the QX41-S1.

*2 The following shows the derating chart.

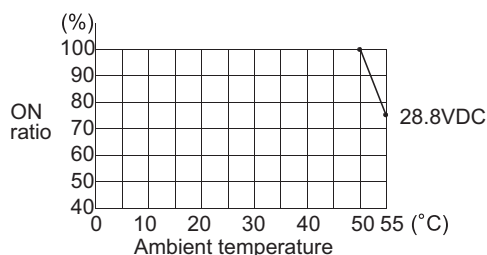

*3 The wiring change is not required by using the conversion adapter (ERNT-AQTX41) manufactured by Mitsubishi Electric Engineering Co., Ltd. By using connectors/terminal block converter modules such as the A6TBXY36 and the conversion module such as the FA-TB32XY, conversion to the terminal block is possible.

(26) Specifications comparison between AX41-S1 (when using 12VDC) and QX71

○: Compatible, △: Partial change required, ×: Incompatible

Specification		AX41-S1	QX71	Compat- ibility	Precautions for replacement
Number of input points		32 points	32 points	○	
Insulation method		Photocoupler	Photocoupler	○	
Rated input voltage		12V/24VDC	5V/12VDC	○	
Rated input current		Approx. 4mA/Approx. 10mA	5VDC Approx. 1.2mA 12VDC Approx. 3.3mA	△	Reduced.*1
Operating voltage range		10.2 to 26.4VDC (Ripple ratio within 5%)	4.5 to 6VDC (Ripple ratio within 5%) 10.2 to 14.4VDC (Ripple ratio within 5%)	○	
Maximum number of simultaneous input points		60% (5 point/common) Simultaneously ON	100% Simultaneously ON	○	
ON voltage/ON current		9.5VDC or more/3mA or more	3.5VDC or more/1mA or more	△	The ON voltage/ON current are different.*1
OFF voltage/OFF current		6VDC or less/1.5mA or less	1VDC or less/0.1mA or less	△	The OFF voltage/OFF current are different.*1
Input resistance		Approx. 2.4kΩ	Approx. 3.3kΩ	△	Input resistance has increased.*1
Response time	OFF to ON	0.1ms or less	1ms/5ms/10ms/20ms/70ms or less (CPU parameter setting) Initial setting is 10ms	△	Response time differs. Set the time depending on control targets.
	ON to OFF	0.2ms or less	1ms/5ms/10ms/20ms/70ms or less (CPU parameter setting) Initial setting is 10ms	△	
Common terminal arrangement		8 points/common (Common terminal: TB9, TB18, TB27, TB36)	32 points/common (Common terminal: B01, B02)	△	As the common changes from four commons to a common, wiring with a different voltage for each common is not possible.
Operation indication		ON indication (LED)	ON indication (LED)	○	
External connection method		38-point terminal block connector (M3 × 6 screws)	40 pin connector (Option)	×	Wiring change is required.*2
Applicable wire size		0.75 to 2mm ²	0.3mm ² (For A6CON1 or A6CON4)	×	
Applicable solderless terminal		R1.25-3, R2-3, RAV1.25-3, RAV2-3	—	×	
Current consumption		0.11A (TYP. all points ON)	0.075A (TYP. all points ON)	○	
External dimensions		250 (H) × 37.5 (W) × 131 (D) mm	98 (H) × 27.4 (W) × 90 (D) mm	△	
Weight		0.44kg	0.12kg	△	

*1 Check the specifications of the sensor or switches to be connected to the QX71.

*2 The wiring change is not required by using the conversion adapter (ERNT-AQTX41) manufactured by Mitsubishi Electric Engineering Co., Ltd. By using connectors/terminal block converter modules such as the A6TBXY36 and the conversion module such as the FA-TB32XY, conversion to the terminal block is possible.

(27) Specifications comparison between AX41-UL (when using 24VDC) and QX41

○: Compatible, △: Partial change required, ×: Incompatible

Specification		AX41-UL	QX41	Compat- ibility	Precautions for replacement
Number of input points		32 points	32 points	○	
Insulation method		Photocoupler	Photocoupler	○	
Rated input voltage		12VDC/24VDC	24VDC	○	
Rated input current		Approx. 4mA/ Approx. 10mA	Approx. 4mA	△	Reduced.*1
Operating voltage range		10.2 to 26.4VDC (Ripple ratio within 5%)	20.4 to 28.8VDC (Ripple ratio within 5%)	○	
Maximum number of simultaneous input points		60% (5 point/common) Simultaneously ON	Refer to the derating chart.*2	○	
ON voltage/ON current		9.5VDC or more/3mA or more	19VDC or more/3mA or more	△	The ON voltage is different.*1
OFF voltage/OFF current		6VDC or less/1.5mA or less	11VDC or less/1.7mA or less	△	The OFF voltage/OFF current are different.*1
Input resistance		Approx. 2.4kΩ	Approx. 5.6kΩ	△	Input resistance has increased.*1
Response time	OFF to ON	10ms or less	1ms/5ms/10ms/20ms/70ms or less (CPU parameter setting) Initial setting is 10ms	○	Use initial value (10ms) for the input response time of parameters.
	ON to OFF	10ms or less	1ms/5ms/10ms/20ms/70ms or less (CPU parameter setting) Initial setting is 10ms	○	
Common terminal arrangement		8 point/common (Common terminal: TB9, TB18, TB27, TB36)	32 points/common (Common terminal: B01, B02)	△	As the common changes from four commons to a common, wiring with a different voltage for each common is not possible.
Operation indication		ON indication (LED)	ON indication (LED)	○	
External connection method		38-point terminal block connector (M3.5 × 7 screws)	40 pin connector (Option)	×	Wiring change is required.*3
Applicable wire size		18 AWG to 14 AWG (0.75 to 2mm ²)	0.3mm ² (For A6CON1 or A6CON4)	×	
Applicable solderless terminal		RAV1.25-3.5, RAV2-3.5	-	×	
Current consumption		0.11A (TYP. all points ON)	0.075A (TYP. all points ON)	○	
Dielectric withstand voltage (Across external circuit and internal circuit)		Between DC external terminals and ground, 500VAC rms, 1 minute	560VAC rms/3cycles (Altitude 2,000m)	○	
Insulation resistance		5MΩ or more by insulation resistance tester	10MΩ or more by insulation resistance tester	○	
Noise durability		By noise simulator of 500Vp-p noise voltage, 1μs noise width and 25 to 60Hz noise frequency	By noise simulator of 500Vp-p noise voltage, 1μs noise width and 25 to 60Hz noise frequency First transient noise IEC61000-4-4: 1kV	○	
External dimensions		250 (H) × 37.5 (W) × 131 (D) mm	98 (H) × 27.4 (W) × 90 (D) mm	△	
Weight		0.44kg	0.15kg	△	

*1 Check the specifications of the sensor or switches to be connected to the QX41.

*2 The following shows the derating chart.

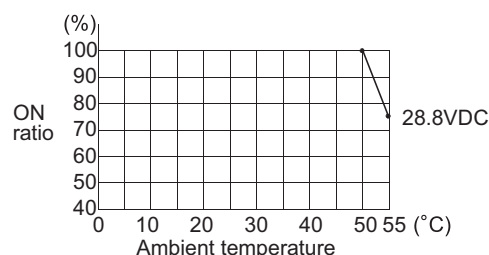

*3 The wiring change is not required by using the conversion adapter (ERNT-AQTX41) manufactured by Mitsubishi Electric Engineering Co., Ltd. By using connectors/terminal block converter modules such as the A6TBXY36 and the conversion module such as the FA-TB32XY, conversion to the terminal block is possible.

(28) Specifications comparison between AX41-UL (when using 24VDC) and QX41-S2

○: Compatible, △: Partial change required, ×: Incompatible

Specification		AX41-UL	QX41-S2	Compat- ibility	Precautions for replacement
Number of input points		32 points	32 points	○	
Insulation method		Photocoupler	Photocoupler	○	
Rated input voltage		12VDC/24VDC	24VDC	○	
Rated input current		Approx. 4mA/ Approx. 10mA	Approx. 6mA	△	Reduced.* ¹
Operating voltage range		10.2 to 26.4VDC (Ripple ratio within 5%)	20.4 to 28.8VDC (Ripple ratio within 5%)	○	
Maximum number of simultaneous input points		60% (5 point/common) Simultaneously ON	Refer to the derating chart.* ²	○	
ON voltage/ON current		9.5VDC or more/3mA or more	15VDC or more/3mA or more	△	The ON voltage is different.* ¹
OFF voltage/OFF current		6VDC or less/1.5mA or less	5VDC or less/1.7mA or less	△	The OFF voltage/OFF current are different.* ¹
Input resistance		Approx. 2.4kΩ	Approx. 3.6kΩ	△	Input resistance has increased.* ¹
Response time	OFF to ON	10ms or less	1ms/5ms/10ms/20ms/70ms or less (CPU parameter setting) Initial setting is 10ms	○	Use initial value (10ms) for the input response time of parameters.
	ON to OFF	10ms or less	1ms/5ms/10ms/20ms/70ms or less (CPU parameter setting) Initial setting is 10ms	○	
Common terminal arrangement		8 point/common (Common terminal: TB9, TB18, TB27, TB36)	32 points/common (Common terminal: B01, B02)	△	As the common changes from four commons to a common, wiring with a different voltage for each common is not possible.
Operation indication		ON indication (LED)	ON indication (LED)	○	
External connection method		38-point terminal block connector (M3.5 × 7 screws)	40 pin connector (Option)	×	Wiring change is required.* ³
Applicable wire size		18 AWG to 14 AWG (0.75 to 2mm ²)	0.3mm ² (22 AWG) (For A6CON1 or A6CON4)	×	
Applicable solderless terminal		RAV1.25-3.5, RAV2-3.5	–	×	
Current consumption		0.11A (TYP. all points ON)	0.075A (TYP. all points ON)	○	
Dielectric withstand voltage (Across external circuit and internal circuit)		Between DC external terminals and ground, 500VAC rms, 1 minute	560VAC rms/3cycles (Altitude 2,000m)	○	
Insulation resistance		5MΩ or more by insulation resistance tester	10MΩ or more by insulation resistance tester	○	
Noise durability		By noise simulator of 500Vp-p noise voltage, 1μs noise width and 25 to 60Hz noise frequency	By noise simulator of 500Vp-p noise voltage, 1μs noise width and 25 to 60Hz noise frequency First transient noise IEC61000-4-4: 1kV	○	
External dimensions		250 (H) × 37.5 (W) × 131 (D) mm	98 (H) × 27.4 (W) × 90 (D) mm	△	
Weight		0.44kg	0.15kg	△	

- *1 Check the specifications of the sensor or switches to be connected to the QX41-S2.
- *2 The following shows the derating chart.

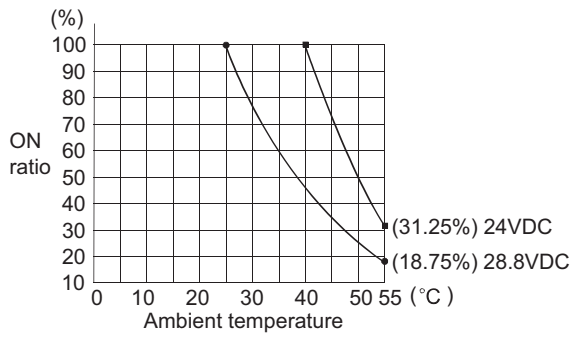

- *3 The wiring change is not required by using the conversion adapter (ERNT-AQTX41) manufactured by Mitsubishi Electric Engineering Co., Ltd. By using connectors/terminal block converter modules such as the A6TBXY36 and the conversion module such as the FA-TB32XY, conversion to the terminal block is possible.

(29) Specifications comparison between AX41-UL (when using 12VDC) and QX71

○: Compatible, △: Partial change required, ×: Incompatible

Specification		AX41-UL	QX71	Compat- ibility	Precautions for replacement
Number of input points		32 points	32 points	○	
Insulation method		Photocoupler	Photocoupler	○	
Rated input voltage		12VDC/24VDC	5VDC/12VDC	○	
Rated input current		Approx. 4mA/ Approx. 10mA	5VDC Approx. 1.2mA 12VDC Approx. 3.3mA	△	Reduced.*1
Operating voltage range		10.2 to 26.4VDC (Ripple ratio within 5%)	4.5 to 6VDC (Ripple ratio within 5%) 10.2 to 14.4VDC (Ripple ratio within 5%)	○	
Maximum number of simultaneous input points		60% (5 point/common) Simultaneously ON	100% Simultaneously ON	○	
ON voltage/ON current		9.5VDC or more/3mA or more	3.5VDC or more/1mA or more	△	The ON voltage/ON current are different.*1
OFF voltage/OFF current		6VDC or less/1.5mA or less	1VDC or less/0.1mA or less	△	The OFF voltage/OFF current are different.*1
Input resistance		Approx. 2.4kΩ	Approx. 3.3kΩ	△	Input resistance has increased.*1
Response time	OFF to ON	10ms or less	1ms/5ms/10ms/20ms/70ms or less (CPU parameter setting) Initial setting is 10ms	○	Use initial value (10ms) for the input response time of parameters.
	ON to OFF	10ms or less	1ms/5ms/10ms/20ms/70ms or less (CPU parameter setting) Initial setting is 10ms	○	
Common terminal arrangement		8 point/common (Common terminal: TB9, TB18, TB27, TB36)	32 points/common (Common terminal: B01, B02)	△	As the common changes from four commons to a common, wiring with a different voltage for each common is not possible.
Operation indication		ON indication (LED)	ON indication (LED)	○	
External connection method		38-point terminal block connector (M3.5 × 7 screws)	40 pin connector (Option)	×	Wiring change is required.*2
Applicable wire size		18 AWG to 14 AWG (0.75 to 2mm ²)	0.3mm ² (For A6CON1 or A6CON4)	×	
Applicable solderless terminal		RAV1.25-3.5, RAV2-3.5	—	×	
Current consumption		0.11A (TYP. all points ON)	0.07A (TYP. all points ON)	○	
Dielectric withstand voltage (Across external circuit and internal circuit)		Between DC external terminals and ground, 500VAC rms, 1 minute	560VAC rms/3cycles (Altitude 2,000m)	○	
Insulation resistance		5MΩ or more by insulation resistance tester	10MΩ or more by insulation resistance tester	○	
Noise durability		By noise simulator of 500Vp-p noise voltage, 1μs noise width and 25 to 60Hz noise frequency	By noise simulator of 500Vp-p noise voltage, 1μs noise width and 25 to 60Hz noise frequency	○	
			First transient noise IEC61000-4-4: 1kV		
External dimensions		250 (H) × 37.5 (W) × 131 (D) mm	98 (H) × 27.4 (W) × 90 (D) mm	△	
Weight		0.44kg	0.12kg	△	

*1 Check the specifications of the sensor or switches to be connected to the QX71.

*2 The wiring change is not required by using the conversion adapter (ERNT-AQTX41) manufactured by Mitsubishi Electric Engineering Co., Ltd. By using the conversion module such as the FA-TB32XY, conversion to the terminal block is possible.

(30) Specifications comparison between AX42 (when using 24VDC) and QX42

○: Compatible, △: Partial change required, ×: Incompatible

Specification		AX42	QX42	Compat- ibility	Precautions for replacement
Number of input points		64 points	64 points	○	
Insulation method		Photocoupler	Photocoupler	○	
Rated input voltage		12VDC/24VDC	24VDC	○	
Rated input current		Approx. 3mA/Approx. 7mA	Approx. 4mA	△	Reduced.*1
Operating voltage range		10.2 to 26.4VDC (Ripple ratio within 5%)	20.4 to 28.8VDC (Ripple ratio within 5%)	○	
Maximum number of simultaneous input points		60% (20point/common) Simultaneously ON	Refer to the derating chart.*2	△	Use within the range shown in the derating figure.
ON voltage/ON current		9.5VDC or more/3mA or more	19VDC or more/3mA or more	△	The ON voltage is different.*1
OFF voltage/OFF current		6VDC or less/1.5mA or less	11VDC or less/1.7mA or less	△	The OFF voltage/OFF current are different.*1
Input resistance		Approx. 3.4kΩ	Approx. 5.6kΩ	△	Input resistance has increased.*1
Response time	OFF to ON	10ms or less	1ms/5ms/10ms/20ms/70ms or less (CPU parameter setting) Initial setting is 10ms	○	Use initial value (10ms) for the input response time of parameters.
	ON to OFF	10ms or less	1ms/5ms/10ms/20ms/70ms or less (CPU parameter setting) Initial setting is 10ms	○	
Common terminal arrangement		32 points/common (Common terminal: 1B1, 1B2, 2B1, 2B2)	32 points/common (Common terminal: 1B01, 1B02, 2B01, 2B02)	○	
Operation indication		ON indication (LED) 32 point switch-over using switch	ON indication (LED) 32 point switch-over using switch	○	
External connection method		40pin connector (With solder) × 2	40 pin connector × 2 (Option)	○	The existing external wiring can be used without change.
Applicable wire size		0.3mm ²	0.3mm ² (For A6CON1 or A6CON4)	○	
Current consumption		0.12A (TYP. all points ON)	0.09A (TYP. all points ON)	○	
External dimensions		250 (H) × 37.5 (W) × 106 (D) mm	98 (H) × 27.4 (W) × 90 (D) mm	△	
Weight		0.51kg	0.18kg	△	

*1 Check the specifications of the sensor or switches to be connected to the QX42.

*2 The following shows the derating chart.

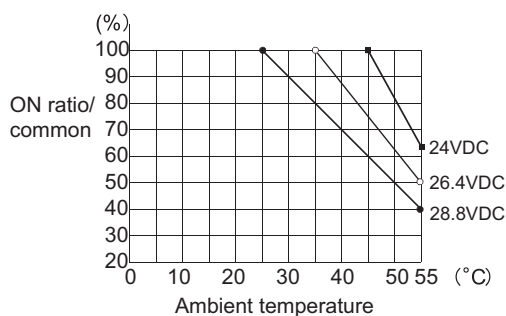

(31) Specifications comparison between AX42 (when using 24VDC) and QX41-S2

○: Compatible, △: Partial change required, ×: Incompatible

Specification		AX42	QX41-S2	Compat- ibility	Precautions for replacement
Number of input points		64 points	32 points	△	Use two QX41-S2s when using 33 points or more.
Insulation method		Photocoupler	Photocoupler	○	
Rated input voltage		12VDC/24VDC	24VDC	○	
Rated input current		Approx. 3mA/Approx. 7mA	Approx. 6mA	△	Reduced.*1
Operating voltage range		10.2 to 26.4VDC (Ripple ratio within 5%)	20.4 to 28.8VDC (Ripple ratio within 5%)	○	
Maximum number of simultaneous input points		60% (20point/common) Simultaneously ON	Refer to the derating chart.*2	△	Use within the range shown in the derating figure.
ON voltage/ON current		9.5VDC or more/3mA or more	15VDC or more/3mA or more	△	The ON voltage is different.*1
OFF voltage/OFF current		6VDC or less/1.5mA or less	5VDC or less/1.7mA or less	△	The OFF voltage/OFF current are different.*1
Input resistance		Approx. 3.4kΩ	Approx. 3.6kΩ	△	Input resistance has increased.*1
Response time	OFF to ON	10ms or less	1ms/5ms/10ms/20ms/70ms or less (CPU parameter setting) Initial setting is 10ms	○	Use initial value (10ms) for the input response time of parameters.
	ON to OFF	10ms or less	1ms/5ms/10ms/20ms/70ms or less (CPU parameter setting) Initial setting is 10ms	○	
Common terminal arrangement		32 points/common (Common terminal: 1B1, 1B2, 2B1, 2B2)	32 points/common (Common terminal: B01, B02)	○	
Operation indication		ON indication (LED) 32 point switch-over using switch	ON indication (LED)	○	
External connection method		40pin connector (With solder) × 2	40 pin connector (Option)	○	The existing external wiring can be used without change.
Applicable wire size		0.3mm ²	0.3mm ² (22 AWG) (For A6CON1 or A6CON4)	○	
Current consumption		0.12A (TYP. all points ON)	0.075A (TYP. all points ON)	○	
External dimensions		250 (H) × 37.5 (W) × 106 (D) mm	98 (H) × 27.4 (W) × 90 (D) mm	△	
Weight		0.51kg	0.15kg	△	

*1 Check the specifications of the sensor or switches to be connected to the QX41-S2.

*2 The following shows the derating chart.

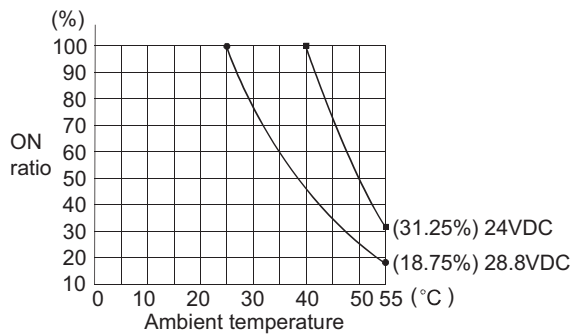

(32) Specifications comparison between AX42 (when using 12VDC) and QX72

○: Compatible, △: Partial change required, ×: Incompatible

Specification		AX42	QX72	Compat- ibility	Precautions for replacement
Number of input points		64 points	64 points	○	
Insulation method		Photocoupler	Photocoupler	○	
Rated input voltage		12VDC/24VDC	5VDC/12VDC	○	
Rated input current		Approx. 3mA/Approx. 7mA	5VDC Approx. 1.2mA 12VDC Approx. 3.3mA	○	
Operating voltage range		10.2 to 26.4VDC (Ripple ratio within 5%)	4.5 to 6VDC (Ripple ratio within 5%) 10.2 to 14.4VDC (Ripple ratio within 5%)	○	
Maximum number of simultaneous input points		60% (20point/common) Simultaneously ON	100% Simultaneously ON	○	
ON voltage/ON current		9.5VDC or more/3mA or more	3.5VDC or more/1mA or more	△	The ON voltage/ON current are different.*1
OFF voltage/OFF current		6VDC or less/1.5mA or less	1VDC or less/0.1mA or less	△	The OFF voltage/OFF current are different.*1
Input resistance		Approx. 3.4kΩ	Approx. 3.3kΩ	△	Input resistance has reduced.*1
Response time	OFF to ON	10ms or less	1ms/5ms/10ms/20ms/70ms or less (CPU parameter setting) Initial setting is 10ms	○	Use initial value (10ms) for the input response time of parameters.
	ON to OFF	10ms or less	1ms/5ms/10ms/20ms/70ms or less (CPU parameter setting) Initial setting is 10ms	○	
Common terminal arrangement		32 points/common (Common terminal: 1B1, 1B2, 2B1, 2B2)	32 points/common (Common terminal: 1B01, 1B02, 2B01, 2B02)	○	
Operation indication		ON indication (LED) 32 point switch-over using switch	ON indication (LED) 32 point switch-over using switch	○	
External connection method		40pin connector (With solder) × 2	40 pin connector (Option)	○	The existing external wiring can be used without change.
Applicable wire size		0.3mm ²	0.3mm ² (For A6CON1 or A6CON4)	○	
Current consumption		0.12A (TYP. all points ON)	0.085A (TYP. all points ON)	○	
External dimensions		250 (H) × 37.5 (W) × 106 (D) mm	98 (H) × 27.4 (W) × 90 (D) mm	△	
Weight		0.51kg	0.13kg	△	

*1 Check the specifications of the sensor or switches to be connected to the QX72.

(33) Specifications comparison between AX42-S1 (when using 24VDC) and QX42-S1

○: Compatible, △: Partial change required, ×: Incompatible

Specification		AX42-S1	QX42-S1	Compat- ibility	Precautions for replacement
Number of input points		64 points	64 points	○	
Insulation method		Photocoupler	Photocoupler	○	
Rated input voltage		12VDC/24VDC	24VDC	○	
Rated input current		Approx. 3mA/Approx. 7mA	Approx. 4mA	△	Reduced.*1
Operating voltage range		10.2 to 26.4VDC (Ripple ratio within 5%)	20.4 to 28.8VDC (Ripple ratio within 5%)	○	
Maximum number of simultaneous input points		60% (20 point/common) Simultaneously ON	Refer to the derating chart. *2	△	Use within the range shown in the derating figure.
ON voltage/ON current		9.5VDC or more/3mA or more	19VDC or more/3mA or more	△	The ON voltage is different.*1
OFF voltage/OFF current		6VDC or less/1.5mA or less	9.5VDC or less/1.5mA or less	△	The OFF voltage is different.*1
Input resistance		Approx. 3.4kΩ	Approx. 5.6kΩ	△	Input resistance has increased.*1
Response time	OFF to ON	0.5ms or less	0.1ms/0.2ms/0.4ms/0.6ms /1ms or less (CPU parameter setting) Initial setting is 0.2ms	○	Set the input response time of parameters to 0.4 ms.
	ON to OFF	0.5ms or less	0.1ms/0.2ms/0.4ms/0.6ms /1ms or less (CPU parameter setting) Initial setting is 0.2ms	○	
Common terminal arrangement		32 points/common (Common terminal: 1B1, 1B2, 2B1, 2B2)	32 points/common (Common terminal: 1B01, 1B02, 2B01, 2B02)	○	
Operation indication		ON indication (LED) 32 point switch-over using switch	ON indication (LED) 32 point switch-over using switch	○	
External connection method		40 pin connector (With solder) × 2	40 pin connector × 2 (Option)	○	The existing external wiring can be used without change.
Applicable wire size		0.3mm ²	0.3mm ² (For A6CON1 or A6CON4)	○	
Current consumption		0.12A (TYP. all points ON)	0.09A (TYP. all points ON)	○	
External dimensions		250 (H) × 37.5 (W) × 106 (D) mm	98 (H) × 27.4 (W) × 90 (D) mm	△	
Weight		0.51kg	0.18kg	△	

*1 Check the specifications of the sensor or switches to be connected to the QX42-S1.

*2 The following shows the derating chart.

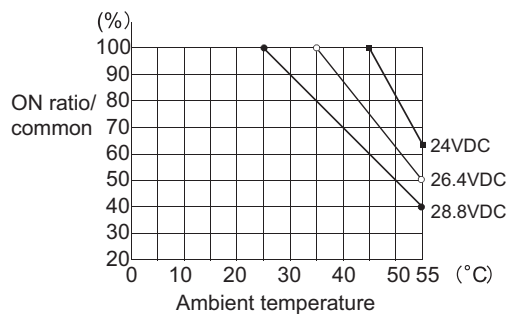

(34) Specifications comparison between AX42-S1 (when using 12VDC) and QX72

○: Compatible, △: Partial change required, ×: Incompatible

Specification		AX42-S1	QX72	Compat- ibility	Precautions for replacement
Number of input points		64 points	64 points	○	
Insulation method		Photocoupler	Photocoupler	○	
Rated input voltage		12VDC/24VDC	5VDC/12VDC	○	
Rated input current		Approx. 3mA/Approx. 7mA	5VDC Approx. 1.2mA 12VDC Approx. 3.3mA	△	Reduced.*1
Operating voltage range		10.2 to 26.4VDC (Ripple ratio within 5%)	4.5 to 6VDC (Ripple ratio within 5%) 10.2 to 14.4VDC (Ripple ratio within 5%)	○	
Maximum number of simultaneous input points		60% (20 point/common) Simultaneously ON	100% Simultaneously ON	○	
ON voltage/ON current		9.5VDC or more/3mA or more	3.5VDC or more/1mA or more	△	The ON voltage/ON current are different.*1
OFF voltage/OFF current		6VDC or less/1.5mA or less	1VDC or less/0.1mA or less	△	The OFF voltage/OFF current are different.*1
Input resistance		Approx. 3.4kΩ	Approx. 3.3kΩ	△	Input resistance has reduced.*1
Response time	OFF to ON	0.5ms or less	1ms/5ms/10ms/20ms/70ms or less (CPU parameter setting) Initial setting is 10ms	△	Response time differs. Set the time depending on control targets.
	ON to OFF	0.5ms or less	1ms/5ms/10ms/20ms/70ms or less (CPU parameter setting) Initial setting is 10ms	△	
Common terminal arrangement		32 points/common (Common terminal: 1B1, 1B2, 2B1, 2B2)	32 points/common (Common terminal: 1B01, 1B02, 2B01, 2B02)	○	
Operation indication		ON indication (LED) 32 point switch-over using switch	ON indication (LED) 32 point switch-over using switch	○	
External connection method		40 pin connector (With solder) × 2	40 pin connector × 2 (Option)	○	The existing external wiring can be used without change.
Applicable wire size		0.3mm ²	0.3mm ² (For A6CON1 or A6CON4)	○	
Current consumption		0.12A (TYP. all points ON)	0.085A (TYP. all points ON)	○	
External dimensions		250 (H) × 37.5 (W) × 106 (D) mm	98 (H) × 27.4 (W) × 90 (D) mm	△	
Weight		0.51kg	0.13kg	△	

*1 Check the specifications of the sensor or switches to be connected to the QX72.

(35) Specifications comparison between AX50(S1) and QX50

○: Compatible, △: Partial change required, ×: Incompatible

Specification	AX50(S1) *1	QX50		Compat- ibility	Precautions for replacement
Number of input points	16 points	16 points		○	
Insulation method	Photocoupler	Photocoupler		○	
Rated input voltage	48VDC	48VDC	48VAC	○	
Rated input current	4mA	Approx. 4mA		○	
Operating voltage range	38.4 to 57.6VDC (Ripple ratio within 5%)	40.8 to 57.6VDC (Ripple ratio within 5%)	40.8 to 52.8VAC (Ripple ratio within 5%)	○	
Maximum number of simultaneous input points	100% (8 points/common) Simultaneously ON	Refer to the derating chart. *2		△	Use it within the range shown in the derating chart.
ON voltage/ON current	34VDC or more 3.0mA or more	28VDC or more/2.5mA or more		○	
OFF voltage/OFF current	10VDC or less 1.0mA or less	10VDC or less/1.0mA or less		○	
Input resistance	Approx. 11kΩ	Approx. 11.2kΩ		○	
Response time	OFF to ON	10ms or less	5ms or less	15ms or less	○
	ON to OFF	10ms or less	20ms or less	20ms or less	○
Common terminal arrangement	8 points/common (Common terminal : TB9, TB18)	16 points/common (Common terminal:TB17)		△	As the common changes from two commons to a common, wiring with a different voltage for each common is not possible.
Operation indication	ON indication (LED)	ON indication (LED)		○	
External connection method	20-point terminal block connector (M3 × 6 screws)	18-point terminal block (M3 × 6 screws)		×	Wiring change is required.*3
Applicable wire size	0.75 to 2mm ² (Applicable tightening torque 68.6N·cm)	0.3 to 0.75mm ² core (Outside diameter: 2.8mm or less)		×	
Applicable solderless terminal	R1.25-3, R2-3 RAV1.25-3, RAV2-3	R1.25-3 (Sleeved solderless terminals cannot be used.)		×	
Current consumption	55mA (TYP. all points ON)	50mA (TYP. all points ON)		○	
External dimensions	250 (H) × 37.5 (W) × 121 (D) mm	98 (H) × 27.4 (W) × 90 (D) mm		△	Wiring space is narrow.
Weight	0.37kg	0.13kg		△	

*1 The AX50 is sink type module and the AX50-S1 is sink/source type module.
The specifications of the AX50 and AX50-S1 shown on the table above are the same.

*2 The following shows the derating chart.

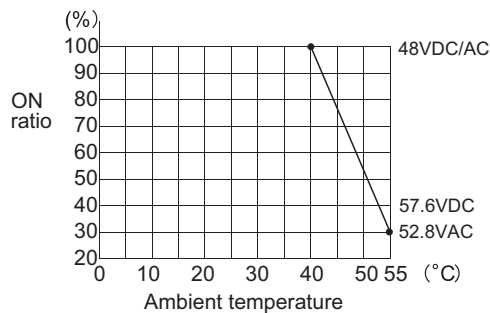

*3 The wiring change is not required by using the conversion adapter (ERNT-AQTX40) manufactured by Mitsubishi Electric Engineering Co., Ltd.

(36) Specifications comparison between AX70 (when using 24VDC and positive common) and QX40

○: Compatible, △: Partial change required, ×: Incompatible

Specification		AX70	QX40	Compat- ibility	Precautions for replacement
Number of input points		16 points	16 points	○	
Insulation method		Photocoupler	Photocoupler	○	
Rated input voltage		5VDC/12VDC/24VDC	24VDC	○	
Rated input current		3.5mA/2mA/4.5mA (TYP), 5.5mA/3mA/6mA (MAX)	Approx. 4mA	△	Reduced.*1
Operating voltage range		4.5 to 5.5VDC (SW ON), 10.2 to 26.4VDC (SW OFF)	20.4 to 28.8VDC (Ripple ratio within 5%)	○	
Maximum number of simultaneous input points		100% (8 points/common) Simultaneously ON	100% Simultaneously ON	○	
ON voltage/ON current		3.5VDC or more/1.0mA or more (SW ON), 5VDC or more/1.0mA or more (SW OFF)	19VDC or more/3mA or more	△	The ON voltage/ON current are different.*1
OFF voltage/OFF current		1.1VDC or less/ 0.2mA or less (SW ON), 2VDC or less/ 0.2mA or less (SW OFF)	11VDC or less/1.7mA or less	△	The OFF voltage/OFF current are different.*1
Input resistance		Approx. 1.4kΩ (SW ON), Approx. 5.5kΩ (SW OFF)	Approx. 5.6kΩ	△	Input resistance has increased.*1
Response time	OFF to ON	1.5ms or less	1ms/5ms/10ms/20ms/70ms or less (CPU parameter setting) Initial setting is 10ms	○	Set the input response time of parameters to 1 ms.
	ON to OFF	3ms or less	1ms/5ms/10ms/20ms/70ms or less (CPU parameter setting) Initial setting is 10ms	○	
Common terminal arrangement		8 points/common (Common terminal: TB9, TB18)	16 points/common (Common terminal: TB17)	△	As the common changes from two commons to a common, wiring with a different voltage for each common is not possible.
Operation indication		ON indication (LED)	ON indication (LED)	○	
External connection method		20-point terminal block connector (M3 × 6 screws)	18-point terminal block (M3 × 6 screws)	×	Wiring change is required.*2
Applicable wire size		0.75 to 2mm ²	0.3 to 0.75mm ² core (Outside diameter: 2.8mm or less)	×	
Applicable solderless terminal		R1.25-3, R2-3, RAV1.25-3, RAV2-3	R1.25-3 (Sleeved solderless terminals cannot be used.)	×	
Current consumption		0.055A (TYP. all points ON)	0.05A (TYP. all points ON)	○	
External dimensions		250 (H) × 37.5 (W) × 121 (D) mm	98 (H) × 27.4 (W) × 90 (D) mm	△	Wiring space is narrow.
Weight		0.36kg	0.16kg	△	

*1 Check the specifications of the sensor or switches to be connected to the QX40.

*2 The wiring change is not required by using the conversion adapter (ERNT-AQTX40) manufactured by Mitsubishi Electric Engineering Co., Ltd.

(37) Specifications comparison between AX70 (when using 24VDC and negative common) and QX80

○: Compatible, △: Partial change required, ×: Incompatible

Specification		AX70	QX80	Compat- ibility	Precautions for replacement
Number of input points		16 points	16 points	○	
Insulation method		Photocoupler	Photocoupler	○	
Rated input voltage		5VDC/12VDC/24VDC	24VDC	○	
Rated input current		3.5mA/2mA/4.5mA (TYP), 5.5mA/3mA/6mA (MAX)	Approx. 4mA	△	Reduced.*1
Operating voltage range		4.5 to 5.5VDC (SW ON), 10.2 to 26.4VDC (SW OFF)	20.4 to 28.8VDC (Ripple ratio within 5%)	○	
Maximum number of simultaneous input points		100% (8 points/common) Simultaneously ON	100% Simultaneously ON	○	
ON voltage/ON current		3.5VDC or more/1.0mA or more (SW ON), 5VDC or more/1.0mA or more (SW OFF)	19VDC or more/3mA or more	△	The ON voltage/ON current are different.*1
OFF voltage/OFF current		1.1VDC or less/ 0.2mA or less (SW ON), 2VDC or less/ 0.2mA or less (SW OFF)	11VDC or less/1.7mA or less	△	The OFF voltage/OFF current are different.*1
Input resistance		Approx. 1.4kΩ (SW ON), Approx. 5.5kΩ (SW OFF)	Approx. 5.6kΩ	△	Input resistance has increased.*1
Response time	OFF to ON	1.5ms or less	1ms/5ms/10ms/20ms/70ms or less (CPU parameter setting) Initial setting is 10ms	○	Set the input response time of parameters to 1 ms.
	ON to OFF	3ms or less	1ms/5ms/10ms/20ms/70ms or less (CPU parameter setting) Initial setting is 10ms	○	
Common terminal arrangement		8 points/common (Common terminal: TB9, TB18)	16 points/common (Common terminal: TB17)	△	As the common changes from two commons to a common, wiring with a different voltage for each common is not possible.
Operation indication		ON indication (LED)	ON indication (LED)	○	
External connection method		20-point terminal block connector (M3 × 6 screws)	18-point terminal block (M3 × 6 screws)	×	Wiring change is required.*2
Applicable wire size		0.75 to 2mm ²	0.3 to 0.75mm ² core (Outside diameter: 2.8mm or less)	×	
Applicable solderless terminal		R1.25-3, R2-3, RAV1.25-3, RAV2-3	R1.25-3 (Sleeved solderless terminals cannot be used.)	×	
Current consumption		0.055A (TYP. all points ON)	0.05A (TYP. all points ON)	○	
External dimensions		250 (H) × 37.5 (W) × 121 (D) mm	98 (H) × 27.4 (W) × 90 (D) mm	△	Wiring space is narrow.
Weight		0.36kg	0.16kg	△	

*1 Check the specifications of the sensor or switches to be connected to the QX80.

*2 The wiring change is not required by using the conversion adapter (ERNT-AQTX80) manufactured by Mitsubishi Electric Engineering Co., Ltd.

(38) Specifications comparison between AX70 (when using 5/12VDC) and QX70

○: Compatible, △: Partial change required, ×: Incompatible

Specification		AX70	QX70	Compat- ibility	Precautions for replacement
Number of input points		16 points	16 points	○	
Insulation method		Photocoupler	Photocoupler	○	
Rated input voltage		5VDC/12VDC/24VDC	5VDC/12VDC	○	
Rated input current		3.5mA/2mA/4.5mA (TYP), 5.5mA/3mA/6mA (MAX)	5VDC Approx. 1.2mA 12VDC Approx. 3.3mA	△	Reduced (5VDC). ^{*1}
Operating voltage range		4.5 to 5.5VDC (SW ON), 10.2 to 26.4VDC (SW OFF)	4.5 to 6VDC (Ripple ratio within 5%) 10.2 to 14.4VDC (Ripple ratio within 5%)	○	
Maximum number of simultaneous input points		100% (8 points/common) Simultaneously ON	100% Simultaneously ON	○	
ON voltage/ON current		3.5VDC or more/1.0mA or more (SW ON), 5VDC or more/1.0mA or more (SW OFF)	3.5VDC or more/1mA or more	△	The ON voltage is different when using 12VDC (SW OFF). ^{*1}
OFF voltage/OFF current		1.1VDC or less/ 0.2mA or less (SW ON), 2VDC or less/ 0.2mA or less (SW OFF)	1VDC or less/0.1mA or less	△	The OFF voltage/OFF current are different. ^{*1}
Input resistance		Approx. 1.4kΩ (SW ON), Approx. 5.5kΩ (SW OFF)	Approx. 3.3kΩ	△	Input resistance has increased. ^{*1}
Response time	OFF to ON	1.5ms or less	1ms/5ms/10ms/20ms/70ms or less (CPU parameter setting) Initial setting is 10ms	○	Set the input response time of parameters to 1 ms.
	ON to OFF	3ms or less	1ms/5ms/10ms/20ms/70ms or less (CPU parameter setting) Initial setting is 10ms	○	
Common terminal arrangement		8 points/common (Common terminal: TB9, TB18)	16 points/common (Common terminal: TB17)	△	As the common changes from two commons to a common, wiring with a different voltage for each common is not possible.
Operation indication		ON indication (LED)	ON indication (LED)	○	
External connection method		20-point terminal block connector (M3 × 6 screws)	18-point terminal block (M3 × 6 screws)	×	Wiring change is required. ^{*2}
Applicable wire size		0.75 to 2mm ²	0.3 to 0.75mm ² core (Outside diameter: 2.8mm or less)	×	
Applicable solderless terminal		R1.25-3, R2-3, RAV1.25-3, RAV2-3	R1.25-3 (Sleeved solderless terminals cannot be used.)	×	
Current consumption		0.055A (TYP. all points ON)	0.055A (TYP. all points ON)	○	
External dimensions		250 (H) × 37.5 (W) × 121 (D) mm	98 (H) × 27.4 (W) × 90 (D) mm	△	Wiring space is narrow.
Weight		0.36kg	0.14kg	△	

*1 Check the specifications of the sensor or switches to be connected to the QX70.

*2 The wiring change is not required by using the conversion adapter (ERNT-AQTX40) manufactured by Mitsubishi Electric Engineering Co., Ltd.

(39) Specifications comparison between AX70-UL (when using 24VDC and positive common) and QX40

○: Compatible, △: Partial change required, ×: Incompatible

Specification		AX70-UL	QX40	Compat- ibility	Precautions for replacement
Number of input points		16 points	16 points	○	
Insulation method		Photocoupler	Photocoupler	○	
Rated input voltage		5VDC/12VDC/24VDC	24VDC	○	
Rated input current		3.5mA/2mA/4.5mA (TYP), 5.5mA/3mA/6mA (MAX)	Approx. 4mA	△	Reduced.*1
Operating voltage range		5VDC (SW ON), 12/24VDC (SW OFF)	20.4 to 28.8VDC (Ripple ratio within 5%)	○	
Maximum number of simultaneous input points		100% (8 points/common) Simultaneously ON	100% Simultaneously ON	○	
ON voltage/ON current		3.5VDC or more/1.0mA or more (SW ON), 5VDC or more/1.0mA or more (SW OFF)	19VDC or more/3mA or more	△	The ON voltage/ON current are different.*1
OFF voltage/OFF current		1.1VDC or less/ 0.2mA or less (SW ON), 2VDC or less/ 0.2mA or less (SW OFF)	11VDC or less/1.7mA or less	△	The OFF voltage/OFF current are different.*1
Input resistance		Approx. 1.4kΩ (SW ON), Approx. 5.5kΩ (SW OFF)	Approx. 5.6kΩ	△	Input resistance has increased.*1
Response time	OFF to ON	1.5ms or less	1ms/5ms/10ms/20ms/70ms or less (CPU parameter setting) Initial setting is 10ms	○	Set the input response time of parameters to 1 ms.
	ON to OFF	3ms or less	1ms/5ms/10ms/20ms/70ms or less (CPU parameter setting) Initial setting is 10ms	○	
Common terminal arrangement		8 points/common (Common terminal: TB9, TB18)	16 points/common (Common terminal: TB17)	△	As the common changes from two commons to a common, wiring with a different voltage for each common is not possible.
Operation indication		ON indication (LED)	ON indication (LED)	○	
External connection method		20-point terminal block connector (M3.5 × 7 screws)	18-point terminal block (M3 × 6 screws)	×	Wiring change is required.*2
Applicable wire size		18 AWG to 14 AWG (0.75 to 2mm ²)	0.3 to 0.75mm ² core (Outside diameter: 2.8mm or less)	×	
Applicable solderless terminal		RAV1.25-3.5, RAV2-3.5	R1.25-3 (Sleeved solderless terminals cannot be used.)	×	
Current consumption		0.055A (TYP. all points ON)	0.055A (TYP. all points ON)	○	
Dielectric withstand voltage (Across external circuit and internal circuit)		Between DC external terminals and ground, 500VAC rms, 1 minute	560VAC rms/3cycles (Altitude 2,000m)	○	
Insulation resistance		5MΩ or more by insulation resistance tester	10MΩ or more by insulation resistance tester	○	
Noise durability		By noise simulator of 500Vp-p noise voltage, 1μs noise width and 25 to 60Hz noise frequency	By noise simulator of 500Vp-p noise voltage, 1μs noise width and 25 to 60Hz noise frequency First transient noise IEC61000-4-4: 1kV	○	
External dimensions		250 (H) × 37.5 (W) × 121 (D) mm	98 (H) × 27.4 (W) × 90 (D) mm	△	Wiring space is narrow.
Weight		0.36kg	0.16kg	△	

*1 Check the specifications of the sensor or switches to be connected to the QX40.

*2 The wiring change is not required by using the conversion adapter (ERNT-AQTX40) manufactured by Mitsubishi Electric Engineering Co., Ltd.

(40) Specifications comparison between AX70-UL (when using 24VDC and negative common) and QX80

○: Compatible, △: Partial change required, ×: Incompatible

Specification		AX70-UL	QX80	Compat- ibility	Precautions for replacement
Number of input points		16 points	16 points	○	
Insulation method		Photocoupler	Photocoupler	○	
Rated input voltage		5VDC/12VDC/24VDC	24VDC	○	
Rated input current		3.5mA/2mA/4.5mA (TYP), 5.5mA/3mA/6mA (MAX)	Approx. 4mA	△	Reduced.* ¹
Operating voltage range		5VDC (SW ON), 12/24VDC (SW OFF)	20.4 to 28.8VDC (Ripple ratio within 5%)	○	
Maximum number of simultaneous input points		100% (8 points/common) Simultaneously ON	100% Simultaneously ON	○	
ON voltage/ON current		3.5VDC or more/1.0mA or more (SW ON), 5VDC or more/1.0mA or more (SW OFF)	19VDC or more/3mA or more	△	The ON voltage/ON current are different.* ¹
OFF voltage/OFF current		1.1VDC or less/ 0.2mA or less (SW ON), 2VDC or less/ 0.2mA or less (SW OFF)	11VDC or less/1.7mA or less	△	The OFF voltage/OFF current are different.* ¹
Input resistance		Approx. 1.4kΩ (SW ON), Approx. 5.5kΩ (SW OFF)	Approx. 5.6kΩ	△	Input resistance has increased.* ¹
Response time	OFF to ON	1.5ms or less	1ms/5ms/10ms/20ms/70ms or less (CPU parameter setting) Initial setting is 10ms	○	Set the input response time of parameters to 1 ms.
	ON to OFF	3ms or less	1ms/5ms/10ms/20ms/70ms or less (CPU parameter setting) Initial setting is 10ms	○	
Common terminal arrangement		8 points/common (Common terminal: TB9, TB18)	16 points/common (Common terminal: TB18)	△	As the common changes from two commons to a common, wiring with a different voltage for each common is not possible.
Operation indication		ON indication (LED)	ON indication (LED)	○	
External connection method		20-point terminal block connector (M3.5 × 7 screws)	18-point terminal block (M3 × 6 screws)	×	Wiring change is required.* ²
Applicable wire size		18 AWG to 14 AWG (0.75 to 2mm ²)	0.3 to 0.75mm ² core (Outside diameter: 2.8mm or less)	×	
Applicable solderless terminal		RAV1.25-3.5, RAV2-3.5	R1.25-3 (Sleeved solderless terminals cannot be used.)	×	
Current consumption		0.055A (TYP. all points ON)	0.055A (TYP. all points ON)	○	
Dielectric withstand voltage (Across external circuit and internal circuit)		Between DC external terminals and ground, 500VAC rms, 1 minute	560VAC rms/3cycles (Altitude 2,000m)	○	
Insulation resistance		5MΩ or more by insulation resistance tester	10MΩ or more by insulation resistance tester	○	
Noise durability		By noise simulator of 500Vp-p noise voltage, 1μs noise width and 25 to 60Hz noise frequency	By noise simulator of 500Vp-p noise voltage, 1μs noise width and 25 to 60Hz noise frequency First transient noise IEC61000-4-4: 1kV	○	
External dimensions		250 (H) × 37.5 (W) × 121 (D) mm	98 (H) × 27.4 (W) × 90 (D) mm	△	Wiring pace is narrow.
Weight		0.36kg	0.16kg	△	

*1 Check the specifications of the sensor or switches to be connected to the QX80.

*2 The wiring change is not required by using the conversion adapter (ERNT-AQTX80) manufactured by Mitsubishi Electric Engineering Co., Ltd.

(41) Specifications comparison between AX70-UL (when using 5/12VDC) and QX70

○: Compatible, △: Partial change required, ×: Incompatible

Specification		AX70-UL	QX70	Compat- ibility	Precautions for replacement
Number of input points		16 points	16 points	○	
Insulation method		Photocoupler	Photocoupler	○	
Rated input voltage		5VDC/12VDC/24VDC	5VDC/12VDC	○	
Rated input current		3.5mA/2mA/4.5mA (TYP), 5.5mA/3mA/6mA (MAX)	5VDC Approx. 1.2mA 12VDC Approx. 3.3mA	△	Reduced (5VDC). ^{*1}
Operating voltage range		5VDC (SW ON), 12/24VDC (SW OFF)	4.5 to 6VDC (Ripple ratio within 5%) 10.2 to 14.4VDC (Ripple ratio within 5%)	○	
Maximum number of simultaneous input points		100% (8 points/common) Simultaneously ON	100% Simultaneously ON	○	
ON voltage/ON current		3.5VDC or more/1.0mA or more (SW ON), 5VDC or more/1.0mA or more (SW OFF)	3.5VDC or more/1mA or more	△	The ON voltage is different when using 12VDC (SW OFF). ^{*1}
OFF voltage/OFF current		1.1VDC or less/ 0.2mA or less (SW ON), 2VDC or less/ 0.2mA or less (SW OFF)	1VDC or less/0.1mA or less	△	The OFF voltage/OFF current are different. ^{*1}
Input resistance		Approx. 1.4kΩ (SW ON), Approx. 5.5kΩ (SW OFF)	Approx. 3.3kΩ	△	Input resistance has increased. ^{*1}
Response time	OFF to ON	1.5ms or less	1ms/5ms/10ms/20ms/70ms or less (CPU parameter setting) Initial setting is 10ms	○	Set the input response time of parameters to 1 ms.
	ON to OFF	3ms or less	1ms/5ms/10ms/20ms/70ms or less (CPU parameter setting) Initial setting is 10ms	○	
Common terminal arrangement		8 points/common (Common terminal: TB9, TB18)	16 points/common (Common terminal: TB17)	△	As the common changes from two commons to a common, wiring with a different voltage for each common is not possible.
Operation indication		ON indication (LED)	ON indication (LED)	○	
External connection method		20-point terminal block connector (M3.5 × 7 screws)	18-point terminal block (M3 × 6 screws)	×	Wiring change is required. ^{*2}
Applicable wire size		18 AWG to 14 AWG (0.75 to 2mm ²)	0.3 to 0.75mm ² core (Outside diameter: 2.8mm or less)	×	
Applicable solderless terminal		RAV1.25-3.5, RAV2-3.5	R1.25-3 (Sleeved solderless terminals cannot be used.)	×	
Current consumption		0.055A (TYP. all points ON)	0.055A (TYP. all points ON)	○	
Dielectric withstand voltage (Across external circuit and internal circuit)		Between DC external terminals and ground, 500VAC rms, 1 minute	560VAC rms/3cycles (Altitude 2,000m)	○	
Insulation resistance		5MΩ or more by insulation resistance tester	10MΩ or more by insulation resistance tester	○	
Noise durability		By noise simulator of 500Vp-p noise voltage, 1μs noise width and 25 to 60Hz noise frequency	By noise simulator of 500Vp-p noise voltage, 1μs noise width and 25 to 60Hz noise frequency First transient noise IEC61000-4-4: 1kV	○	
External dimensions		250 (H) × 37.5 (W) × 121 (D) mm	98 (H) × 27.4 (W) × 90 (D) mm	△	Wiring space is narrow.
Weight		0.36kg	0.14kg	△	

*1 Check the specifications of the sensor or switches to be connected to the QX70.

*2 The wiring change is not required by using the conversion adapter (ERNT-AQTX40) manufactured by Mitsubishi Electric Engineering Co., Ltd.

(42) Specifications comparison between AX71 (when using 24VDC and positive common) and QX41

○: Compatible, △: Partial change required, ×: Incompatible

Specification		AX71	QX41	Compat- ibility	Precautions for replacement
Number of input points		32 points	32 points	○	
Insulation method		Photocoupler	Photocoupler	○	
Rated input voltage		5VDC/12VDC/24VDC	24VDC	○	
Rated input current		3.5mA/2mA/4.5mA (TYP), 5.5mA/3mA/6mA (MAX)	Approx. 4mA	△	Reduced.*1
Operating voltage range		4.5 to 5.5VDC (SW ON), 10.2 to 26.4VDC (SW OFF)	20.4 to 28.8VDC (Ripple ratio within 5%)	○	
Maximum number of simultaneous input points		100% (8 points/common) Simultaneously ON	Refer to the derating chart.*3	△	Use it within the range shown in the derating chart.
ON voltage/ON current		3.5VDC or more/ 1.0mA or more (SW ON), 5VDC or more/ 1.0mA or more (SW OFF)	19VDC or more/3mA or more	△	The ON voltage/ON current are different.*1
OFF voltage/OFF current		1.1VDC or less/ 0.2mA or less (SW ON), 2VDC or less/ 0.2mA or less (SW OFF)	11VDC or less/1.7mA or less	△	The OFF voltage/OFF current are different.*1
Input resistance		Approx. 1.4kΩ (SW ON) , Approx. 5.5kΩ (SW OFF)	Approx. 5.6kΩ	△	Input resistance has increased.*1
Response time	OFF to ON	1.5ms or less	1ms/5ms/10ms/20ms/70ms or less (CPU parameter setting) Initial setting is 10ms	○	Set the input response time of parameters to 1ms.
	ON to OFF	3ms or less	1ms/5ms/10ms/20ms/70ms or less (CPU parameter setting) Initial setting is 10ms	○	
Common terminal arrangement		8 points/common (Common terminal: TB9, TB18, TB27, TB36)	32 points/common (Common terminal: B01, B02)	△	As the common changes from four commons to a common, wiring with a different voltage for each common is not possible.
Operation indication		ON indication (LED)	ON indication (LED)	○	
External connection method		38-point terminal block connector (M3 × 6 screws)	40 pin connector (Option)	×	Wiring change is required.*2
Applicable wire size		0.75 to 2mm ²	0.3mm ² (For A6CON1 or A6CON4)	×	
Applicable solderless terminal		R1.25-3, R2-3, RAV1.25-3, RAV2-3	—	×	
Current consumption		0.11A (TYP. all points ON)	0.075A (TYP. all points ON)	○	
External dimensions		250 (H) × 37.5 (W) × 131 (D) mm	98 (H) × 27.4 (W) × 90 (D) mm	△	
Weight		0.45kg	0.15kg	△	

*1 Check the specifications of the sensor or switches to be connected to the QX41.

*2 The wiring change is not required by using the conversion adapter (ERNT-AQTX41) manufactured by Mitsubishi Electric Engineering Co., Ltd. By using the conversion module such as the FA-TB32XY, conversion to the terminal block is possible.

*3 The following shows the derating chart.

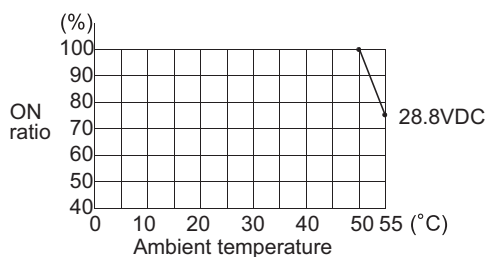

(43) Specifications comparison between AX71 (when using 24VDC and positive common) and QX41-S2

○: Compatible, △: Partial change required, ×: Incompatible

Specification		AX71	QX41-S2	Compat- ibility	Precautions for replacement
Number of input points		32 points	32 points	○	
Insulation method		Photocoupler	Photocoupler	○	
Rated input voltage		5VDC/12VDC/24VDC	24VDC	○	
Rated input current		3.5mA/2mA/4.5mA (TYP), 5.5mA/3mA/6mA (MAX)	Approx. 6mA	○	
Operating voltage range		4.5 to 5.5VDC (SW ON), 10.2 to 26.4VDC (SW OFF)	20.4 to 28.8VDC (Ripple ratio within 5%)	○	
Maximum number of simultaneous input points		100% (8 points/common) Simultaneously ON	Refer to the derating chart.*3	△	Use it within the range shown in the derating chart.
ON voltage/ON current		3.5VDC or more/ 1.0mA or more (SW ON), 5VDC or more/ 1.0mA or more (SW OFF)	15VDC or more/3mA or more	△	The ON voltage/ON current are different.*1
OFF voltage/OFF current		1.1VDC or less/ 0.2mA or less (SW ON), 2VDC or less/ 0.2mA or less (SW OFF)	5VDC or less/1.7mA or less	△	The OFF voltage/OFF current are different.*1
Input resistance		Approx. 1.4kΩ (SW ON) , Approx. 5.5kΩ (SW OFF)	Approx. 3.6kΩ	△	Input resistance has reduced.*1
Response time	OFF to ON	1.5ms or less	1ms/5ms/10ms/20ms/70ms or less (CPU parameter setting) Initial setting is 10ms	○	Set the input response time of parameters to 1ms.
	ON to OFF	3ms or less	1ms/5ms/10ms/20ms/70ms or less (CPU parameter setting) Initial setting is 10ms	○	
Common terminal arrangement		8 points/common (Common terminal: TB9, TB18, TB27, TB36)	32 points/common (Common terminal: B01, B02)	△	As the common changes from four commons to a common, wiring with a different voltage for each common is not possible.
Operation indication		ON indication (LED)	ON indication (LED)	○	
External connection method		38-point terminal block connector (M3 × 6 screws)	40 pin connector (Option)	×	Wiring change is required.*2
Applicable wire size		0.75 to 2mm ²	0.3mm ² (For A6CON1 or A6CON4)	×	
Applicable solderless terminal		R1.25-3, R2-3, RAV1.25-3, RAV2-3	-	×	
Current consumption		0.11A (TYP. all points ON)	0.07A (TYP. all points ON)	○	
External dimensions		250 (H) × 37.5 (W) × 131 (D) mm	98 (H) × 27.4 (W) × 90 (D) mm	△	
Weight		0.45kg	0.15kg	△	

*1 Check the specifications of the sensor or switches to be connected to the QX41-S2.

*2 The wiring change is not required by using the conversion adapter (ERNT-AQTX41) manufactured by Mitsubishi Electric Engineering Co., Ltd. By using the conversion module such as the FA-TB32XY, conversion to the terminal block is possible.

*3 The following shows the derating chart.

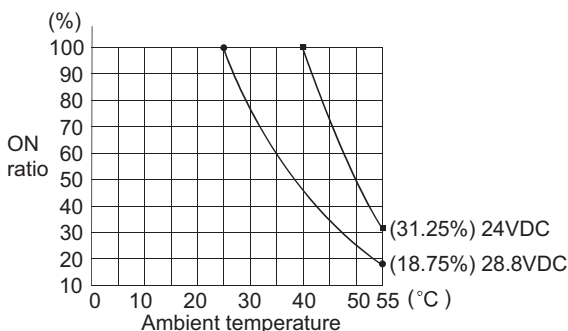

(44) Specifications comparison between AX71 (when using 24VDC and negative common) and QX81

○: Compatible, △: Partial change required, ×: Incompatible

Specification		AX71	QX81	Compat- ibility	Precautions for replacement
Number of input points		32 points	32 points	○	
Insulation method		Photocoupler	Photocoupler	○	
Rated input voltage		5VDC/12VDC/24VDC	24VDC	○	
Rated input current		3.5mA/2mA/4.5mA (TYP), 5.5mA/3mA/6mA (MAX)	Approx. 4mA	△	Reduced.*1
Operating voltage range		4.5 to 5.5VDC (SW ON), 10.2 to 26.4VDC (SW OFF)	20.4 to 28.8VDC (Ripple ratio within 5%)	○	
Maximum number of simultaneous input points		100% (8 points/common) Simultaneously ON	Refer to the derating chart.*3	△	Use it within the range shown in the derating chart.
ON voltage/ON current		3.5VDC or more/ 1.0mA or more (SW ON), 5VDC or more/ 1.0mA or more (SW OFF)	19VDC or more/3mA or more	△	The ON voltage/ON current are different.*1
OFF voltage/OFF current		1.1VDC or less/ 0.2mA or less (SW ON), 2VDC or less/ 0.2mA or less (SW OFF)	11VDC or less/1.7mA or less	△	The OFF voltage/OFF current are different.*1
Input resistance		Approx. 1.4kΩ (SW ON) , Approx. 5.5kΩ (SW OFF)	Approx. 5.6kΩ	△	Input resistance has increased.*1
Response time	OFF to ON	1.5ms or less	1ms/5ms/10ms/20ms/70ms or less (CPU parameter setting) Initial setting is 10ms	○	Set the input response time of parameters to 1ms.
	ON to OFF	3ms or less	1ms/5ms/10ms/20ms/70ms or less (CPU parameter setting) Initial setting is 10ms	○	
Common terminal arrangement		8 points/common (Common terminal: TB9, TB18, TB27, TB36)	32 points/common (Common terminal: 17, 18, 36)	△	As the common changes from four commons to a common, wiring with a different voltage for each common is not possible.
Operation indication		ON indication (LED)	ON indication (LED)	○	
External connection method		38-point terminal block connector (M3 × 6 screws)	37 pin D-sub connector (Option)	×	Wiring change is required.*2
Applicable wire size		0.75 to 2mm ²	0.3mm ² (For A6CON1E)	×	
Applicable solderless terminal		R1.25-3, R2-3, RAV1.25-3, RAV2-3	-	×	
Current consumption		0.11A (TYP. all points ON)	0.075A (TYP. all points ON)	○	
External dimensions		250 (H) × 37.5 (W) × 131 (D) mm	98 (H) × 27.4 (W) × 90 (D) mm	△	
Weight		0.45kg	0.16kg	△	

*1 Check the specifications of the sensor or switches to be connected to the QX81.

*2 The wiring change is not required by using the conversion adapter (ERNT-AQTX81) manufactured by Mitsubishi Electric Engineering Co., Ltd. By using the conversion module such as the FA-TB32XY, conversion to the terminal block is possible.

*3 The following shows the derating chart.

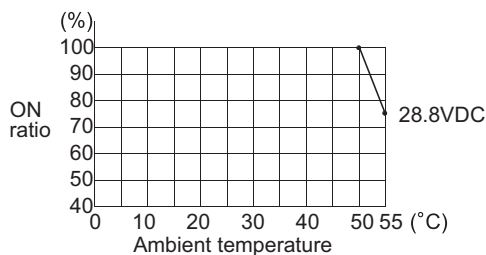

(45) Specifications comparison between AX71 (when using 24VDC and negative common) and QX81-S2

○: Compatible, △: Partial change required, ×: Incompatible

Specification		AX71	QX81-S2	Compat- ibility	Precautions for replacement
Number of input points		32 points	32 points	○	
Insulation method		Photocoupler	Photocoupler	○	
Rated input voltage		5VDC/12VDC/24VDC	24VDC	○	
Rated input current		3.5mA/2mA/4.5mA (TYP), 5.5mA/3mA/6mA (MAX)	Approx. 6mA	○	
Operating voltage range		4.5 to 5.5VDC (SW ON), 10.2 to 26.4VDC (SW OFF)	20.4 to 28.8VDC (Ripple ratio within 5%)	○	
Maximum number of simultaneous input points		100% (8 points/common) Simultaneously ON	Refer to the derating chart.*3	△	Use it within the range shown in the derating chart.
ON voltage/ON current		3.5VDC or more/ 1.0mA or more (SW ON), 5VDC or more/ 1.0mA or more (SW OFF)	15VDC or more/3mA or more	△	The ON voltage/ON current are different.*1
OFF voltage/OFF current		1.1VDC or less/ 0.2mA or less (SW ON), 2VDC or less/ 0.2mA or less (SW OFF)	5VDC or less/1.7mA or less	△	The OFF voltage/OFF current are different.*1
Input resistance		Approx. 1.4kΩ (SW ON) , Approx. 5.5kΩ (SW OFF)	Approx. 3.6kΩ	△	Input resistance has reduced.*1
Response time	OFF to ON	1.5ms or less	1ms/5ms/10ms/20ms/70ms or less (CPU parameter setting) Initial setting is 10ms	○	Set the input response time of parameters to 1ms.
	ON to OFF	3ms or less	1ms/5ms/10ms/20ms/70ms or less (CPU parameter setting) Initial setting is 10ms	○	
Common terminal arrangement		8 points/common (Common terminal: TB9, TB18, TB27, TB36)	32 points/common (Common terminal: 17, 18, 36)	△	As the common changes from four commons to a common, wiring with a different voltage for each common is not possible.
Operation indication		ON indication (LED)	ON indication (LED)	○	
External connection method		38-point terminal block connector (M3 × 6 screws)	37 pin D-sub connector (Option)	×	Wiring change is required.*2
Applicable wire size		0.75 to 2mm ²	0.3mm ² (For A6CON1E)	×	
Applicable solderless terminal		R1.25-3, R2-3, RAV1.25-3, RAV2-3	—	×	
Current consumption		0.11A (TYP. all points ON)	0.075A (TYP. all points ON)	○	
External dimensions		250 (H) × 37.5 (W) × 131 (D) mm	98 (H) × 27.4 (W) × 90 (D) mm	△	
Weight		0.45kg	0.16kg	△	

*1 Check the specifications of the sensor or switches to be connected to the QX81-S2.

*2 The wiring change is not required by using the conversion adapter (ERNT-AQTX81) manufactured by Mitsubishi Electric Engineering Co., Ltd. By using the conversion module such as the FA-TB32XY, conversion to the terminal block is possible.

*3 The following shows the derating chart.

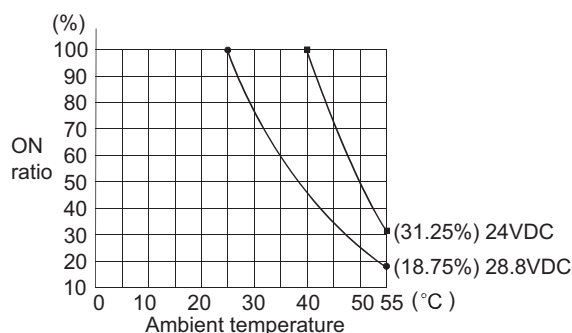

(46) Specifications comparison between AX71 (when using 5/12VDC) and QX71

○: Compatible, △: Partial change required, ×: Incompatible

Specification		AX71	QX71	Compat- ibility	Precautions for replacement
Number of input points		32 points	32 points	○	
Insulation method		Photocoupler	Photocoupler	○	
Rated input voltage		5VDC/12VDC/24VDC	5VDC/12VDC	○	
Rated input current		3.5mA/2mA/4.5mA (TYP), 5.5mA/3mA/6mA (MAX)	5VDC Approx. 1.2mA 12VDC Approx. 3.3mA	△	Reduced (5VDC). ^{*1}
Operating voltage range		4.5 to 5.5VDC (SW ON), 10.2 to 26.4VDC (SW OFF)	4.5 to 6VDC (Ripple ratio within 5%) 10.2 to 14.4VDC (Ripple ratio within 5%)	○	
Maximum number of simultaneous input points		100% (8 points/common) Simultaneously ON	100% Simultaneously ON	○	
ON voltage/ON current		3.5VDC or more/ 1.0mA or more (SW ON), 5VDC or more/ 1.0mA or more (SW OFF)	3.5VDC or more/1mA or more	○	
OFF voltage/OFF current		1.1VDC or less/ 0.2mA or less (SW ON), 2VDC or less/ 0.2mA or less (SW OFF)	1VDC or less/0.1mA or less	△	The OFF voltage/OFF current are different. ^{*1}
Input resistance		Approx. 1.4kΩ (SW ON) , Approx. 5.5kΩ (SW OFF)	Approx. 3.3kΩ	△	Input resistance has increased. ^{*1}
Response time	OFF to ON	1.5ms or less	1ms/5ms/10ms/20ms/70ms or less (CPU parameter setting) Initial setting is 10ms	○	Set the input response time of parameters to 1 ms.
	ON to OFF	3ms or less	1ms/5ms/10ms/20ms/70ms or less (CPU parameter setting) Initial setting is 10ms	○	
Common terminal arrangement		8 points/common (Common terminal: TB9, TB18, TB27, TB36)	32 points/common (Common terminal: B01, B02)	△	As the common changes from four commons to a common, wiring with a different voltage for each common is not possible.
Operation indication		ON indication (LED)	ON indication (LED)	○	
External connection method		38-point terminal block connector (M3 × 6 screws)	40 pin connector (Option)	×	Wiring change is required. ^{*2}
Applicable wire size		0.75 to 2mm ²	0.3mm ² (For A6CON1 or A6CON4)	×	
Applicable solderless terminal		R1.25-3, R2-3, RAV1.25-3, RAV2-3	—	×	
Current consumption		0.11A (TYP. all points ON)	0.07A (TYP. all points ON)	○	
External dimensions		250 (H) × 37.5 (W) × 131 (D) mm	98 (H) × 27.4 (W) × 90 (D) mm	△	
Weight		0.45kg	0.12kg	△	

*1 Check the specifications of the sensor or switches to be connected to the QX71.

*2 The wiring change is not required by using the conversion adapter (ERNT-AQTX41) manufactured by Mitsubishi Electric Engineering Co., Ltd. By using the conversion module such as the FA-TB32XY, conversion to the terminal block is possible.

(47) Specifications comparison between AX80 (when using 24VDC) and QX80

○: Compatible, △: Partial change required, ×: Incompatible

Specification		AX80	QX80	Compat- ibility	Precautions for replacement
Number of input points		16 points	16 points	○	
Insulation method		Photocoupler	Photocoupler	○	
Rated input voltage		12VDC/24VDC	24VDC	○	
Rated input current		4mA/10mA	Approx. 4mA	△	Reduced.*1
Operating voltage range		10.2 to 26.4VDC (Ripple ratio within 5%)	20.4 to 28.8VDC (Ripple ratio within 5%)	○	
Maximum number of simultaneous input points		100% (8 points/common) Simultaneously ON	100% Simultaneously ON	○	
ON voltage/ON current		9.5VDC or more/3mA or more	19VDC or more/3mA or more	△	The ON voltage is different.*1
OFF voltage/OFF current		6VDC or less/1.5mA or less	11VDC or less/1.7mA or less	△	The OFF voltage/OFF current are different.*1
Input resistance		Approx. 2.4kΩ	Approx. 5.6kΩ	△	Input resistance has increased.*1
Response time	OFF to ON	10ms or less	1ms/5ms/10ms/20ms/70ms or less (CPU parameter setting) Initial setting is 10ms	○	Use initial value (10ms) for the input response time of parameters.
	ON to OFF	10ms or less	1ms/5ms/10ms/20ms/70ms or less (CPU parameter setting) Initial setting is 10ms	○	
Common terminal arrangement		8 points/common (Common terminal: TB9, TB18)	16 points/common (Common terminal: TB18)	△	As the common changes from two commons to a common, wiring with a different voltage for each common is not possible.
Operation indication		ON indication (LED)	ON indication (LED)	○	
External connection method		20-point terminal block connector (M3 × 6 screws)	18-point terminal block (M3 × 6 screws)	×	Wiring change is required.*2
Applicable wire size		0.75 to 2mm ²	0.3 to 0.75mm ² core (Outside diameter: 2.8mm or less)	×	
Applicable solderless terminal		R1.25-3, R2-3, RAV1.25-3, RAV2-3	R1.25-3 (Sleeved solderless terminals cannot be used.)	×	
Current consumption		0.055A (TYP. all points ON)	0.05A (TYP. all points ON)	○	
External dimensions		250 (H) × 37.5 (W) × 121 (D) mm	98 (H) × 27.4 (W) × 90 (D) mm	△	Wiring space is narrow.
Weight		0.36kg	0.16kg	△	

*1 Check the specifications of the sensor or switches to be connected to the QX80.

*2 The wiring change is not required by using the conversion adapter (ERNT-AQTX80) manufactured by Mitsubishi Electric Engineering Co., Ltd.

(48) Specifications comparison between AX80 (when using 12VDC) and QX70

○: Compatible, △: Partial change required, ×: Incompatible

Specification		AX80	QX70	Compat- ibility	Precautions for replacement
Number of input points		16 points	16 points	○	
Insulation method		Photocoupler	Photocoupler	○	
Rated input voltage		12VDC/24VDC	5VDC/12VDC	○	
Rated input current		4mA/10mA	5VDC Approx. 1.2mA 12VDC Approx. 3.3mA	△	Reduced.*1
Operating voltage range		10.2 to 26.4VDC (Ripple ratio within 5%)	4.5 to 6VDC (Ripple ratio within 5%) 10.2 to 14.4VDC (Ripple ratio within 5%)	○	
Maximum number of simultaneous input points		100% (8 points/common) Simultaneously ON	100% Simultaneously ON	○	
ON voltage/ON current		9.5VDC or more/3mA or more	3.5VDC or more/1mA or more	△	The ON voltage/ON current are different.*1
OFF voltage/OFF current		6VDC or less/1.5mA or less	1VDC or less/0.1mA or less	△	The OFF voltage/OFF current are different.*1
Input resistance		Approx. 2.4kΩ	Approx. 3.3kΩ	△	Input resistance has increased.*1
Response time	OFF to ON	10ms or less	1ms/5ms/10ms/20ms/70ms or less (CPU parameter setting) Initial setting is 10ms	○	Use initial value (10ms) for the input response time of parameters.
	ON to OFF	10ms or less	1ms/5ms/10ms/20ms/70ms or less (CPU parameter setting) Initial setting is 10ms	○	
Common terminal arrangement		8 points/common (Common terminal: TB9, TB18)	16 points/common (Common terminal: TB17)	△	As the common changes from two commons to a common, wiring with a different voltage for each common is not possible.
Operation indication		ON indication (LED)	ON indication (LED)	○	
External connection method		20-point terminal block connector (M3 × 6 screws)	18-point terminal block (M3 × 6 screws)	×	Wiring change is required.*2
Applicable wire size		0.75 to 2mm ²	0.3 to 0.75mm ² core (Outside diameter: 2.8mm or less)	×	
Applicable solderless terminal		R1.25-3, R2-3, RAV1.25-3, RAV2-3	R1.25-3 (Sleeved solderless terminals cannot be used.)	×	
Current consumption		0.055A (TYP. all points ON)	0.055A (TYP. all points ON)	○	
External dimensions		250 (H) × 37.5 (W) × 121 (D) mm	98 (H) × 27.4 (W) × 90 (D) mm	△	Wiring space is narrow.
Weight		0.36kg	0.14kg	△	

*1 Check the specifications of the sensor or switches to be connected to the QX70.

*2 The wiring change is not required by using the conversion adapter (ERNT-AQTX40) manufactured by Mitsubishi Electric Engineering Co., Ltd.

(49) Specifications comparison between AX80-UL (when using 24VDC) and QX80

○: Compatible, △: Partial change required, ×: Incompatible

Specification		AX80-UL	QX80	Compat- ibility	Precautions for replacement
Number of input points		16 points	16 points	○	
Insulation method		Photocoupler	Photocoupler	○	
Rated input voltage		12VDC/24VDC	24VDC	○	
Rated input current		4mA/10mA	Approx. 4mA	△	Reduced.*1
Operating voltage range		10.2 to 26.4VDC (Ripple ratio within 5%)	20.4 to 28.8VDC (Ripple ratio within 5%)	○	
Maximum number of simultaneous input points		100% (8 points/common) Simultaneously ON	100% Simultaneously ON	○	
ON voltage/ON current		9.5VDC or more/3mA or more	19VDC or more/3mA or more	△	The ON voltage is different.*1
OFF voltage/OFF current		6VDC or less/1.5mA or less	11VDC or less/1.7mA or less	△	The OFF voltage/OFF current are different.*1
Input resistance		Approx. 2.4kΩ	Approx. 5.6kΩ	△	Input resistance has increased.*1
Response time	OFF to ON	10ms	1ms/5ms/10ms/20ms/70ms or less (CPU parameter setting) Initial setting is 10ms	○	Use initial value (10ms) for the input response time of parameters.
	ON to OFF	10ms	1ms/5ms/10ms/20ms/70ms or less (CPU parameter setting) Initial setting is 10ms	○	
Common terminal arrangement		8 points/common (Common terminal: TB9, TB18)	16 points/common (Common terminal: TB18)	△	As the common changes from two commons to a common, wiring with a different voltage for each common is not possible.
Operation indication		ON indication (LED)	ON indication (LED)	○	
External connection method		20-point terminal block connector (M3.5 × 7 screws)	18-point terminal block (M3 × 6 screws)	×	Wiring change is required.*2
Applicable wire size		18 AWG to 14 AWG (0.75 to 2mm ²)	0.3 to 0.75mm ² core (Outside diameter: 2.8mm or less)	×	
Applicable solderless terminal		RAV1.25-3.5, RAV2-3.5	R1.25-3 (Sleeved solderless terminals cannot be used.)	×	
Current consumption		0.055A (TYP. all points ON)	0.05A (TYP. all points ON)	○	
Dielectric withstand voltage (Across external circuit and internal circuit)		Between DC external terminals and ground, 500VAC rms, 1 minute	560VAC rms/3cycles (Altitude 2,000m)	○	
Insulation resistance		5MΩ or more by insulation resistance tester	10MΩ or more by insulation resistance tester	○	
Noise durability		By noise simulator of 500Vp-p noise voltage, 1μs noise width and 25 to 60Hz noise frequency	By noise simulator of 500Vp-p noise voltage, 1μs noise width and 25 to 60Hz noise frequency First transient noise IEC61000-4-4: 1kV	○	
External dimensions		250 (H) × 37.5 (W) × 121 (D) mm	98 (H) × 27.4 (W) × 90 (D) mm	△	Wiring space is narrow.
Weight		0.36kg	0.16kg	△	

*1 Check the specifications of the sensor or switches to be connected to the QX80.

*2 The wiring change is not required by using the conversion adapter (ERNT-AQTX80) manufactured by Mitsubishi Electric Engineering Co., Ltd.

(50) Specifications comparison between AX80-UL (when using 12VDC) and QX70

○: Compatible, △: Partial change required, ×: Incompatible

Specification		AX80-UL	QX70	Compat- ibility	Precautions for replacement
Number of input points		16 points	16 points	○	
Insulation method		Photocoupler	Photocoupler	○	
Rated input voltage		12VDC/24VDC	5VDC/12VDC	○	
Rated input current		4mA/10mA	5VDC Approx. 1.2mA 12VDC Approx. 3.3mA	△	Reduced.*1
Operating voltage range		10.2 to 26.4VDC (Ripple ratio within 5%)	4.5 to 6VDC (Ripple ratio within 5%) 10.2 to 14.4VDC (Ripple ratio within 5%)	○	
Maximum number of simultaneous input points		100% (8 points/common) Simultaneously ON	100% Simultaneously ON	○	
ON voltage/ON current		9.5VDC or more/3mA or more	3.5VDC or more/1mA or more	△	The ON voltage/ON current are different.*1
OFF voltage/OFF current		6VDC or less/1.5mA or less	1VDC or less/0.1mA or less	△	The OFF voltage/OFF current are different.*1
Input resistance		Approx. 2.4kΩ	Approx. 3.3kΩ	△	Input resistance has increased.*1
Response time	OFF to ON	10ms	1ms/5ms/10ms/20ms/70ms or less (CPU parameter setting) Initial setting is 10ms	○	Use initial value (10ms) for the input response time of parameters.
	ON to OFF	10ms	1ms/5ms/10ms/20ms/70ms or less (CPU parameter setting) Initial setting is 10ms	○	
Common terminal arrangement		8 points/common (Common terminal: TB9, TB18)	16 points/common (Common terminal: TB17)	△	As the common changes from two commons to a common, wiring with a different voltage for each common is not possible.
Operation indication		ON indication (LED)	ON indication (LED)	○	
External connection method		20-point terminal block connector (M3.5 × 7 screws)	18-point terminal block (M3 × 6 screws)	×	Wiring change is required.
Applicable wire size		18 AWG to 14 AWG (0.75 to 2mm ²)	0.3 to 0.75mm ² core (Outside diameter: 2.8mm or less)	×	
Applicable solderless terminal		RAV1.25-3.5, RAV2-3.5	R1.25-3 (Sleeved solderless terminals cannot be used.)	×	
Current consumption		0.055A (TYP. all points ON)	0.055A (TYP. all points ON)	○	
Dielectric withstand voltage (Across external circuit and internal circuit)		Between DC external terminals and ground, 500VAC rms, 1 minute	560VAC rms/3cycles (Altitude 2,000m)	○	
Insulation resistance		5MΩ or more by insulation resistance tester	10MΩ or more by insulation resistance tester	○	
Noise durability		By noise simulator of 500Vp-p noise voltage, 1μs noise width and 25 to 60Hz noise frequency	By noise simulator of 500Vp-p noise voltage, 1μs noise width and 25 to 60Hz noise frequency First transient noise IEC61000-4-4: 0.25kV	○	
External dimensions		250 (H) × 37.5 (W) × 121 (D) mm	98 (H) × 27.4 (W) × 90 (D) mm	△	Wiring space is narrow.
Weight		0.36kg	0.14kg	△	

*1 Check the specifications of the sensor or switches to be connected to the QX70.

(51) Specifications comparison between AX80E (when using 24VDC) and QX82-S1

○: Compatible, △: Partial change required, ×: Incompatible

Specification		AX80E	QX82-S1	Compat- ibility	Precautions for replacement
Number of input points		16 points	64 points	△	Set 16 points in the I/O assignment of Parameter.
Insulation method		Photocoupler	Photocoupler	○	
Rated input voltage		12VDC/24VDC	24VDC	○	
Rated input current		4mA/10mA	Approx. 4mA	△	Reduced.*1
Operating voltage range		10.2 to 26.4VDC (Ripple ratio within 5%)	20.4 to 28.8VDC (Ripple ratio within 5%)	○	
Maximum number of simultaneous input points		100% (8 points/common) Simultaneously ON	Refer to the derating chart.*2	△	Use within the range shown in the derating figure.
ON voltage/ON current		9.5VDC or more/2.6mA or more	19VDC or more/3mA or more	△	The ON voltage/ON current are different.*1
OFF voltage/OFF current		6VDC or less/1.0mA or less	9.5VDC or less/1.5mA or less	△	The OFF voltage/OFF current are different.*1
Input resistance		Approx. 2.4kΩ	Approx. 5.6kΩ	△	Input resistance has increased.*1
Response time	OFF to ON	5.5ms (TYP.)	0.1ms/0.2ms/0.4ms/0.6ms /1ms or less (CPU parameter setting) Initial setting is 0.2ms	△	Set the input response time of parameters to 1 ms.
	ON to OFF	6.0ms (TYP.)	0.1ms/0.2ms/0.4ms/0.6ms /1ms or less (CPU parameter setting) Initial setting is 0.2ms	△	
Response time high-speed mode (upper 8 points only)	OFF to ON	0.5ms or less	0.1ms/0.2ms/0.4ms/0.6ms /1ms or less (CPU parameter setting) Initial setting is 0.2ms	○	Set the input response time of parameters to 0.4 ms.
	ON to OFF	1.0ms or less	0.1ms/0.2ms/0.4ms/0.6ms /1ms or less (CPU parameter setting) Initial setting is 0.2ms	○	
Common terminal arrangement		8 points/common (Common terminal: TB9, TB18)	32 points/common (Common terminal: 1B01, 1B02, 2B01, 2B02)	△	As the common changes from four commons to a common, wiring with a different voltage for each common is not possible.
Operation indication		ON indication (LED)	ON indication (LED) 32 point switch-over using switch	○	
External connection method		20-point terminal block connector (M3 × 6 screws)	40 pin connector × 1 (Option)	×	Wiring change is required.
Applicable wire size		0.75 to 2mm ²	0.3mm ² (For A6CON1 or A6CON4)	×	
Applicable solderless terminal		R1.25-3, R2-3, RAV1.25-3, RAV2-3	—	×	
Current consumption		0.055A (TYP. all points ON)	0.09A (TYP. all points ON)	△	Reviewing power supply capacity is required.
External dimensions		250 (H) × 37.5 (W) × 121 (D) mm	98 (H) × 27.4 (W) × 90 (D) mm	△	
Weight		0.36kg	0.18kg	△	

*1 Check the specifications of the sensor or switches to be connected to the QX82-S1.

*2 The following shows the derating chart.

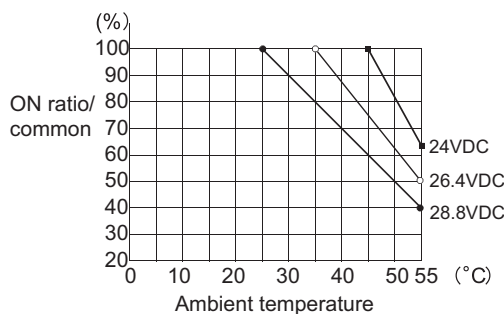

(52) Specifications comparison between AX80E (when using 12VDC) and QX70

○: Compatible, △: Partial change required, ×: Incompatible

Specification		AX80E	QX70	Compat- ibility	Precautions for replacement
Number of input points		16 points	16 points	○	
Insulation method		Photocoupler	Photocoupler	○	
Rated input voltage		12VDC/24VDC	5VDC/12VDC	○	
Rated input current		4mA/10mA	5VDC Approx. 1.2mA 12VDC Approx. 3.3mA	△	Reduced.*1
Operating voltage range		10.2 to 26.4VDC (Ripple ratio within 5%)	4.5 to 6VDC (Ripple ratio within 5%) 10.2 to 14.4VDC (Ripple ratio within 5%)	○	
Maximum number of simultaneous input points		100% (8 points/common) Simultaneously ON	100% Simultaneously ON	○	
ON voltage/ON current		9.5VDC or more/2.6mA or more	3.5VDC or more/1mA or more	△	The ON voltage/ON current are different.*1
OFF voltage/OFF current		6VDC or less/1.0mA or less	1VDC or less/0.1mA or less	△	The OFF voltage/OFF current are different.*1
Input resistance		Approx. 2.4kΩ	Approx. 3.3kΩ	△	Input resistance has increased.*1
Response time	OFF to ON	5.5ms (TYP.)	1ms/5ms/10ms/20ms/70ms or less (CPU parameter setting) Initial setting is 10ms	○	Set the input response time of parameters to 5 ms.
	ON to OFF	6.0ms (TYP.)	1ms/5ms/10ms/20ms/70ms or less (CPU parameter setting) Initial setting is 10ms	○	
Response time high-speed mode (upper 8 points only)	OFF to ON	0.5ms or less	1ms/5ms/10ms/20ms/70ms or less (CPU parameter setting) Initial setting is 10ms	○	Set the input response time of parameters to 1 ms.
	ON to OFF	1.0ms or less	1ms/5ms/10ms/20ms/70ms or less (CPU parameter setting) Initial setting is 10ms	○	
Common terminal arrangement		8 points/common (Common terminal: TB9, TB18)	16 points/common (Common terminal: TB17)	△	As the common changes from two commons to a common, wiring with a different voltage for each common is not possible.
Operation indication		ON indication (LED)	ON indication (LED)	○	
External connection method		20-point terminal block connector (M3 × 6 screws)	18-point terminal block (M3 × 6 screws)	×	Wiring change is required.
Applicable wire size		0.75 to 2mm ²	0.3 to 0.75mm ² core (Outside diameter: 2.8mm or less)	×	
Applicable solderless terminal		R1.25-3, R2-3, RAV1.25-3, RAV2-3	R1.25-3 (Sleeved solderless terminals cannot be used.)	×	
Current consumption		0.055A (TYP. all points ON)	0.055A (TYP. all points ON)	○	
External dimensions		250 (H) × 37.5 (W) × 121 (D)mm	98 (H) × 27.4 (W) × 90 (D) mm	△	Wiring space is narrow.
Weight		0.36kg	0.14kg	△	

*1 Check the specifications of the sensor or switches to be connected to the QX70.

(53) Specifications comparison between AX81 (when using 24VDC) and QX81

○: Compatible, △: Partial change required, ×: Incompatible

Specification		AX81	QX81	Compat- ibility	Precautions for replacement
Number of input points		32 points	32 points	○	
Insulation method		Photocoupler	Photocoupler	○	
Rated input voltage		12VDC/24VDC	24VDC	○	
Rated input current		4mA/10mA	Approx. 4mA	△	Reduced.*1
Operating voltage range		10.2 to 26.4VDC (Ripple ratio within 5%)	20.4 to 28.8VDC (Ripple ratio within 5%)	○	
Maximum number of simultaneous input points		60% (5 point/common) Simultaneously ON	Refer to the derating chart.*2	○	
ON voltage/ON current		9.5VDC or more/3mA or more	19VDC or more/3mA or more	△	The ON voltage is different.*1
OFF voltage/OFF current		6VDC or less/1.5mA or less	11VDC or less/1.7mA or less	△	The OFF voltage/OFF current are different.*1
Input resistance		Approx. 2.4kΩ	Approx. 5.6kΩ	△	Input resistance has increased.*1
Response time	OFF to ON	10ms or less	1ms/5ms/10ms/20ms/70ms or less (CPU parameter setting) Initial setting is 10ms	○	Use initial value (10ms) for the input response time of parameters.
	ON to OFF	10ms or less	1ms/5ms/10ms/20ms/70ms or less (CPU parameter setting) Initial setting is 10ms	○	
Common terminal arrangement		8 points/common (Common terminal: TB9, TB18, TB27, TB36)	32 points/common (Common terminal: 17, 18, 36)	△	As the common changes from four commons to a common, wiring with a different voltage for each common is not possible.
Operation indication		ON indication (LED)	ON indication (LED)	○	
External connection method		38-point terminal block connector (M3 × 6 screws)	37 pin D-sub connector (Option)	×	Wiring change is required.*3
Applicable wire size		0.75 to 2mm ²	0.3mm ² (For A6CON1E)	×	
Applicable solderless terminal		R1.25-3, R2-3, RAV1.25-3, RAV2-3	—	×	
Current consumption		0.11A (TYP. all points ON)	0.075A (TYP. all points ON)	○	
External dimensions		250 (H) × 37.5 (W) × 131 (D) mm	98 (H) × 27.4 (W) × 90 (D) mm	△	
Weight		0.45kg	0.16kg	△	

*1 Check the specifications of the sensor or switches to be connected to the QX81.

*2 The following shows the derating chart.

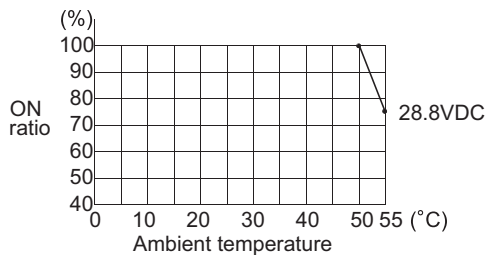

*3 The wiring change is not required by using the conversion adapter (ERNT-AQTX81) manufactured by Mitsubishi Electric Engineering Co., Ltd. By using connectors/terminal block converter modules such as the A6TBXY36-E and the conversion module such as the FA-TB32XY, conversion to the terminal block is possible.

(54) Specifications comparison between AX81 (when using 24VDC) and QX81-S2

○: Compatible, △: Partial change required, ×: Incompatible

Specification		AX81	QX81-S2	Compat- ibility	Precautions for replacement
Number of input points		32 points	32 points	○	
Insulation method		Photocoupler	Photocoupler	○	
Rated input voltage		12VDC/24VDC	24VDC	○	
Rated input current		4mA/10mA	Approx. 6mA	△	Reduced.*1
Operating voltage range		10.2 to 26.4VDC (Ripple ratio within 5%)	20.4 to 28.8VDC (Ripple ratio within 5%)	○	
Maximum number of simultaneous input points		60% (5 point/common) Simultaneously ON	Refer to the derating chart.*2	○	
ON voltage/ON current		9.5VDC or more/3mA or more	15VDC or more/3mA or more	△	The ON voltage is different.*1
OFF voltage/OFF current		6VDC or less/1.5mA or less	5VDC or less/1.7mA or less	△	The OFF voltage/OFF current are different.*1
Input resistance		Approx. 2.4kΩ	Approx. 3.6kΩ	△	Input resistance has increased.*1
Response time	OFF to ON	10ms or less	1ms/5ms/10ms/20ms/70ms or less (CPU parameter setting) Initial setting is 10ms	○	Use initial value (10ms) for the input response time of parameters.
	ON to OFF	10ms or less	1ms/5ms/10ms/20ms/70ms or less (CPU parameter setting) Initial setting is 10ms	○	
Common terminal arrangement		8 points/common (Common terminal: TB9, TB18, TB27, TB36)	32 points/common (Common terminal: 17, 18, 36)	△	As the common changes from four commons to a common, wiring with a different voltage for each common is not possible.
Operation indication		ON indication (LED)	ON indication (LED)	○	
External connection method		38-point terminal block connector (M3 × 6 screws)	37 pin D-sub connector (Option)	×	Wiring change is required.*3
Applicable wire size		0.75 to 2mm ²	0.3mm ² (For A6CON1E)	×	
Applicable solderless terminal		R1.25-3, R2-3, RAV1.25-3, RAV2-3	—	×	
Current consumption		0.11A (TYP. all points ON)	0.075A (TYP. all points ON)	○	
External dimensions		250 (H) × 37.5 (W) × 131 (D) mm	98 (H) × 27.4 (W) × 90 (D) mm	△	
Weight		0.45kg	0.16kg	△	

*1 Check the specifications of the sensor or switches to be connected to the QX81-S2.

*2 The following shows the derating chart.

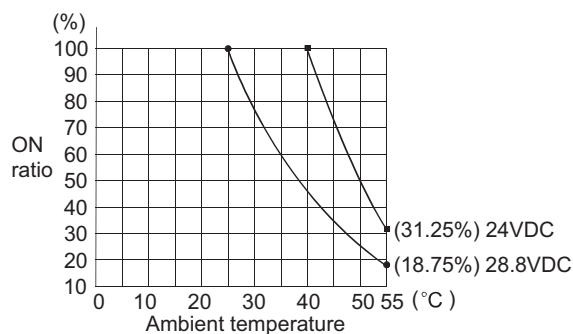

*3 The wiring change is not required by using the conversion adapter (ERNT-AQTX81) manufactured by Mitsubishi Electric Engineering Co., Ltd. By using connectors/terminal block converter modules such as the A6TBXY36-E and the conversion module such as the FA-TB32XY, conversion to the terminal block is possible.

(55) Specifications comparison between AX81 (when using 12VDC) and QX71

○: Compatible, △: Partial change required, ×: Incompatible

Specification		AX81	QX71	Compat- ibility	Precautions for replacement
Number of input points		32 points	32 points	○	
Insulation method		Photocoupler	Photocoupler	○	
Rated input voltage		12VDC/24VDC	5VDC/12VDC	○	
Rated input current		4mA/10mA	5VDC Approx. 1.2mA 12VDC Approx. 3.3mA	△	Reduced.*1
Operating voltage range		10.2 to 26.4VDC (Ripple ratio within 5%)	4.5 to 6VDC (Ripple ratio within 5%) 10.2 to 14.4VDC (Ripple ratio within 5%)	○	
Maximum number of simultaneous input points		60% (5 point/common) Simultaneously ON	100% Simultaneously ON	○	
ON voltage/ON current		9.5VDC or more/3mA or more	3.5VDC or more/1mA or more	△	The ON voltage/ON current are different.*1
OFF voltage/OFF current		6VDC or less/1.5mA or less	1VDC or less/0.1mA or less	△	The OFF voltage/OFF current are different.*1
Input resistance		Approx. 2.4kΩ	Approx. 3.3kΩ	△	Input resistance has increased.*1
Response time	OFF to ON	10ms or less	1ms/5ms/10ms/20ms/70ms or less (CPU parameter setting) Initial setting is 10ms	○	Use initial value (10ms) for the input response time of parameters.
	ON to OFF	10ms or less	1ms/5ms/10ms/20ms/70ms or less (CPU parameter setting) Initial setting is 10ms	○	
Common terminal arrangement		8 points/common (Common terminal: TB9, TB18, TB27, TB36)	32 points/common (Common terminal: B01, B02)	△	As the common changes from four commons to a common, wiring with a different voltage for each common is not possible.
Operation indication		ON indication (LED)	ON indication (LED)	○	
External connection method		38-point terminal block connector (M3 × 6 screws)	40 pin connector (Option)	×	Wiring change is required.*2
Applicable wire size		0.75 to 2mm ²	0.3mm ² (For A6CON1 or A6CON4)	×	
Applicable solderless terminal		R1.25-3, R2-3, RAV1.25-3, RAV2-3	—	×	
Current consumption		0.11A (TYP. all points ON)	0.07A (TYP. all points ON)	○	
External dimensions		250 (H) × 37.5 (W) × 131 (D) mm	98 (H) × 27.4 (W) × 90 (D) mm	△	
Weight		0.45kg	0.12kg	△	

*1 Check the specifications of the sensor or switches to be connected to the QX71.

*2 By using the conversion module such as the FA-TB32XY, conversion to the terminal block is possible.

(56) Specifications comparison between AX81B and QX81

○: Compatible, △: Partial change required, ×: Incompatible

Specification		AX81B	QX81	Compat- ibility	Precautions for replacement
Number of input points		32 points (64 points occupied)	32 points	△	Set 64 points in the I/O assignment of Parameter.
Insulation method		Photocoupler	Photocoupler	○	
Rated input voltage		24VDC	24VDC	○	
Rated input current		7mA (When turning ON an external switch) 1.5mA (When turning OFF an external switch)	Approx. 4mA	×	The wire breakage detection function is not provided.
Operating voltage range		21.6 to 30VDC (Ripple ratio within 5%)	20.4 to 28.8VDC (Ripple ratio within 5%)	△	Voltage over 28.8VDC is not applicable.
Maximum number of simultaneous input points		60% (5 points/common) Simultaneously ON	Refer to the derating chart. *1	○	
ON voltage/ON current		21.0VDC or more/5.4mA or more (Normal input) 1.0VDC or less/0.2mA or less (Wire breakage detection)	19VDC or more/3mA or more	×	The wire breakage detection function not provided.
OFF voltage/OFF current		7.0VDC or less/1.9mA or less (Normal input) 6.0VDC or more/1.3mA or more (Wire breakage detection)	11VDC or less/1.7mA or less	×	The wire breakage detection function not provided.
Input resistance		Approx. 3.6kΩ (Normal input) Approx. 4.3kΩ (Wire breakage detection)	Approx. 5.6 kΩ	×	The wire breakage detection function not provided.
Wire breakage detection		Provided	Not provided	×	The wire breakage detection function not provided.
Response time	OFF to ON	10ms or less	1ms/5ms/10ms/20ms/70ms or less (CPU parameter setting) Initial setting is 10ms	○	Use initial value (10ms) for the input response time of parameters.
	ON to OFF	10ms or less	1ms/5ms/10ms/20ms/70ms or less (CPU parameter setting) Initial setting is 10ms	○	
External resistance		0.1kΩ or less (At turning ON) 11.4 to 12.7kΩ or less (At turning OFF) 150kΩ or more (At wire breakage detection)	-	-	Since the wire breakage detection function is not provided, the external resistance is not required.
Parallel resistance with external switch		12kΩ (Tolerance: ±5%, 1/4W or more)	-	-	Since the wire breakage detection function is not provided, the external resistance is not required.
Common terminal arrangement		8 points/common (Common terminal: TB9, TB18, TB27, TB36)	32 points/common (Common terminal: 17, 18, 36)	△	As the common changes from four commons to a common, wiring with a different voltage for each common is not possible.
Operation indication		ON indication (LED) 32 point switch-over using switch	ON indication (LED)	○	
External connection method		38-point terminal block connector (M3 × 6 screws)	37 pin D-sub connector (Option)	×	Wiring change is required. *2
Applicable wire size		0.75 to 2mm ²	0.3mm ² (For A6CON1E)	×	
Applicable solderless terminal		R1.25-3, R2-3 RAV1.25-3, RAV2-3	-	×	
Current consumption		0.125A (TYP. all points ON)	0.075A (TYP. all points ON)	○	
External dimensions		250 (H) × 37.5 (W) × 131 (D) mm	98 (H) × 27.4 (W) × 90 (D) mm	△	
Weight		0.45kg	0.16kg	△	

*1 The following shows the derating chart.

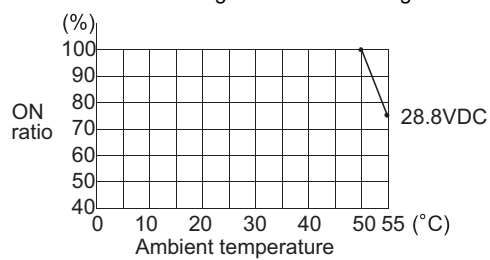

*2 By using connectors/terminal block converter modules such as the A6TBXY36-E and the conversion module such as the FA-TB32XY, conversion to the terminal block is possible.

(57) Specifications comparison between AX81-S1 (when using 24VDC and positive common) and QX41

○: Compatible, △: Partial change required, ×: Incompatible

Specification		AX81-S1	QX41	Compat- ibility	Precautions for replacement
Number of input points		32 points	32 points	○	
Insulation method		Photocoupler	Photocoupler	○	
Rated input voltage		12VDC/24VDC	24VDC	○	
Rated input current		2.5mA/5mA	Approx. 4mA	△	Reduced.*1
Operating voltage range		10.2 to 26.4VDC (Ripple ratio within 5%)	20.4 to 28.8VDC (Ripple ratio within 5%)	○	
Maximum number of simultaneous input points		60% (5 point/common) Simultaneously ON	Refer to the derating chart.*2	○	
ON voltage/ON current		5.6VDC or more/1.1mA or more	19VDC or more/3mA or more	△	The ON voltage/ON current are different.*1
OFF voltage/OFF current		2.4VDC or less/0.39mA or less	11VDC or less/1.7mA or less	△	The OFF voltage/OFF current are different.*1
Input resistance		Approx. 4.8kΩ	Approx. 5.6kΩ	△	Input resistance has increased.*1
Response time	OFF to ON	10ms or less	1ms/5ms/10ms/20ms/70ms or less (CPU parameter setting) Initial setting is 10ms	○	Use initial value (10ms) for the input response time of parameters.
	ON to OFF	10ms or less	1ms/5ms/10ms/20ms/70ms or less (CPU parameter setting) Initial setting is 10ms	○	
Common terminal arrangement		8 points/common (Common terminal: TB9, TB18, TB27, TB36)	32 points/common (Common terminal: B01, B02)	△	As the common changes from four commons to a common, wiring with a different voltage for each common is not possible.
Operation indication		ON indication (LED)	ON indication (LED)	○	
External connection method		38-point terminal block connector (M3 × 6 screws)	40 pin connector (Option)	×	Wiring change is required.*2
Applicable wire size		0.75 to 2mm ²	0.3mm ² (For A6CON1 or A6CON4)	×	
Applicable solderless terminal		R1.25-3, R2-3, RAV1.25-3, RAV2-3	—	×	
Current consumption		0.105A (TYP. all points ON)	0.075A (TYP. all points ON)	○	
External dimensions		250 (H) × 37.5 (W) × 131 (D) mm	98 (H) × 27.4 (W) × 90 (D) mm	△	
Weight		0.45kg	0.15kg	△	

*1 Check the specifications of the sensor or switches to be connected to the QX41.

*2 The following shows the derating chart.

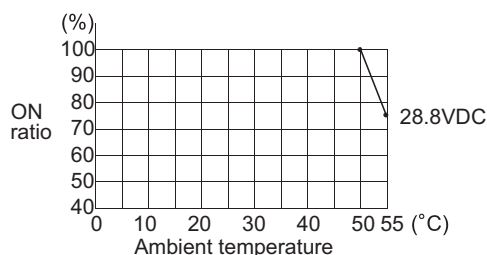

*3 The wiring change is not required by using the conversion adapter (ERNT-AQTX41) manufactured by Mitsubishi Electric Engineering Co., Ltd. By using connectors/terminal block converter modules such as the A6TBXY36-E and the conversion module such as the FA-TB32XY, conversion to the terminal block is possible.

(58) Specifications comparison between AX81-S1 (when using 24VDC and positive common) and QX41-S2

○: Compatible, △: Partial change required, ×: Incompatible

Specification	AX81-S1	QX41-S2	Compat- ibility	Precautions for replacement
Number of input points	32 points	32 points	○	
Insulation method	Photocoupler	Photocoupler	○	
Rated input voltage	12VDC/24VDC	24VDC	○	
Rated input current	2.5mA/5mA	Approx. 6mA	○	
Operating voltage range	10.2 to 26.4VDC (Ripple ratio within 5%)	20.4 to 28.8VDC (Ripple ratio within 5%)	○	
Maximum number of simultaneous input points	60% (5 point/common) Simultaneously ON	Refer to the derating chart. *2	○	
ON voltage/ON current	5.6VDC or more/1.1mA or more	15VDC or more/3mA or more	△	The ON voltage/ON current are different.*1
OFF voltage/OFF current	2.4VDC or less/0.39mA or less	5VDC or less/1.7mA or less	△	The OFF voltage/OFF current are different.*1
Input resistance	Approx. 4.8kΩ	Approx. 3.6kΩ	△	Input resistance has reduced.*1
Response time	OFF to ON	10ms or less	○	Use initial value (10ms) for the input response time of parameters.
	ON to OFF	10ms or less	○	
Common terminal arrangement	8 points/common (Common terminal: TB9, TB18, TB27, TB36)	32 points/common (Common terminal: B01, B02)	△	As the common changes from four commons to a common, wiring with a different voltage for each common is not possible.
Operation indication	ON indication (LED)	ON indication (LED)	○	
External connection method	38-point terminal block connector (M3 × 6 screws)	40 pin connector (Option)	×	Wiring change is required.*3
Applicable wire size	0.75 to 2mm ²	0.3mm ² (For A6CON1 or A6CON4)	×	
Applicable solderless terminal	R1.25-3, R2-3, RAV1.25-3, RAV2-3	-	×	
Current consumption	0.105A (TYP. all points ON)	0.075A (TYP. all points ON)	○	
External dimensions	250 (H) × 37.5 (W) × 131 (D) mm	98 (H) × 27.4 (W) × 90 (D) mm	△	
Weight	0.45kg	0.15kg	△	

*1 Check the specifications of the sensor or switches to be connected to the QX41-S2.

*2 The following shows the derating chart.

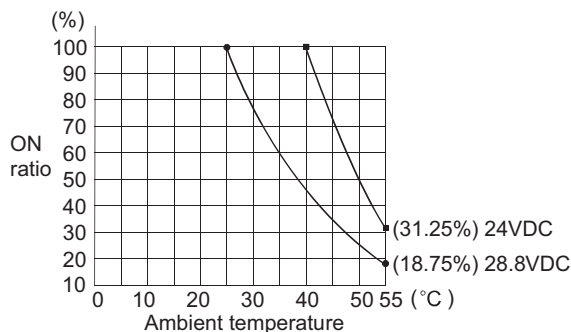

*3 The wiring change is not required by using the conversion adapter (ERNT-AQTX41) manufactured by Mitsubishi Electric Engineering Co., Ltd. By using connectors/terminal block converter modules such as the A6TBXY36-E and the conversion module such as the FA-TB32XY, conversion to the terminal block is possible.

(59) Specifications comparison between AX81-S1 (when using 24VDC and negative common) and QX81

○: Compatible, △: Partial change required, ×: Incompatible

Specification		AX81-S1	QX81	Compat- ibility	Precautions for replacement
Number of input points		32 points	32 points	○	
Insulation method		Photocoupler	Photocoupler	○	
Rated input voltage		12VDC/24VDC	24VDC	○	
Rated input current		2.5mA/5mA	Approx. 4mA	△	Reduced.*1
Operating voltage range		10.2 to 26.4VDC (Ripple ratio within 5%)	20.4 to 28.8VDC (Ripple ratio within 5%)	○	
Maximum number of simultaneous input points		60% (5 point/common) Simultaneously ON	Refer to the derating chart.*2	○	
ON voltage/ON current		5.6VDC or more/1.1mA or more	19VDC or more/3mA or more	△	The ON voltage/ON current are different.*1
OFF voltage/OFF current		2.4VDC or less/0.39mA or less	11VDC or less/1.7mA or less	△	The OFF voltage/OFF current are different.*1
Input resistance		Approx. 4.8kΩ	Approx. 5.6kΩ	△	Input resistance has increased.*1
Response time	OFF to ON	10ms or less	1ms/5ms/10ms/20ms/70ms or less (CPU parameter setting) Initial setting is 10ms	○	Use initial value (10ms) for the input response time of parameters.
	ON to OFF	10ms or less	1ms/5ms/10ms/20ms/70ms or less (CPU parameter setting) Initial setting is 10ms	○	
Common terminal arrangement		8 points/common (Common terminal: TB9, TB18, TB27, TB36)	32 points/common (Common terminal: 17, 18, 36)	△	As the common changes from four commons to a common, wiring with a different voltage for each common is not possible.
Operation indication		ON indication (LED)	ON indication (LED)	○	
External connection method		38-point terminal block connector (M3 × 6 screws)	37 pin D-sub connector (Option)	×	Wiring change is required.*3
Applicable wire size		0.75 to 2mm ²	0.3mm ² (For A6CON1E)	×	
Applicable solderless terminal		R1.25-3, R2-3, RAV1.25-3, RAV2-3	-	×	
Current consumption		0.105A (TYP. all points ON)	0.075A (TYP. all points ON)	○	
External dimensions		250 (H) × 37.5 (W) × 131 (D) mm	98 (H) × 27.4 (W) × 90 (D) mm	△	
Weight		0.45kg	0.16kg	△	

*1 Check the specifications of the sensor or switches to be connected to the QX81.

*2 The following shows the derating chart.

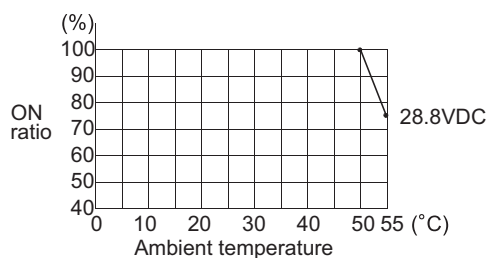

*3 The wiring change is not required by using the conversion adapter (ERNT-AQTX81) manufactured by Mitsubishi Electric Engineering Co., Ltd. By using connectors/terminal block converter modules such as the A6TBXY36-E and the conversion module such as the FA-TB32XY, conversion to the terminal block is possible.

(60) Specifications comparison between AX81-S1 (when using 24VDC and negative common) and QX81-S2

○: Compatible, △: Partial change required, ×: Incompatible

Specification		AX81-S1	QX81-S2	Compatibility	Precautions for replacement
Number of input points		32 points	32 points	○	
Insulation method		Photocoupler	Photocoupler	○	
Rated input voltage		12VDC/24VDC	24VDC	○	
Rated input current		2.5mA/5mA	Approx. 6mA	○	
Operating voltage range		10.2 to 26.4VDC (Ripple ratio within 5%)	20.4 to 28.8VDC (Ripple ratio within 5%)	○	
Maximum number of simultaneous input points		60% (5 point/common) Simultaneously ON	Refer to the derating chart. *2	○	
ON voltage/ON current		5.6VDC or more/1.1mA or more	15VDC or more/3mA or more	△	The ON voltage/ON current are different.*1
OFF voltage/OFF current		2.4VDC or less/0.39mA or less	5VDC or less/1.7mA or less	△	The OFF voltage/OFF current are different.*1
Input resistance		Approx. 4.8kΩ	Approx. 3.6kΩ	△	Input resistance has reduced.*1
Response time	OFF to ON	10ms or less	1ms/5ms/10ms/20ms/70ms or less (CPU parameter setting) Initial setting is 10ms	○	Use initial value (10ms) for the input response time of parameters.
	ON to OFF	10ms or less	1ms/5ms/10ms/20ms/70ms or less (CPU parameter setting) Initial setting is 10ms	○	
Common terminal arrangement		8 points/common (Common terminal: TB9, TB18, TB27, TB36)	32 points/common (Common terminal: 17, 18, 36)	△	As the common changes from four commons to a common, wiring with a different voltage for each common is not possible.
Operation indication		ON indication (LED)	ON indication (LED)	○	
External connection method		38-point terminal block connector (M3 × 6 screws)	37 pin D-sub connector (Option)	×	Wiring change is required.*3
Applicable wire size		0.75 to 2mm ²	0.3mm ² (For A6CON1E)	×	
Applicable solderless terminal		R1.25-3, R2-3, RAV1.25-3, RAV2-3	—	×	
Current consumption		0.105A (TYP. all points ON)	0.075A (TYP. all points ON)	○	
External dimensions		250 (H) × 37.5 (W) × 131 (D) mm	98 (H) × 27.4 (W) × 90 (D) mm	△	
Weight		0.45kg	0.16kg	△	

*1 Check the specifications of the sensor or switches to be connected to the QX81-S2.

*2 The following shows the derating chart.

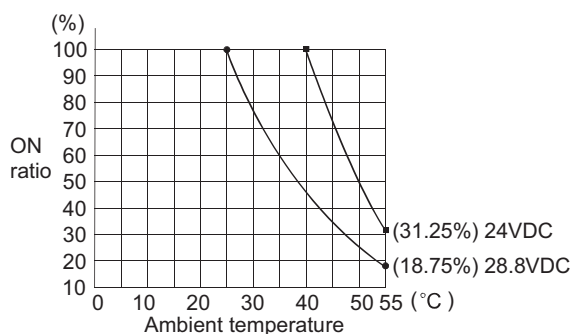

*3 The wiring change is not required by using the conversion adapter (ERNT-AQTX81) manufactured by Mitsubishi Electric Engineering Co., Ltd. By using connectors/terminal block converter modules such as the A6TBXY36-E and the conversion module such as the FA-TB32XY, conversion to the terminal block is possible.

(61) Specifications comparison between AX81-S1 (when using 12VDC) and QX71

○: Compatible, △: Partial change required, ×: Incompatible

Specification		AX81-S1	QX71	Compat- ibility	Precautions for replacement
Number of input points		32 points	32 points	○	
Insulation method		Photocoupler	Photocoupler	○	
Rated input voltage		12VDC/24VDC	5VDC/12VDC	○	
Rated input current		2.5mA/5mA	5VDC Approx. 1.2mA 12VDC Approx. 3.3mA	○	
Operating voltage range		10.2 to 26.4VDC (Ripple ratio within 5%)	4.5 to 6VDC (Ripple ratio within 5%) 10.2 to 14.4VDC (Ripple ratio within 5%)	○	
Maximum number of simultaneous input points		60% (5 point/common) Simultaneously ON	100% Simultaneously ON	○	
ON voltage/ON current		5.6VDC or more/1.1mA or more	3.5VDC or more/1mA or more	△	The ON voltage/ON current are different.*1
OFF voltage/OFF current		2.4VDC or less/0.39mA or less	1VDC or less/0.1mA or less	△	The OFF voltage/OFF current are different.*1
Input resistance		Approx. 4.8kΩ	Approx. 3.3kΩ	△	Input resistance has reduced.*1
Response time	OFF to ON	10ms or less	1ms/5ms/10ms/20ms/70ms or less (CPU parameter setting) Initial setting is 10ms	○	Use initial value (10ms) for the input response time of parameters.
	ON to OFF	10ms or less	1ms/5ms/10ms/20ms/70ms or less (CPU parameter setting) Initial setting is 10ms	○	
Common terminal arrangement		8 points/common (Common terminal: TB9, TB18, TB27, TB36)	32 points/common (Common terminal: B01, B02)	△	As the common changes from four commons to a common, wiring with a different voltage for each common is not possible.
Operation indication		ON indication (LED)	ON indication (LED)	○	
External connection method		38-point terminal block connector (M3 × 6 screws)	40 pin connector (Option)	×	Wiring change is required.*2
Applicable wire size		0.75 to 2mm ²	0.3mm ² (For A6CON1 or A6CON4)	×	
Applicable solderless terminal		R1.25-3, R2-3, RAV1.25-3, RAV2-3	—	×	
Current consumption		0.105A (TYP. all points ON)	0.07A (TYP. all points ON)	○	
External dimensions		250 (H) × 37.5 (W) × 131 (D) mm	98 (H) × 27.4 (W) × 90 (D) mm	△	
Weight		0.45kg	0.12kg	△	

*1 Check the specifications of the sensor or switches to be connected to the QX71.

*2 By using the conversion module such as the FA-TB32XY, conversion to the terminal block is possible.

(62) Specifications comparison between AX81-S2 (when using 48VDC) and QX50

○: Compatible, △: Partial change required, ×: Incompatible

Specification		AX81-S2	QX50	Compat- ibility	Precautions for replacement
Number of input points		32 points	16 points	△	Use two QX50s when using 17 points or more.
Insulation method		Photocoupler	Photocoupler	○	
Rated input voltage		48VDC/60VDC	48VDC/48VAC	○	
Rated input current		3mA/4mA	Approx. 4mA	○	
Operating voltage range		41 to 66VDC (Ripple ratio within 5%)	40.8 to 57.6VDC (Ripple ratio within 5%) 40.8 to 52.8VAC (Ripple ratio within 5%)	○	
Maximum number of simultaneous input points		60% (5 point/common) Simultaneously ON	Refer to the derating chart. *2	○	
ON voltage/ON current		31VDC or more/1.7mA or more	28VDC or more/2.5mA or more	△	The ON voltage/ON current are different. *1
OFF voltage/OFF current		10VDC or less/0.5mA or less	10VDC or less/1mA or less	△	The OFF current is different. *1
Input resistance		Approx. 18kΩ	Approx. 11.2kΩ	△	Input resistance has reduced. *1
Response time	OFF to ON	20ms or less (60VDC)	1ms/5ms/10ms/20ms/70ms or less (CPU parameter setting) Initial setting is 10ms	○	Set the input response time of parameters to 20ms.
	ON to OFF	20ms or less (60VDC)	1ms/5ms/10ms/20ms/70ms or less (CPU parameter setting) Initial setting is 10ms	○	
Common terminal arrangement		8 points/common (Common terminal: TB9, TB18, TB27, TB36)	16 points/common (Common terminal: TB17)	△	As the common changes from four commons to a common, wiring with a different voltage for each common is not possible.
Operation indication		ON indication (LED)	ON indication (LED)	○	
External connection method		38-point terminal block connector (M3 × 6 screws)	18-point terminal block (M3 × 6 screws)	×	Wiring change is required.
Applicable wire size		0.75 to 2mm ²	0.3 to 0.75mm ² core (Outside diameter: 2.8mm or less.)	×	
Applicable solderless terminal		R1.25-3, R2-3, RAV1.25-3, RAV2-3	R1.25-3 (Sleeved solderless terminals cannot be used.)	×	
Current consumption		0.110A (TYP. all points ON)	0.05A (TYP. all points ON)	○	
External dimensions		250 (H) × 37.5 (W) × 131 (D) mm	98 (H) × 27.4 (W) × 90 (D) mm	△	
Weight		0.45kg	0.16kg	△	

*1 Check the specifications of the sensor or switches to be connected to the QX50.

*2 The following shows the derating chart.

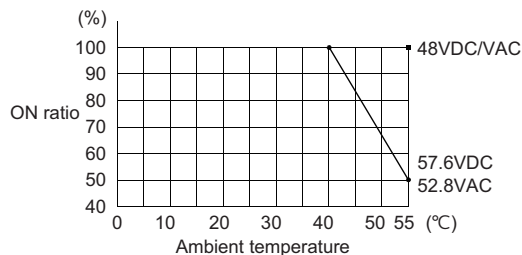

(63) Specifications comparison between AX81-S2 (when using 60VDC) and QX81

○: Compatible, △: Partial change required, ×: Incompatible

Specification		AX81-S2	QX81	Compat- ibility	Precautions for replacement
Number of input points		32 points	32 points	○	
Insulation method		Photocoupler	Photocoupler	○	
Rated input voltage		48VDC/60VDC	24VDC	×	Connect the 8.2kΩ (1W or more) resistor serially to the external signal wire.
Rated input current		3mA/4mA	Approx. 4mA	○	
Operating voltage range		41 to 66VDC (Ripple ratio within 5%)	20.4 to 28.8VDC (Ripple ratio within 5%)	×	Connect the 8.2kΩ (1W or more) resistor serially to the external signal wire.
Maximum number of simultaneous input points		60% (5 point/common) Simultaneously ON	Refer to the derating chart.*1	○	
ON voltage/ON current		31VDC or more/1.7mA or more	19VDC or more/3mA or more	×	The ON voltage/ON current are different.
OFF voltage/OFF current		10VDC or less/0.5mA or less	11VDC or less/1.7mA or less	×	The OFF voltage/OFF current are different.
Input resistance		Approx. 18kΩ	Approx. 5.6kΩ	△	Input resistance has reduced.
Response time	OFF to ON	20ms or less (60VDC)	1ms/5ms/10ms/20ms/70ms or less (CPU parameter setting) Initial setting is 10ms	○	Set the input response time of parameters to 20ms.
	ON to OFF	20ms or less (60VDC)	1ms/5ms/10ms/20ms/70ms or less (CPU parameter setting) Initial setting is 10ms	○	
Common terminal arrangement		8 points/common (Common terminal: TB9, TB18, TB27, TB36)	32 points/common (Common terminal: 17, 18, 36)	△	As the common changes from four commons to a common, wiring with a different voltage for each common is not possible.
Operation indication		ON indication (LED)	ON indication (LED)	○	
External connection method		38-point terminal block connector (M3 × 6 screws)	37 pin D-sub connector (Option)	×	Wiring change is required.*2
Applicable wire size		0.75 to 2mm ²	0.3mm ² (For A6CON1E)	×	
Applicable solderless terminal		R1.25-3, R2-3, RAV1.25-3, RAV2-3	-	×	
Current consumption		0.110A (TYP. all points ON)	0.075A (TYP. all points ON)	○	
External dimensions		250 (H) × 37.5 (W) × 131 (D) mm	98 (H) × 27.4 (W) × 90 (D) mm	△	
Weight		0.45kg	0.16kg	△	

*1 The following shows the derating chart.

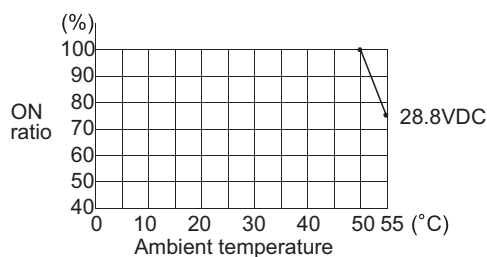

*2 By using connectors/terminal block converter modules such as the A6TBXY36-E and the conversion module such as the FA-TB32XY, conversion to the terminal block is possible.

(64) Specifications comparison between AX81-S3 (when using 24VDC) and QX82-S1

○: Compatible, △: Partial change required, ×: Incompatible

Specification		AX81-S3	QX82-S1	Compat- ibility	Precautions for replacement
Number of input points		32 points	64 points	△	Set 32 points in the I/O assignment of Parameter.
Insulation method		Photocoupler	Photocoupler	○	
Rated input voltage		12VDC/24VDC	24VDC	○	
Rated input current		4mA/10mA	Approx. 4mA	△	Reduced.*1
Operating voltage range		10.2 to 26.4VDC (Ripple ratio within 5%)	20.4 to 28.8VDC (Ripple ratio within 5%)	○	
Maximum number of simultaneous input points		60% (5 point/common) Simultaneously ON	Refer to the derating chart. *2	△	Use within the range shown in the derating figure.
ON voltage/ON current		9.5VDC or more/3mA or more	19VDC or more/3mA or more	△	The ON voltage is different.*1
OFF voltage/OFF current		6VDC or less/1.5mA or less	9.5VDC or less/1.5mA or less	△	The OFF voltage is different.*1
Input resistance		Approx. 2.4kΩ	Approx. 5.6kΩ	△	Input resistance has increased.*1
Response time	OFF to ON	0.1ms or less	0.1ms/0.2ms/0.4ms/0.6ms /1ms or less (CPU parameter setting) Initial setting is 0.2ms	○	Set the input response time of parameters to 0.1ms.
	ON to OFF	0.2ms or less	0.1ms/0.2ms/0.4ms/0.6ms /1ms or less (CPU parameter setting) Initial setting is 0.2ms	○	
Common terminal arrangement		8 points/common (Common terminal: TB9, TB18, TB27, TB36)	32 points/common (Common terminal: 1B01, 1B02, 2B01, 2B02)	△	As the common changes from four commons to a common, wiring with a different voltage for each common is not possible.
Operation indication		ON indication (LED)	ON indication (LED) 32 point switch-over using switch	○	
External connection method		38-point terminal block connector (M3 × 6 screws)	40 pin connector × 1 (Option)	×	Wiring change is required.
Applicable wire size		0.75 to 2mm ²	0.3mm ² (For A6CON1 or A6CON4)	×	
Applicable solderless terminal		R1.25-3, R2-3, RAV1.25-3, RAV2-3	-	×	
Current consumption		0.110A (TYP. all points ON)	0.09A (TYP. all points ON)	○	
External dimensions		250 (H) × 37.5 (W) × 131 (D) mm	98 (H) × 27.4 (W) × 90 (D) mm	△	
Weight		0.45kg	0.18kg	△	

*1 Check the specifications of the sensor or switches to be connected to the QX82-S1.

*2 The following shows the derating chart.

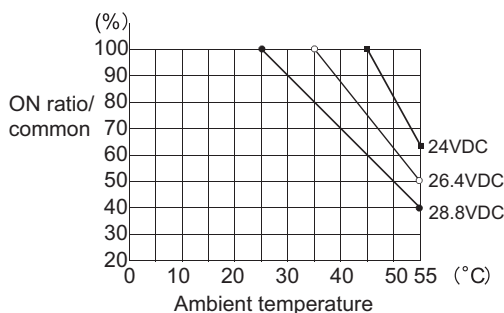

(65) Specifications comparison between AX81-S3 (when using 12VDC) and QX71

○: Compatible, △: Partial change required, ×: Incompatible

Specification		AX81-S3	QX71	Compat- ibility	Precautions for replacement
Number of input points		32 points	32 points	○	
Insulation method		Photocoupler	Photocoupler	○	
Rated input voltage		12VDC/24VDC	5VDC/12VDC	○	
Rated input current		4mA/10mA	5VDC Approx. 1.2mA 12VDC Approx. 3.3mA	△	Reduced.*1
Operating voltage range		10.2 to 26.4VDC (Ripple ratio within 5%)	4.5 to 6VDC (Ripple ratio within 5%) 10.2 to 14.4VDC (Ripple ratio within 5%)	○	
Maximum number of simultaneous input points		60% (5 point/common) Simultaneously ON	100% Simultaneously ON	△	
ON voltage/ON current		9.5VDC or more/3mA or more	3.5VDC or more/1mA or more	△	The ON voltage/ON current are different.*1
OFF voltage/OFF current		6VDC or less/1.5mA or less	1VDC or less/0.1mA or less	△	The OFF voltage/OFF current are different.*1
Input resistance		Approx. 2.4kΩ	Approx. 3.3kΩ	△	Input resistance has increased.*1
Response time	OFF to ON	0.1ms or less	1ms/5ms/10ms/20ms/70ms or less (CPU parameter setting) Initial setting is 10ms	△	Response time differs. Set the time depending on control targets.
	ON to OFF	0.2ms or less	1ms/5ms/10ms/20ms/70ms or less (CPU parameter setting) Initial setting is 10ms	△	
Common terminal arrangement		8 points/common (Common terminal: TB9, TB18, TB27, TB36)	32 points/common (Common terminal: B01, B02)	△	As the common changes from four commons to a common, wiring with a different voltage for each common is not possible.
Operation indication		ON indication (LED)	ON indication (LED) 32 point switch-over using switch	○	
External connection method		38-point terminal block connector (M3 × 6 screws)	40 pin connector (Option)	×	Wiring change is required.
Applicable wire size		0.75 to 2mm ²	0.3mm ² (For A6CON1 or A6CON4)	×	
Applicable solderless terminal		R1.25-3, R2-3, RAV1.25-3, RAV2-3	—	×	
Current consumption		0.110A (TYP. all points ON)	0.070A (TYP. all points ON)	○	
External dimensions		250 (H) × 37.5 (W) × 131 (D) mm	98 (H) × 27.4 (W) × 90 (D) mm	△	
Weight		0.45kg	0.12kg	△	

*1 Check the specifications of the sensor or switches to be connected to the QX71.

(66) Specifications comparison between AX82 (when using 24VDC) and QX82

○: Compatible, △: Partial change required, ×: Incompatible

Specification		AX82	QX82	Compat- ibility	Precautions for replacement
Number of input points		64 points	64 points	○	
Insulation method		Photocoupler	Photocoupler	○	
Rated input voltage		12VDC/24VDC	24VDC	○	
Rated input current		Approx. 3mA/Approx. 7mA	Approx. 4mA	△	Reduced.*1
Operating voltage range		10.2 to 26.4VDC (Ripple ratio within 5%)	20.4 to 28.8VDC (Ripple ratio within 5%)	○	
Maximum number of simultaneous input points		40points (When located next to the power supply module : 26points)	Refer to the derating chart.*2	△	Use within the range shown in the derating figure.
ON voltage/ON current		9.5VDC or more/2.6mA or more	19VDC or more/3mA or more	△	The ON voltage/ON current are different.*1
OFF voltage/OFF current		6VDC or less/1.0mA or less	11VDC or less/1.7mA or less	△	The OFF voltage/OFF current are different.*1
Input resistance		Approx. 3.4kΩ	Approx. 5.6kΩ	△	Input resistance has increased.*1
Response time	OFF to ON	10ms or less	1ms/5ms/10ms/20ms/70ms or less (CPU parameter setting) Initial setting is 10ms	○	Use initial value (10ms) for the input response time of parameters.
	ON to OFF	10ms or less	1ms/5ms/10ms/20ms/70ms or less (CPU parameter setting) Initial setting is 10ms	○	
Common terminal arrangement		32 points/common (Common terminal: 1-17, 1-18, 1-36, 2-17, 2-18, 2-36)	32 points/common (Common terminal: 1B01, 1B02, 2B01, 2B02)	○	
Operation indication		ON indication (LED) 32 point switch-over using switch	ON indication (LED) 32 point switch-over using switch	○	
External connection method		37 pin D-sub connector (Soldered) × 2	40 pin connector × 2 (Option)	×	Connector change is required.
Applicable wire size		0.3mm ²	0.3mm ² (For A6CON1 or A6CON4)	○	
Current consumption		0.12A (TYP. all points ON)	0.090A (TYP. all points ON)	○	
External dimensions		250 (H) × 37.5 (W) × 106 (D) mm	98 (H) × 27.4 (W) × 90 (D) mm	△	
Weight		0.60kg	0.18kg	△	

*1 Check the specifications of the sensor or switches to be connected to the QX82.

*2 The following shows the derating chart.

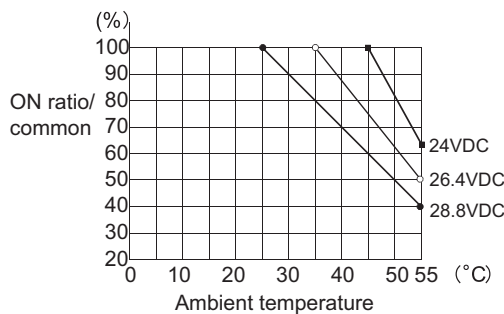

(67) Specifications comparison between AX82 (when using 24VDC) and QX81-S2

○: Compatible, △: Partial change required, ×: Incompatible

Specification		AX82	QX81-S2	Compat- ibility	Precautions for replacement
Number of input points		64 points	32 points	△	Use two QX81-S2s when using 33 points or more.
Insulation method		Photocoupler	Photocoupler	○	
Rated input voltage		12VDC/24VDC	24VDC	○	
Rated input current		Approx. 3mA/Approx. 7mA	Approx. 6mA	△	Rated input current has decreased.*1
Operating voltage range		10.2 to 26.4VDC (Ripple ratio within 5%)	20.4 to 28.8VDC (Ripple ratio within 5%)	○	
Maximum number of simultaneous input points		40points (When located next to the power supply module : 26points)	Refer to the derating chart.*2	○	Use within the range shown in the derating figure.
ON voltage/ON current		9.5VDC or more/2.6mA or more	15VDC or more/3mA or more	△	The ON voltage/ON current are different.*1
OFF voltage/OFF current		6VDC or less/1.0mA or less	5VDC or less/1.7mA or less	△	The OFF voltage/OFF current are different.*1
Input resistance		Approx. 3.4kΩ	Approx. 3.6kΩ	△	Input resistance has increased.*1
Response time	OFF to ON	10ms or less	1ms/5ms/10ms/20ms/70ms or less (CPU parameter setting) Initial setting is 10ms	○	Use initial value (10ms) for the input response time of parameters.
	ON to OFF	10ms or less	1ms/5ms/10ms/20ms/70ms or less (CPU parameter setting) Initial setting is 10ms	○	
Common terminal arrangement		32 points/common (Common terminal: 1-17, 1-18, 1-36, 2-17, 2-18, 2-36)	32 points/common (Common terminal: 17, 18, 36)	○	
Operation indication		ON indication (LED) 32 point switch-over using switch	ON indication (LED)	○	
External connection method		37 pin D-sub connector (Soldered) × 2	37 pin D-sub connector (Option)	△	When the connector included in the AX82 is used, replace it with the connector shell of the A6CON1E (sold separately).
Applicable wire size		0.3mm ²	0.3mm ² (For A6CON1E)	○	
Current consumption		0.12A (TYP. all points ON)	0.075A (TYP. all points ON)	○	
External dimensions		250 (H) × 37.5 (W) × 106 (D) mm	98 (H) × 27.4 (W) × 90 (D) mm	△	
Weight		0.60kg	0.16kg	△	

*1 Check the specifications of the sensor or switches to be connected to the QX81-S2.

*2 The following shows the derating chart.

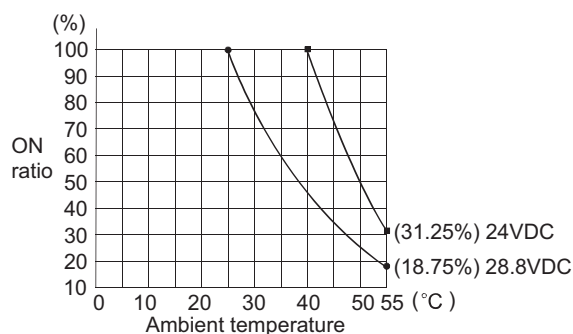

(68) Specifications comparison between AX82 (when using 12VDC) and QX72

○: Compatible, △: Partial change required, ×: Incompatible

Specification		AX82	QX72	Compat- ibility	Precautions for replacement
Number of input points		64 points	64 points	○	
Insulation method		Photocoupler	Photocoupler	○	
Rated input voltage		12VDC/24VDC	5VDC/12VDC	○	
Rated input current		Approx. 3mA/Approx. 7mA	5VDC Approx. 1.2mA 12VDC Approx. 3.3mA	○	
Operating voltage range		10.2 to 26.4VDC (Ripple ratio within 5%)	4.5 to 6VDC (Ripple ratio within 5%) 10.2 to 14.4VDC (Ripple ratio within 5%)	○	
Maximum number of simultaneous input points		40 points (When located next to the power supply module : 26 points)	100% Simultaneously ON	○	
ON voltage/ON current		9.5VDC or more/3mA or more	3.5VDC or more/1mA or more	△	The ON voltage/ON current are different.*1
OFF voltage/OFF current		6VDC or less/1.0mA or less	1VDC or less/0.1mA or less	△	The OFF voltage/OFF current are different.*1
Input resistance		Approx. 3.4kΩ	Approx. 3.3kΩ	○	
Response time	OFF to ON	10ms or less	1ms/5ms/10ms/20ms/70ms or less (CPU parameter setting) Initial setting is 10ms	○	Use initial value (10ms) for the input response time of parameters.
	ON to OFF	10ms or less	1ms/5ms/10ms/20ms/70ms or less (CPU parameter setting) Initial setting is 10ms	○	
Common terminal arrangement		32 points/common (Common terminal: 1-17, 1-18, 1-36, 2-17, 2-18, 2-36)	32 points/common (Common terminal: 1B01, 1B02, 2B01, 2B02)	○	
Operation indication		ON indication (LED) 32 point switch-over using switch	ON indication (LED) 32 point switch-over using switch	○	
External connection method		37 pin D-sub connector (Soldered) × 2	40 pin connector × 2 (Option)	×	The connector change is required.
Applicable wire size		0.3mm ²	0.3mm ² (For A6CON1 or A6CON4)	○	
Current consumption		0.12A (TYP. all points ON)	0.085A (TYP. all points ON)	○	
External dimensions		250 (H) × 37.5 (W) × 106 (D) mm	98 (H) × 27.4 (W) × 90 (D) mm	△	
Weight		0.60kg	0.13kg	△	

*1 Check the specifications of the sensor or switches to be connected to the QX81-S2.

3.2.2 Output module specifications comparison

(1) Specifications comparison between AY10 and QY10

○: Compatible, △: Partial change required, ×: Incompatible

Specification		AY10	QY10	Compat- ibility	Precautions for replacement
Number of output points		16 points	16 points	○	
Insulation method		Photocoupler	Relay	△	Insulation method is different, but the performance is equivalent.
Rated switching voltage/current		24VDC 2A (Resistive load)/point 240VAC 2A (COSφ=1)/point 8A/common	24VDC 2A (Resistive load)/point 240VAC 2A (COSφ=1)/point 8A/common	○	
Minimum switching load		5VDC 1mA	5VDC 1mA	○	
Maximum switching voltage		264VAC 125VDC	264VAC 125VDC	○	
Leakage current at OFF		—	—		
Response time	OFF to ON	10ms or less	10ms or less	○	
	ON to OFF	12ms or less	12ms or less	○	
Life	Mechanical	20 million times or more	20 million times or more	○	
	Electrical	Rated switching voltage/current load 200 thousand times or more	Rated switching voltage/current load 100 thousand times or more	△	Replace the module more frequently since the life is approximately half.
		200VAC 1.5A, 240VAC 1A (COSφ=0.7) 200 thousand times or more 200VAC 0.7A, 240VAC 0.5A (COSφ=0.35) 200 thousand times or more 24VDC 1A, 100VDC 0.1A (L/R=7ms) 200 thousand times or more	200VAC 1.5A, 240VAC 1A (COSφ=0.7) 100 thousand times or more 200VAC 0.4A, 240VAC 0.3A (COSφ=0.7) 300 thousand times or more 200VAC 1A, 240VAC 0.5A (COSφ=0.35) 100 thousand times or more 200VAC 0.3A, 240VAC 0.15A (COSφ=0.35) 300 thousand times or more 24VDC 1A, 100VDC 0.1A (L/R=7ms) 100 thousand times or more 24VDC 0.3A, 100VDC 0.03A (L/R=7ms) 300 thousand times or more	△	
Maximum switching frequency	3600 times/hour	3600 times/hour	○		
Common terminal arrangement		8 points/common (Common terminal: TB9, TB18)	16 points/common (Common terminal: TB17)	△	As the common changes from two commons to a common, wiring with a different voltage for each common is not possible.
Operation indication		ON indication (LED)	ON indication (LED)	○	
External power supply	Voltage	24VDC ±10% Ripple voltage 4Vp-p or less	—	○	External power supply is not required.
	Current	150mA (24VDC TYP. all points ON)	—	○	
External connection method		20-point terminal block connector (M3 × 6 screws)	18-point terminal block (M3 × 6 screws)	×	Wiring change is required.*1
Applicable wire size		0.75 to 2mm ²	0.3 to 0.75mm ² core (Outside diameter: 2.8mm or less)	×	
Applicable solderless terminal		R1.25-3, R2-3, RAV1.25-3, RAV2-3	R1.25-3 (Sleeved solderless terminals cannot be used.)	×	
Current consumption		0.115A (TYP. all points ON)	0.43A (TYP. all points ON)	△	Review current capacity since current consumption is increased.
External dimensions		250 (H) × 37.5 (W) × 121 (D) mm	98 (H) × 27.4 (W) × 90 (D) mm	△	Wiring space is narrow.
Weight		0.44kg	0.22kg	△	

*1 The wiring change is not required by using the conversion adapter (ERNT-AQTY10) manufactured by Mitsubishi Electric Engineering Co., Ltd.

(2) Specifications comparison between AY10A and QY18A

○: Compatible, △: Partial change required, ×: Incompatible

Specification		AY10A	QY18A	Compat- ibility	Precautions for replacement
Number of output points		16 points	8 points (16 points occupied)	△	Use two QY18As when using 9 points or more.
Insulation method		Photocoupler	Relay	△	Insulation method is different, but the performance is equivalent.
Rated switching voltage/current		24VDC 2A (Resistive load)/point 240VAC 2A (COSφ=1)/point 16A/all points	24VDC 2A (Resistive load)/point 240VAC 2A (COSφ=1)/point 8A/all points	○	
Minimum switching load		5VDC 1mA	5VDC 1mA	○	
Maximum switching voltage		264VAC 125VDC	264VAC 125VDC	○	
Response time	OFF to ON	10ms or less	10ms or less	○	
	ON to OFF	12ms or less	12ms or less	○	
Life	Mechanical	20 million times or more	20 million times or more	○	
	Electrical	Rated switching voltage/current load 200 thousand times or more	Rated switching voltage/current load 100 thousand times or more	△	Replace the module more frequently since the life is approximately half.
		200VAC 1.5A, 240VAC 1A (COSφ=0.7) 200 thousand times or more 200VAC 0.7A, 240VAC 0.5A (COSφ=0.35) 200 thousand times or more 24VDC 1A, 100VDC 0.1A (L/R=7ms) 200 thousand times or more	200VAC 1.5A, 240VAC 1A (COSφ=0.7) 100 thousand times or more 200VAC 0.4A, 240VAC 0.3A (COSφ=0.7) 300 thousand times or more 200VAC 1A, 240VAC 0.5A (COSφ=0.35) 100 thousand times or more 200VAC 0.3A, 240VAC 0.15A (COSφ=0.35) 300 thousand times or more 24VDC 1A, 100VDC 0.1A (L/R=7ms) 100 thousand times or more 24VDC 0.3A, 100VDC 0.03A (L/R=7ms) 300 thousand times or more	△	
Maximum switching frequency	3600 times/hour	3600 times/hour	○		
Common terminal arrangement		Not provided (All points independent)	Not provided (All points independent)	○	
Operation indication		ON indication (LED)	ON indication (LED)	○	
External power supply	Voltage	24VDC ±10% Ripple voltage 4Vp-p or less	—	○	External power supply is not required.
	Current	150mA (24VDC TYP. all points ON)	—	○	
External connection method		38-point terminal block connector (M3 × 6 screws)	18-point terminal block (M3 × 6 screws)	×	Wiring change is required.
Applicable wire size		0.75 to 2mm ²	0.3 to 0.75mm ² core (Outside diameter: 2.8mm or less)	×	
Applicable solderless terminal		R1.25-3, R2-3, RAV1.25-3, RAV2-3	R1.25-3 (Sleeved solderless terminals cannot be used.)	×	
Current consumption		0.115A (TYP. all points ON)	0.24A (TYP. all points ON)	△	Review current capacity since current consumption is increased.
External dimensions		250 (H) × 37.5 (W) × 131 (D) mm	98 (H) × 27.4 (W) × 90 (D) mm	△	Wiring space is narrow.
Weight		0.50kg	0.22kg	△	

(3) Specifications comparison between AY10A-UL and QY18A

○: Compatible, △: Partial change required, ×: Incompatible

Specification		AY10A-UL	QY18A	Compat- ibility	Precautions for replacement
Number of output points		16 points	8 points (16 points occupied)	△	Use two QY18As when using 9 points or more.
Insulation method		Photocoupler	Relay	△	Insulation method is different, but the performance is equivalent.
Rated switching voltage/current		24VDC 2A (Resistive load)/point 240VAC 2A (COSφ=1)/point 16A/all points	24VDC 2A (Resistive load)/point 240VAC 2A (COSφ=1)/point 8A/all points	○	
Minimum switching load		5VDC 1mA	5VDC 1mA	○	
Maximum switching voltage		264VAC 125VDC	264VAC 125VDC	○	
Response time	OFF to ON	10ms or less	10ms or less	○	
	ON to OFF	12ms or less	12ms or less	○	
Life	Mechanical	20 million times or more	20 million times or more	○	
	Electrical	Rated switching voltage/current load 200 thousand times or more	Rated switching voltage/current load 100 thousand times or more	△	Replace the module more frequently since the life is approximately half.
		200VAC 1.5A, 240VAC 1A (COSφ=0.7) 200 thousand times or more 200VAC 0.75A, 240VAC 0.5A (COSφ=0.35) 200 thousand times or more 24VDC 1A, 100VDC 0.1A (L/R=7ms) 200 thousand times or more	200VAC 1.5A, 240VAC 1A (COSφ=0.7) 100 thousand times or more 200VAC 0.4A, 240VAC 0.3A (COSφ=0.7) 300 thousand times or more 200VAC 1A, 240VAC 0.5A (COSφ=0.35) 100 thousand times or more 200VAC 0.3A, 240VAC 0.15A (COSφ=0.35) 300 thousand times or more 24VDC 1A, 100VDC 0.1A (L/R=7ms) 100 thousand times or more 24VDC 0.3A, 100VDC 0.03A (L/R=7ms) 300 thousand times or more	△	
Maximum switching frequency	3600 times/hour	3600 times/hour	○		
Common terminal arrangement		Not provided (All points independent)	Not provided (All points independent)	○	
Operation indication		ON indication (LED)	ON indication (LED)	○	
External power supply	Voltage	24VDC ±10% Ripple voltage 4Vp-p or less	—	○	External power supply is not required.
	Current	150mA (24VDC TYP. all points ON)	—	○	
External connection method		38-point terminal block connector (M3.5 × 7 screws)	18-point terminal block (M3 × 6 screws)	×	Wiring change is required.
Applicable wire size		18 AWG to 14 AWG (0.75 to 2mm ²)	0.3 to 0.75mm ² core (Outside diameter: 2.8mm or less)	×	
Applicable solderless terminal		RAV1.25-3.5, RAV2-3.5	R1.25-3 (Sleeved solderless terminals cannot be used.)	×	
Current consumption		0.115A (TYP. all points ON)	0.24A (TYP. all points ON)	△	Review current capacity since current consumption is increased.
Dielectric withstand voltage (Across external circuit and internal circuit)		Between AC external terminals and ground, 1500VAC rms, 1 minute	2830VAC rms/3cycles (Altitude 2,000m)	○	
Insulation resistance		5MΩ or more by insulation resistance tester	10MΩ or more by insulation resistance tester	○	

Specification	AY10A-UL	QY18A	Compat- ibility	Precautions for replacement
Noise durability	By noise simulator of 1500Vp-p noise voltage, 1μs noise width and 25 to 60Hz noise frequency	By noise simulator of 1500Vp-p noise voltage, 1μs noise width and 25 to 60Hz noise frequency First transient noise IEC61000-4-4: 1kV	○	
External dimensions	250 (H) × 37.5 (W) × 131 (D) mm	98 (H) × 27.4 (W) × 90 (D) mm	△	Wiring space is narrow.
Weight	0.50kg	0.22kg	△	

(4) Specifications comparison between AY11 and QY10

○: Compatible, △: Partial change required, ×: Incompatible

Specification		AY11	QY10	Compat- ibility	Precautions for replacement
Number of output points		16 points	16 points	○	
Insulation method		Photocoupler	Relay	△	Insulation method is different, but the performance is equivalent.
Rated switching voltage/current		24VDC 2A (Resistive load)/point 240VAC 2A (COSφ=1)/point 8A/common	24VDC 2A (Resistive load)/point 240VAC 2A (COSφ=1)/point 8A/common	○	
Minimum switching load		5VDC 1mA	5VDC 1mA	○	
Maximum switching voltage		264VAC 125VDC	264VAC 125VDC	○	
Leakage current at OFF		0.1mA (200VAC, 60Hz)	–	○	
Response time	OFF to ON	10ms or less	10ms or less	○	
	ON to OFF	12ms or less	12ms or less	○	
Life	Mechanical	20 million times or more	20 million times or more	○	
	Electrical	Rated switching voltage/current load 200 thousand times or more	Rated switching voltage/current load 100 thousand times or more	△	Replace the module more frequently since the life is approximately half.
		200VAC 1.5A, 240VAC 1A (COSφ=0.7) 200 thousand times or more 200VAC 0.7A, 240VAC 0.5A (COSφ=0.35) 200 thousand times or more 24VDC 1A, 100VDC 0.1A (L/R=7ms) 200 thousand times or more	200VAC 1.5A, 240VAC 1A (COSφ=0.7) 100 thousand times or more 200VAC 0.4A, 240VAC 0.3A (COSφ=0.7) 300 thousand times or more 200VAC 1A, 240VAC 0.5A (COSφ=0.35) 100 thousand times or more 200VAC 0.3A, 240VAC 0.15A (COSφ=0.35) 300 thousand times or more 24VDC 1A, 100VDC 0.1A (L/R=7ms) 100 thousand times or more 24VDC 0.3A, 100VDC 0.03A (L/R=7ms) 300 thousand times or more	△	
Maximum switching frequency	3600 times/hour	3600 times/hour	○		
Surge suppressor		Varistor (387 to 473V)	None	×	Varistors are not built in.*1
Relay socket		Yes	None	×	Replace the module itself when its relay has a failure.
Common terminal arrangement		8 points/common (Common terminal: TB9, TB18)	16 points/common (Common terminal: TB17)	△	It is not applicable to use a different voltage for each eight points since the QY10 has only one common.
Operation indication		ON indication (LED)	ON indication (LED)	○	
External power supply	Voltage	24VDC ±10% Ripple voltage 4Vp-p or less	–	○	External power supply is not required.
	Current	150mA (24VDC TYP. all points ON)	–	○	
External connection method		20-point terminal block connector (M3 × 6 screws)	18-point terminal block (M3 × 6 screws)	×	Wiring change is required.*2
Applicable wire size		0.75 to 2mm ²	0.3 to 0.75mm ² core (Outside diameter: 2.8mm or less)	×	
Applicable solderless terminal		R1.25-3, R2-3, RAV1.25-3, RAV2-3	R1.25-3 (Sleeved solderless terminals cannot be used.)	×	
Current consumption		0.115A (TYP. all points ON)	0.43A (TYP. all points ON)	△	Review current capacity since current consumption is increased.
External dimensions		250 (H) × 37.5 (W) × 121 (D) mm	98 (H) × 27.4 (W) × 90 (D) mm	△	Wiring space is narrow.
Weight		0.50kg	0.22kg	△	

*1 Connect a varistor to reduce external noise.

*2 The wiring change is not required by using the conversion adapter (ERNT-AQTY10) manufactured by Mitsubishi Electric Engineering Co., Ltd.

(5) Specifications comparison between AY11A and QY18A

○: Compatible, △: Partial change required, ×: Incompatible

Specification		AY11A	QY18A	Compat- ibility	Precautions for replacement
Number of output points		16 points	8 points (16 points occupied)	△	Use two QY18As when using 9 points or more.
Insulation method		Photocoupler	Relay	△	Insulation method is different, but the performance is equivalent.
Rated switching voltage/current		24VDC 2A (Resistive load)/point 240VAC 2A (COSφ=1)/point 16A/all points	24VDC 2A (Resistive load)/point 240VAC 2A (COSφ=1)/point 8A/all points	○	
Minimum switching load		5VDC 1mA	5VDC 1mA	○	
Maximum switching voltage		264VAC 125VDC	264VAC 125VDC	○	
Leakage current at OFF		0.1mA (200VAC, 60Hz)	—	○	
Response time	OFF to ON	10ms or less	10ms or less	○	
	ON to OFF	12ms or less	12ms or less	○	
Life	Mechanical	20 million times or more	20 million times or more	○	
	Electrical	Rated switching voltage/current load 200 thousand times or more	Rated switching voltage/current load 100 thousand times or more	△	Replace the module more frequently since the life is approximately half.
		200VAC 1.5A, 240VAC 1A (COSφ=0.7) 200 thousand times or more 200VAC 0.7A, 240VAC 0.5A (COSφ=0.35) 200 thousand times or more 24VDC 1A, 100VDC 0.1A (L/R=7ms) 200 thousand times or more	200VAC 1.5A, 240VAC 1A (COSφ=0.7) 100 thousand times or more 200VAC 0.4A, 240VAC 0.3A (COSφ=0.7) 300 thousand times or more 200VAC 1A, 240VAC 0.5A (COSφ=0.35) 100 thousand times or more 200VAC 0.3A, 240VAC 0.15A (COSφ=0.35) 300 thousand times or more 24VDC 1A, 100VDC 0.1A (L/R=7ms) 100 thousand times or more 24VDC 0.3A, 100VDC 0.03A (L/R=7ms) 300 thousand times or more	△	
Maximum switching frequency	3600 times/hour	3600 times/hour	○		
Surge suppressor		Varistor (387 to 473V)	None	×	Varistors are not built in.*1
Common terminal arrangement		Not provided (All points independent)	Not provided (All points independent)	○	
Operation indication		ON indication (LED)	ON indication (LED)	○	
External power supply	Voltage	24VDC ±10% Ripple voltage 4Vp-p or less	—	○	External power supply is not required.
	Current	150mA (24VDC TYP. all points ON)	—	○	
External connection method		38-point terminal block connector (M3 × 6 screws)	18-point terminal block (M3 × 6 screws)	×	Wiring change is required.
Applicable wire size		0.75 to 2mm ²	0.3 to 0.75mm ² core (Outside diameter: 2.8mm or less)	×	
Applicable solderless terminal		R1.25-3, R2-3, RAV1.25-3, RAV2-3	R1.25-3 (Sleeved solderless terminals cannot be used.)	×	
Current consumption		0.115A (TYP. all points ON)	0.24A (TYP. all points ON)	△	Review current capacity since current consumption is increased.
External dimensions		250 (H) × 37.5 (W) × 131 (D) mm	98 (H) × 27.4 (W) × 90 (D) mm	△	Wiring space is narrow.
Weight		0.47kg	0.22kg	△	

*1 Connect a varistor to reduce external noise.

(6) Specifications comparison between AY11AEU and QY18A

○: Compatible, △: Partial change required, ×: Incompatible

Specification		AY11AEU	QY18A	Compat- ibility	Precautions for replacement
Number of output points		16 points	8 points (16 points occupied)	△	Use two QY18As when using 9 points or more.
Insulation method		Photocoupler	Relay	△	Insulation method is different, but the performance is equivalent.
Rated switching voltage/current		24VDC 2A (Resistive load)/point 24VAC 2A (COSφ=1)/point 16A/all points	24VDC 2A (Resistive load)/point 240VAC 2A (COSφ=1)/point 8A/all points	○	
Minimum switching load		5VDC 1mA	5VDC 1mA	○	
Maximum switching voltage		49.9VAC 74.9VDC	264VAC 125VDC	○	
Leakage current at OFF		0.1mA (49.9VAC, 60Hz)	—	○	
Response time	OFF to ON	10ms or less	10ms or less	○	
	ON to OFF	12ms or less	12ms or less	○	
Life	Mechanical	20 million times or more	20 million times or more	○	
	Electrical	Rated switching voltage/current load 200 thousand times or more	Rated switching voltage/current load 100 thousand times or more	△	Replace the module more frequently since the life is approximately half.
		24VAC 1.5A (COSφ=0.7) 200 thousand times or more 24VAC 0.75A (COSφ=0.35) 200 thousand times or more 24VDC 1A, 48VDC 0.1A (L/R=7ms) 200 thousand times or more	200VAC 1.5A, 240VAC 1A (COSφ=0.7) 100 thousand times or more 200VAC 0.4A, 240VAC 0.3A (COSφ=0.7) 300 thousand times or more 200VAC 1A, 240VAC 0.5A (COSφ=0.35) 100 thousand times or more 200VAC 0.3A, 240VAC 0.15A (COSφ=0.35) 300 thousand times or more 24VDC 1A, 100VDC 0.1A (L/R=7ms) 100 thousand times or more 24VDC 0.3A, 100VDC 0.03A (L/R=7ms) 300 thousand times or more	△	
Maximum switching frequency	3600 times/hour	3600 times/hour	○		
Surge suppressor		Varistor (387 to 473V)	None	×	Varistors are not built in.*1
Common terminal arrangement		Not provided (All points independent)	Not provided (All points independent)	○	
Operation indication		ON indication (LED)	ON indication (LED)	○	
External power supply	Voltage	24VDC ±10% Ripple voltage 4Vp-p or less	—	○	External power supply is not required.
	Current	150mA (24VDC TYP. all points ON)	—	○	
External connection method		38-point terminal block connector (M3 × 6 screws)	18-point terminal block (M3 × 6 screws)	×	Wiring change is required.
Applicable wire size		0.75 to 2mm ²	0.3 to 0.75mm ² core (Outside diameter: 2.8mm or less)	×	
Applicable solderless terminal		R1.25-3, R2-3, RAV1.25-3, RAV2-3	R1.25-3 (Sleeved solderless terminals cannot be used.)	×	
Current consumption		0.115A (TYP. all points ON)	0.24A (TYP. all points ON)	△	Review current capacity since current consumption is increased.
Dielectric withstand voltage (Across external circuit and internal circuit)		Between AC external terminals and ground, 1500VAC rms, 1 minute Between DC external terminals and ground, 500VAC rms, 1 minute	2830VAC rms/3cycles (Altitude 2,000m)	○	
Insulation resistance		Between AC/DC external terminals and ground, 500VDC 10MΩ or more by insulation resistance tester	10MΩ or more by insulation resistance tester	○	

Specification	AY11AEU	QY18A	Compat- ibility	Precautions for replacement
Noise durability	By noise simulator of 1500Vp-p AC type noise voltage and 500Vp-p DC type noise voltage, 1μs noise width and 25 to 60Hz noise frequency	By noise simulator of 1500Vp-p noise voltage, 1μs noise width and 25 to 60Hz noise frequency First transient noise IEC61000-4-4: 1kV	○	
External dimensions	250 (H) × 37.5 (W) × 131 (D) mm	98 (H) × 27.4 (W) × 90 (D) mm	△	Wiring space is narrow.
Weight	0.47kg	0.22kg	△	

*1 Connect a varistor to reduce external noise.

(7) Specifications comparison between AY11E and QY10

○: Compatible, △: Partial change required, ×: Incompatible

Specification		AY11E	QY10	Compat- ibility	Precautions for replacement
Number of output points		16 points	16 points	○	
Insulation method		Photocoupler	Relay	△	Insulation method is different, but the performance is equivalent.
Rated switching voltage/current		24VDC 2A (Resistive load)/point 240VAC 2A (COSφ=1)/point 8A/common	24VDC 2A (Resistive load)/point 240VAC 2A (COSφ=1)/point 8A/common	○	
Minimum switching load		5VDC 1mA	5VDC 1mA	○	
Maximum switching voltage		250VAC 125VDC	264VAC 125VDC	○	
Leakage current at OFF		0.1mA (200VAC, 60Hz)	—	○	
Response time	OFF to ON	10ms or less	10ms or less	○	
	ON to OFF	12ms or less	12ms or less	○	
Life	Mechanical	20 million times or more	20 million times or more	○	
	Electrical	Rated switching voltage/current load 200 thousand times or more	Rated switching voltage/current load 100 thousand times or more	△	Replace the module more frequently since the life is approximately half.
		200VAC 1.5A, 240VAC 1A (COSφ=0.7) 200 thousand times or more 200VAC 0.7A, 240VAC 0.5A (COSφ=0.35) 200 thousand times or more 24VDC 1A, 100VDC 0.1A (L/R=7ms) 200 thousand times or more	200VAC 1.5A, 240VAC 1A (COSφ=0.7) 100 thousand times or more 200VAC 0.4A, 240VAC 0.3A (COSφ=0.7) 300 thousand times or more 200VAC 1A, 240VAC 0.5A (COSφ=0.35) 100 thousand times or more 200VAC 0.3A, 240VAC 0.15A (COSφ=0.35) 300 thousand times or more 24VDC 1A, 100VDC 0.1A (L/R=7ms) 100 thousand times or more 24VDC 0.3A, 100VDC 0.03A (L/R=7ms) 300 thousand times or more	△	
Maximum switching frequency	3600 times/hour	3600 times/hour	○		
Surge suppressor		Varistor (387 to 473V)	None	×	Varistors are not built in.*1
Common terminal arrangement		8 points/common (Common terminal: TB9, TB18)	16 points/common (Common terminal: TB17)	△	As the common changes from two commons to a common, wiring with a different voltage for each common is not possible.
Operation indication		ON indication (LED)	ON indication (LED)	○	
Fuse		8A MF51NM8 or FGMA250V8A	None	×	Fuses are not built in.*2
Fuse blow indicator		None	—	○	
External power supply	Voltage	24VDC ±10% Ripple voltage 4Vp-p or less	—	○	External power supply is not required.
	Current	150mA (24VDC TYP. all points ON)	—	○	
External connection method		20-point terminal block connector (M3 × 6 screws)	18-point terminal block (M3 × 6 screws)	×	Wiring change is required.*3
Applicable wire size		0.75 to 2mm ²	0.3 to 0.75mm ² core (Outside diameter: 2.8mm or less)	×	
Applicable solderless terminal		R1.25-3, R2-3, RAV1.25-3, RAV2-3	R1.25-3 (Sleeved solderless terminals cannot be used.)	×	
Current consumption		0.115A (TYP. all points ON)	0.43A (TYP. all points ON)	△	Review current capacity since current consumption is increased.
External dimensions		250 (H) × 37.5 (W) × 121 (D) mm	98 (H) × 27.4 (W) × 90 (D) mm	△	Wiring space is narrow.
Weight		0.47kg	0.22kg	△	

*1 Connect a varistor to reduce external noise.

*2 Mount a fuse on every external terminal to prevent external devices and modules from burning out upon load short circuit.

*3 The wiring change is not required by using the conversion adapter (ERNT-AQTY10) manufactured by Mitsubishi Electric Engineering Co., Ltd.

(8) Specifications comparison between AY11EEU and QY10

○: Compatible, △: Partial change required, ×: Incompatible

Specification		AY11EEU	QY10	Compat- ibility	Precautions for replacement
Number of output points		16 points	16 points	○	
Insulation method		Photocoupler	Relay	△	Insulation method is different, but the performance is equivalent.
Rated switching voltage/current		24VDC 2A (Resistive load)/point 24VAC 2A (COSφ=1)/point 8A/common	24VDC 2A (Resistive load)/point 240VAC 2A (COSφ=1)/point 8A/common	○	
Minimum switching load		5VDC 1mA	5VDC 1mA	○	
Maximum switching voltage		49.9VAC 74.9VDC	264VAC 125VDC	○	
Leakage current at OFF		0.1mA (49.9VAC, 60Hz)	—	○	
Response time	OFF to ON	10ms or less	10ms or less	○	
	ON to OFF	12ms or less	12ms or less	○	
Life	Mechanical	20 million times or more	20 million times or more	○	
	Electrical	Rated switching voltage/current load 200 thousand times or more	Rated switching voltage/current load 100 thousand times or more	△	Replace the module more frequently since the life is approximately half.
		24VAC 1.5A (COSφ=0.7) 200 thousand times or more 24VAC 0.75A (COSφ=0.35) 200 thousand times or more 24VDC 1A, 48VDC 0.1A (L/R=7ms) 200 thousand times or more	200VAC 1.5A, 240VAC 1A (COSφ=0.7) 100 thousand times or more 200VAC 0.4A, 240VAC 0.3A (COSφ=0.7) 300 thousand times or more 200VAC 1A, 240VAC 0.5A (COSφ=0.35) 100 thousand times or more 200VAC 0.3A, 240VAC 0.15A (COSφ=0.35) 300 thousand times or more 24VDC 1A, 100VDC 0.1A (L/R=7ms) 100 thousand times or more 24VDC 0.3A, 100VDC 0.03A (L/R=7ms) 300 thousand times or more	△	
Maximum switching frequency	3600 times/hour	3600 times/hour	○		
Surge suppressor		Varistor (387 to 473V)	None	×	Varistors are not built in.*1
Common terminal arrangement		8 points/common (Common terminal: TB9, TB18)	16 points/common (Common terminal: TB17)	△	As the common changes from two commons to a common, wiring with a different voltage for each common is not possible.
Operation indication		ON indication (LED)	ON indication (LED)	○	
Fuse		8A MF51NM8 or FGMA250V 8A	None	×	Fuses are not built in.*2
Fuse blow indicator		None	—	○	
External power supply	Voltage	24VDC ±10% Ripple voltage 4Vp-p or less	—	○	External power supply is not required.
	Current	150mA (24VDC TYP. all points ON)	—	○	
External connection method		20-point terminal block connector (M3 × 6 screws)	18-point terminal block (M3 × 6 screws)	×	Wiring change is required.*3
Applicable wire size		0.75 to 2mm ²	0.3 to 0.75mm ² core (Outside diameter: 2.8mm or less)	×	
Applicable solderless terminal		R1.25-3, R2-3, RAV1.25-3, RAV2-3	R1.25-3 (Sleeved solderless terminals cannot be used.)	×	
Current consumption		0.115A (TYP. all points ON)	0.43A (TYP. all points ON)	△	Review current capacity since current consumption is increased.
Dielectric withstand voltage (Across external circuit and internal circuit)		Between AC external terminals and ground, 1500VAC rms, 1 minute Between DC external terminals and ground, 500VAC rms, 1 minute	2830VAC rms/3cycles (Altitude 2,000m)	○	

Specification	AY11EEU	QY10	Compat- ibility	Precautions for replacement
Insulation resistance	Between AC/DC external terminals and ground, 500VDC 10MΩ or more by insulation resistance tester	10MΩ or more by insulation resistance tester	○	
Noise durability	By noise simulator of 1500Vp-p AC type noise voltage and 500Vp-p DC type noise voltage, 1μs noise width and 25 to 60Hz noise frequency	By noise simulator of 1500Vp-p noise voltage, 1μs noise width and 25 to 60Hz noise frequency First transient noise IEC61000-4-4: 1kV	○	
External dimensions	250 (D) × 37.5 (W) × 121 (D) mm	98 (H) × 27.4 (W) × 90 (D) mm	△	Wiring space is narrow.
Weight	0.47kg	0.22kg	△	

*1 Connect a varistor to reduce external noise.

*2 Mount a fuse on every external terminal to prevent external devices and modules from burning out upon load short circuit.

*3 The wiring change is not required by using the conversion adapter (ERNT-AQTY10) manufactured by Mitsubishi Electric Engineering Co., Ltd.

(9) Specifications comparison between AY11-UL and QY10

○: Compatible, △: Partial change required, ×: Incompatible

Specification		AY11-UL	QY10	Compat- ibility	Precautions for replacement
Number of output points		16 points	16 points	○	
Insulation method		Photocoupler	Relay	△	Insulation method is different, but the performance is equivalent.
Rated switching voltage/current		24VDC 2A (Resistive load)/point 240VAC 2A (COSφ=1)/point 8A/common	24VDC 2A (Resistive load)/point 240VAC 2A (COSφ=1)/point 8A/common	○	
Minimum switching load		5VDC 1mA	5VDC 1mA	○	
Maximum switching voltage		264VAC 125VDC	264VAC 125VDC	○	
Leakage current at OFF		0.1mA (200VAC, 60Hz)	—	○	
Response time	OFF to ON	10ms or less	10ms or less	○	
	ON to OFF	12ms or less	12ms or less	○	
Life	Mechanical	20 million times or more	20 million times or more	○	
	Electrical	Rated switching voltage/current load 200 thousand times or more	Rated switching voltage/current load 100 thousand times or more	△	Replace the module more frequently since the life is approximately half.
		200VAC 1.5A, 240VAC 1A (COSφ=0.7) 200 thousand times or more 200VAC 0.7A, 240VAC 0.5A (COSφ=0.35) 200 thousand times or more 24VDC 1A, 100VDC 0.1A (L/R=7ms) 200 thousand times or more	200VAC 1.5A, 240VAC 1A (COSφ=0.7) 100 thousand times or more 200VAC 0.4A, 240VAC 0.3A (COSφ=0.7) 300 thousand times or more 200VAC 1A, 240VAC 0.5A (COSφ=0.35) 100 thousand times or more 200VAC 0.3A, 240VAC 0.15A (COSφ=0.35) 300 thousand times or more 24VDC 1A, 100VDC 0.1A (L/R=7ms) 100 thousand times or more 24VDC 0.3A, 100VDC 0.03A (L/R=7ms) 300 thousand times or more	△	
Maximum switching frequency	3600 times/hour	3600 times/hour	○		
Common terminal arrangement		8 points/common (Common terminal: TB9, TB18)	16 points/common (Common terminal: TB17)	△	As the common changes from two commons to a common, wiring with a different voltage for each common is not possible.
Operation indication		ON indication (LED)	ON indication (LED)	○	
Surge suppressor		Varistor (387 to 473V)	None	×	Varistors are not built in. ^{*1}
Relay socket		Yes	None	×	Replace the module itself when its relay has a failure.
External power supply	Voltage	24VDC ±10% Ripple voltage 4Vp-p or less	—	○	External power supply is not required.
	Current	150mA (24VDC TYP. all points ON)	—	○	
External connection method		20-point terminal block connector (M3.5 × 7 screws)	18-point terminal block (M3 × 6 screws)	×	Wiring change is required. ^{*2}
Applicable wire size		18 AWG to 14 AWG (0.75 to 2mm ²)	0.3 to 0.75mm ² core (Outside diameter: 2.8mm or less)	×	
Applicable solderless terminal		RAV1.25-3.5, RAV2-3.5	R1.25-3 (Sleeved solderless terminals cannot be used.)	×	
Current consumption		0.12A (TYP. all points ON)	0.43A (TYP. all points ON)	△	Review current capacity since current consumption is increased.
Dielectric withstand voltage (Across external circuit and internal circuit)		Between AC external terminals and ground, 1500VAC rms, 1 minute	2830VAC rms/3cycles (Altitude 2,000m)	○	
Insulation resistance		5MΩ or more by insulation resistance tester	10MΩ or more by insulation resistance tester	○	

Specification	AY11-UL	QY10	Compat- ibility	Precautions for replacement
Noise durability	By noise simulator of 1500Vp-p noise voltage, 1μs noise width and 25 to 60Hz noise frequency	By noise simulator of 1500Vp-p noise voltage, 1μs noise width and 25 to 60Hz noise frequency First transient noise IEC61000-4-4: 1kV	○	
External dimensions	250 (H) × 37.5 (W) × 121 (D) mm	98 (H) × 27.4 (W) × 90 (D) mm	△	Wiring space is narrow.
Weight	0.50kg	0.22kg	△	

*1 Connect a varistor to reduce external noise.

*2 The wiring change is not required by using the conversion adapter (ERNT-AQTY10) manufactured by Mitsubishi Electric Engineering Co., Ltd.

(10) Specifications comparison between AY13 and QY10

○: Compatible, △: Partial change required, ×: Incompatible

Specification		AY13	QY10	Compat- ibility	Precautions for replacement
Number of output points		32 points	16 points	△	Use two QY10s when using 17 points or more.
Insulation method		Photocoupler	Relay	△	Insulation method is different, but the performance is equivalent.
Rated switching voltage/current		24VDC 2A (Resistive load)/point 240VAC 2A (COSφ=1)/point 5A/common	24VDC 2A (Resistive load)/point 240VAC 2A (COSφ=1)/point 8A/common	○	
Minimum switching load		5VDC 1mA	5VDC 1mA	○	
Maximum switching voltage		264VAC 125VDC	264VAC 125VDC	○	
Response time	OFF to ON	10ms or less	10ms or less	○	
	ON to OFF	12ms or less	12ms or less	○	
Life	Mechanical	20 million times or more	20 million times or more	○	
	Electrical	Rated switching voltage/current load 200 thousand times or more	Rated switching voltage/current load 100 thousand times or more	△	Replace the module more frequently since the life is approximately half.
		200VAC 1.5A, 240VAC 1A (COSφ=0.7) 200 thousand times or more 200VAC 0.7A, 240VAC 0.5A (COSφ=0.35) 200 thousand times or more 24VDC 1A, 100VDC 0.1A (L/R=7ms) 200 thousand times or more	200VAC 1.5A, 240VAC 1A (COSφ=0.7) 100 thousand times or more 200VAC 0.4A, 240VAC 0.3A (COSφ=0.7) 300 thousand times or more 200VAC 1A, 240VAC 0.5A (COSφ=0.35) 100 thousand times or more 200VAC 0.3A, 240VAC 0.15A (COSφ=0.35) 300 thousand times or more 24VDC 1A, 100VDC 0.1A (L/R=7ms) 100 thousand times or more 24VDC 0.3A, 100VDC 0.03A (L/R=7ms) 300 thousand times or more	△	
Maximum switching frequency	3600 times/hour	3600 times/hour	○		
Common terminal arrangement		8 points/common (Common terminal: TB9, TB18, TB27, TB36)	16 points/common (Common terminal: TB17)	△	As the common changes from two commons to a common, wiring with a different voltage for each common is not possible.
Operation indication		ON indication (LED)	ON indication (LED)	○	
External power supply	Voltage	24VDC ±10% Ripple voltage 4Vp-p or less	—	○	External power supply is not required.
	Current	290mA (24VDC TYP. all points ON)	—	○	
External connection method		38-point terminal block connector (M3 × 6 screws)	18-point terminal block (M3 × 6 screws)	×	Wiring change is required.
Applicable wire size		0.75 to 2mm ²	0.3 to 0.75mm ² core (Outside diameter: 2.8mm or less)	×	
Applicable solderless terminal		R1.25-3, R2-3, RAV1.25-3, RAV2-3	R1.25-3 (Sleeved solderless terminals cannot be used.)	×	
Current consumption		0.23A (TYP. all points ON)	0.43A (TYP. all points ON)	△	Review current capacity since current consumption is increased.
External dimensions		250 (H) × 37.5 (W) × 131 (D) mm	98 (H) × 27.4 (W) × 90 (D) mm	△	Wiring space is narrow.
Weight		0.59kg	0.22kg	△	

(11) Specifications comparison between AY13E and QY10

○: Compatible, △: Partial change required, ×: Incompatible

Specification		AY13E	QY10	Compat- ibility	Precautions for replacement
Number of output points		32 points	16 points	△	Use two QY10s when using 17 points or more.
Insulation method		Photocoupler	Relay	△	Insulation method is different, but the performance is equivalent.
Rated switching voltage/current		24VDC 2A (Resistive load)/point 240VAC 2A (COS ϕ =1)/point 5A/common	24VDC 2A (Resistive load)/point 240VAC 2A (COS ϕ =1)/point 8A/common	○	
Minimum switching load		5VDC 1mA	5VDC 1mA	○	
Maximum switching voltage		250VAC 125VDC	264VAC 125VDC	○	
Response time	OFF to ON	10ms or less	10ms or less	○	
	ON to OFF	12ms or less	12ms or less	○	
Life	Mechanical	20 million times or more	20 million times or more	○	
	Electrical	Rated switching voltage/current load 200 thousand times or more	Rated switching voltage/current load 100 thousand times or more	△	Replace the module more frequently since the life is approximately half.
		200VAC 1.5A, 240VAC 1A (COS ϕ =0.7) 200 thousand times or more 200VAC 0.7A, 240VAC 0.5A (COS ϕ =0.35) 200 thousand times or more 24VDC 1A, 100VDC 0.1A (L/R=7ms) 200 thousand times or more	200VAC 1.5A, 240VAC 1A (COS ϕ =0.7) 100 thousand times or more 200VAC 0.4A, 240VAC 0.3A (COS ϕ =0.7) 300 thousand times or more 200VAC 1A, 240VAC 0.5A (COS ϕ =0.35) 100 thousand times or more 200VAC 0.3A, 240VAC 0.15A (COS ϕ =0.35) 300 thousand times or more 24VDC 1A, 100VDC 0.1A (L/R=7ms) 100 thousand times or more 24VDC 0.3A, 100VDC 0.03A (L/R=7ms) 300 thousand times or more	△	
Maximum switching frequency	3600 times/hour	3600 times/hour	○		
Surge suppressor		None	None	○	
Common terminal arrangement		8 points/common (Common terminal: TB9, TB18, TB27, TB36)	16 points/common (Common terminal: TB17)	△	As the common changes from two commons to a common, wiring with a different voltage for each common is not possible.
Operation indication		ON indication (LED)	ON indication (LED)	○	
Fuse		8A MF51NM8 or FGMA250V8A	None	×	Fuses are not built in.*1
Fuse blow indicator		None	–	○	
External power supply	Voltage	24VDC \pm 10% Ripple voltage 4Vp-p or less	–	○	External power supply is not required.
	Current	290mA (24VDC TYP. all points ON)	–	○	
External connection method		38-point terminal block connector (M3 \times 6 screws)	18-point terminal block (M3 \times 6 screws)	×	Wiring change is required.
Applicable wire size		0.75 to 2mm ²	0.3 to 0.75mm ² core (Outside diameter: 2.8mm or less)	×	
Applicable solderless terminal		R1.25-3, R2-3, RAV1.25-3, RAV2-3	R1.25-3 (Sleeved solderless terminals cannot be used.)	×	
Current consumption		0.23A (TYP. all points ON)	0.43A (TYP. all points ON)	△	Review current capacity since current consumption is increased.
External dimensions		250 (H) \times 37.5 (W) \times 131 (D) mm	98 (H) \times 27.4 (W) \times 90 (D)mm	△	Wiring space is narrow.
Weight		0.60kg	0.22kg	△	

*1 Mount a fuse on every external terminal to prevent external devices and modules from burning out upon load short circuit.

(12) Specifications comparison between AY13EU and QY10

○: Compatible, △: Partial change required, ×: Incompatible

Specification		AY13EU	QY10	Compat- ibility	Precautions for replacement
Number of output points		32 points	16 points	△	Use two QY10s when using 17 points or more.
Insulation method		Photocoupler	Relay	△	Insulation method is different, but the performance is equivalent.
Rated switching voltage/current		24VDC 2A (Resistive load)/point 24VAC 2A (COSφ=1)/point 5A/common	24VDC 2A (Resistive load)/point 240VAC 2A (COSφ=1)/point 8A/common	○	
Minimum switching load		5VDC 1mA	5VDC 1mA	○	
Maximum switching voltage		49.9VAC 74.9VDC	264VAC 125VDC	○	
Leakage current at OFF		—	—	—	
Response time	OFF to ON	10ms or less	10ms or less	○	
	ON to OFF	12ms or less	12ms or less	○	
Life	Mechanical	20 million times or more	20 million times or more	○	
	Electrical	Rated switching voltage/current load 200 thousand times or more	Rated switching voltage/current load 100 thousand times or more	△	Replace the module more frequently since the life is approximately half.
		24VAC 1.5A (COSφ=0.7) 200 thousand times or more 24VAC 0.75A (COSφ=0.35) 200 thousand times or more 24VDC 1A, 48VDC 0.1A (L/R=7ms) 200 thousand times or more	200VAC 1.5A, 240VAC 1A (COSφ=0.7) 100 thousand times or more 200VAC 0.4A, 240VAC 0.3A (COSφ=0.7) 300 thousand times or more 200VAC 1A, 240VAC 0.5A (COSφ=0.35) 100 thousand times or more 200VAC 0.3A, 240VAC 0.15A (COSφ=0.35) 300 thousand times or more 24VDC 1A, 100VDC 0.1A (L/R=7ms) 100 thousand times or more 24VDC 0.3A, 100VDC 0.03A (L/R=7ms) 300 thousand times or more	△	
Maximum switching frequency	3600 times/hour	3600 times/hour	○		
Common terminal arrangement		8 points/common (Common terminal: TB9, TB18, TB27, TB36)	16 points/common (Common terminal: TB17)	△	As the common changes from two commons to a common, wiring with a different voltage for each common is not possible.
Operation indication		ON indication (LED)	ON indication (LED)	○	
External power supply	Voltage	24VDC ±10% Ripple voltage 4Vp-p or less	—	○	External power supply is not required.
	Current	290mA (24VDC TYP. all points ON)	—	○	
External connection method		38-point terminal block connector (M3 × 6 screws)	18-point terminal block (M3 × 6 screws)	×	Wiring change is required.
Applicable wire size		0.75 to 2mm ²	0.3 to 0.75mm ² core (Outside diameter: 2.8mm or less)	×	
Applicable solderless terminal		R1.25-3, R2-3, RAV1.25-3, RAV2-3	R1.25-3 (Sleeved solderless terminals cannot be used.)	×	
Current consumption		0.23A (TYP. all points ON)	0.43A (TYP. all points ON)	△	Review current capacity since current consumption is increased.
Dielectric withstand voltage (Across external circuit and internal circuit)		Between AC external terminals and ground, 1500VAC rms, 1 minute Between DC external terminals and ground, 500VAC rms, 1 minute	2830VAC rms/3cycles (Altitude 2,000m)	○	

Specification	AY13EU	QY10	Compat- ibility	Precautions for replacement
Insulation resistance	Between AC/DC external terminals and ground, 500VDC 10MΩ or more by insulation resistance tester	10MΩ or more by insulation resistance tester	○	
Noise durability	By noise simulator of 1500Vp-p AC type noise voltage and 500Vp-p DC type noise voltage, 1μs noise width and 25 to 60Hz noise frequency	By noise simulator of 1500Vp-p noise voltage, 1μs noise width and 25 to 60Hz noise frequency	○	
		First transient noise IEC61000-4-4: 1kV		
External dimensions	250 (H) × 37.5 (W) × 131 (D) mm	98 (H) × 27.4 (W) × 90 (D) mm	△	Wiring space is narrow.
Weight	0.59kg	0.22kg	△	

(13) Specifications comparison between AY15EU and QY10

○: Compatible, △: Partial change required, ×: Incompatible

Specification		AY15EU	QY10	Compat- ibility	Precautions for replacement
Number of output points		24 points (32 points occupied)	16 points	△	Use two QY10s when using 17 points or more.
Insulation method		Photocoupler	Relay	△	Insulation method is different, but the performance is equivalent.
Rated switching voltage/current		24VDC 2A (Resistive load)/point 240VAC 2A (COSφ=1)/point 8A/common	24VDC 2A (Resistive load)/point 240VAC 2A (COSφ=1)/point 8A/common	○	
Minimum switching load		5VDC 10mA	5VDC 1mA	○	
Maximum switching voltage		264VAC 125VDC	264VAC 125VDC	○	
Leakage current at OFF		—	—	—	
Response time	OFF to ON	10ms or less	10ms or less	○	
	ON to OFF	12ms or less	12ms or less	○	
Life	Mechanical	20 million times or more	20 million times or more	○	
	Electrical	Rated switching voltage/current load 200 thousand times or more	Rated switching voltage/current load 100 thousand times or more	△	Replace the module more frequently since the life is approximately half.
		200VAC 2A, 240VAC 1.8A (COSφ=0.7) 200 thousand times or more 200VAC 1.1A, 240VAC 0.9A (COSφ=0.35) 200 thousand times or more 24VDC 1.1A, 100VDC 0.1A (L/R=7ms) 200 thousand times or more	200VAC 1.5A, 240VAC 1A (COSφ=0.7) 100 thousand times or more 200VAC 0.4A, 240VAC 0.3A (COSφ=0.7) 300 thousand times or more 200VAC 1A, 240VAC 0.5A (COSφ=0.35) 100 thousand times or more 200VAC 0.3A, 240VAC 0.15A (COSφ=0.35) 300 thousand times or more 24VDC 1A, 100VDC 0.1A (L/R=7ms) 100 thousand times or more 24VDC 0.3A, 100VDC 0.03A (L/R=7ms) 300 thousand times or more	△	
Maximum switching frequency	3600 times/hour	3600 times/hour	○		
Surge suppressor		None	None	○	
Common terminal arrangement		8 points/common (Common terminal: TB9, TB20, TB31)	16 points/common (Common terminal: TB17)	△	As the common changes from two commons to a common, wiring with a different voltage for each common is not possible.
Operation indication		ON indication (LED)	ON indication (LED)	○	
External power supply	Voltage	24VDC ±10% Ripple voltage 4Vp-p or less (Must be SELV power supply)	—	○	External power supply is not required.
	Current	220mA (24VDC TYP. all points ON) (Must be SELV power supply)	—	○	
External connection method		38-point terminal block connector (M3 × 6 screws)	18-point terminal block (M3 × 6 screws)	×	Wiring change is required.
Applicable wire size		0.75 to 2mm ² (AWG14 to AWG19)	0.3 to 0.75mm ² core (Outside diameter: 2.8mm or less)	×	
Applicable solderless terminal		RAV1.25-3.5, RAV2-3.5	R1.25-3 (Sleeved solderless terminals cannot be used.)	×	

Specification	AY15EU	QY10	Compat- ibility	Precautions for replacement
Dielectric withstand voltage	(AC external batch relay-drive power supply. 5V internal circuit) 2830VAC rms/3 cycle (2,000m (6557,38ft)) (Relay-drive power supply, 5V internal circuit) 500VAC rms/3 cycle (2,000m (6557,38ft))	2830VAC rms/3 cycle (altitude 2,000m (6557,38ft))	○	
Insulation resistance	10MΩ or more by insulation resistance tester	10MΩ or more by insulation resistance tester	○	
Noise durability	IEC801-4 : 1kV	By noise simulator of 1500Vp-p noise voltage, 1μs noise width and 25 to 60Hz noise frequency First transient noise IEC61000-4-4: 1kV	○	
Current consumption	0.15A (TYP. all points ON)	0.43A (TYP. all points ON)	△	Review current capacity since current consumption is increased.
External dimensions	250 (H) × 37.5 (W) × 131 (D) mm	98 (H) × 27.4 (W) × 90 (D) mm	△	Wiring space is narrow.
Weight	0.50kg	0.22kg	△	

(14) Specifications comparison between AY20EU and QY22*1

○: Compatible, △: Partial change required, ×: Incompatible

Specification		AY20EU	QY22	Compat- ibility	Precautions for replacement
Number of output points		16 points	16 points	○	
Insulation method		Photocoupler	Photocoupler	○	
Rated load voltage		100-240VAC 40/70Hz	100-240VAC 50/60Hz ±5%	△	Rated frequency range is different.
Maximum load voltage		264VAC	264VAC	○	
Maximum load current		0.6A/point, 1.9A/common	0.6A/point, 4.8A/common	△	Total common current is reduced.
Minimum load voltage current		24VAC 15mA 120VAC 15mA 240VAC 15mA	24VAC 100mA 100VAC 25mA 240VAC 25mA	△	Minimum load current is increased.
Maximum inrush current		30A 10ms or less 15A 100ms or less	20A 1 cycle or less	△	Reduced
Leakage current (OFF)		1.5mA (240VAC 60Hz)	1.5mA or less (For 120VAC 60Hz) 3mA or less (For 240VAC 60Hz)	△	Increased
Maximum voltage drop at ON		1.5VAC or less (15mA to 0.6A)	1.5V or less	○	
Response time	OFF to ON	1ms or less	1ms + 0.5 cycles or less	○	
	ON to OFF	1ms + 0.5 cycles or less	1ms + 0.5 cycles or less (Rated load, resistance load)	○	
Surge suppressor		CR absorber (0.1μF+47Ω)	CR absorber	○	
Common terminal arrangement		4 points/common (Common terminal : TB8, TB18, TB28, TB38)	16 points/common (Common terminal : TB17)	△	As the common changes from four commons to a common, wiring with a different voltage for each common is not possible.
Operation indication		ON indication (LED)	ON indication (LED)	○	
Fuse		3.2A fuse (1 fuse/common) type GP-32	None (Installing a fuse to an external cable is recommended.)	×	Fuses are not built in.*2
Fuse blow indicator		Yes (LED is turned ON when fuse is blown. Signal is output to a CPU module.)	—	×	
External connection method		38-point terminal block connector (M3.5 × 6 screws)	18-point terminal block (M3 × 6 screws)	×	Wiring change is required.
Applicable wire size		0.75 to 2mm ² (19 AWG to 14 AWG)	0.3 to 0.75mm ² core (Outside diameter: 2.8mm or less)	×	
Applicable solderless terminal		RAV1.25-3.5, RAV2-3.5	R1.25-3 (Sleeved solderless terminals cannot be used.)	×	
Current consumption		0.4A (TYP. all points ON)	0.25A (Max. all points ON)	○	
Dielectric withstand voltage (Across external circuit and internal circuit)		2830VAC rms/3cycles (Altitude 2,000m)	2830VAC rms/3cycles (Altitude 2,000m)	○	
Insulation resistance		10MΩ or more by insulation resistance tester	10MΩ or more by insulation resistance tester	○	
Noise durability		IEC801-4: 1kV	By noise simulator of 1500Vp-p noise voltage, 1μs noise width and 25 to 60Hz noise frequency First transient noise IEC61000-4-4: 1kV	○	
External dimensions		250 (H) × 37.5 (W) × 131 (D) mm	98 (H) × 27.4 (W) × 112 (D) mm	△	Wiring space is narrow.
Weight		0.65kg	0.40kg	△	

*1 Consider the characteristics of the triac and observe the necessary precautions by referring to Section 3.3 (4) before replacing the modules.

*2 Mount a fuse on every external terminal to prevent the external device and module deterioration upon load short circuit. Also, configure an external circuit when displaying fuse blown is required.

(15) Specifications comparison between AY22 and QY22*1

○: Compatible, △: Partial change required, ×: Incompatible

Specification		AY22	QY22	Compat- ibility	Precautions for replacement
Number of output points		16 points	16 points	○	
Insulation method		Photocoupler	Photocoupler	○	
Rated load voltage		100-240VAC 50/60Hz ±5%	100-240VAC 50/60Hz ±5%	○	
Maximum load voltage		264VAC	264VAC	○	
Maximum load current		2A/point, 3.3A/common	0.6A/point, 4.8A/common	△	Carefully select load for use since the maximum load current per point is lowered.
Minimum load voltage current		24VAC 100mA 100VAC 10mA 240VAC 20mA	24VAC 100mA 100VAC 25mA 240VAC 25mA	△	Carefully select load for use since the minimum load current is increased.
Maximum inrush current		40A 10ms or less 15A 100ms or less	20A 1 cycle or less	△	Carefully select load for use since the inrush current value differs.
Leakage current (OFF)		1.5mA (120VAC 60Hz) 3mA (240VAC 60Hz)	1.5mA or less (For 120VAC 60Hz) 3mA or less (For 240VAC 60Hz)	○	
Maximum voltage drop at ON		1.5VAC or less (1 to 2A) 1.8VAC or less (0.2 to 1A) 5VAC or less (0.2A or less)	1.5V or less	○	
Response time	OFF to ON	1ms or less	1ms + 0.5 cycles or less	○	
	ON to OFF	1ms + 0.5 cycles or less	1ms + 0.5 cycles or less (Rated load, resistance load)	○	
Surge suppressor		CR absorber (0.022μF+47Ω) Varistor (387 to 473V)	CR absorber	△	Varistors are not built in. *2
Common terminal arrangement		8 points/common (Common terminal : TB9, TB18)	16 points/common (Common terminal : TB17)	△	As the common changes from two commons to a common, wiring with a different voltage for each common is not possible.
Operation indication		ON indication (LED)	ON indication (LED)	○	
Fuse		7A fast blow fuse (1 fuse/common) type HP-70K	None (Installing a fuse to an external cable is recommended.)	×	
Fuse blow indicator		Yes (LED is turned ON when fuse is blown. Signal is output to a programmable controller CPU.)	-	×	Fuses are not built in. *3
External connection method		20-point terminal block connector (M3 × 6 screws)	18-point terminal block (M3 × 6 screws)	×	
Applicable wire size		0.75 to 2mm ²	0.3 to 0.75mm ² core (Outside diameter: 2.8mm or less)	×	Wiring change is required. *4
Applicable solderless terminal		R1.25-3, R2-3, RAV1.25-3, RAV2-3	R1.25-3 (Sleeved solderless terminals cannot be used.)	×	
Current consumption		0.305A (TYP. all points ON)	0.25A (Max. all points ON)	○	
External dimensions		250 (H) × 37.5 (W) × 121 (D) mm	98 (H) × 27.4 (W) × 112 (D) mm	△	Wiring space is narrow.
Weight		0.71kg	0.40kg	△	

*1 Consider the characteristics of the triac and observe the necessary precautions by referring to Section 3.3 (4) before replacing the modules.

*2 Connect a varistor to reduce external noise.

*3 Mount a fuse on every external terminal to prevent the external device and module deterioration upon load short circuit. Also, configure an external circuit when displaying fuse blown is required.

*4 The wiring change is not required by using the conversion adapter (ERNT-AQTY22) manufactured by Mitsubishi Electric Engineering Co., Ltd.

(16) Specifications comparison between AY23 and QY22*1

○: Compatible, △: Partial change required, ×: Incompatible

Specification		AY23	QY22	Compat- ibility	Precautions for replacement
Number of output points		32 points	16 points	△	Use two QY22s when using 17 points or more.
Insulation method		Photocoupler	Photocoupler	○	
Rated load voltage		100-240VAC 40 to 70Hz	100-240VAC 50/60Hz ±5%	○	
Maximum load voltage		264VAC	264VAC	○	
Maximum load current		0.6A/point, 2.4A/common (When placing next to the power supply module: 1.05A/common)	0.6A/point, 4.8A/common	○	
Minimum load voltage current		24VAC 100mA 100VAC 10mA 240VAC 10mA	24VAC 100mA 100VAC 25mA 240VAC 25mA	△	Carefully select load for use since the minimum load current is increased.
Maximum inrush current		20A 10ms or less 8A 100ms or less	20A 1 cycle or less	○	
Leakage current (OFF)		1.5mA (120VAC 60Hz) 3mA (240VAC 60Hz)	1.5mA or less (for 120VAC 60Hz) 3mA or less (for 240VAC 60Hz)	○	
Maximum voltage drop at ON		1.5VAC or less (100 to 600mA) 1.8VAC or less (50 to 100mA) 2VAC or less (10 to 50mA)	1.5V or less	○	
Response time	OFF to ON	1ms or less	1ms + 0.5 cycles or less	○	
	ON to OFF	1ms + 0.5 cycles or less	1ms + 0.5 cycles or less (rated load, resistance load)	○	
Surge suppressor		CR absorber (0.022μF + 47Ω)	CR absorber	○	
Common terminal arrangement		8 points/common (Common terminal : TB9, TB18, TB27, TB36)	16 points/common (Common terminal : TB17)	△	As the common changes from two commons to a common, wiring with a different voltage for each common is not possible.
Operation indication		ON indication (LED)	ON indication (LED)	○	
Fuse		3.2A fast blow fuse (1 fuse/common) type HP-32	None	×	Fuses are not built in. *2
Fuse blow indicator		Yes (LED is turned ON when fuse is blown. Signal is output to a programmable controller CPU.)	-	×	
External connection method		38-point terminal block connector (M3 × 6 screws)	18-point terminal block (M3 × 6 screws)	×	Wiring change is required.
Applicable wire size		0.75 to 2mm ²	0.3 to 0.75mm ² core (Outside diameter: 2.8mm or less)	×	
Applicable solderless terminal		R1.25-3, R2-3, RAV1.25-3, RAV2-3	R1.25-3 (Sleeved solderless terminals cannot be used.)	×	
Current consumption		0.59A (TYP. all points ON)	0.25A (Max. all points ON)	○	
External dimensions		250 (H) × 37.5 (W) × 131 (D) mm	98 (H) × 27.4 (W) × 112.3 (D) mm	△	Wiring space is narrow.
Weight		0.55kg	0.40kg	△	

*1 Consider the characteristics of the triac and observe the necessary precautions by referring to Section 3.3 (4) before replacing the modules.

*2 Mount a fuse on every external terminal to prevent the external device and module deterioration upon load short circuit. Also, configure an external circuit when displaying fuse blown is required.

(17) Specifications comparison between AY40 and QY40P

○: Compatible, △: Partial change required, ×: Incompatible

Specification		AY40	QY40P	Compat- ibility	Precautions for replacement
Number of output points		16 points	16 points	○	
Insulation method		Photocoupler	Photocoupler	○	
Rated load voltage		12/24VDC	12-24VDC	○	
Operating load voltage range		10.2-40VDC	10.2-28.8VDC	△	Voltage over 28.8 VDC is not applicable.
Maximum load current		0.1A/point, 0.8A/common	0.1A/point, 1.6A/common	○	
Maximum inrush current		0.4A	0.7A 10ms or less	○	
Leakage current (OFF)		0.1mA or less	0.1mA or less	○	
Maximum voltage drop at ON		2.5VDC (0.1A) 1.75VDC (5mA) 1.7VDC (1mA)	0.1VDC (TYP.) 0.1A 0.2VDC (Max.) 0.1A	○	
Response time	OFF to ON	2ms or less	1ms or less	○	
	ON to OFF	2ms or less (Resistive load)	1ms or less (Rated load, resistance load)	○	
Surge suppressor		Clamp diode	Zener diode	○	
Common terminal arrangement		8 points/common (Common terminal: TB10, TB20)	16 points/common (Common terminal: TB18)	△	As the common changes from two commons to a common, wiring with a different voltage for each common is not possible.
Operation indication		ON indication (LED)	ON indication (LED)	○	
Protection function		None	Yes (overheat protection function, overload protection function) • Overheat protection function is activated in increments of 1 point. • Overload protection function is activated in increments of 1 point.	○	
External connection method		20-point terminal block connector (M3 × 6 screws)	18-point terminal block (M3 × 6 screws)	×	Wiring change is required.*1
Applicable wire size		0.75 to 2mm ²	0.3 to 0.75mm ² core (Outside diameter: 2.8mm or less)	×	
Applicable solderless terminal		R1.25-3, R2-3, RAV1.25-3, RAV2-3	R1.25-3 (Sleeved solderless terminals cannot be used.)	×	
External power supply	Voltage	12/24VDC (10.2 to 40VDC)	12-24VDC (10.2 to 28.8V) (Ripple ratio within 5%)	△	Voltage over 28.8 VDC is not applicable.
	Current	8mA (24VDC TYP. /common)	10mA (at 24VDC) (Max. all points ON)	○	
Current consumption		0.115A (TYP. all points ON)	0.065A (TYP. all points ON)	○	
External dimensions		250 (H) × 37.5 (W) × 121 (D) mm	98 (H) × 27.4 (W) × 90 (D) mm	△	Wiring space is narrow.
Weight		0.36kg	0.16kg	△	

*1 The wiring change is not required by using the conversion adapter (ERNT-AQTY40) manufactured by Mitsubishi Electric Engineering Co., Ltd.

(18) Specifications comparison between AY40-UL and QY40P

○: Compatible, △: Partial change required, ×: Incompatible

Specification		AY40-UL	QY40P	Compat- ibility	Precautions for replacement
Number of output points		16 points	16 points	○	
Insulation method		Photocoupler	Photocoupler	○	
Rated load voltage		12/24VDC	12-24VDC	○	
Operating load voltage range		10.2-40VDC	10.2-28.8VDC	△	Voltage over 28.8 VDC is not applicable.
Maximum load current		0.1A/point, 0.8A/common	0.1A/point, 1.6A/common	○	
Maximum inrush current		0.4A	0.7A 10ms or less	△	
Leakage current (OFF)		0.1mA or less	0.1mA or less	○	
Maximum voltage drop at ON		2.5VDC (0.1A) 1.75VDC (5mA) 1.7VDC (1mA)	0.1VDC (TYP.) 0.1A 0.2VDC (Max.) 0.1A	○	
Response time	OFF to ON	2ms or less	1ms or less	○	
	ON to OFF	2ms or less (Resistive load)	1ms or less (Rated load, resistance load)	○	
Surge suppressor		Clamp diode	Zener diode	○	
Common terminal arrangement		8 points/common (Common terminal: TB10, TB20)	16 points/common (Common terminal: TB18)	△	As the common changes from two commons to a common, wiring with a different voltage for each common is not possible.
Operation indication		ON indication (LED)	ON indication (LED)	○	
Protection function		None	Yes (overheat protection function, overload protection function) • Overheat protection function is activated in increments of 1 point. • Overload protection function is activated in increments of 1 point.	○	
External connection method		20-point terminal block connector (M3.5 × 7 screws)	18-point terminal block (M3 × 6 screws)	×	Wiring change is required.*1
Applicable wire size		18 AWG to 14 AWG (0.75 to 2mm ²)	0.3 to 0.75mm ² core (Outside diameter: 2.8mm or less)	×	
Applicable solderless terminal		RAV1.25-3.5, RAV2-3.5	R1.25-3 (Sleeved solderless terminals cannot be used.)	×	
External power supply	Voltage	12/24VDC (10.2 to 40VDC)	12-24VDC (10.2 to 28.8V) (Ripple ratio within 5%)	△	Voltage over 28.8 VDC is not applicable.
	Current	8mA (24VDC TYP. /common)	10mA (at 24VDC) (Max. all points ON)	○	
Current consumption		0.115A (TYP. all points ON)	0.065A (TYP. all points ON)	○	
Dielectric withstand voltage (Across external circuit and internal circuit)		Between DC external terminals and ground, 500VAC rms, 1 minute	560VAC rms/3cycles (Altitude 2,000m)	○	
Insulation resistance		5MΩ or more by insulation resistance tester	10MΩ or more by insulation resistance tester	○	
Noise durability		By noise simulator of 500Vp-p noise voltage, 1μs noise width and 25 to 60Hz noise frequency	By noise simulator of 500Vp-p noise voltage, 1μs noise width and 25 to 60Hz noise frequency	○	
			First transient noise IEC61000-4-4: 1kV		
External dimensions		250 (H) × 37.5 (W) × 121 (D) mm	98 (H) × 27.4 (W) × 90 (D) mm	△	Wiring space is narrow.
Weight		0.36kg	0.16kg	△	

*1 The wiring change is not required by using the conversion adapter (ERNT-AQTY40) manufactured by Mitsubishi Electric Engineering Co., Ltd.

(19) Specifications comparison between AY40P and QY40P

○: Compatible, △: Partial change required, ×: Incompatible

Specification		AY40P	QY40P	Compat- ibility	Precautions for replacement
Number of output points		16 points	16 points	○	
Insulation method		Photocoupler	Photocoupler	○	
Rated load voltage		12/24VDC	12-24VDC	○	
Operating load voltage range		10.2-26.4VDC	10.2-28.8VDC	○	
Maximum load current		0.1A/point, 0.8A/common	0.1A/point, 1.6A/common	○	
Maximum inrush current		0.38A 5ms or less	0.7A 10ms or less	○	
Leakage current (OFF)		0.1mA or less	0.1mA or less	○	
Maximum voltage drop at ON		2.5VDC (0.1A) 1.75VDC (5mA) 1.7VDC (1mA)	0.1VDC (TYP.) 0.1A 0.2VDC (Max.) 0.1A	○	
Response time	OFF to ON	2ms or less	1ms or less	○	
	ON to OFF	2ms or less (Resistive load)	1ms or less (Rated load, resistance load)	○	
Surge suppressor		Clamp diode	Zener diode	○	
Common terminal arrangement		8 points/common (Common terminal: TB10, TB20)	16 points/common (Common terminal: TB18)	△	As the common changes from two commons to a common, wiring with a different voltage for each common is not possible.
Operation indication		ON indication (LED)	ON indication (LED)	○	
Protection function		Yes (overheat protection function, short circuit protection function) • Overheat protection function is activated in increments of 1 point.	Yes (overheat protection function, overload protection function) • Overheat protection function is activated in increments of 1 point. • Overload protection function is activated in increments of 1 point.	○	
External connection method		20-point terminal block connector (M3 × 6 screws)	18-point terminal block (M3 × 6 screws)	×	Wiring change is required.*1
Applicable wire size		0.75 to 2mm ²	0.3 to 0.75mm ² core (Outside diameter: 2.8mm or less)	×	
Applicable solderless terminal		R1.25-3, R2-3, RAV1.25-3, RAV2-3	R1.25-3 (Sleeved solderless terminals cannot be used.)	×	
External power supply	Voltage	12/24VDC (10.8 to 26.4VDC)	12-24VDC (10.2 to 28.8V) (Ripple ratio within 5%)	○	
	Current	15mA (24VDC TYP. /common)	10mA (at 24VDC) (Max. all points ON)	○	
Current consumption		0.115A (TYP. all points ON)	0.065A (TYP. all points ON)	○	
External dimensions		250 (H) × 37.5 (W) × 121 (D) mm	98 (H) × 27.4 (W) × 90 (D) mm	△	Wiring space is narrow.
Weight		0.36kg	0.16kg	△	

*1 The wiring change is not required by using the conversion adapter (ERNT-AQTY40) manufactured by Mitsubishi Electric Engineering Co., Ltd.

(20) Specifications comparison between AY40A and QY68A

○: Compatible, △: Partial change required, ×: Incompatible

Specification		AY40A	QY68A	Compat- ibility	Precautions for replacement
Number of output points		16 points	8 points (16 points occupied)	△	Use two QY68As when using 9 points or more.
Insulation method		Photocoupler	Photocoupler	○	
Rated load voltage		12/24VDC	5-24VDC	○	
Operating load voltage range		10.2 to 30VDC (Max. applied voltage)	4.5 to 28.8VDC	△	Voltage over 28.8 VDC is not applicable.
Maximum load current		0.3A/point	2A/point, 8A/unit	○	
Maximum inrush current		1A 100ms or less	8A 10ms or less	○	
Leakage current (OFF)		0.1mA or less	0.1mA or less	○	
Maximum voltage drop at ON		1.5VDC (50mA to 0.3A) 1.0VDC (50mA or less)	0.3VDC (Max.) 2A	○	
Response time	OFF to ON	2ms or less	3ms or less	△	Response time differs.
	ON to OFF	2ms or less (Resistive load)	10ms or less (Resistive load)	△	
Surge suppressor		Surge suppression diode	Zener diode	○	
Common terminal arrangement		Not provided (All points independent)	Not provided (All points independent)	○	
Operation indication		ON indication (LED)	ON indication (LED)	○	
External connection method		38-point terminal block connector (M3 × 6 screws)	18-point terminal block (M3 × 6 screws)	×	Wiring change is required.
Applicable wire size		0.75 to 2mm ²	0.3 to 0.75mm ² core (Outside diameter: 2.8mm or less)	×	
Applicable solderless terminal		R1.25-3, R2-3, RAV1.25-3, RAV2-3	R1.25-3 (Sleeved solderless terminals cannot be used.)	×	
Current consumption		0.19A (TYP. all points ON)	0.11A (TYP. all points ON)	△	Review current capacity when using two QY68As since current consumption is increased in that use.
External dimensions		250 (H) × 37.5 (W) × 131 (D) mm	98 (H) × 27.4 (W) × 90 (D) mm	△	Wiring space is narrow.
Weight		0.42kg	0.14kg	△	

(21) Specifications comparison between AY41 and QY41P

○: Compatible, △: Partial change required, ×: Incompatible

Specification		AY41	QY41P	Compat- ibility	Precautions for replacement
Number of output points		32 points	32 points	○	
Insulation method		Photocoupler	Photocoupler	○	
Rated load voltage		12/24VDC	12-24VDC	○	
Operating load voltage range		10.2 to 40VDC	10.2 to 28.8VDC	△	Voltage over 28.8 VDC is not applicable.
Maximum load current		0.1A/point 1.6A/common	0.1A/point 2A/common	△	Pay attention to the common current.
Maximum inrush current		0.4A	0.7A 10ms or less	○	
Leakage current (OFF)		0.1mA or less	0.1mA or less	○	
Maximum voltage drop at ON		2.5VDC (0.1A) 1.75VDC (5mA) 1.7VDC (1mA)	0.1VDC (TYP.) 0.1A 0.2VDC (Max.) 0.1A	○	
Response time	OFF to ON	2ms or less	1ms or less	○	
	ON to OFF	2ms or less (Resistance load)	1ms or less (Rated load, resistance load)	○	
Surge suppressor		Clamp diode	Zener diode	○	
Common terminal arrangement		16 points/common (Common terminal: TB18, TB36)	32 points/common (Common terminal: A01, A02)	△	As the common changes from two commons to a common, wiring with a different voltage for each common is not possible.
Operation indication		ON indication (LED)	ON indication (LED)	○	
Protection function		None	Yes (overheat protection function, overload protection function) • Overheat protection function is activated in increments of 1 point. • Overload protection function is activated in increments of 1 point.	○	
External connection method		38-point terminal block connector (M3 × 6 screws)	40-pin connector (Option)	×	Wiring change is required.*1
Applicable wire size		0.75 to 2mm ²	0.3mm ² (For A6CON1 or A6CON4)	×	
Applicable solderless terminal		R1.25-3, R2-3, RAV1.25-3, RAV2-3	—	×	
External power supply	Voltage	12/24VDC (10.2 to 40VDC)	12-24VDC (10.2 to 28.8V) (Ripple ratio within 5%)	△	Voltage over 28.8 VDC is not applicable.
	Current	20mA (24VDC TYP. /common)	20mA (at 24VDC)	○	
Current consumption		0.23A (TYP. all points ON)	0.105A (TYP. all points ON)	○	
External dimensions		250 (H) × 37.5 (W) × 131 (D) mm	98 (H) × 27.4 (W) × 90 (D) mm	△	
Weight		0.44kg	0.15kg	△	

*1 The wiring change is not required by using the conversion adapter (ERNT-AQTY41) manufactured by Mitsubishi Electric Engineering Co., Ltd. By using connectors/terminal block converter modules such as the A6TBXY36 and the conversion module such as the FA-TB32XY, conversion to the terminal block is possible.

(22) Specifications comparison between AY41P and QY41P

○: Compatible, △: Partial change required, ×: Incompatible

Specification		AY41P	QY41P	Compat- ibility	Precautions for replacement
Number of output points		32 points	32 points	○	
Insulation method		Photocoupler	Photocoupler	○	
Rated load voltage		12/24VDC	12-24VDC	○	
Operating load voltage range		10.8 to 26.4VDC	10.2 to 28.8VDC	○	
Maximum load current		0.1A/point 1.0A/common	0.1A/point 2A/common	○	
Maximum inrush current		0.38A 5ms or less	0.7A 10ms or less	○	
Leakage current (OFF)		0.1mA or less	0.1mA or less	○	
Maximum voltage drop at ON		2.5VDC (0.1A) 1.75VDC (5mA) 1.7VDC (1mA)	0.1VDC (TYP.) 0.1A 0.2VDC (Max.) 0.1A	○	
Response time	OFF to ON	2ms or less	1ms or less	○	
	ON to OFF	2ms or less (Resistance load)	1ms or less (Rated load, resistance load)	○	
Surge suppressor		Clamp diode	Zener diode	○	
Common terminal arrangement		16 points/common (Common terminal: TB18, TB36)	32 points/common (Common terminal: A01, A02)	△	As the common changes from two commons to a common, wiring with a different voltage for each common is not possible.
Operation indication		ON indication (LED)	ON indication (LED)	○	
Protection function		Yes (overheat protection function, short circuit protection function) Overheat protection function is activated in increments of 8 points.	Yes (overheat protection function, overload protection function) • Overheat protection function is activated in increments of 1 point. • Overload protection function is activated in increments of 1 point.	○	
External connection method		38-point terminal block connector (M3 × 6 screws)	40-pin connector (Option)	×	Wiring change is required.*1
Applicable wire size		0.75 to 2mm ²	0.3mm ² (For A6CON1 or A6CON4)	×	
Applicable solderless terminal		R1.25-3, R2-3, RAV1.25-3, RAV2-3	—	×	
External power supply	Voltage	12/24VDC (10.8 to 26.4VDC)	12-24VDC (10.2 to 28.8V) (Ripple ratio within 5%)	○	
	Current	30mA (24VDC TYP. /common)	20mA (at 24VDC)	○	
Current consumption		0.23A (TYP. all points ON)	0.105A (TYP. all points ON)	○	
External dimensions		250 (H) × 37.5 (W) × 131 (D) mm	98 (H) × 27.4 (W) × 90 (D) mm	△	
Weight		0.44kg	0.15kg	△	

*1 The wiring change is not required by using the conversion adapter (ERNT-AQTY41) manufactured by Mitsubishi Electric Engineering Co., Ltd. By using connectors/terminal block converter modules such as the A6TBXY36 and the conversion module such as the FA-TB32XY, conversion to the terminal block is possible.

(23) Specifications comparison between AY41-UL and QY41P

○: Compatible, △: Partial change required, ×: Incompatible

Specification		AY41-UL	QY41P	Compat- ibility	Precautions for replacement
Number of output points		32 points	32 points	○	
Insulation method		Photocoupler	Photocoupler	○	
Rated load voltage		12/24VDC	12-24VDC	○	
Operating load voltage range		10.2 to 40VDC	10.2 to 28.8VDC	△	Voltage over 28.8 VDC is not applicable.
Maximum load current		0.1A/point 1.6A/common	0.1A/point 2A/common	△	Pay attention to the common current.
Maximum inrush current		0.4A	0.7A 10ms or less	○	
Leakage current (OFF)		0.1mA or less	0.1mA or less	○	
Maximum voltage drop at ON		2.5VDC (0.1A) 1.75VDC (5mA) 1.7VDC (1mA)	0.1VDC (TYP.) 0.1A 0.2VDC (Max.) 0.1A	○	
Response time	OFF to ON	2ms or less	1ms or less	○	
	ON to OFF	2ms or less (Resistance load)	1ms or less (Rated load, resistance load)	○	
Surge suppressor		Clamp diode	Zener diode	○	
Common terminal arrangement		16 points/common (Common terminal: TB18, TB36)	32 points/common (Common terminal: A01, A02)	△	As the common changes from two commons to a common, wiring with a different voltage for each common is not possible.
Operation indication		ON indication (LED)	ON indication (LED)	○	
External connection method		38-point terminal block connector (M3.5 × 7 screws)	40-pin connector (Option)	×	Wiring change is required.*1
Applicable wire size		18 AWG to 14 AWG (0.75 to 2mm ²)	0.3mm ² (For A6CON1 or A6CON4)	×	
Applicable solderless terminal		RAV1.25-3.5, RAV2-3.5	-	×	
External power supply	Voltage	12/24VDC (10.2 to 40VDC)	12-24VDC (10.2 to 28.8VDC) (Ripple ratio within 5%)	△	Voltage over 28.8 VDC is not applicable.
	Current	20mA (24VDC TYP. /common)	20mA (at 24VDC)	○	
Current consumption		0.23A (TYP. all points ON)	0.105A (TYP. all points ON)	○	
Dielectric withstand voltage (Across external circuit and internal circuit)		Between DC external terminals and ground, 500VAC rms, 1 minute	560VAC rms/3cycles (Altitude 2,000m)	○	
Insulation resistance		5MΩ or more by insulation resistance tester	10MΩ or more by insulation resistance tester	○	
Noise durability		By noise simulator of 500Vp-p noise voltage, 1μs noise width and 25 to 60Hz noise frequency	By noise simulator of 500Vp-p noise voltage, 1μs noise width and 25 to 60Hz noise frequency First transient noise IEC61000-4-4: 1kV	○	
External dimensions		250 (H) × 37.5 (W) × 131 (D) mm	98 (H) × 27.4 (W) × 90 (D) mm	△	
Weight		0.44kg	0.15kg	△	

*1 By using connectors/terminal block converter modules such as the A6TBXY36 and the conversion module such as the FA-TB32XY, conversion to the terminal block is possible.

The wiring change is not required by using the conversion adapter (ERNT-AQTY41) manufactured by Mitsubishi Electric Engineering Co., Ltd.

(24) Specifications comparison between AY42 and QY42P

○: Compatible, △: Partial change required, ×: Incompatible

Specification		AY42	QY42P	Compat- ibility	Precautions for replacement
Number of output points		64 points	64 points	○	
Insulation method		Photocoupler	Photocoupler	○	
Rated load voltage		12/24VDC	12-24VDC	○	
Operating load voltage range		10.2 to 40VDC	10.2 to 28.8VDC	△	Voltage over 28.8 VDC is not applicable.
Maximum load current		0.1A/point, 2A/common (When placing next to the power supply module: 1.6A/common)	0.1A/point, 2A/common	○	
Maximum inrush current		0.4A	0.7A, 10ms or less	○	
Leakage current (OFF)		0.1mA or less	0.1mA or less	○	
Maximum voltage drop at ON		2.5VDC (0.1A) 1.75VDC (5mA) 1.7VDC (1mA)	0.1VDC (TYP.) 0.1A 0.2VDC (Max.) 0.1A	○	
Response time	OFF to ON	2ms or less	1ms or less	○	
	ON to OFF	2ms or less (Resistive load)	1ms or less (Rated load, resistance load)	○	
Surge suppressor		Clamp diode	Zener diode	○	
Common terminal arrangement		32 points/common (Common terminal: 1A1, 1A2, 2A1, 2A2)	32 points/common (Common terminal: 1A01, 1A02, 2A01, 2A02)	○	
Operation indication		ON indication (LED) 32 point switch-over using switch	ON indication (LED) 32 point switch-over using switch	○	
Protection function		-	Yes (overheat protection function, overload protection function) • Overheat protection function is activated in increments of 1 point. • Overload protection function is activated in increments of 1 point.	○	
External connection method		Two 40-pin connectors (Solder)	Two 40-pin connectors (Option)	○	The existing external wiring can be used without change.
Applicable wire size		0.3mm ²	0.3mm ² (For A6CON1 or A6CON4)	○	
External power supply	Voltage	12/24VDC (10.2 to 40VDC)	12-24VDC (10.2 to 28.8VDC) (Ripple ratio within 5%)	△	Voltage over 28.8 VDC is not applicable.
	Current	40mA (24VDC TYP. /common)	20mA (at 24VDC)/common	○	
Current consumption		0.34A (TYP. all points ON)	0.15A (TYP. all points ON)	○	
External dimensions		250 (H) × 37.5 (W) × 106 (D) mm	98 (H) × 27.4 (W) × 90 (D) mm	△	
Weight		0.50kg	0.17kg	△	

(25) Specifications comparison between AY42-S1 and QY42P

○: Compatible, △: Partial change required, ×: Incompatible

Specification		AY42-S1	QY42P	Compat- ibility	Precautions for replacement
Number of output points		64 points	64 points	○	
Insulation method		Photocoupler	Photocoupler	○	
Rated load voltage		12/24VDC	12-24VDC	○	
Operating load voltage range		10.2 to 40VDC	10.2 to 28.8VDC	△	Voltage over 28.8 VDC is not applicable.
Maximum load current		0.1A/point, 2A/common (When placing next to the power supply module: 1.6A/common)	0.1A/point, 2A/common	○	
Maximum inrush current		0.4A	0.7A, 10ms or less	○	
Leakage current (OFF)		0.1mA or less	0.1mA or less	○	
Maximum voltage drop at ON		2.5VDC (0.1A) 1.75VDC (5mA) 1.7VDC (1mA)	0.1VDC (TYP.) 0.1A 0.2VDC (Max.) 0.1A	○	
Response time	OFF to ON	0.1ms or less	1ms or less	△	Response time differs.
	ON to OFF	0.3ms or less (Resistance load)	1ms or less (Rated load, resistance load)	△	
Surge suppressor		Clamp diode	Zener diode	○	
Common terminal arrangement		32 points/common (Common terminal: 1A1, 1A2, 2A1, 2A2)	32 points/common (Common terminal: 1A01, 1A02, 2A01, 2A02)	○	
Operation indication		ON indication (LED) 32 point switch-over using switch	ON indication (LED) 32 point switch-over using switch	○	
Protection function		-	Yes (overheat protection function, overload protection function) • Overheat protection function is activated in increments of 1 point. • Overload protection function is activated in increments of 1 point.	○	
External connection method		Two 40-pin connectors (Solder)	Two 40-pin connectors (Option)	○	The existing external wiring can be used without change.
Applicable wire size		0.3mm ²	0.3mm ² (for A6CON1 or A6CON4)	○	
External power supply	Voltage	12/24VDC (10.2 to 40VDC)	12-24VDC (10.2 to 28.8VDC) (Ripple ratio within 5%)	△	Voltage over 28.8 VDC is not applicable.
	Current	40mA (24VDC TYP. /common)	20mA (at 24VDC)/common	○	
Current consumption		0.29A (TYP. all points ON)	0.15A (TYP. all points ON)	○	
External dimensions		250 (H) × 37.5 (W) × 106 (D) mm	98 (H) × 27.4 (W) × 90 (D) mm	△	
Weight		0.50kg	0.17kg	△	

(26) Specifications comparison between AY42-S3 and QY42P

○: Compatible, △: Partial change required, ×: Incompatible

Specification		AY42-S3	QY42P	Compat- ibility	Precautions for replacement
Number of output points		64 points	64 points	○	
Insulation method		Photocoupler	Photocoupler	○	
Rated load voltage		12/24VDC	12-24VDC	○	
Operating load voltage range		10.2 to 40VDC	10.2 to 28.8VDC	△	Voltage over 28.8 VDC is not applicable.
Maximum load current		0.1A/point, 2A/common (When placing next to the power supply module: 1.6A/common)	0.1A/point, 2A/common	○	
Maximum inrush current		0.4A/point 3.5A/fuse	0.7A 10ms or less	○	
Leakage current (OFF)		0.1mA or less	0.1mA or less	○	
Maximum voltage drop at ON		2.5VDC (0.1A) 1.75VDC (5mA) 1.7VDC (1mA)	0.1VDC (TYP.) 0.1A 0.2VDC (Max.) 0.1A	○	
Response time	OFF to ON	2ms or less	1ms or less	○	
	ON to OFF	2ms or less (Resistance load)	1ms or less (Rated load, resistance load)	○	
Surge suppressor		Clamp diode	Zener diode	○	
Common terminal arrangement		32 points/common (Common terminal: 1A1, 1A2, 2A1, 2A2)	32 points/common (Common terminal: 1A01, 1A02, 2A01, 2A02)	○	
Operation indication		ON indication (LED) 32 point switch-over using switch	ON indication (LED) 32 point switch-over using switch	○	
Protection function		-	Yes (overheat protection function, overload protection function) • Overheat protection function is activated in increments of 1 point. • Overload protection function is activated in increments of 1 point.	○	The QY42P has the protection function instead of a fuse.
Fuse		1.6A normal blow fuse (2 fuses per common)	None	×	
Fuse blow indicator		Yes	-	-	
External connection method		Two 40-pin connectors (Solder)	Two 40-pin connectors (Option)	○	The existing external wiring can be used without change.
Applicable wire size		0.3mm ²	0.3mm ² (for A6CON1 or A6CON4)	○	
External power supply	Voltage	12/24VDC (10.2 to 40VDC)	12-24VDC (10.2 to 28.8VDC) (Ripple ratio within 5%)	△	Voltage over 28.8 VDC is not applicable.
	Current	40mA (24VDC TYP. /common)	20mA (at 24VDC)/common	○	
Current consumption		0.29A (TYP.all points ON)	0.15A (TYP.all points ON)	○	
External dimensions		250 (H) × 37.5 (W) × 106 (D) mm	98 (H) × 27.4 (W) × 90 (D) mm	△	
Weight		0.50kg	0.17kg	△	

(27) Specifications comparison between AY42-S4 and QY42P

○: Compatible, △: Partial change required, ×: Incompatible

Specification		AY42-S4	QY42P	Compat- ibility	Precautions for replacement
Number of output points		64 points	64 points	○	
Insulation method		Photocoupler	Photocoupler	○	
Rated load voltage		12/24VDC	12-24VDC	○	
Operating load voltage range		10.2 to 30VDC	10.2 to 28.8VDC	△	Voltage over 28.8 VDC is not applicable.
Maximum load current		0.1A/point, 1.92A/common	0.1A/point, 2A/common	○	
Maximum inrush current		0.4A 10ms or less	0.7A 10ms or less	○	
Leakage current (OFF)		0.1mA or less	0.1mA or less	○	
Maximum voltage drop at ON		1.0VDC (TYP.) 0.1A 2.5VDC (Max.) 0.1A	0.1VDC (TYP.) 0.1A 0.2VDC (Max.) 0.1A	○	
Response time	OFF to ON	2ms or less	1ms or less	○	
	ON to OFF	2ms or less (Resistance load)	1ms or less (Rated load, resistance load)	○	
Surge suppressor		Zener diode build-in photocoupler	Zener diode	○	
Common terminal arrangement		32 points/common (Common terminal: 1A1, 1A2, 2A1, 2A2)	32 points/common (Common terminal: 1A01, 1A02, 2A01, 2A02)	○	
Operation indication		ON indication (LED) 32 point switch-over using switch	ON indication (LED) 32 point switch-over using switch	○	
Protection function		-	Yes (overheat protection function, overload protection function) • Overheat protection function is activated in increments of 1 point. • Overload protection function is activated in increments of 1 point.	○	
External connection method		Two 40-pin connectors (Solder)	Two 40-pin connectors (Option)	○	The existing external wiring can be used without change.
Applicable wire size		0.3mm ²	0.3mm ² (for A6CON1 or A6CON4)	○	
External power supply	Voltage	-	12-24VDC (10.2 to 28.8VDC) (Ripple ratio within 5%)	×	External power supply is required.
	Current	-	20mA (at 24VDC)/common	×	
Current consumption		0.50A (TYP.60% or less simultaneous ON)	0.15A (TYP. all points ON)	○	
External dimensions		250 (H) × 37.5 (W) × 106 (D) mm	98 (H) × 27.4 (W) × 90 (D) mm	△	
Weight		0.44kg	0.17kg	△	

(28) Specifications comparison between AY50 and QY50

○: Compatible, △: Partial change required, ×: Incompatible

Specification		AY50	QY50	Compat- ibility	Precautions for replacement
Number of output points		16 points	16 points	○	
Insulation method		Photocoupler	Photocoupler	○	
Rated load voltage		12/24VDC	12-24VDC	○	
Operating load voltage range		10.2 to 30VDC	10.2 to 28.8VDC	△	Voltage over 28.8 VDC is not applicable.
Maximum load current		0.5A/point, 2A/common	0.5A/point, 4A/common	○	
Maximum inrush current		7A 10ms or less 3.5A 100ms or less	4A 10ms or less	△	Carefully select load for use since the inrush current value differs.
Leakage current (OFF)		0.1mA or less	0.1mA or less	○	
Maximum voltage drop at ON		0.9VDC (TYP.) 0.5A 1.5VDC (Max.) 0.5A	0.2VDC (TYP.) 0.5A 0.3VDC (Max.) 0.5A	○	
Response time	OFF to ON	2ms or less	1ms or less	○	
	ON to OFF	2ms or less (Resistance load)	1ms or less (Rated load, resistance load)	○	
Surge suppressor		Varistor (52 to 62V)	Zener diode	○	
Common terminal arrangement		8 points/common (Common terminal: TB10, TB20)	16 points/common (Common terminal: TB18)	△	As the common changes from two commons to a common, wiring with a different voltage for each common is not possible.
Operation indication		ON indication (LED)	ON indication (LED)	○	
Fuse		2A fast blow fuse (1 fuse common) type	6.7A (unchangeable) (Fuse blow capacity : 50A)	△	Connect the fast blow fuse to the external if necessary.
Fuse blow indicator		Yes (LED is turned ON when fuse is blown. Signal is output to a programmable controller CPU.)	Yes (When fuse blows, LED indicates it and signal is output to CPU.)	△	The QY50 does not detect fuse blown unless the external power is supplied.
External connection method		20-point terminal block connector (M3 × 6 screws)	18-point terminal block (M3 × 6 screws)	×	Wiring change is required.*1
Applicable wire size		0.75 to 2mm ²	0.3 to 0.75mm ² core (Outside diameter: 2.8mm or less)	×	
Applicable solderless terminal		R1.25-3, R2-3, RAV1.25-3, RAV2-3	R1.25-3 (Sleeved solderless terminals cannot be used.)	×	
External power supply	Voltage	12/24VDC (10.2 to 30VDC)	12-24VDC (10.2 to 28.8VDC) (Ripple ratio within 5%)	△	Voltage over 28.8 VDC is not applicable.
	Current	65mA (24VDC TYP. /common)	20mA (at 24VDC)/common	○	
Current consumption		0.115A (TYP. all points ON)	0.08A (TYP. all points ON)	○	
External dimensions		250 (H) × 37.5 (W) × 121 (D) mm	98 (H) × 27.4 (W) × 90 (D) mm	△	Wiring space is narrow.
Weight		0.42kg	0.17kg	△	

*1 The wiring change is not required by using the conversion adapter (ERNT-AQTY50) manufactured by Mitsubishi Electric Engineering Co., Ltd.

(29) Specifications comparison between AY50-UL and QY50

○: Compatible, △: Partial change required, ×: Incompatible

Specification		AY50-UL	QY50	Compat- ibility	Precautions for replacement
Number of output points		16 points	16 points	○	
Insulation method		Photocoupler	Photocoupler	○	
Rated load voltage		12/24VDC	12-24VDC	○	
Operating load voltage range		10.2 to 30VDC	10.2 to 28.8VDC	△	Voltage over 28.8 VDC is not applicable.
Maximum load current		0.5A/point, 2A/common	0.5A/point, 4A/common	○	
Maximum inrush current		7A 10ms or less 3.5A 100ms or less	4A 10ms or less	△	Carefully select load for use since the inrush current value differs.
Leakage current (OFF)		0.1mA or less	0.1mA or less	○	
Maximum voltage drop at ON		0.9VDC (TYP.) 0.5A 1.5VDC (Max.) 0.5A	0.2VDC (TYP.) 0.5A 0.3VDC (Max.) 0.5A	○	
Response time	OFF to ON	2ms or less	1ms or less	○	
	ON to OFF	2ms or less (Resistance load)	1ms or less (Rated load, resistance load)	○	
Surge suppressor		Varistor (52 to 62V)	Zener diode	○	
Common terminal arrangement		8 points/common (Common terminal: TB10, TB20)	16 points/common (Common terminal: TB18)	△	As the common changes from two commons to a common, wiring with a different voltage for each common is not possible.
Operation indication		ON indication (LED)	ON indication (LED)	○	
Fuse		2A fast blow fuse (1 fuse common) type	6.7A (unchangeable) (Fuse blow capacity : 50A)	△	Connect the fast blow fuse to the external if necessary.
Fuse blow indicator		Yes (LED is turned ON when fuse is blown. Signal is output to a CPU module.)	Yes (When fuse blows, LED indicates it and signal is output to CPU module.)	△	The QY50 does not detect fuse blown unless the external power is supplied.
External connection method		20-point terminal block connector (M3.5 × 7 screws)	18-point terminal block (M3 × 6 screws)	×	Wiring change is required.*1
Applicable wire size		18 AWG to 14 AWG (0.75 to 2mm ²)	0.3 to 0.75mm ² core (Outside diameter: 2.8mm or less)	×	
Applicable solderless terminal		RAV1.25-3.5, RAV2-3.5	R1.25-3 (Sleeved solderless terminals cannot be used.)	×	
External power supply	Voltage	12/24VDC (10.2 to 30VDC)	12-24VDC (10.2 to 28.8VDC) (Ripple ratio within 5%)	△	Voltage over 28.8 VDC is not applicable.
	Current	65mA (24VDC TYP. /common)	20mA (at 24VDC)/common	○	
Current consumption		0.115A (TYP. all points ON)	0.08A (TYP. all points ON)	○	
Dielectric withstand voltage (Across external terminals and ground, 500VAC rms, 1 minute)		Between DC external terminals and ground, 500VAC rms, 1 minute	560VAC rms/3cycles (Altitude 2,000m)	○	
Insulation resistance		5MΩ or more by insulation resistance tester	10MΩ or more by insulation resistance tester	○	
Noise durability		By noise simulator of 500Vp-p noise voltage, 1μs noise width and 25 to 60Hz noise frequency	By noise simulator of 500Vp-p noise voltage, 1μs noise width and 25 to 60Hz noise frequency First transient noise IEC61000-4-4: 1kV	○	
External dimensions		250 (H) × 37.5 (W) × 121 (D) mm	98 (H) × 27.4 (W) × 90 (D) mm	△	Wiring space is narrow.
Weight		0.42kg	0.17kg	△	

*1 The wiring change is not required by using the conversion adapter (ERNT-AQTY50) manufactured by Mitsubishi Electric Engineering Co., Ltd.

(30) Specifications comparison between AY51 and QY50

○: Compatible, △: Partial change required, ×: Incompatible

Specification		AY51	QY50	Compat- ibility	Precautions for replacement
Number of output points		32 points	16 points	△	Use two QY50s when using 17 points or more.
Insulation method		Photocoupler	Photocoupler	○	
Rated load voltage		12/24VDC	12-24VDC	○	
Operating load voltage range		10.2 to 30VDC	10.2 to 28.8VDC	△	Voltage over 28.8 VDC is not applicable.
Maximum load current		0.5A/point, 4A/common (When placing next to the power supply module: 3.3A/common)	0.5A/point, 4A/common	○	
Maximum inrush current		4A 10ms or less	4A 10ms or less	○	
Leakage current (OFF)		0.1mA or less	0.1mA or less	○	
Maximum voltage drop at ON		0.9VDC (TYP.) 0.5A 1.5VDC (Max.) 0.5A	0.2VDC (TYP.) 0.5A 0.3VDC (Max.) 0.5A	○	
Response time	OFF to ON	2ms or less	1ms or less	○	
	ON to OFF	2ms or less (Resistance load)	1ms or less (Rated load, resistance load)	○	
Surge suppressor		Varistor (52 to 62V)	Zener diode	○	
Common terminal arrangement		16 points/common (Common terminal: TB18, TB36)	16 points/common (Common terminal: TB18)	○	
Operation indication		ON indication (LED)	ON indication (LED)	○	
Fuse		None	6.7A (Unchangeable) (Fuse blow capacity : 50A)	○	
Fuse blow indicator		–	Yes (When fuse blows, LED indicates it and signal is output to CPU.)	○	The QY50 does not detect fuse blown unless the external power is supplied.
External connection method		38-point terminal block connector (M3 × 6 screws)	18-point terminal block (M3 × 6 screws)	×	Wiring change is required.
Applicable wire size		0.75 to 2mm ²	0.3 to 0.75mm ² core (Outside diameter: 2.8mm or less)	×	
Applicable solderless terminal		R1.25-3, R2-3, RAV1.25-3, RAV2-3	R1.25-3 (Sleeved solderless terminals cannot be used.)	×	
External power supply	Voltage	12/24VDC (10.2 to 30VDC)	12-24VDC (10.2 to 28.8VDC) (Ripple ratio within 5%)	△	Voltage over 28.8 VDC is not applicable.
	Current	50mA (24VDC TYP. /common)	20mA (at 24VDC)/common	○	
Current consumption		0.23A (TYP. all points ON)	0.08A (TYP. all points ON)	○	
External dimensions		250 (H) × 37.5 (W) × 131 (D) mm	98 (H) × 27.4 (W) × 90 (D) mm	△	Wiring space is narrow.
Weight		0.53kg	0.17kg	△	

(31) Specifications comparison between AY51-S1 and QY50

○: Compatible, △: Partial change required, ×: Incompatible

Specification		AY51-S1	QY50	Compat- ibility	Precautions for replacement
Number of output points		32 points	16 points	△	Use two QY50s when using 17 points or more.
Insulation method		Photocoupler	Photocoupler	○	
Rated load voltage		12/24VDC	12-24VDC	○	
Operating load voltage range		10.2 to 30VDC	10.2 to 28.8VDC	△	Voltage over 28.8 VDC is not applicable.
Maximum load current		0.3A/point, 2A/common (1A fuse common)	0.5A/point, 4A/common	○	
Maximum inrush current		3A 10ms or less	4A 10ms or less	○	
Leakage current (OFF)		0.1mA or less	0.1mA or less	○	
Maximum voltage drop at ON		1VDC (TYP.) 0.3A 1.5VDC (Max.) 0.3A	0.2VDC (TYP.) 0.5A 0.3VDC (Max.) 0.5A	○	
Response time	OFF to ON	2ms or less	1ms or less	○	
	ON to OFF	2ms or less (Resistance load)	1ms or less (Rated load, resistance load)	○	
Surge suppressor		Transistor built-in zener diode	Zener diode	○	
Common terminal arrangement		16 points/common (Common terminal: TB18,TB36) 8 points/fuse common	16 points/common (Common terminal: TB18)	○	
Operation indication		ON indication (LED)	ON indication (LED)	○	
Fuse		1A fast blow fuse (2 fuses per common in units of 8 points) MP-10	6.7A (Unchangeable) (Fuse blow capacity : 50A)	△	Connect the fast blow fuse to the external if necessary.
Fuse blow indicator		Yes (LED is turned ON when fuse is blown. Signal is output to a programmable controller CPU.)	Yes (When fuse blows, LED indicates it and signal is output to CPU.)	△	The QY50 does not detect fuse blown unless the external power is supplied.
External connection method		38-point terminal block connector (M3 × 6 screws)	18-point terminal block (M3 × 6 screws)	×	Wiring change is required.
Applicable wire size		0.75 to 2mm ²	0.3 to 0.75mm ² core (Outside diameter: 2.8mm or less)	×	
Applicable solderless terminal		R1.25-3, R2-3, RAV1.25-3, RAV2-3	R1.25-3 (Sleeved solderless terminals cannot be used.)	×	
External power supply	Voltage	12/24VDC (10.2 to 30VDC)	12-24VDC (10.2 to 28.8VDC) (Ripple ratio within 5%)	△	Voltage over 28.8 VDC is not applicable.
	Current	100mA (24VDC TYP. /common)	20mA (at 24VDC)/common	○	
Current consumption		0.31A (TYP. all points ON)	0.08A (TYP. all points ON)	○	
External dimensions		250 (H) × 37.5 (W) × 131 (D) mm	98 (H) × 27.4 (W) × 90 (D) mm	△	Wiring space is narrow.
Weight		0.55kg	0.17kg	△	

(32) Specifications comparison between AY51-UL and QY50

○: Compatible, △: Partial change required, ×: Incompatible

Specification		AY51-UL	QY50	Compat- ibility	Precautions for replacement
Number of output points		32 points	16 points	△	Use two QY50s when using 17 points or more.
Insulation method		Photocoupler	Photocoupler	○	
Rated load voltage		12/24VDC	12-24VDC	○	
Operating load voltage range		10.2 to 30VDC	10.2 to 28.8VDC	△	Voltage over 28.8 VDC is not applicable.
Maximum load current		0.5A/point, 4A/common (When placing next to the power supply module: 3.3A/common)	0.5A/point, 4A/common	○	
Maximum inrush current		0.4A 10ms or less	4A 10ms or less	○	
Leakage current (OFF)		0.1mA or less	0.1mA or less	○	
Maximum voltage drop at ON		0.9VDC (TYP.) 0.5A 1.5VDC (Max.) 0.5A	0.2VDC (TYP.) 0.5A 0.3VDC (Max.) 0.5A	○	
Response time	OFF to ON	2ms or less	1ms or less	○	
	ON to OFF	2ms or less (Resistance load)	1ms or less (Rated load, resistance load)	○	
Surge suppressor		Varistor (52 to 62V)	Zener diode	○	
Common terminal arrangement		16 points/common (Common terminal: TB18, TB36)	16 points/common (Common terminal: TB18)	○	
Operation indication		ON indication (LED)	ON indication (LED)	○	
Fuse		None	6.7A (Unchangeable) (Fuse blow capacity : 50A)	○	
Fuse blow indicator		-	Yes (When fuse blows, LED indicates it and signal is output to CPU.)	○	The QY50 does not detect fuse blown unless the external power is supplied.
External connection method		38-point terminal block connector (M3.5 × 7 screws)	18-point terminal block (M3 × 6 screws)	×	Wiring change is required.
Applicable wire size		18 AWG to 14 AWG (0.75 to 2mm ²)	0.3 to 0.75mm ² core (Outside diameter: 2.8mm or less)	×	
Applicable solderless terminal		RAV1.25-3.5, RAV2-3.5	R1.25-3 (Sleeved solderless terminals cannot be used.)	×	
External power supply	Voltage	12/24VDC (10.2 to 30VDC)	12-24VDC (10.2 to 28.8VDC) (Ripple ratio within 5%)	△	Voltage over 28.8 VDC is not applicable.
	Current	50mA (24VDC TYP. /common)	20mA (at 24VDC)/common	○	
Current consumption		0.23A (TYP. all points ON)	0.08A (TYP. all points ON)	○	
Dielectric withstand voltage (Across external circuit and internal circuit)		Between DC external terminals and ground, 500VAC rms, 1 minute	560VAC rms/3cycles (Altitude 2,000m)	○	
Insulation resistance		5MΩ or more by insulation resistance tester	10MΩ or more by insulation resistance tester	○	
Noise durability		By noise simulator of 500Vp-p noise voltage, 1μs noise width and 25 to 60Hz noise frequency	By noise simulator of 500Vp-p noise voltage, 1μs noise width and 25 to 60Hz noise frequency	○	
			First transient noise IEC61000-4-4: 1kV		
External dimensions		250 (H) × 37.5 (W) × 131 (D) mm	98 (H) × 27.4 (W) × 90 (D) mm	△	Wiring space is narrow.
Weight		0.53kg	0.17kg	△	

(33) Specifications comparison between AY60 and QY68A

○: Compatible, △: Partial change required, ×: Incompatible

Specification		AY60	QY68A	Compat- ibility	Precautions for replacement
Number of output points		16 points	8 points (16 points occupied)	△	Use two QY68As when using 9 points or more.
Insulation method		Photocoupler	Photocoupler	○	
Rated load voltage		24VDC (12/48V)	5-24VDC	△	Voltage over 28.8 VDC is not applicable.
Operating load voltage range		21.6 to 26.4VDC (10.2 to 56VDC)	4.5 to 28.8VDC	△	Voltage over 28.8 VDC is not applicable.
Maximum load current		2A/point, 5A/common (3A/fuse) (When placing next to the power supply module: 3A/common)	2A/point, 8A/module	△	Since the maximum load current per common is different, pay attention to the current used in the entire module.
Maximum inrush current		4A 100ms or less, 8A 10ms or less	8A 10ms or less	○	
Leakage current (OFF)		0.1mA or less	0.1mA or less	○	
Maximum voltage drop at ON		1.5VDC (2A)	0.3VDC (Max.) 2A	○	
Response time	OFF to ON	2ms or less	3ms or less	△	Response time differs.
	ON to OFF	2ms or less (Resistance load)	10ms or less (Resistance load)	△	
Surge suppressor		Varistor (108 to 132V)	Zener diode	○	
Common terminal arrangement		8 points/common (Common terminal: TB10, TB20)	Not provided (All points independent)	△	The wiring of terminal block differs since all the contacts of the QY68A are independent.
Operation indication		ON indication (LED)	ON indication (LED)	○	
Fuse		3.2A fast blow fuse (2 fuses/common) type MP-32	None (Installing a fuse to an external cable is recommended.)	×	Fuses are not built in. *1
Fuse blow indicator		Yes (When fuse blows, LED indicates it and signal is output to CPU.)	–	×	
External connection method		20-point terminal block connector (M3 × 6 screws)	18-point terminal block (M3 × 6 screws)	×	Wiring change is required.
Applicable wire size		0.75 to 2mm ²	0.3 to 0.75mm ² core (Outside diameter: 2.8mm or less)	×	
Applicable solderless terminal		R1.25-3, R2-3, RAV1.25-3, RAV2-3	R1.25-3 (Sleeved solderless terminals cannot be used.)	×	
External power supply	Voltage	24VDC (21.6 to 26.4VDC)	–	○	External power supply is not required.
	Current	65mA (24VDC TYP. /common)	–		
Current consumption		0.115A (TYP. all points ON)	0.11A (TYP. all points ON)	○	Review current capacity when using two QY68As since current consumption is increased in that use.
External dimensions		250 (H) × 37.5 (W) × 121 (D) mm	98 (H) × 27.4 (W) × 90 (D) mm	△	Wiring space is narrow.
Weight		0.64kg	0.14kg	△	

*1 Mount a fuse on every external terminal to prevent the external device and module deterioration upon load short circuit. Also, configure an external circuit when displaying fuse blown is required.

(34) Specifications comparison between AY60E and QY68A

○: Compatible, △: Partial change required, ×: Incompatible

Specification		AY60E	QY68A	Compat- ibility	Precautions for replacement
Number of output points		16 points	8 points (16 points occupied)	△	Use two QY68As when using 9 points or more.
Insulation method		Photocoupler	Photocoupler	○	
Rated load voltage		24VDC (12/48V)	5-24VDC	△	Voltage over 28.8 VDC is not applicable.
Operating load voltage range		21.6 to 26.4VDC (10.2 to 56VDC)	4.5 to 28.8VDC	△	Voltage over 28.8 VDC is not applicable.
Maximum load current		12/24VDC 2A/points 48VDC 0.8A/points 5A/common (When placing next to the power supply module: 3A/common)	2A/points 8A/unit	△	Since the maximum load current per common is different, pay attention to the current used in the entire module.
Maximum inrush current		4A 100ms or less 8A 10ms or less	8A 10ms or less	○	
Leakage current (OFF)		0.1mA or less	0.1mA or less	○	
Maximum voltage drop at ON		1.5VDC (2A)	0.3VDC (Max.) 2A	○	
Response time	OFF to ON	2ms or less	3ms or less	△	Response time differs.
	ON to OFF	2ms or less (Resistance load)	10ms or less (Resistance load)	△	
Surge suppressor		Surge suppression diode	Zener diode	○	
Common terminal arrangement		8 points/common (Common terminal: TB10, TB20)	Not provided (All points independent)	△	The wiring of terminal block differs since all the contacts of the QY68A are independent.
Fuse		5A fast blow fuse (2 fuses/common) type	None (Installing a fuse to an external cable is recommended.)	×	Fuses are not built in. *1
Fuse blow indicator		Yes (When fuse is blows, LED indicates it signal is output to CPU.)	—	×	
Operation indication		ON indication (LED)	ON indication (LED)	○	
External connection method		20-point terminal block connector (M3 × 6 screws)	18-point terminal block (M3 × 6 screws)	×	Wiring change is required.
Applicable wire size		0.75 to 2mm ²	0.3 to 0.75mm ² core (Outside diameter: 2.8mm or less)	×	
Applicable solderless terminal		R1.25-3, R2-3 RAV1.25-3, RAV2-3	R1.25-3 (Sleeved solderless terminals cannot be used.)	×	
External power supply	Voltage	24VDC (21.6 to 26.4VDC)	—	○	External power supply is not required.
	Current	65mA (24VDC TYP. /common)	—		
Current consumption		0.115A (TYP. all points ON)	0.11A (TYP. all points ON)	△	Review current capacity when using two QY68As since current consumption is increased in that use.
External dimensions		250 (H) × 37.5 (W) × 121 (D) mm	98 (H) × 27.4 (W) × 90 (D) mm	△	Wiring space is narrow.
Weight		0.63kg	0.14kg	△	

*1 Mount a fuse on every external terminal to prevent external devices and modules from burning out upon load short circuit. Also, configure an external circuit when fuse blown display is necessary.

(35) Specifications comparison between AY60EP and QY68A

○: Compatible, △: Partial change required, ×: Incompatible

Specification		AY60EP	QY68A	Compat- ibility	Precautions for replacement
Number of output points		16 points	8 points (16 points occupied)	△	Use two QY68As when using 9 points or more.
Insulation method		Photocoupler	Photocoupler	○	
Rated load voltage		12/24VDC	5-24VDC	○	
Operating load voltage range		10.2 to 26.4VDC	4.5 to 28.8VDC	○	
Maximum load current		2A/points 0.8A/point (60% ON, 55°C)*1	2A/points 8A/unit	○	
Maximum inrush current		No limit (Short protect function)	8A 10ms or less	△	Carefully select load for use since the inrush current value differs.
Leakage current (OFF)		1mA or less	0.1mA or less	○	
Maximum voltage drop at ON		1.6VDC (TYP.) 2A 2.0VDC (Max.) 2A	0.3VDC (Max.) 2A	○	
Response time	OFF to ON	0.5ms or less	3ms or less	△	Response time differs.
	ON to OFF	1.5ms or less	10ms or less (Resistance load)	△	
Surge suppressor		Surge suppression diode	Zener diode	○	
Common terminal arrangement		8 points/common (Common terminal: TB9, TB19)	Not provided (All points independent)	△	The wiring of terminal block differs since all the contacts of the QY68A are independent.
Operation indication		ON indication (LED)	ON indication (LED)	○	
Protection function		Yes (Overheat protection function, overload protection function.) • Overheat protection function is activated in units of 2 points.	None	×	Connect a fuse to the external if necessary.
Protection detection display		Yes (LED is turned ON when overheat protection and overload protection occur. Signal is output to a CPU module.)			
Protection reset method		Automatic reset (Reset by canceling Overheat protection func.)			
External connection method		20-point terminal block connector (M3 × 6 screws)	18-point terminal block (M3 × 6 screws)	×	Wiring change is required.
Applicable wire size		0.75 to 2mm ² (Applicable tightening torque: 68.6N·cm)	0.3 to 0.75mm ² core (Outside diameter: 2.8mm or less)	×	
Applicable solderless terminal		R1.25-3, R2-3 RAV1.25-3, RAV2-3	R1.25-3 (Sleeved solderless terminals cannot be used.)	×	
External power supply	Voltage	12/24VDC (10.2 to 26.4VDC)	—	○	External power supply is not required.
	Current	110mA (24VDC TYP. /common)	—		
Current consumption		0.115A (TYP. all points ON)	0.11A (TYP. all points ON)	○	
External dimensions		250 (H) × 37.5 (W) × 121 (D) mm	98 (H) × 27.4 (W) × 90 (D) mm	△	Wiring space is narrow.
Weight		0.55kg	0.14kg	△	

*1 The following shows the derating chart.

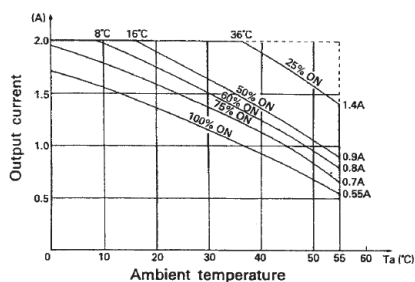

(36) Specifications comparison between AY60S and QY68A

○: Compatible, △: Partial change required, ×: Incompatible

Specification		AY60S	QY68A	Compat- ibility	Precautions for replacement
Number of output points		16 points	8 points (16 points occupied)	△	Use two QY68As when using 9 points or more.
Insulation method		Photocoupler	Photocoupler	○	
Rated load voltage		24/48VDC (12V)	5-24VDC	△	Voltage over 28.8VDC is not applicable.
Operating load voltage range		21.6 to 52.8VDC (10.2 to 52.8VDC)	4.5 to 28.8VDC	△	Voltage over 28.8VDC is not applicable.
Maximum load current		2A/points, 6.4A/common (5A/ fuse) (When placing next to the power supply module: 5A/common)	2A/points, 8A/unit	○	
Maximum inrush current		4A 100ms or less, 8A 10ms or less	8A 10ms or less	○	
Leakage current (OFF)		0.1mA or less	0.1mA or less	○	
Maximum voltage drop at ON		1VDC (2A)	0.3VDC (Max.) 2A	○	
Response time	OFF to ON	1ms or less	3ms or less	△	Response time differs.
	ON to OFF	3ms or less (Resistive load)	10ms or less (Resistive load)	△	
Surge suppressor		Varistor (90 to 110V)	Zener diode	○	
Common terminal arrangement		8 points/common (Common terminal: TB10, TB20)	Not provided (All points independent)	△	The wiring of terminal block differs since all the contacts of the QY68A are independent.
Operation indication		ON indication (LED)	ON indication (LED)	○	
Fuse		5A fast blow fuse (2 fuses/common) type MP-50	None (Installing a fuse to an external cable is recommended.)	×	Fuses are not built in. *1
Fuse blow indicator		Yes (When fuse is blows, LED indicates it signal is output to CPU.)	–	×	
External connection method		20-point terminal block connector (M3 × 6 screws)	18-point terminal block (M3 × 6 screws)	×	Wiring change is required.
Applicable wire size		0.75 to 2mm ²	0.3 to 0.75mm ² core (Outside diameter: 2.8mm or less)	×	
Applicable solderless terminal		R1.25-3, R2-3, RAV1.25-3, RAV2-3	R1.25-3 (Sleeved solderless terminals cannot be used.)	×	
External power supply	Voltage	24/48VDC (21.6 to 52.8VDC)	–	○	External power supply is not required.
	Current	3mA (24VDC TYP. /common)	–		
Current consumption		0.075A (TYP. all points ON)	0.11A (TYP. all points ON)	○	Review current capacity since current consumption is increased.
External dimensions		250 (H) × 37.5 (W) × 121 (D) mm	98 (H) × 27.4 (W) × 90 (D) mm	△	Wiring space is narrow.
Weight		0.66kg	0.14kg	△	

*1 Mount a fuse on every external terminal to prevent external devices and modules from burning out upon load short circuit. Also, configure an external circuit when fuse blown display is necessary.

(37) Specifications comparison between AY60S-UL and QY68A

○: Compatible, △: Partial change required, ×: Incompatible

Specification		AY60S-UL	QY68A	Compat- ibility	Precautions for replacement
Number of output points		16 points	8 points (16 points occupied)	△	Use two QY68As when using 9 points or more.
Insulation method		Photocoupler	Photocoupler	○	
Rated load voltage		24VDC (12V)	5-24VDC	△	
Operating load voltage range		21.6 to 26.4VDC (10.2 to 26.4VDC)*1	4.5 to 28.8VDC	△	
Maximum load current		2A/points, 6.4A/common (5A/ fuse) (When placing next to the power supply module: 5A/common)	2A/points, 8A/unit	○	
Maximum inrush current		4A 100ms or less, 8A 10ms or less	8A 10ms or less	○	
Leakage current (OFF)		0.1mA or less	0.1mA or less	○	
Maximum voltage drop at ON		1VDC (2A)	0.3VDC (Max.) 2A	○	
Response time	OFF to ON	1ms or less	3ms or less	△	Response time differs.
	ON to OFF	3ms or less (Resistive load)	10ms or less (Resistive load)	△	
Surge suppressor		Varistor (90 to 110V)	Zener diode	○	
Common terminal arrangement		8 points/common (Common terminal: TB10, TB20)	Not provided (All points independent)	△	The wiring of terminal block differs since all the contacts of the QY68A are independent.
Operation indication		ON indication (LED)	ON indication (LED)	○	
Fuse		5A fast blow fuse (2 fuses/common)	None (Installing a fuse to an external cable is recommended.)	×	Fuses are not built in. *1
Fuse blow indicator		Yes (When fuse is blows, LED indicates it signal is output to CPU module.)	–	×	
External connection method		20-point terminal block connector (M3.5 × 7 screws)	18-point terminal block (M3 × 6 screws)	×	Wiring change is required.
Applicable wire size		18 AWG to 14 AWG (0.75 to 2mm ²)	0.3 to 0.75mm ² core (Outside diameter: 2.8mm or less)	×	
Applicable solderless terminal		RAV1.25-3.5, RAV2-3.5	R1.25-3 (Sleeved solderless terminals cannot be used.)	×	
External power supply	Voltage	12/24VDC (10.2 to 26.4VDC)	–	○	External power supply is not required.
	Current	110mA (24VDC TYP. /common)	–		
Current consumption		0.075A (TYP. all points ON)	0.11A (TYP. all points ON)	△	Review current capacity since current consumption is increased.
Dielectric withstand voltage (Across external circuit and internal circuit)		Between DC external terminals and ground, 500VAC rms, 1 minute	560VAC rms/3cycles (Altitude 2,000m)	○	
Insulation resistance		5MΩ or more by insulation resistance tester	10MΩ or more by insulation resistance tester	○	
Noise durability		By noise simulator of 500Vp-p noise voltage, 1μs noise width and 25 to 60Hz noise frequency	By noise simulator of 500Vp-p noise voltage, 1μs noise width and 25 to 60Hz noise frequency First transient noise IEC61000-4-4: 1kV	○	
External dimensions		250 (H) × 37.5 (W) × 121 (D) mm	98 (H) × 27.4 (W) × 90 (D) mm	△	Wiring space is narrow.
Weight		0.66kg	0.14kg	△	

*1 When 12VDC is used as a load power supply, the 24VDC power supply as an external power supply is required.

(38) Specifications comparison between AY70 and QY70

○: Compatible, △: Partial change required, ×: Incompatible

Specification		AY70	QY70	Compat- ibility	Precautions for replacement
Number of output points		16 points	16 points	○	
Insulation method		Photocoupler	Photocoupler	○	
Rated load voltage		5/12VDC	5-12VDC	○	
Operating load voltage range		4.5 to 15VDC	4.5 to 15VDC	○	
Maximum load current		16mA/point 128mA/common	16mA/point 256mA/common	○	
Maximum inrush current		50mA 10ms	40mA 10ms of less	△	Carefully select load for use since the inrush current value differs.
Output voltage at OFF		V _{OH} : 3.5VDC (V _{CC} = 5VDC, I _{OH} = 0.4mA)	V _{OH} : 3.5VDC (V _{CC} = 5VDC, I _{OH} = 0.4mA)	○	
Maximum voltage drop at ON		V _{OL} : 0.2VDC (I _{OL} : 16mA)	V _{OL} : 0.3VDC	△	Check the input specification of an external equipment to be connected since the maximum voltage drop is bigger when turning on.
Response time	OFF to ON	1ms or less	0.5ms or less	○	
	ON to OFF	1ms or less	0.5ms or less (Resistive load)	○	
Common terminal arrangement		8 points/common (Common terminal: TB10, TB20)	16 points/common (Common terminal: TB18)	△	As the common changes from two commons to a common, wiring with a different voltage for each common is not possible.
Operation indication		ON indication (LED)	ON indication (LED)	○	
Fuse		None	1.6A (Unchangeable) (Fuse blow capacity: 50A)	○	
Fuse blow indicator		–	Yes (LED is turned ON when fuse is blown. Signal is output to a CPU module.)	○	
External connection method		20-point terminal block connector (M3 × 6 screws)	18-point terminal block (M3 × 6 screws)	×	Wiring change is required.*1
Applicable wire size		0.75 to 2mm ²	0.3 to 0.75mm ² core (Outside diameter: 2.8mm or less)	×	
Applicable solderless terminal		R1.25-3, R2-3, RAV1.25-3, RAV2-3	R1.25-3 (Sleeved solderless terminals cannot be used.)	×	
External power supply	Voltage	5/12VDC (4.5 to 15VDC)	5-12VDC (4.5 to 15V) (Ripple ratio within 5%)	○	
	Current	55mA (12VDC TYP. /common)	90mA (at 12VDC) (Max. all points ON)	○	
Current consumption		0.10A (TYP. all points ON)	0.095A (TYP. all points ON)	○	
External dimensions		250 (H) × 37.5 (W) × 121 (D) mm	98 (H) × 27.4 (W) × 90 (D) mm	△	Wiring space is narrow.
Weight		0.36kg	0.14kg	△	

*1 The wiring change is not required by using the conversion adapter (ERNT-AQTY40) manufactured by Mitsubishi Electric Engineering Co., Ltd.

(39) Specifications comparison between AY70-UL and QY70

○: Compatible, △: Partial change required, ×: Incompatible

Specification		AY70-UL	QY70	Compat- ibility	Precautions for replacement
Number of output points		16 points	16 points	○	
Insulation method		Photocoupler	Photocoupler	○	
Rated load voltage		5/12VDC	5-12VDC	○	
Operating load voltage range		4.5 to 15VDC	4.5 to 15VDC	○	
Maximum load current		16mA/point 128mA/common	16mA/point 256mA/common	○	
Maximum inrush current		50mA 10ms	40mA 10ms or less	△	Carefully select load for use since the inrush current value differs.
Output voltage at OFF		V _{OH} : 3.5VDC (V _{CC} = 5VDC, I _{OH} = 0.4mA)	V _{OH} : 3.5VDC (V _{CC} = 5VDC, I _{OH} = 0.4mA)	○	
Maximum voltage drop at ON		V _{OL} : 0.2VDC (I _{OL} : 16mA)	V _{OL} : 0.3VDC	△	Check the input specification of an external equipment to be connected since the maximum voltage drop is bigger when turning on.
Response time	OFF to ON	1ms or less	0.5ms or less	○	
	ON to OFF	1ms or less	0.5ms or less (Resistive load)	○	
Common terminal arrangement		8 points/common (Common terminal: TB10, TB20)	16 points/common (Common terminal: TB18)	△	As the common changes from two commons to a common, wiring with a different voltage for each common is not possible.
Operation indication		ON indication (LED)	ON indication (LED)	○	
Fuse		None	1.6A (Unchangeable) (Fuse blow capacity: 50A)	○	
Fuse blow indicator		–	Yes (LED is turned ON when fuse is blown. Signal is output to a CPU module.)	○	
External connection method		38-point terminal block connector (M3.5 × 7 screws)	18-point terminal block (M3 × 6 screws)	×	Wiring change is required.*1
Applicable wire size		18 AWG to 14 AWG (0.75 to 2mm ²)	0.3 to 0.75mm ² core (Outside diameter: 2.8mm or less)	×	
Applicable solderless terminal		RAV1.25-3.5, RAV2-3.5	R1.25-3 (Sleeved solderless terminals cannot be used.)	×	
External power supply	Voltage	5/12VDC (4.5 to 15VDC)	5-12VDC (4.5 to 15V) (Ripple ratio within 5%)	○	
	Current	55mA (12VDC TYP. /common)	90mA (at 12VDC) (Max. all points ON)	○	
Current consumption		0.10A (TYP. all points ON)	0.095A (TYP. all points ON)	○	
Dielectric withstand voltage (Across external circuit and internal circuit)		Between DC external terminals and ground, 500VAC rms, 1 minute	560VAC rms/3cycles (Altitude 2,000m)	○	
Insulation resistance		5MΩ or more by insulation resistance tester	10MΩ or more by insulation resistance tester	○	
Noise durability		By noise simulator of 500Vp-p noise voltage, 1μs noise width and 25 to 60Hz noise frequency	By noise simulator of 500Vp-p noise voltage, 1μs noise width and 25 to 60Hz noise frequency First transient noise IEC61000-4-4: 1kV	○	
External dimensions		250 (H) × 37.5 (W) × 131 (D) mm	98 (H) × 27.4 (W) × 90 (D) mm	△	Wiring space is narrow.
Weight		0.36kg	0.14kg	△	

*1 The wiring change is not required by using the conversion adapter (ERNT-AQTY40) manufactured by Mitsubishi Electric Engineering Co., Ltd.

(40) Specifications comparison between AY71 and QY71

○: Compatible, △: Partial change required, ×: Incompatible

Specification		AY71	QY71	Compat- ibility	Precautions for replacement
Number of output points		32 points	32 points	○	
Insulation method		Photocoupler	Photocoupler	○	
Rated load voltage		5/12VDC	5-12VDC	○	
Operating load voltage range		4.5 to 15VDC	4.5 to 15VDC	○	
Maximum load current		16mA/point 256mA/common (Sink loading)	16mA/point 512mA/common	○	
Maximum inrush current		50mA 10ms	40mA 10ms or less	△	Carefully select load for use since the inrush current value differs.
Output voltage at OFF		V _{OH} : 3.5VDC (V _{CC} = 5VDC, I _{OH} = 0.4mA)	V _{OH} : 3.5VDC (V _{CC} = 5VDC, I _{OH} = 0.4mA)	○	
Maximum voltage drop at ON		V _{OL} : 0.2VDC (I _{OL} : 16mA)	V _{OL} : 0.3VDC	△	Check the input specifications of an external equipment to be connected since the maximum voltage drop is bigger when turning on.
Response time	OFF to ON	1ms or less	0.5ms or less	○	
	ON to OFF	1ms or less	0.5ms or less (Resistive load)	○	
Common terminal arrangement		16 points/common (Common terminal: TB18, TB36)	32 points/common (Common terminal: A01, A02)	△	As the common changes from two commons to a common, wiring with a different voltage for each common is not possible.
Operation indication		ON indication (LED)	ON indication (LED)	○	
Fuse		None	1.6A (Unchangeable) (Fuse blow capacity: 50A)	○	
Fuse blow indicator		–	Yes (When fuse is blows, LED indicates it signal is output to CPU.)	○	
External connection method		38-point terminal block connector (M3 × 6 screws)	40-pin connector (Option)	×	Wiring change is required.*1
Applicable wire size		0.75 to 2mm ²	0.3mm ² (For A6CON1, or A6CON4)	×	
Applicable solderless terminal		R1.25-3, R2-3, RAV1.25-3, RAV2-3	-	×	
External power supply	Voltage	5/12VDC (4.5 to 15VDC)	5-12VDC (4.5 to 15VDC) (Ripple ratio within 5%)	○	
	Current	100mA (12VDC TYP. /common)	170mA (at 12VDC) (Max. all points ON)	○	
Current consumption		0.20A (TYP. all points ON)	0.15A (TYP. all points ON)	○	
External dimensions		250 (H) × 37.5 (W) × 131 (D) mm	98 (H) × 27.4 (W) × 90 (D)mm	△	
Weight		0.44kg	0.14kg	△	

*1 The wiring change is not required by using the conversion adapter (ERNT-AQTY41) manufactured by Mitsubishi Electric Engineering Co., Ltd. By using the conversion module such as the FA-TB32XY, conversion to the terminal block is possible.

(41) Specifications comparison between AY72 and QY71

○: Compatible, △: Partial change required, ×: Incompatible

Specification		AY72	QY71	Compat- ibility	Precautions for replacement
Number of output points		64 points	32 points	△	Use two QY71s when using 33 points or more.
Insulation method		Photocoupler	Photocoupler	○	
Rated load voltage		5/12VDC	5-12VDC	○	
Operating load voltage range		4.5 to 15VDC	4.5 to 15VDC	○	
Maximum load current		16mA/point, 512mA/common (Sink loading)	16mA/point, 512mA/common	○	
Maximum inrush current		50mA 10ms	40mA 10ms or less	△	Carefully select load for use since the inrush current value differs.
Output voltage at OFF		V _{OH} : 3.5VDC (V _{CC} = 5VDC, I _{OH} = 0.4mA)	V _{OH} : 3.5VDC (V _{CC} =5VDC, I _{OH} =0.4mA)	○	
Maximum voltage drop at ON		V _{OL} : 0.2VDC (I _{OL} = 16mA)	V _{OL} : 0.3VDC	△	Check the input specifications of an external equipment to be connected since the maximum voltage drop is bigger when turning on.
Response time	OFF to ON	1ms or less	0.5ms or less	○	
	ON to OFF	1ms or less	0.5ms or less (resistive load)	○	
Common terminal arrangement		32 points/common (Common terminal: 1A1, 1A2, 2A1, 2A2)	32 points/common (Common terminal: A01, A02)	○	
Operation indication		ON indication (LED)	ON indication (LED)	○	
Fuse		None	1.6A (Unchangeable) (Fuse blow capacity: 50A)	○	
Fuse blow indicator		–	Yes (When fuse is blows, LED indicates it signal is output to CPU.)	○	
External connection method		Two 40-pin connectors (Solder)	40-pin connector (Option)	○	The existing external wiring can be used without change.
Applicable wire size		0.3mm ²	0.3mm ² (For A6CON1, or A6CON4)	○	
External power supply	Voltage	5/12VDC (4.5 to 15VDC)	5-12VDC (4.5 to 15VDC) (Ripple ratio within 5%)	○	
	Current	300mA (12VDC TYP. 1 common ON)	170mA (at 12VDC) (Max. all points ON)	○	
Current consumption		0.30A (TYP. all points ON)	0.15A (TYP. all points ON)	○	
External dimensions		250 (H) × 37.5 (W) × 106 (D) mm	98 (H) × 27.4 (W) × 90 (D) mm	△	
Weight		0.47kg	0.14kg	△	

(42) Specifications comparison between AY80 and QY80

○: Compatible, △: Partial change required, ×: Incompatible

Specification		AY80	QY80	Compat- ibility	Precautions for replacement
Number of output points		16 points	16 points	○	
Insulation method		Photocoupler	Photocoupler	○	
Rated load voltage		12/24VDC	12-24VDC	○	
Operating load voltage range		10.2 to 30VDC	10.2 to 28.8VDC	△	Voltage over 28.8VDC is not applicable.
Maximum load current		0.5A/point, 2A/common	0.5A/point, 4A/common	○	
Maximum inrush current		7A 10ms or less 3.5A 100ms or less	4A 10ms or less	△	Carefully select load for use since the inrush current value differs.
Leakage current (OFF)		0.1mA or less	0.1mA or less	○	
Maximum voltage drop at ON		1.5VDC (Max.) 0.5A	0.2VDC (TYP.) 0.5A 0.3VDC (Max.) 0.5A	○	
Response time	OFF to ON	2ms or less	1ms or less	○	
	ON to OFF	2ms or less (Resistive load)	1ms or less (Rated load, resistive load)	○	
Surge suppressor		Varistor (52 to 62V)	Zener diode	○	
Common terminal arrangement		8 points/common (Common terminal: TB9, TB19)	16 points/common (Common terminal: TB17)	△	As the common changes from two commons to a common, wiring with a different voltage for each common is not possible.
Operation indication		ON indication (LED)	ON indication (LED)	○	
Fuse		2A fast blow fuse (1 fuse/common) type	6.7A (Unchangeable) (Fuse blow capacity: 50A)	△	When a fast blow fuse is necessary, connect the fuse externally.
Fuse blow indicator		Yes (When fuse is blows, LED indicates it's signal is output to CPU.)	Yes (When fuse is blows, LED indicates it's signal is output to CPU.)	△	The QY80 does not detect fuse blown without external power supply.
External connection method		20-point terminal block connector (M3 × 6 screws)	18-point terminal block (M3 × 6 screws)	×	Wiring change is required.*1
Applicable wire size		0.75 to 2mm ²	0.3 to 0.75mm ² core (Outside diameter: 2.8mm or less)	×	
Applicable solderless terminal		R1.25-3, R2-3, RAV1.25-3, RAV2-3	R1.25-3 (Sleeved solderless terminals cannot be used.)	×	
External power supply	Voltage	12/24VDC (10.2 to 30VDC)	12-24VDC (10.2 to 28.8VDC) (Ripple ratio within 5%)	△	Voltage over 28.8VDC is not applicable.
	Current	60mA (24VDC TYP. 1 common ON)	20mA (at 24VDC)	○	
Current consumption		0.115A (TYP. all points ON)	0.08A (TYP. all points ON)	○	
External dimensions		250 (H) × 37.5 (W) × 121 (D) mm	98 (H) × 27.4 (W) × 90 (D) mm	△	Wiring space is narrow.
Weight		0.42kg	0.17kg	△	

*1 The wiring change is not required by using the conversion adapter (ERNT-AQTY80) manufactured by Mitsubishi Electric Engineering Co., Ltd.

(43) Specifications comparison between AY80EP and QY80

○: Compatible, △: Partial change required, ×: Incompatible

Specification		AY80EP	QY80	Compat- ibility	Precautions for replacement
Number of output points		16 points	16 points	○	
Insulation method		Photocoupler	Photocoupler	○	
Rated load voltage		12/24VDC	12-24VDC	○	
Operating load voltage range		10.2 to 26.4VDC	10.2 to 28.8VDC	○	
Maximum load current		0.8A/points 0.8A/point (60% ON, 55°C) ^{*1}	0.5A/point, 4A/common	△	Carefully select load for use since the maximum load current per point is lowered.
Maximum inrush current		No limit (short-circuit protection function)	4A 10ms or less	△	Carefully select load for use since the inrush current value differs.
Leakage current (OFF)		1mA or less	0.1mA or less	○	
Maximum voltage drop at ON		1.1VDC (TYP.) 0.8A 1.50VDC (Max.) 0.8A	0.2VDC (TYP.) 0.5A 0.3VDC (Max.) 0.5A	○	
Response time	OFF to ON	0.5ms or less	1ms or less	△	Response time differs.
	ON to OFF	1.5ms or less	1ms or less (Rated load, resistive load)	△	
Surge suppressor		Surge suppression diode	Zener diode	○	
Common terminal arrangement		8 points/common (Common terminal: TB9, TB19)	16 points/common (Common terminal: TB17)	△	As the common changes from two commons to a common, wiring with a different voltage for each common is not possible.
Operation indication		ON indication (LED)	ON indication (LED)	○	
Protection function		Yes (Overheat protection function, short-circuit protection function) • Overheat protection function is activated in units of 2 points.	None	△	The protection function changes the overheat protection function and overload protection function into a fuse.
Protection detection display		Yes (LED is turned ON when overheat protection and overload protection occur. Signal is output to a CPU module.)			
Protection reset method		Automatic reset (Reset by canceling Overheat protection func.)			
Fuse		None	6.7A (Unchangeable) (Fuse blow capacity: 50A)	△	
Fuse blow indicator		—	Yes (LED is turned ON when fuse is blown. Signal is output to a CPU module.)	△	
External connection method		20-point terminal block connector (M3 × 6 screws)	18-point terminal block (M3 × 6 screws)	×	Wiring change is required.
Applicable wire size		0.75 to 2mm ² (Applicable tightening torque: 68.6N•cm)	0.3 to 0.75mm ² core (Outside diameter: 2.8mm or less)	×	
Applicable solderless terminal		R1.25-3, R2-3 RAV1.25-3, RAV2-3	R1.25-3 (Sleeved solderless terminals cannot be used.)	×	
External power supply	Voltage	12/24VDC (10.2 to 26.4VDC)	12-24VDC (10.2 to 28.8VDC) (Ripple ratio within 5%)	○	
	Current	110mA (24VDC TYP. /common)	20mA (at 24VDC)		
Current consumption		115mA (TYP. all points ON)	0.08A (TYP. all points ON)	○	
External dimensions		250 (H) × 37.5 (W) × 121 (D) mm	98 (H) × 27.4 (W) × 90 (D) mm	△	Wiring space is narrow.
Weight		0.55kg	0.17kg	△	

*1 The following shows the derating chart.

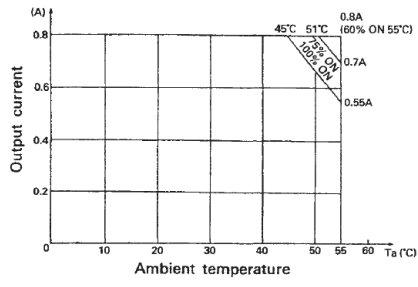

(44) Specifications comparison between AY81 and QY80

○: Compatible, △: Partial change required, ×: Incompatible

Specification		AY81	QY80	Compat- ibility	Precautions for replacement
Number of output points		32 points	16 points	△	Use two QY80s when using 17 points or more.*1
Insulation method		Photocoupler	Photocoupler	○	
Rated load voltage		12/24VDC	12-24VDC	○	
Operating load voltage range		10.2 to 30VDC	10.2 to 28.8VDC	△	Voltage over 28.8VDC is not applicable.
Maximum load current		0.5A/point, 4A/common (When placing next to the power supply module: 3A/common)	0.5A/point, 4A/common	○	
Maximum inrush current		4A 10ms or less	4A 10ms or less	○	
Leakage current (OFF)		0.1mA or less	0.1mA or less	○	
Maximum voltage drop at ON		1.5VDC (Max.) 0.5A	0.2VDC (TYP.) 0.5A 0.3VDC (Max.) 0.5A	○	
Response time	OFF to ON	2ms or less	1ms or less	○	
	ON to OFF	2ms or less (Resistive load)	1ms or less (Rated load, resistive load)	○	
Surge suppressor		Varistor (52 to 62V)	Zener diode	○	
Common terminal arrangement		16 points/common (Common terminal: TB17, TB35)	16 points/common (Common terminal: TB17)	○	
Operation indication		ON indication (LED)	ON indication (LED)	○	
Fuse		None	6.7A (Unchangeable) (Fuse blow capacity: 50A)	○	
Fuse blow indicator		-	Yes (When fuse is blows, LED indicates it's signal is output to CPU module.)		
External connection method		38-point terminal block connector (M3 × 6 screws)	18-point terminal block (M3 × 6 screws)	×	Wiring change is required.*1
Applicable wire size		0.75 to 2mm ²	0.3 to 0.75mm ² core (Outside diameter: 2.8mm or less)	×	
Applicable solderless terminal		R1.25-3, R2-3, RAV1.25-3, RAV2-3	R1.25-3 (Sleeved solderless terminals cannot be used.)	×	
External power supply	Voltage	12/24VDC (10.2 to 30VDC)	12-24VDC (10.2 to 28.8VDC) (Ripple ratio within 5%)	△	Voltage over 28.8VDC is not applicable.
	Current	50mA (24VDC TYP. 1 common ON)	20mA (at 24VDC)	○	
Current consumption		0.23A (TYP. all points ON)	0.08A (TYP. all points ON)	○	
External dimensions		250 (H) × 37.5 (W) × 131 (D) mm	98 (H) × 27.4 (W) × 90 (D) mm	△	Wiring space is narrow.
Weight		0.53kg	0.17kg	△	

*1 The wiring change is not required by using the conversion adapter (ERNT-AQTY51) manufactured by Mitsubishi Electric Engineering Co., Ltd. However, the two slot type conversion adapter cannot be used on the Q series large type base unit.

(45) Specifications comparison between AY81 and QY81P

○: Compatible, △: Partial change required, ×: Incompatible

Specification		AY81	QY81P	Compat- ibility	Precautions for replacement
Number of output points		32 points	32 points	○	
Insulation method		Photocoupler	Photocoupler	○	
Rated load voltage		12/24VDC	12-24VDC	○	
Operating load voltage range		10.2 to 30VDC	10.2 to 28.8VDC	△	Voltage over 28.8VDC is not applicable.
Maximum load current		0.5A/point, 4A/common (When placing next to the power supply module: 3A/common)	0.1A/point, 2A/common	△	Carefully select load for use since the maximum load current per point is lowered.
Maximum inrush current		4A 10ms or less	0.7A 10ms or less	△	Carefully select load for use since the inrush current value differs.
Leakage current (OFF)		0.1mA or less	0.1mA or less	○	
Maximum voltage drop at ON		1.5VDC (Max.) 0.5A	0.1VDC (TYP.) 0.1A 0.2VDC (Max.) 0.1A	○	
Response time	OFF to ON	2ms or less	1ms or less	○	
	ON to OFF	2ms or less (Resistive load)	1ms or less (Rated load, resistive load)	○	
Common terminal arrangement		16 points/common (Common terminal: TB17, TB35)	32 points/common (Common terminal: 17, 18, 36)	△	As the common changes from two commons to a common, wiring with a different voltage for each common is not possible.
Surge suppressor		Varistor (52 to 62V)	Zener diode	○	
Operation indication		ON indication (LED)	ON indication (LED)	○	
Protection function		None	Yes (Overheat protection function, overload protection function.) • Overheat protection function is activated in units of 2 points. • Overload protection function is activated in units of 1 point.	○	
External connection method		38-point terminal block connector (M3 × 6 screws)	37-pin D-subconnector (Option)	×	Wiring change is required. *1
Applicable wire size		0.75 to 2mm ²	0.3mm ² (For A6CON1E)	×	
Applicable solderless terminal		R1.25-3, R2-3, RAV1.25-3, RAV2-3	-	×	
External power supply	Voltage	12/24VDC (10.2 to 30VDC)	12-24VDC (10.2 to 28.8VDC) (Ripple ratio within 5%)	△	Voltage over 28.8VDC is not applicable.
	Current	50mA (24VDC TYP. 1 common ON)	40mA (At 24VDC)	○	
Current consumption		0.23A (TYP. all points ON)	0.095A (TYP. all points ON)	○	
External dimensions		250 (H) × 37.5 (W) × 131 (D) mm	98 (H) × 27.4 (W) × 90 (D) mm	△	
Weight		0.53kg	0.15kg	△	

*1 The wiring change is not required by using the conversion adapter (ERNT-AQTY81) manufactured by Mitsubishi Electric Engineering Co., Ltd. By using connectors/terminal block converter modules such as the A6TBXY36-E and the conversion module such as the FA-TB32XY, conversion to the terminal block is possible.

(46) Specifications comparison between AY81EP and QY80

○: Compatible, △: Partial change required, ×: Incompatible

Specification		AY81EP	QY80	Compat- ibility	Precautions for replacement
Number of output points		32 points	16 points	△	Use two QY80s when using 17 points or more. *1
Insulation method		Photocoupler	Photocoupler	○	
Rated load voltage		12/24VDC	12-24VDC	○	
Operating load voltage range		10.2 to 26.4VDC	10.2 to 28.8VDC	○	
Maximum load current		0.8A/points 0.4A/point (60% ON, 55°C)	0.5A/point, 4A/common	△	Carefully select load for use since the maximum load current per point is lowered.
Maximum inrush current		No limit (short-circuit protection function)	4A 10ms or less	△	Carefully select load for use since the inrush current value differs.
Leakage current (OFF)		1mA or less	0.1mA or less	○	
Maximum voltage drop at ON		1.1VDC (TYP.) 0.8A 1.5VDC (Max.) 0.8A	0.2VDC (TYP.) 0.5A 0.3VDC (Max.) 0.5A	○	
Response time	OFF to ON	0.5ms or less	1ms or less	○	
	ON to OFF	1.5ms or less	1ms or less (Rated load, resistive load)	○	
Surge suppressor		Surge suppression diode	Zener diode	○	
Common terminal arrangement		16 points/common (Common terminal: TB17, TB35)	16 points/common (Common terminal: TB17)	○	
Operation indication		ON indication (LED)	ON indication (LED)	○	
Fuse		None	Yes (When fuse is blows, LED indicates it's signal is output to CPU module.)	△	The protection function changes the short-circuit protection function into a fuse.
Protection function		Yes (Overheat protection function, short-circuit protection function) • Overheat protection function is activated in units of 2 points.	None		
External connection method		38-point terminal block connector (M3 × 6 screws)	18-point terminal block (M3 × 6 screws)	×	Wiring change is required. *1
Applicable wire size		0.75 to 2mm ²	0.3 to 0.75mm ² core (Outside diameter: 2.8mm or less)	×	
Applicable solderless terminal		R1.25-3, R2-3 RAV1.25-3, RAV2-3	R1.25-3 (Sleeved solderless terminals cannot be used.)	×	
External power supply	Voltage	12/24VDC (10.2 to 26.4VDC)	12-24VDC (10.2 to 28.8VDC) (Ripple ratio within 5%)	○	
	Current	220mA (24VDC TYP. /common)	20mA (at 24VDC)	○	
Current consumption		0.23mA (TYP. all points ON)	0.08A (TYP. all points ON)	○	
External dimensions		250 (H) × 37.5 (W) × 131 (D) mm	98 (H) × 27.4 (W) × 90 (D) mm	△	Wiring space is narrow.
Weight		0.72kg	0.17kg	△	

*1 The wiring change is not required by using the conversion adapter (ERNT-AQTY51) manufactured by Mitsubishi Electric Engineering Co., Ltd. However, the two slot type conversion adapter cannot be used on the Q series large type base unit.

(47) Specifications comparison between AY81EP and QY81P

○: Compatible, △: Partial change required, ×: Incompatible

Specification		AY81EP	QY81P	Compat- ibility	Precautions for replacement
Number of output points		32 points	32 points	○	
Insulation method		Photocoupler	Photocoupler	○	
Rated load voltage		12/24VDC	12-24VDC	○	
Operating load voltage range		10.2 to 26.4VDC	10.2 to 28.8VDC	○	
Maximum load current		0.8A/points 0.4A/point (60% ON, 55°C)	0.1A/point, 2A/common	△	Carefully select load for use since the maximum load current per point is lowered.
Maximum inrush current		No limit (short-circuit protection function)	0.7A to 10ms or less	△	Carefully select load for use since the inrush current value differs.
Leakage current (OFF)		1mA or less	0.1mA or less	○	
Maximum voltage drop at ON		1.1VDC (TYP.) 0.8A 1.5VDC (Max.) 0.8A	0.1VDC (TYP.) 0.1A 0.2VDC (Max.) 0.1A	○	
Response time	OFF to ON	0.5ms or less	1ms or less	△	Response time differs.
	ON to OFF	1.5ms or less	1ms or less (Rated load, resistive load)	△	
Common terminal arrangement		16 points/common (Common terminal: TB17, TB35)	32 points/common (Common terminal: 17, 18, 36)	△	As the common changes from two commons to a common, wiring with a different voltage for each common is not possible.
Surge suppressor		Surge suppression diode	Zener diode	○	
Operation indication		ON indication (LED)	ON indication (LED)	○	
Protection function		Yes (Overheat protection function, short-circuit protection function) • Overheat protection function is activated in units of 2 points.	Yes (Overheat protection function, overload protection function.) • Overheat protection function is activated in units of 2 points. • Overload protection function is activated in units of 1 point.	○	
External connection method		38-point terminal block connector (M3 × 6 screws)	37-pin D-subconnector (Option)	×	Wiring change is required.*1
Applicable wire size		0.75 to 2mm ²	0.3mm ² (For A6CON1E)	×	
Applicable solderless terminal		R1.25-3, R2-3 RAV1.25-3, RAV2-3	-	×	
External power supply	Voltage	12/24VDC (10.2 to 26.4VDC)	12-24VDC (10.2 to 28.8VDC) (Ripple ratio within 5%)	△	Voltage over 28.8VDC is not applicable.
	Current	220mA (24VDC TYP. /common)	40mA (at 24VDC)	○	
Current consumption		0.23mA (TYP. all points ON)	0.095A (TYP. all points ON)	○	
External dimensions		250 (H) × 37.5 (W) × 131 (D) mm	98 (H) × 27.4 (W) × 90 (D) mm	△	
Weight		0.72kg	0.15kg	△	

*1 The wiring change is not required by using the conversion adapter (ERNT-AQTY81) manufactured by Mitsubishi Electric Engineering Co., Ltd. By using connectors/terminal block converter modules such as the A6TBXY36-E and the conversion module such as the FA-TB32XY, conversion to the terminal block is possible.

(48) Specifications comparison between AY82EP and QY81P

○: Compatible, △: Partial change required, ×: Incompatible

Specification		AY82EP	QY81P	Compat- ibility	Precautions for replacement
Number of output points		64 points	32 points	△	Use two QY81Ps when using 33 points or more.
Insulation method		Photocoupler	Photocoupler	○	
Rated load voltage		12/24VDC	12-24VDC	○	
Operating load voltage range		10.2 to 26.4VDC	10.2 to 28.8VDC	○	
Maximum load current		0.1A/point 0.04A/point (60% ON, 55 °C)	0.1A/point, 2A/common	○	
Maximum inrush current		No limit (short-circuit protection function)	0.7A to 10ms or less	△	Carefully select load for use since the inrush current value differs.
Leakage current (OFF)		0.1mA or less	0.1mA or less	○	
Maximum voltage drop at ON		3.5VDC (0.1A) 2.5VDC (0.1A TYP.)	0.1VDC (TYP.) 0.1A 0.2VDC (Max.) 0.1A	○	
Response time	OFF to ON	0.5ms or less	1ms or less	△	Response time differs.
	ON to OFF	1.5ms or less	1ms or less (Rated load, resistive load)	△	
Common terminal arrangement		32 points/common (Common terminal: 1-17, 1-18, 1-36, 2-17, 2-18, 2-36)	32 points/common (Common terminal: 17, 18, 36)	○	
Surge suppressor		Surge suppression diode	Zener diode	○	
Operation indication		ON indication (LED)	ON indication (LED)	○	
Protection function		Yes (Overheat protection function, and short-circuit protection function.) • Overheat protection func. is detected in 1 point unit. When Overheat protection func. occurs at an 1 point of 1 common, output of all points for corresponded common terminal is turned. OFF.	Yes (Overheat protection function, overload protection function.) • Overheat protection function is activated in units of 2 points. • Overload protection function is activated in units of 1 point.	○	
Protection function detection display		None (No signal output to CPU module.)	None (No signal output to CPU module.)	○	
Protection reset method		Automatic reset (Reset by canceling Overheat protection func.)	Automatic reset (Reset by canceling Overheat protection func.)	○	
External connection method		Two 37-pin connectors (Solder)	37-pin D-subconnector (Option)	△	If you are using the connector included with the AY82EP, you must to replace the connector shell of the A6CON1E (solder).
Applicable wire size		0.3mm ²	0.3mm ² (For A6CON1E)	○	
External power supply	Voltage	12/24VDC (10.2 to 30VDC)	12-24VDC (10.2 to 28.8VDC) (Ripple ratio within 5%)	△	Voltage of 28.8VDC or more is not allowed.
	Current	50mA (24VDC TYP. 1 common ON)	40mA (at 24VDC)	○	
Current consumption		0.29A (TYP. all points ON)	0.095A (TYP. all points ON)	○	
External dimensions		250 (H) × 37.5 (W) × 106 (D) mm	98 (H) × 27.4 (W) × 90 (D) mm	△	
Weight		0.58kg	0.15kg	△	

(49) Specifications comparison between AY82EP and QY82P

○: Compatible, △: Partial change required, ×: Incompatible

Specification		AY82EP	QY82P	Compat- ibility	Precautions for replacement
Number of output points		64 points	64 points	○	
Insulation method		Photocoupler	Photocoupler	○	
Rated load voltage		12/24VDC	12-24VDC	○	
Operating load voltage range		10.2 to 26.4VDC	10.2 to 28.8VDC	○	
Maximum load current		0.1A/point 0.04A/point (60%ON, 55 °C)	0.1A/point, 2A/common	○	
Maximum inrush current		No limit (short-circuit protection function)	0.7A to 10ms or less	△	Carefully select load for use since the inrush current value differs.
Leakage current (OFF)		0.1mA or less	0.1mA or less	○	
Maximum voltage drop at ON		3.5VDC (0.1A) 2.5VDC (0.1A TYP.)	0.1VDC (TYP.) 0.1A 0.2VDC (Max.) 0.1A	○	
Response time	OFF to ON	0.5ms or less	1ms or less	△	Response time differs.
	ON to OFF	1.5ms or less	1ms or less (Rated load, resistive load)	△	
Common terminal arrangement		32 points/common (Common terminal: 1-17, 1-18, 1-36, 2-17, 2-18, 2-36)	32 points/common (Common terminal: 1B01, 1B02, 2B01, 2B02)	×	Wiring change is required.
Surge suppressor		Surge suppression diode	Zener diode	○	
Operation indication		ON indication (LED)	ON indication (LED) 32 point switch-over using switch	○	
Protection function		Yes (Overheat protection function, and short-circuit protection function.) • Overheat protection func. is detected in 1 point unit. When Overheat protection func. occurs at an 1 point of 1 common, output of all points for corresponded common terminal is turned OFF.	Yes (Overheat protection function, overload protection function.) • Overheat protection function is activated in units of 2 points. • Overload protection function is activated in units of 1 point.	○	
External connection method		Two 37-pin connectors (Solder)	40-pin connector (Option)	×	Wiring change is required.
Applicable wire size		0.3mm ²	0.3mm ² (For A6CON1)	×	
External power supply	Voltage	12/24VDC (10.2 to 30VDC)	12-24VDC (10.2 to 28.8VDC) (Ripple ratio within 5%)	△	Voltage over 28.8VDC is not applicable.
	Current	50mA (24VDC TYP. 1 common ON)	40mA (at 24VDC)/common	○	
Current consumption		0.29A (TYP. all points ON)	0.095A (TYP. all points ON)	○	
External dimensions		250 (H) × 37.5 (W) × 106 (D) mm	98 (H) × 27.4 (W) × 90 (D) mm	△	
Weight		0.58kg	0.15kg	△	

3.2.3 I/O combined module specifications comparison

(1) Specifications comparison between AH42 and QH42P

○: Compatible, △: Partial change required, ×: Incompatible

Specification		AH42	QH42P	Compat- ibility	Precautions for replacement	
Input specifications	Number of input points	32 points	32 points	○		
	Insulation method	Photocoupler	Photocoupler	○		
	Input type	Sink type	Sink type (Positive common)	○		
	Operating voltage range	10.2 to 26.4VDC (Ripple ratio within 5%)	20.4 to 28.8VDC (Ripple ratio within 5%)	△	12VDC are not applicable.	
	Rated input current	Approx. 3mA (at 12VDC)/ Approx. 7mA (at 24VDC)	Approx. 4mA	△	Reduced. *1	
	Maximum number of simultaneous input points	60% Simultaneously ON	Refer to the derating chart. *2	○		
	ON voltage/ON current	9.5VDC or more/3mA or more	19VDC or more/3mA or more	△	12VDC are not applicable.	
	OFF voltage/OFF current	6VDC or less/1.5mA or less	11VDC or less/1.7mA or less	△	12VDC are not applicable.	
	Input resistance	Approx. 3.3kΩ	Approx. 5.6kΩ	△	Input resistance has increased. *1	
	Response time	OFF to ON	10ms or less (24VDC)	1ms/5ms/10ms/20ms /70ms or less (CPU parameter setting) initial setting is 10ms	○	Use initial value (10ms) for the input response time of parameters.
		ON to OFF	10ms or less (24VDC)	1ms/5ms/10ms/20ms /70ms or less (CPU parameter setting) initial setting is 10ms	○	Use initial value (10ms) for the input response time of parameters.
Common terminal arrangement		32 points/common (Common terminal: 1B1, 1B2)	32 points/common (Common terminal: 1B01, 1B02)	○		
Output specifications	Number of output points	32 points	32 points	○	Output number (Y □) differs. *3	
	Insulation method	Photocoupler	Photocoupler	○		
	Output type	Sink type	Sink type	○		
	Rated load voltage	10.2 to 40VDC	10.2 to 28.8VDC	△	Voltage over 28.8VDC is not applicable.	
	Maximum load current	0.1A/1point, 1A/common	0.1A/1 point, 2A/common	○		
	Max. inrush current	0.4A 10ms or less	0.7A 10ms or less	○		
	Leakage current (OFF)	0.1mA or less	0.1mA or less	○		
	Maximum voltage drop at ON	2.5VDC (0.1A) 1.75VDC (5mA) 1.7VDC (1mA)	0.1VDC (TYP.) 0.1A 0.2VDC (Max.) 0.1A	○		
	Response time	OFF to ON	2ms or less	1ms or less	○	
		ON to OFF (Resistive load)	2ms or less (Resistive load)	1ms or less (Rated load, resistive load)	○	
	Surge suppressor		Clamp diode	Zener diode	○	
	Common terminal arrangement		32 points/common (Common terminal: 2A1, 2A2)	32 points/common (Common terminal: 2A01, 2A02)	○	
	External power supply	Voltage	12/24VDC (10.2 to 40VDC)	12-24VDC (10.2 to 28.8VDC Ripple ratio within 5%)	△	Voltage over 28.8VDC is not applicable.
Current		0.04A (24VDC TYP.)	0.015A (24VDC)/common (Max. all points ON)	○		
Operation indication		ON indication (LED) 32 point switch-over using switch	ON indication (LED) 32 point switch-over using switch	○		

Specification	AH42	QH42P	Compat- ibility	Precautions for replacement
External connection method	40 pin connector × 2	40 pin connector × 2 (Option)	○	The existing external wiring can be used without change.
Applicable wire size	0.3mm ²	0.3mm ² (For A6CON1 or A6CON4)	○	
Number of occupied points	64 points (I/O assignment: output 64 points)	32 points (I/O assignment: input/output composite)	×	Output number (Y □) differs. *3
Current consumption	0.25A (TYP. all points ON)	0.13A (TYP. all points ON)	○	
External dimensions	250 (H) × 37.5 (W) × 121 (D) mm	98 (H) × 27.4 (W) × 90 (D) mm	△	Wiring space is narrow.
Weight	0.70kg	0.20kg	△	

*1 Check the specifications of the sensor or switches to be connected to the QH42P.

*2 The following shows the derating chart.

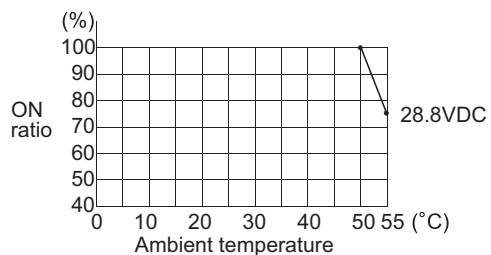

*3 Modify the output number used in the program. (Review the programs)

(2) Specifications comparison between AH42 and QX41Y41P

○: Compatible, △: Partial change required, ×: Incompatible

Specifications		AH42	QX41Y41P	Compat- ibility	Precautions for replacement	
Input specifications	Number of input points	32 points	32 points	○		
	Insulation method	Photocoupler	Photocoupler	○		
	Input format	Sink type	Positive common type	○		
	Operating voltage range	10.2 to 26.4VDC (Ripple ratio within 5%)	20.4 to 28.8VDC (Ripple ratio within 5%)	△	12VDC cannot be used.	
	Rated input current	Approx.3mA (at 12VDC)/ Approx.7mA (at 24VDC)	Approx.4mA	△	Rated input current is smaller. *1	
	Maximum number of simultaneous input points	60% simultaneously ON	Refer to the derating chart. *3	○		
	ON voltage/ON current	9.5VDC or more/3mA or more	19VDC or more/3mA or more	△	12VDC cannot be used.	
	OFF voltage/OFF current	6VDC or less/1.5mA or less	11VDC or less/1.7mA or less	△	12VDC cannot be used.	
	Input resistance	Approx.3.3k Ω	Approx.5.6k Ω	△	Input resistance is greater. *2	
	Response time	OFF→ON	10ms or less (24VDC)	1ms/5ms/10ms/20ms /70ms or less (CPU parameter setting) Initial setting is 10ms.	○	Input response time of the parameter must be used at the initial value (10ms).
		ON→OFF	10ms or less (24VDC)	1ms/5ms/10ms/20ms /70ms or less (CPU parameter setting) Initial setting is 10ms.	○	Input response time of the parameter must be used at the initial value (10ms).
	Common terminal arrangement		32 points/common (Common terminal: 1B1,1B2)	32 points/common (Common terminal: 1B01,1B02)	○	
Output specifications	Number of output points	32 points	32 points	○		
	Insulation method	Photocoupler	Photocoupler	○		
	Output format	Sink type	Sink type	○		
	Rated load voltage	10.2 to 40VDC	10.2 to 28.8VDC	△	Voltages exceeding 28.8VDC cannot be applied.	
	Maximum load current	0.1A/point, 1A/common	0.1A/point, 2A/common	○		
	Maximum inrush current	0.4A 10ms or less	0.7A 10ms or less	○		
	Leakage current at OFF	0.1mA or less	0.1mA or less	○		
	Maximum voltage drop at ON	2.5VDC (0.1A) 1.75VDC (5mA) 1.7VDC (1mA)	0.1VDC (TYP.) 0.1A 0.2VDC (Max.) 0.1A	○		
	Response time	OFF→ON	2ms or less	1ms or less	○	
		ON→OFF	2ms or less (Resistance load)	1ms or less (Rated load, Resistance load)	○	
	Surge suppressor		Clamp diode	Zener diode	○	
	Common terminal arrangement		32 points/common (Common terminal: 2A1, 2A2)	32 points/common (Common terminal: 2A01, 2A02)	○	
	External power supply	voltage	12/24VDC (10.2 to 40VDC)	12 to 24VDC (+20/-15%) (Ripple ratio within 5%)	△	Voltages exceeding 28.8VDC cannot be applied.
		current	0.04A (24VDC TYP.)	Max.0.015A/common (24VDC, when all points are ON)	○	
	Operation indication		ON indication (LED) 32-point switching indication with SW	ON indication (LED) 32-point switching indication with SW	○	
External connection method		40-pin connector × 2	40-pin connector × 2 (sold separately)	○	The existing external wiring can be used without change.	
Applicable wire size		0.3mm ²	0.3mm ² (For A6CON1 or A6CON4)	○		
Number of occupied points		64 points (I/O assignment: Output 64 points)	64 points (I/O assignment: I/O mix 64 points)	○		
Current consumption		0.25A (TYP.all points ON)	0.13A (TYP.all points ON)	○		
External dimensions		250(H) × 37.5(W) × 121(D) mm	98(H) × 27.4(W) × 90(D) mm	△		
Weight		0.70kg	0.20kg	△		

- *1 Use the QX71 at 12VDC.
- *2 Check the specifications of the sensor or switches to be connected to the QX41Y41P.
- *3 The following shows the derating chart.

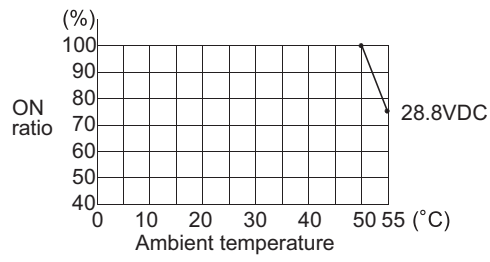

(3) Specifications comparison between A42XY and QX42/QY42P

(a) Specifications comparison between A42XY (input part) and QX42

○: Compatible, △: Partial change required, ×: Incompatible

Specification		A42XY (input specification)	QX42	Compat- ibility	Precautions for replacement
Number of input points		64 points	64 points	○	
Insulation method		Photocoupler	Photocoupler	○	
input type		Dynamic scan of 8 inputs × 8	Static	×	Set the static.
Rated input voltage		12/24VDC (10.2 to 26.4VDC) (Ripple ratio within 5%)	24VDC (20.4 to 28.8VDC) (Ripple ratio within 5%)	○	
Maximum number of simultaneous input points		60% Simultaneously ON	Refer to the derating chart.*1	△	Use within the range shown in the derating figure.
ON voltage/ON current		7VDC or more	19VDC or more/3mA or more	△	12VDC are not applicable.
OFF voltage/OFF current		3VDC or more	11VDC or less/1.7mA or less	△	12VDC are not applicable.
Input resistance		Approx. 2.4kΩ	Approx. 5.6kΩ	△	Input resistance has increased.*2
Response time	OFF to ON	16ms or less	1ms/5ms/10ms/20ms /70ms or less (CPU parameter setting) initial setting is 10ms	○	Use initial value (10ms) for the input response time of parameters.
	ON to OFF	16ms or less	1ms/5ms/10ms/20ms /70ms or less (CPU parameter setting) initial setting is 10ms	○	Use initial value (10ms) for the input response time of parameters.
Common terminal arrangement		–	32 points/common (Common terminal: 1B01, 1B02, 2B01, 2B02)	–	
Operation indication		ON indication (LED) Batch of 8 inputs selected by rotary switch	ON indication (LED) 32 point switch-over using switch	○	
External connection method		input: 16 pin connector	40 pin connector	×	Wiring change is required.
Applicable wire size		0.3mm ²	0.3mm ² (For A6CON1 or A6CON4)	○	
External power supply	Voltage	12/24VDC (10.2 to 26.4VDC) (Ripple ratio within 5%)	–	○	External power supply is not required.
	Current	55mA TYP.	–		
Number of occupied points		64 points (Output I/O assignment: 64 points)	64 points (I/O assignment: input)	○	The number of occupied points is 128 points (64points × 2 = 128 points) when using both modules of the QX42 and QY42.
Current consumption		0.11A TYP.	0.09A (TYP. all points ON)	○	
External dimensions		250 (H) × 37.5 (W) × 119 (D) mm	98 (H) × 27.4 (W) × 90 (D) mm	△	
Weight		0.60kg	0.18kg	△	

*1 The following shows the derating chart.

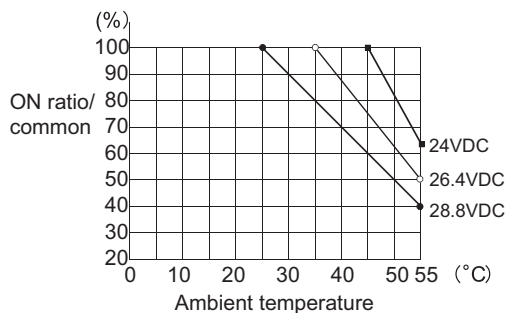

*2 Check the specifications of the sensor or switches to be connected to the QX40.

(b) Specifications comparison between A42XY (output part) and QY42P

○: Compatible, △: Partial change required, ×: Incompatible

Specification		A42XY (Output specification)	QY42P	Compat- ibility	Precautions for replacement
Number of output points		64 points	64 points	○	
Insulation method		Photocoupler	Photocoupler	○	
Output type		Dynamic scan of 8 inputs × 8	Static	×	Set the static.
Rated load voltage		12/24VDC (10.2 to 26.4VDC) (Ripple ratio within 5%)	12/24VDC (10.2 to 28.8VDC)	○	
Max. output current		50mA per point (Built in limiting resistor (1kΩ) not used)	0.1A/point, 2A/common	○	
Max. voltage drop at ON		1.5V on the source side (Built in limiting resistor not used) 1V on the sink side	0.1VDC (TYP.) 0.1A 0.2VDC (Max.) 0.1A	○	
Max. simultaneously ON		Built in limiting resistor (1kΩ) not used	100% simultaneously ON (50mA/point)	○	
Response time	OFF to ON	16ms or less	1ms or less	○	
	ON to OFF	16ms or less	1ms or less (Rated load, resistive load)	○	
Common terminal arrangement		–	32 points/common (Common terminal: 1A01, 1A02, 2A01, 2A02)	○	
Operation indication		ON indication (LED) Batch of 8 inputs selected by rotary switch	ON indication (LED) 32 point switch-over using switch	○	
External connection method		Output: 32 pin connector	40 pin connector	×	Wiring change is required.
Applicable wire size		0.3mm ²	0.3mm ² (For A6CON1 or A6CON4)	○	
External power supply	Voltage	12/24VDC (10.2 to 26.4VDC) (Ripple ratio within 5%)	12-24VDC (10.2 to 28.8VDC) (Ripple ratio within 5%)	○	
	Current	180mA TYP.	0.02A (24VDC)/common	○	
Number of occupied points		64 points (I/O assignment: output 64 points)	64 points (I/O assignment: output)	○	The number of occupied points is 128 points (64points × 2 = 128 points) when using both modules of the QX42 and QY42.
Current consumption		0.11A TYP.	0.15A (TYP. all points ON)	△	Reviewing power supply capacity is required.
External dimensions		250 (H) × 37.5 (W) × 119 (D) mm	98 (H) × 27.4 (W) × 90 (D) mm	△	
Weight		0.60kg	0.17kg	△	

3.2.4 Interrupt module specifications comparison

(1) Specifications comparison between AI61 and QI60

○: Compatible, △: Partial change required, ×: Incompatible

Specification		AI61	QI60	Compat- ibility	Precautions for replacement
Number of interrupt input points		16 points	16 points	○	
Insulation method		Photocoupler	Photocoupler	○	
Rated input voltage		12VDC/24VDC	24VDC	△	12VDC are not applicable.
Rated input current		6mA (12VDC) 14mA (24VDC)	Approx. 6mA	△	Reduced. *1
Operating voltage range		10.2 to 26.4VDC	20.4 to 28.8VDC (Ripple ratio within 5%)	△	12VDC are not applicable.
Maximum number of simultaneous input points		100% Simultaneously ON	100% Simultaneously ON	○	
ON voltage		9VDC or more	19VDC or more/4.0mA or more	△	12VDC are not applicable.
OFF voltage		4VDC or less	11VDC or less/1.7mA or less	△	12VDC are not applicable.
Input resistance		Approx. 2.4kΩ	Approx. 3.9kΩ	△	Input resistance has increased. *1
Response time	OFF to ON	0.2ms or less	0.1ms/0.2ms/0.4ms/0.6ms /1ms or less (CPU parameter setting) Initial setting is 0.2ms	○	Use initial value (0.2ms) for the input response time of parameters.
	ON to OFF	0.2ms or less	0.1ms/0.2ms/0.4ms/0.6ms/1ms or less (CPU parameter setting) Initial setting is 0.2ms	○	Use initial value (0.2ms) for the input response time of parameters.
Common terminal arrangement		16 points/common (Common terminal: TB9, TB18)	16 points/common (Common terminal: TB17)	○	
Operation indication		ON indication (LED)	ON indication (LED)	○	
External connection method		20-point terminal block connector (M3 × 6 screws)	18-point terminal block (M3 × 6 screws)	×	Wiring change is required.
Applicable wire size		0.75 to 1.5mm ²	0.3 to 0.75mm ² core (Outside diameter: 2.8mm or less)	×	
Applicable solderless terminal		1.25-3, 1.25-YS3A, 2-S3, 2-YS3A, V1.25-3, V1.25-YS3A, V2-S3, V2-YS3A	R1.25-3 (Sleeved solderless terminals cannot be used.)	×	
Number of occupied points		32 points (I/O assignment: Intelligent 32 points)	16 points (I/O assignment: Interrupt)	×	I/O assignment differs.
Current consumption		0.14A (TYP. all points ON)	0.06A (TYP. all points ON)	○	
External dimensions		250 (H) × 37.5 (W) × 121 (D) mm	98 (H) × 27.4 (W) × 90 (D) mm	△	Wiring space is narrow.
Weight		0.40kg	0.20kg	△	

*1 Check the specifications of the sensor or switch to be connected to the QI60.

(2) Specifications comparison between AI61-S1 and QI60

○: Compatible, △: Partial change required, ×: Incompatible

Specification		AI61-S1	QI60	Compat- ibility	Precautions for replacement
Number of interrupt input points		16 points	16 points	○	
Insulation method		Photocoupler	Photocoupler	○	
Rated input voltage		24VDC	24VDC	○	
Rated input current		14mA	Approx. 6mA	△	Reduced. *1
Operating voltage range		21.6 to 26.4VDC	20.4 to 28.8VDC (Ripple ratio within 5%)	○	
Maximum number of simultaneous input points		100% Simultaneously ON	100% Simultaneously ON	○	
ON voltage		16VDC or more	19VDC or more/4.0mA or more	△	The ON voltage has been increased. *1
OFF voltage		9VDC or less	11VDC or less/1.7mA or less	△	The OFF voltage has been increased. *1
Input resistance		Approx. 2.4kΩ	Approx. 3.9kΩ	△	Input resistance has increased. *1
Response time	OFF to ON	2ms or less, 8ms or less	0.1ms/0.2ms/0.4ms/0.6ms /1ms or less (CPU parameter setting) Initial setting is 0.2ms	△	Setting 2ms or more input response time in Parameter is not allowed. Set 1ms to the input response time.
	ON to OFF	2ms or less, 8ms or less	0.1ms/0.2ms/0.4ms/0.6ms /1ms or less (CPU parameter setting) Initial setting is 0.2ms	△	Setting 2ms or more input response time in Parameter is not allowed. Set 1ms to the input response time.
Common terminal arrangement		16 points/common (Common terminal: TB9, TB18)	16 points/common (Common terminal: TB17)	○	
Operation indication		ON indication (LED)	ON indication (LED)	○	
External connection method		20-point terminal block connector (M3 × 6 screws)	18-point terminal block (M3 × 6 screws)	×	Wiring change is required.
Applicable wire size		0.75 to 1.5mm ²	0.3 to 0.75mm ² core (Outside diameter: 2.8mm or less)	×	
Applicable solderless terminal		1.25-3, 1.25-YS3A, 2-S3, 2-YS3A, V1.25-3, V1.25-YS3A, V2-S3, V2-YS3A	R1.25-3 (Sleeved solderless terminals cannot be used.)	×	
Number of occupied points		32 points (I/O assignment: Interrupt 32 points)	16 points (I/O assignment: Intelligent)	×	I/O assignment differs.
Current consumption		0.14A (TYP. all points ON)	0.06A (TYP. all points ON)	○	
External dimensions		250 (H) × 37.5 (W) × 121 (D) mm	98 (H) × 27.4 (W) × 90 (D) mm	△	Wiring space is narrow.
Weight		0.40kg	0.20kg	△	

*1 Check the specifications of the sensor or switches to be connected to the QI60.

3.2.5 Blank cover and dummy module specifications comparison

(1) Specifications comparison between AG60 and QG60

○: Compatible, △: Partial change required, ×: Incompatible

Specification	AG60	QG60	Compat- ibility	Precautions for replacement
Number of I/O number occupied points	16 points	16 points	○	
I/O assignment classification	Empty 16 points	Empty 16 points	○	
Application	Use for parts without I/O module (Especially, for parts of empty slot between modules) as dust control.	Mounted to the slot where no I/O module is mounted (Especially between modules) for dust control.	○	
External dimensions	250 (H) × 37.5 (W) × 121 (D) mm	98 (H) × 27.4 (W) × 90 (D) mm	△	
Weight	0.17kg	0.07kg	△	

(2) Specifications comparison between AG62 and QG60

○: Compatible, △: Partial change required, ×: Incompatible

Specification	AG62	QG60	Compat- ibility	Precautions for replacement
Number of I/O number occupied points	Max. 64 points (Able to select from 16 points, 32 points, 48 points and 64 points by using the switch on module surface.)	16 points	△	Set the number of occupied points with the I/O assignment of parameter settings.
I/O assignment classification	Depends on the switch setting for the number of input occupied points (16 points, 32 points, 48 points, 64 points)	Empty 16 points	△	
Application	Reserve 16 points, 32 points, 48 points or 64 points in advance for the future need of adding I/O.	Mounted to the slot where no I/O module is mounted (Especially between modules) for dust control.	△	
Other functions	The provided simulation switches for 16 points from the first I/O number allows the input on/off without an external switch.	–	×	Configure with external switches and input modules.
Current consumption	0.07A	–	△	
External dimensions	250 (H) × 37.5 (W) × 121 (D) mm	98 (H) × 27.4 (W) × 90 (D) mm	△	
Weight	0.3kg	0.07kg	△	

3.3 Precautions for I/O Module Replacement

(1) Wiring

(a) Size of wire and crimping terminal

The module and terminal block of the Q series are smaller than the A series, therefore the applicable size of wire and crimping terminal for terminal blocks differ between the two series.

For this reason, use the wire and crimping terminal compatible with the specifications of the Q series I/O module when replacing with the Q series.

The upgrade tool (Conversion adapter) manufactured by Mitsubishi Electric Engineering Co., Ltd.* omits the procedure of changing wiring. (Connection change for power supply and common terminals is required. Also, the conversion adapter fixing plate is necessary when using the conversion adapter.)

As the Q series is a smaller model, wiring space on terminal blocks is narrower. Pay much attention in wiring.

(b) Change from terminal block to connector

The 32-point I/O modules of the A series uses terminal blocks while that of Q series uses connectors. When using a 32-point I/O module of the Q series shift to the wiring using connectors or convert the connectors to terminal blocks with the following methods.

- Use the converter module for the connectors and terminal block.
- Use the upgrade tool (Conversion adapter)* manufactured by Mitsubishi Electric Engineering Co., Ltd.

* For products manufactured by Mitsubishi Electric Engineering Co., Ltd., contact your local sales representative.

(2) Connector for external wiring

External wiring connectors are not included in a package of the 32 and 64 points I/O module of the Q series.

Purchase the necessary number of the connectors (A6CON □) separately.

(3) Precautions for input modules

(a) Specifications change of rated input current

Check the specifications of connecting devices (such as sensors and switches) since rated input current is reduced for some Q series input modules compared to that for the A series.

(b) Specifications change of OFF current

Check the specifications of sensors and switches since some of the Q series input modules support lower OFF current than those of the A series.

(c) Specifications change of maximum number of simultaneous input points

Check the specifications of sensors and switches since some of the Q series input modules have less maximum number of simultaneous input points than those of the A series.

Refer to the derating diagram and use within the range shown in the diagram when replacing with the Q series.

(d) Specifications change of rated voltage value

The QX4 □ and the QX8 □ type DC input module of the Q series are dedicated to 24VDC. Use QX7 □ at 12VDC.

(e) Specifications change of response time

For the Q series DC input modules, the I/O response time can be set with the parameter. Set the I/O response time with parameters adjusting it to the response time of the A series input module.

(f) Specifications change of common terminal arrangement

The common terminal arrangement may differ between the A series and Q series. Pay attention when applying a different voltage to each common.

(4) Precautions for output module**(a) Specifications change of output current value**

Some of the Q series output modules support lower output current than those of the A series. Check the specification of the load side when using the Q series output module with smaller output current.

(b) Specifications change of common terminal arrangement

The common terminal arrangement may differ between the A series and Q series. Pay attention when applying a different voltage to each common.

(c) Specifications change of common maximum load current

Since the maximum load current per common may differ between the A series and Q series, check them before use.

(d) Precautions when using the triac output module

Operation of the triac that is used on the triac output module may be unstable when a sudden change occurs in the voltage and current due to component characteristics.

Problems due to voltage and current fluctuation might become obvious depending on individual differences between components. For this reason, refer to the following manual and check for any corresponding items in the precautions.

- Q Series Large Type Base Unit / I/O Module / Blank Cover User's Manual
- I/O Module Type Building Block User's Manual

3.4 Q Series Large Type I/O Module Replacement

3.4.1 Q series large type I/O module specifications comparison

(1) QX11L type AC input module (specifications comparison with AX11)

Specifications		AX11 (AC input module)	QX11L (AC input module)
Number of input points		32 points	32 points
Insulation method		Photocoupler	Photocoupler
Rated input voltage, frequency		100 to 120VAC 50/60Hz	100 to 120VAC(+10/-15%) 50/60Hz(± 3Hz)
Input voltage distortion factor		Within 5%	Within 5%
Rated input current		10mA(100VAC,60Hz)	10mA(100VAC,60Hz)
Operating voltage range		85 to 132VAC (50/60Hz± 5%)	85 to 132VAC (50/60Hz± 5%)
Maximum number of simultaneous input points		60% (20 points) simultaneously ON	60% (20 points) simultaneously ON
Inrush current		Max.300mA Within 0.3ms (at 132VAC)	Max.300mA Within 0.3ms (at 132VAC)
ON voltage/ON current		80VAC or more/6mA or more	80VAC or more/6mA or more
OFF voltage/OFF current		40VAC or less/4mA or less	30VAC or less/2mA or less
Input impedance		Approx.10kΩ (60Hz), Approx.12kΩ (50Hz)	Approx.10kΩ (60Hz), Approx.12kΩ (50Hz)
Response time	OFF to ON	15ms or less	15ms or less
	ON to OFF	25ms or less	25ms or less
Dielectric withstand voltage		1500VAC for 1 minute	1780VAC rms/3 cycles (Altitude 2000m)
Common terminal arrangement		32 points/common (Common terminal: TB9, TB18, TB27, TB36)	32 points/common (Common terminal: TB9, TB18, TB27, TB36)
Operation indication		ON indication(LED)	ON indication(LED)
External connection method		38-point terminal block connector (M3 × 6 screws)	38-point terminal block connector (M3 × 6 screws)
Applicable wire size		0.75 to 2mm ² (Applicable tightening torque 0.68N·m)	0.75 to 2mm ² (Applicable tightening torque 0.68N·m)
Applicable solderless terminal		R1.25-3, R2-3, RAV1.25-3, RAV2-3	R1.25-3, R2-3, RAV1.25-3, RAV2-3
5VDC internal current consumption		110mA (TYP. all points ON)	75mA (TYP. all points ON)
External dimensions		250(H) × 37.5(W) × 131(D)mm	220(H) × 37.5(W) × 116.5(D)mm ^{*1}
Weight		0.49kg	0.33kg

*1 Indicates the depth dimension (D) when 38-point terminal block connector is not attached.

(2) QX21L type AC input module (specifications comparison with AX21)

Specifications		AX21 (AC input module)	QX21L (AC input module)
Number of input points		32 points	32 points
Insulation method		Photocoupler	Photocoupler
Rated input voltage, frequency		200 to 240VAC 50/60Hz	200 to 240VAC(+10/-15%) 50/60Hz(± 3Hz)
Input voltage distortion factor		Within 5%	Within 5%
Rated input current		10mA(220VAC,60Hz)	10mA(220VAC,60Hz)
Operating voltage range		170 to 264VAC (50/60Hz±5%)	170 to 264VAC (50/60Hz± 5%)
Maximum number of simultaneous input points		60% (20 points) simultaneously ON	60% (20 points) simultaneously ON (at 264VAC, 55°C) 100% (32 points) simultaneously ON (at 264VAC, 45°C)
Inrush current		Max.600mA Within 0.12ms (at 264VAC)	Max.600mA Within 0.12ms (at 264VAC)
ON voltage/ON current		160VAC or more/5.5mA or more	160VAC or more/5.5mA or more
OFF voltage/OFF current		70VAC or less/3.5mA or less	70VAC or less/3.5mA or less
Input impedance		Approx.22kΩ (60Hz), Approx.24kΩ (50Hz)	Approx.22kΩ (60Hz), Approx.27kΩ (50Hz)
Response time	OFF to ON	15ms or less	15ms or less
	ON to OFF	25ms or less	25ms or less
Dielectric withstand voltage		1500VAC for 1 minute	1500VAC for 1 minute
Common terminal arrangement		32 points/common (Common terminal: TB9, TB18, TB27, TB36)	32 points/common (Common terminal: TB9, TB18, TB27, TB36)
Operation indication		ON indication(LED)	ON indication(LED)
External connection method		38-point terminal block connector (M3 × 6 screws)	38-point terminal block connector (M3 × 6 screws)
Applicable wire size		0.75 to 2mm ² (Applicable tightening torque 0.68N•m)	0.75 to 2mm ² (Applicable tightening torque 0.68N•m)
Applicable solderless terminal		R1.25-3, R2-3, RAV1.25-3, RAV2-3	R1.25-3, R2-3, RAV1.25-3, RAV2-3
5VDC internal current consumption		110mA (TYP. all points ON)	75mA (TYP. all points ON)
External dimensions		250(H) × 37.5(W) × 131(D)mm	220(H) × 37.5(W) × 116.5(D)mm ^{*1}
Weight		0.50kg	0.33kg

*1 Indicates the depth dimension (D) when 38-point terminal block connector is not attached.

(3) QY11AL type contact output module (specifications comparison with AY10A)

Specifications		AY10A (contact output module)	QY11AL (contact output module)
Number of output points		16 points	16 points
Insulation method		Photocoupler	Photocoupler
Rated switching voltage/current		24VDC 2A (Resistance load)/point 240VAC 2A(COS ϕ =1)/point 16A/total	24VDC 2A (Resistance load)/point 240VAC 2A(COS ϕ =1)/point 16A/total
Minimum switching load		5VDC 1mA	5VDC 1mA
Maximum switching voltage		264VAC 125VDC	264VAC 125VDC
Leakage current at OFF		–	0.1mA (at 200VAC 60Hz)
Response time	OFF to ON	10ms or less	10ms or less
	ON to OFF	12ms or less	12ms or less
Life	Mechanical	20 million times or more	20 million times or more
	Electrical	Rated switching voltage/current load 200,000 times or more 200VAC 1.5A, 240VAC 1A (COS ϕ =0.7)200,000 times or more	Rated switching voltage/current load 200,000 times or more 200VAC 1.5A, 240VAC 1A (COS ϕ =0.7)200,000 times or more
		200VAC 0.75A, 240VAC 0.5A (COS ϕ =0.35)200,000 times or more	200VAC 0.75A, 240VAC 0.5A (COS ϕ =0.35)200,000 times or more
		24VDC 1A,100VDC 0.1A (L/R=7ms)200,000 times or more	24VDC 1A,100VDC 0.1A (L/R=7ms)200,000 times or more
Maximum switching frequency	3600 times/hr	3600 times/hr	
Surge suppressor		None	Varistor (387 to 473V)
Relay socket		None	None
Common terminal arrangement		Not provided (all points independent)	All points independent
Operation indication		ON indication(LED)	ON indication(LED)
External supply power	Voltage	24VDC \pm 10% Ripple voltage 4Vp-p or less	24VDC \pm 10% Ripple voltage 4Vp-p or less
	Current	150mA (TYP, 24VDC all points ON)	150mA (TYP, 24VDC all points ON)
External connection method		38-point terminal block connector (M3 \times 6 screws)	38-point terminal block connector (M3 \times 6 screws)
Applicable wire size		0.75 to 2mm ² (Applicable tightening torque 0.68N·m)	0.75 to 2mm ² (Applicable tightening torque 0.68N·m)
Applicable solderless terminal		R1.25-3, R2-3, RAV1.25-3, RAV2-3	R1.25-3, R2-3, RAV1.25-3, RAV2-3
5VDC internal current consumption		115mA (TYP.all points ON)	130mA (TYP, all points ON)
External dimensions		250(H) \times 37.5(W) \times 131(D)mm	220(H) \times 37.5(W) \times 116.5(D)mm ^{*1}
Weight		0.50kg	0.38kg

*1 Indicates the depth dimension (D) when 38-point terminal block connector is not attached.

(4) QY11AL type contact output module (specifications comparison with AY11A)

Specifications		AY11A (contact output module)	QY11AL (contact output module)
Number of output points		16 points	16 points
Insulation method		Photocoupler	Photocoupler
Rated switching voltage/current		24VDC 2A (Resistance load)/point 240VAC 2A(COS ϕ =1)/point 16A/total	24VDC 2A (Resistance load)/point 240VAC 2A(COS ϕ =1)/point 16A/total
Minimum switching load		5VDC 1mA	5VDC 1mA
Maximum switching voltage		264VAC 125VDC	264VAC 125VDC
Leakage current at OFF		0.1mA (at 200VAC 60Hz)	0.1mA (at 200VAC 60Hz)
Response time	OFF to ON	10ms or less	10ms or less
	ON to OFF	12ms or less	12ms or less
Life	Mechanical	20 million times or more	20 million times or more
	Electrical	Rated switching voltage/current load 200,000 times or more	Rated switching voltage/current load 200,000 times or more
		200VAC 1.5A, 240VAC 1A (COS ϕ =0.7)200,000 times or more	200VAC 1.5A, 240VAC 1A (COS ϕ =0.7)200,000 times or more
		200VAC 0.75A, 240VAC 0.5A (COS ϕ =0.35)200,000 times or more	200VAC 0.75A, 240VAC 0.5A (COS ϕ =0.35)200,000 times or more
		24VDC 1A,100VDC 0.1A (L/R=7ms)200,000 times or more	24VDC 1A,100VDC 0.1A (L/R=7ms)200,000 times or more
Maximum switching frequency		3600 times/hr	3600 times/hr
Surge suppressor		Varistor (387 to 473V)	Varistor (387 to 473V)
Relay socket		None	None
Common terminal arrangement		Not provided (all points independent)	All points independent
Operation indication		ON indication(LED)	ON indication(LED)
External supply power	Voltage	24VDC \pm 10% Ripple voltage 4Vp-p or less	24VDC \pm 10% Ripple voltage 4Vp-p or less
	Current	150mA (TYP, 24VDC all points ON)	150mA (TYP, 24VDC all points ON)
External connection method		38-point terminal block connector (M3 \times 6 screws)	38-point terminal block connector (M3 \times 6 screws)
Applicable wire size		0.75 to 2mm ² (Applicable tightening torque 0.68N \cdot m)	0.75 to 2mm ² (Applicable tightening torque 0.68N \cdot m)
Applicable solderless terminal		R1.25-3, R2-3, RAV1.25-3, RAV2-3	R1.25-3, R2-3, RAV1.25-3, RAV2-3
5VDC internal current consumption		115mA (TYP.all points ON)	130mA (TYP, all points ON)
External dimensions		250(H) \times 37.5(W) \times 131(D)mm	220(H) \times 37.5(W) \times 116.5(D)mm ^{*1}
Weight		0.47kg	0.38kg

*1 Indicates the depth dimension (D) when 38-point terminal block connector is not attached.

(5) QY11AL type contact output module (specifications comparison with AY11AEU)

Specifications		AY11AEU (contact output module)	QY11AL (contact output module)
Number of output points		16 points	16 points
Insulation method		Photocoupler	Photocoupler
Rated switching voltage/current		24VDC 2A (Resistance load)/point 24VAC 2A(COS ϕ =1)/point 16A/total	24VDC 2A (Resistance load)/point 240VAC 2A(COS ϕ =1)/point 16A/total
Minimum switching load		5VDC 1mA	5VDC 1mA
Maximum switching voltage		49.9VAC, 74.9VDC	264VAC, 125VDC
Leakage current at OFF		0.1mA (49.9VAC, 60Hz)	0.1mA (200VAC 60Hz)
Response time	OFF to ON	10ms or less	10ms or less
	ON to OFF	12ms or less	12ms or less
Life	Mechanical	20 million times or more	20 million times or more
	Electrical	Rated switching voltage/current load 200 thousand times or more	Rated switching voltage/current load 200 thousand times or more
		24VAC 1.5A (COS ϕ =0.7) 200 thousand times or more	200VAC 1.5A, 240VAC 1A (COS ϕ =0.7) 200 thousand times or more
		24VAC 0.75A (COS ϕ =0.35) 200 thousand times or more	200VAC 0.75A, 240VAC 0.5A (COS ϕ =0.35) 200 thousand times or more
		24VDC 1A, 48VDC 0.1A (L/R=7ms) 200 thousand times or more	24VDC 1A, 100VDC 0.1A (L/R=7ms) 200 thousand times or more
Maximum switching frequency		3600 times/hour	3600 times/hour
Surge suppressor		Varistor (387 to 473V)	Varistor (387 to 473V)
Dielectric withstand voltage (Across external circuit and internal circuit)		Between AC external terminals and ground, 1500VAC rms, 1 minute Between DC external terminals and ground, 500VAC rms, 1 minute	2830VAC rms/3cycles (Altitude 2,000m)
Insulation resistance		Between AC/DC external terminals and ground, 500VDC 10M Ω or more by insulation resistance tester	10M Ω or more by insulation resistance tester
Noise durability		By noise simulator of 1500Vp-p AC type noise voltage and 500Vp-p DC type noise voltage, 1 μ s noise width and 25 to 60Hz noise frequency	By noise simulator of 1500Vp-p noise voltage, 1 μ s noise width and 25 to 60Hz noise frequency First transient noise IEC61000-4-4: 1kV
Relay socket		None	None
Common terminal arrangement		Not provided (All points independent)	All points independent
Operation indication		ON indication (LED)	ON indication (LED)
External connection method	Voltage	24VDC \pm 10% Ripple voltage 4Vp-p or less	24VDC \pm 10% Ripple voltage 4Vp-p or less
	Current	150mA (24VDC TYP. all points ON)	150mA (24VDC TYP. all points ON)
External connection method		38-point terminal block connector (M3 \times 6 screws)	38-point terminal block connector (M3 \times 6 screws)
Applicable wire size		0.75 to 2mm ² (Applicable tightening torque 0.68N \cdot m)	0.75 to 2mm ² (Applicable tightening torque 0.68N \cdot m)
Applicable solderless terminal		R1.25-3, R2-3, RAV1.25-3, RAV2-3	R1.25-3, R2-3, RAV1.25-3, RAV2-3
5VDC internal current consumption		115mA (TYP. all points ON)	130mA (TYP. all points ON)
External dimensions		250 (H) \times 37.5 (W) \times 131 (D) mm	220 (H) \times 37.5 (W) \times 116.5 (D) mm ^{*1}
Weight		0.47kg	0.38kg

*1 Indicates the depth dimension (D) when 38-point terminal block connector is not attached.

(6) QY13L type contact output module (specifications comparison with AY13)

Specifications		AY13 (contact output module)	QY13L (contact output module)
Number of output points		32 points	32 points
Insulation method		Photocoupler	Photocoupler
Rated switching voltage/current		24VDC 2A (Resistance load)/point 240VAC 2A(COS ϕ =1)/point 5A/common	24VDC 2A (Resistance load)/point 240VAC 2A(COS ϕ =1)/point 5A/common
Minimum switching load		5VDC 1mA	5VDC 1mA
Maximum switching voltage		264VAC 125VDC	264VAC 125VDC
Response time	OFF to ON	10ms or less	10ms or less
	ON to OFF	12ms or less	12ms or less
Life	Mechanical	20 million times or more	20 million times or more
	Electrical	Rated switching voltage/current load 200,000 times or more	Rated switching voltage/current load 200,000 times or more
		200VAC 1.5A, 240VAC 1A (COS ϕ =0.7)200,000 times or more	200VAC 1.5A, 240VAC 1A (COS ϕ =0.7)200,000 times or more
		200VAC 0.75A, 240VAC 0.5A (COS ϕ =0.35)200,000 times or more	200VAC 0.75A, 240VAC 0.5A (COS ϕ =0.35)200,000 times or more
		24VDC 1A,100VDC 0.1A (L/R=7ms)200,000 times or more	24VDC 1A,100VDC 0.1A (L/R=7ms)200,000 times or more
Maximum switching frequency		3600 times/hr	3600 times/hr
Surge suppressor		None	None
Relay socket		None	None
Common terminal arrangement		8 points/common (Common terminal: TB9, TB18, TB27, TB36)	8 points/common (Common terminal: TB9, TB18, TB27, TB36)
Operation indication		ON indication(LED)	ON indication(LED)
External supply power	Voltage	24VDC \pm 10% Ripple voltage 4Vp-p or less	24VDC \pm 10% Ripple voltage 4Vp-p or less
	Current	290mA (TYP, 24VDC all points ON)	290mA (TYP, 24VDC all points ON)
External connection method		38-point terminal block connector (M3 \times 6 screws)	38-point terminal block connector (M3 \times 6 screws)
Applicable wire size		0.75 to 2mm ² (Applicable tightening torque 0.68N·m)	0.75 to 2mm ² (Applicable tightening torque 0.68N·m)
Applicable solderless terminal		R1.25-3, R2-3,RAV1.25-3, RAV2-3	R1.25-3, R2-3,RAV1.25-3, RAV2-3
5VDC internal current consumption		230mA (TYP.all points ON)	230mA (TYP, all points ON)
External dimensions		250(H) \times 37.5(W) \times 131(D)mm	220(H) \times 37.5(W) \times 116.5(D)mm ^{*1}
Weight		0.59kg	0.45kg

*1 Indicates the depth dimension (D) when 38-point terminal block connector is not attached.

(7) QY13L type contact output module (specifications comparison with AY13E)

Specifications		AY13E (contact output module)	QY13L (contact output module)
Number of output points		32 points	32 points
Insulation method		Photocoupler	Photocoupler
Rated switching voltage/current		24VDC 2A (Resistive load)/point 240VAC 2A (COS ϕ =1)/point 5A/common	24VDC 2A (Resistive load)/point 240VAC 2A (COS ϕ =1)/point 5A/common
Minimum switching load		5VDC 1mA	5VDC 1mA
Maximum switching voltage		250VAC 125VDC	264VAC 125VDC
Response time	OFF to ON	10ms or less	10ms or less
	ON to OFF	12ms or less	12ms or less
Life	Mechanical	20 million times or more	20 million times or more
	Electrical	Rated switching voltage/current load 200 thousand times or more	Rated switching voltage/current load 200 thousand times or more
		200VAC 1.5A, 240VAC 1A (COS ϕ =0.7) 200 thousand times or more	200VAC 1.5A, 240VAC 1A (COS ϕ =0.7) 200 thousand times or more
		200VAC 0.7A, 240VAC 0.5A (COS ϕ =0.35) 200 thousand times or more	200VAC 0.75A, 240VAC 0.5A (COS ϕ =0.35) 200 thousand times or more
	24VDC 1A, 100VDC 0.1A (L/R=7ms) 200 thousand times or more	24VDC 1A, 100VDC 0.1A (L/R=7ms) 200 thousand times or more	
Maximum switching frequency		3600 times/hour	3600 times/hour
Surge suppressor		None	None
Fuse		8A MF51NM8 or FGMA250V8A	None
Fuse blow indicator		None	—
Relay socket		None	None
Common terminal arrangement		8 points/common (Common terminal: TB9, TB18, TB27, TB36)	8 points/common (Common terminal: TB9, TB18, TB27, TB36)
Operation indication		ON indication (LED)	ON indication (LED)
External connection method	Voltage	24VDC \pm 10% Ripple voltage 4Vp-p or less	24VDC \pm 10% Ripple voltage 4Vp-p or less
	Current	290mA (24VDC TYP. all points ON)	290mA (24VDC TYP. all points ON)
External connection method		38-point terminal block connector (M3 \times 6 screws)	38-point terminal block connector (M3 \times 6 screws)
Applicable wire size		0.75 to 2mm ² (Applicable tightening torque 0.68N·m)	0.75 to 2mm ² (Applicable tightening torque 0.68N·m)
Applicable solderless terminal		R1.25-3, R2-3, RAV1.25-3, RAV2-3	R1.25-3, R2-3, RAV1.25-3, RAV2-3
5VDC internal current consumption		230mA (TYP. all points ON)	230mA (TYP. all points ON)
External dimensions		250 (H) \times 37.5 (W) \times 131 (D) mm	220 (H) \times 37.5 (W) \times 116.5(D)mm ^{*1}
Weight		0.60kg	0.45kg

*1 Indicates the depth dimension (D) when 38-point terminal block connector is not attached.

(8) QY13L type contact output module (specifications comparison with AY13EU)

Specifications		AY13EU (contact output module)	QY13L (contact output module)
Number of output points		32 points	32 points
Insulation method		Photocoupler	Photocoupler
Rated switching voltage/current		24VDC 2A (Resistive load)/point 24VAC 2A (COSφ=1)/point 5A/common	24VDC 2A (Resistive load)/point 240VAC 2A (COSφ=1)/point 5A/common
Minimum switching load		5VDC 1mA	5VDC 1mA
Maximum switching voltage		49.9VAC 74.9VDC	264VAC 125VDC
Response time	OFF to ON	10ms or less	10ms or less
	ON to OFF	12ms or less	12ms or less
Life	Mechanical	20 million times or more	20 million times or more
	Electrical	Rated switching voltage/current load 200 thousand times or more	Rated switching voltage/current load 200 thousand times or more
		24VAC 1.5A (COSφ=0.7) 200 thousand times or more	200VAC 1.5A, 240VAC 1A (COSφ=0.7) 200 thousand times or more
		24VAC 0.75A (COSφ=0.35) 200 thousand times or more	200VAC 0.75A, 240VAC 0.5A (COSφ=0.35) 200 thousand times or more
		24VDC 1A, 48VDC 0.1A (L/R=7ms) 200 thousand times or more	24VDC 1A, 100VDC 0.1A (L/R=7ms) 200 thousand times or more
Maximum switching frequency		3600 times/hour	3600 times/hour
Surge suppressor		None	None
Dielectric withstand voltage (Across external circuit and internal circuit)		Between AC external terminals and ground, 1500VAC rms, 1 minute Between DC external terminals and ground, 500VAC rms, 1 minute	2830VAC rms/3cycles (Altitude 2,000m)
Insulation resistance		Between AC/DC external terminals and ground, 500VDC 10MΩ or more by insulation resistance tester	10MΩ or more by insulation resistance tester
Noise durability		By noise simulator of 1500Vp-p AC type noise voltage and 500Vp-p DC type noise voltage, 1μs noise width and 25 to 60Hz noise frequency	By noise simulator of 1500Vp-p noise voltage, 1μs noise width and 25 to 60Hz noise frequency First transient noise IEC61000-4-4: 1kV
Relay socket		None	None
Common terminal arrangement		8 points/common (Common terminal: TB9, TB18, TB27, TB36)	8 points/common (Common terminal: TB9, TB18, TB27, TB36)
Operation indication		ON indication (LED)	ON indication (LED)
External power supply	Voltage	24VDC ±10% Ripple voltage 4Vp-p or less	24VDC ±10% Ripple voltage 4Vp-p or less
	Current	290mA (24VDC TYP. all points ON)	290mA (24VDC TYP. all points ON)
External connection method		38-point terminal block connector (M3 × 6 screws)	38-point terminal block connector (M3 × 6 screws)
Applicable wire size		0.75 to 2mm ² (Applicable tightening torque 0.68N•m)	0.75 to 2mm ² (Applicable tightening torque 0.68N•m)
Applicable solderless terminal		R1.25-3, R2-3, RAV1.25-3, RAV2-3	R1.25-3, R2-3, RAV1.25-3, RAV2-3
5VDC internal current consumption		230mA (TYP. all points ON)	230mA (TYP. all points ON)
External dimensions		250 (H) × 37.5 (W) × 131 (D) mm	220 (H) × 37.5 (W) × 116.5 (D) mm ^{*1}
Weight		0.59kg	0.45kg

*1 Indicates the depth dimension (D) when 38-point terminal block connector is not attached.

(9) QY23L type triac output module (specifications comparison with AY23)

Specifications		AY23 (triac output module)	QY23L (triac output module)
Number of output points		32 points	32 points
Insulation method		Photocoupler	Photocoupler
Rated load voltage		100 to 240VAC 40 to 70Hz	100 to 240VAC(+10/-15%)
maximum load voltage		264VAC	264VAC
Maximum load current		0.6A/point, 2.4A/common *1 (1.05A/common)	0.6A/point, 2.4A/common
Minimum load voltage/current*3		24VAC 100mA, 100VAC 10mA, 240VAC 10mA	24VAC 100mA, 100VAC 10mA, 240VAC 10mA
Maximum inrush current		20A 10ms or less, 8A 100ms or less	20A 10ms or less, 8A 100ms or less
Leakage current at OFF		1.5mA (120VAC 60Hz), 3mA (240VAC 60Hz)	1.5mA (120VAC 60Hz), 3mA (240VAC 60Hz)
Maximum voltage drop at ON		1.5VAC or less(100 to 600mA), 1.8VAC or less(50 to 100mA), 2VAC or less(10 to 50mA)	1.5VAC or less(100 to 600mA), 1.8VAC or less(50 to 100mA), 2VAC or less(10 to 50mA)
Response time	OFF to ON	1ms	1ms or less
	ON to OFF	1ms+0.5 cycle or less	1ms+0.5 cycle or less
Surge suppressor		CR absorber(0.022 μ F+47 Ω)	CR absorber(0.022 μ F+47 Ω)
Fuse rating		Fast blow fuse 3.2A (1 fuse/common) HP-32	Fast blow fuse 3.2A (1 fuse/common) HP-32
Fuse blown indication		Available (LED turns on by fuse blown, and a signal is output to the CPU module.)	Available (LED turns on by fuse blown, and a signal is output to the CPU module.)
Common terminal arrangement		8 points/common (Common terminal: TB9, TB18, TB27, TB36)	8 points/common (Common terminal: TB9, TB18, TB27, TB36)
Operation indication		ON indication(LED)	ON indication(LED)
External connection method		38-point terminal block connector (M3 \times 6 screws)	38-point terminal block connector (M3 \times 6 screws)
Applicable wire size		0.75 to 2mm ² (Applicable tightening torque 0.68N \cdot m)	0.75 to 2mm ² (Applicable tightening torque 0.68N \cdot m)
Applicable solderless terminal		R1.25-3, R2-3, RAV1.25-3, RAV2-3	R1.25-3, R2-3, RAV1.25-3, RAV2-3
5VDC internal current consumption		590mA (TYP, all points ON)	590mA (TYP, all points ON)
External dimensions		250(H) \times 37.5(W) \times 131(D)mm	220(H) \times 37.5(W) \times 116.5(D)mm*2
Weight		0.55kg	0.45kg

*1 When used at next to the power supply module, the maximum load current becomes the value in ().

*2 Indicates the depth dimension (D) when 38-point terminal block connector is not attached.

*3 When the inductive load such as the solenoid valve is used, the current consumption is equal to or less than minimum load current, and the margin is not enough, take measures such as using the bleeder resistance because the load may not turned on/off.

(10)QY51PL type transistor output module (specifications comparison with AY51)

Specifications		AY51 (transistor output module)	QY51PL (transistor output module)
Number of output points		32 points	32 points
Insulation method		Photocoupler	Photocoupler
Rated load voltage		12/24VDC	12/24VDC
Operating load voltage range		10.2 to 30VDC	10.2 to 28.8VDC
Maximum load current		0.5A/point, 4A/common (When placing next to the power supply module: 3.3A/common)	0.5A/point, 4A/common
Maximum inrush current		4A 10ms or less	No limit (overload protection function)
Leakage current (OFF)		0.1mA or less	0.1mA or less
Maximum voltage drop at ON		0.9VDC (TYP.) 0.5A 1.5VDC (Max.) 0.5A	0.2VDC (TYP.) 0.5A 0.3VDC (Max.) 0.5A
Response time	OFF to ON	2ms or less	0.5ms or less
	ON to OFF	2ms or less (Resistance load)	1ms or less (Resistive load)
Surge suppressor		Varistor (52 to 62V)	Zener diode
Common terminal arrangement		16 points/common (Common terminal: TB18, TB36)	16 points/common (Common terminal: TB18, TB36)
Protection function		None	Yes (overheat protection function, overload protection function) • Overheat protection function is activated in increments of 1 point. • Overload protection function is activated in increments of 1 point.
Operation indication		ON indication (LED)	ON indication (LED)
External connection method		38-point terminal block connector (M3 × 6 screws)	38-point terminal block connector (M3 × 6 screws)
Applicable wire size		0.75 to 2mm ² (Applicable tightening torque 0.68N•m)	0.75 to 2mm ² (Applicable tightening torque 0.68N•m)
Applicable solderless terminal		R1.25-3, R2-3, RAV1.25-3, RAV2-3	R1.25-3, R2-3, RAV1.25-3, RAV2-3
External power supply	Voltage	12/24VDC (10.2 to 30VDC)	12/24VDC (10.2 to 28.8VDC)
	Current	50mA (24VDC TYP. /common)	8mA (24VDC TYP. /common)
5VDC internal current consumption		230mA (TYP. all points ON)	100mA (TYP. all points ON)
External dimensions		250 (H) × 37.5 (W) × 131 (D) mm	220 (H) × 37.5 (W) × 116.5 (D) mm ^{*1}
Weight		0.53kg	0.28kg

*1 Indicates the depth dimension (D) when 38-point terminal block connector is not attached.

(11) QY51PL type transistor output module (specifications comparison with AY51-S1)

Specifications		AY51-S1 (transistor output module)	QY51PL (transistor output module)
Number of output points		32 points	32 points
Insulation method		Photocoupler	Photocoupler
Rated load voltage		12/24VDC	12/24VDC
Operating load voltage range		10.2 to 30VDC	10.2 to 28.8VDC
Maximum load current		0.3A/point, 2A/common (1A fuse common)	0.5A/point, 4A/common
Maximum inrush current		3A 10ms or less	No limit (overload protection function)
Leakage current (OFF)		0.1mA or less	0.1mA or less
Maximum voltage drop at ON		1VDC (TYP.) 0.3A 1.5VDC (Max.) 0.3A	0.2VDC (TYP.) 0.5A 0.3VDC (Max.) 0.5A
Response time	OFF to ON	2ms or less	0.5ms or less
	ON to OFF	2ms or less (Resistance load)	1ms or less (Resistance load)
Surge suppressor		Transistor built-in zener diode	Zener diode
Common terminal arrangement		16 points/common (Common terminal: TB18, TB36) 8 points/fuse common	16 points/common (Common terminal: TB18, TB36)
Protection function		None	Yes (overheat protection function, overload protection function) • Overheat protection function is activated in increments of 1 point. • Overload protection function is activated in increments of 1 point.
Fuse		1A fast blow fuse (2 fuses per common in units of 8 points) MP-10	None
Fuse blow indicator		Yes (LED is turned ON when fuse is blown. Signal is output to a programmable controller CPU.)	—
Operation indication		ON indication (LED)	ON indication (LED)
External connection method		38-point terminal block connector (M3 × 6 screws)	38-point terminal block connector (M3 × 6 screws)
Applicable wire size		0.75 to 2mm ² (Applicable tightening torque 0.68N·m)	0.75 to 2mm ² (Applicable tightening torque 0.68N·m)
Applicable solderless terminal		R1.25-3, R2-3, RAV1.25-3, RAV2-3	R1.25-3, R2-3, RAV1.25-3, RAV2-3
External power supply	Voltage	12/24VDC (10.2 to 30VDC)	12/24VDC (10.2 to 28.8VDC)
	Current	100mA (24VDC TYP. /common)	8mA (24VDC TYP. /common)
5VDC internal current consumption		310mA (TYP. all points ON)	100mA (TYP. all points ON)
External dimensions		250 (H) × 37.5 (W) × 131 (D) mm	220 (H) × 37.5 (W) × 116.5 (D) mm ^{*1}
Weight		0.55kg	0.28kg

*1 Indicates the depth dimension (D) when 38-point terminal block connector is not attached.

(12)QY51PL type transistor output module (specifications comparison with AY41)

Specifications		AY41 (transistor output module)	QY51PL (transistor output module)
Number of output points		32 points	32 points
Insulation method		Photocoupler	Photocoupler
Rated load voltage		12/24VDC	12/24VDC
Operating voltage range		10.2 to 40VDC	10.2 to 28.8VDC
Maximum load current		0.1A/point, 1.6A/common	0.5A/point, 4A/common
Maximum inrush current		0.4A	No limit (overload protection function)
Leakage current (OFF)		0.1mA or less	0.1mA or less
Maximum voltage drop at ON		2.5VDC (0.1A)	0.2VDC (TYP.) 0.5A
		1.75VDC (5mA)	0.3VDC (Max.) 0.5A
		1.7VDC (1mA)	
Response time	OFF to ON	2ms or less	0.5ms or less
	ON to OFF	2ms or less (Resistive load)	1ms or less (Resistive load)
Surge suppressor		Clamp diode	Zener diode
Common terminal arrangement		16 points/common (Common terminal: TB18, TB36)	16 points/common (Common terminal: TB18, TB36)
Protection function		No	Yes (overheat protection function, overload protection function) • Overheat protection function is activated in increments of 1 point. • Overload protection function is activated in increments of 1 point.
Operation indication		ON indication(LED)	ON indication(LED)
External connection method		38-point terminal block connector (M3 × 6 screws)	38-point terminal block connector (M3 × 6 screws)
Applicable wire size		0.75 to 2mm ² (Applicable tightening torque 0.68N•m)	0.75 to 2mm ² (Applicable tightening torque 0.68N•m)
Applicable solderless terminal		R1.25-3, R2-3, RAV1.25-3, RAV2-3	R1.25-3, R2-3, RAV1.25-3, RAV2-3
External power supply	Voltage	12/24VDC (10.2 to 40VDC)	12/24VDC (10.2 to 28.8VDC)
	Current	20mA (24VDC TYP. /common)	8mA (24VDC TYP. /common)
5VDC internal current consumption		230mA (TYP. all points ON)	100mA (TYP. all points ON)
External dimensions		250(H) × 37.5(W) × 131(D)mm	220(H) × 37.5(W) × 116.5(D)mm ^{*1}
Weight		0.44kg	0.28kg

*1 Indicates the depth dimension (D) when 38-point terminal block connector is not attached.

(13) QY51PL type transistor output module (specifications comparison with AY41P)

Specifications		AY41P (transistor output module)	QY51PL (transistor output module)
Number of output points		32 points	32 points
Insulation method		Photocoupler	Photocoupler
Rated load voltage		12/24VDC	12/24VDC
Operating voltage range		10.2 to 26.4VDC	10.2 to 28.8VDC
Maximum load current		0.1A/point, 1.0A/common	0.5A/point, 4A/common
Maximum inrush current		0.38A 5ms or less	No limit (overload protection function)
Leakage current (OFF)		0.1mA or less	0.1mA or less
Maximum voltage drop at ON		2.5VDC (0.1A)	0.2VDC (TYP.) 0.5A 0.3VDC (Max.) 0.5A
		1.75VDC (5mA)	
		1.7VDC (1mA)	
Response time	OFF to ON	2ms or less	0.5ms or less
	ON to OFF	2ms or less (Resistive load)	1ms or less (Resistive load)
Surge suppressor		Clamp diode	Zener diode
Common terminal arrangement		16 points/common (Common terminal: TB18, TB36)	16 points/common (Common terminal: TB18, TB36)
Protection function		Yes (overheat protection function, short-circuit protection function)	Yes (overheat protection function, overload protection function) • Overheat protection function is activated in increments of 1 point. • Overload protection function is activated in increments of 1 point.
Operation indication		ON indication(LED)	ON indication(LED)
External connection method		38-point terminal block connector (M3 × 6 screws)	38-point terminal block connector (M3 × 6 screws)
Applicable wire size		0.75 to 2mm ² (Applicable tightening torque 0.68N·m)	0.75 to 2mm ² (Applicable tightening torque 0.68N·m)
Applicable solderless terminal		R1.25-3, R2-3, RAV1.25-3, RAV2-3	R1.25-3, R2-3, RAV1.25-3, RAV2-3
External power supply	Voltage	12/24VDC (10.8 to 26.4VDC)	12/24VDC (10.2 to 28.8VDC)
	Current	30mA (24VDC TYP. /common)	8mA (24VDC TYP. /common)
5VDC internal current consumption		230mA (TYP. all points ON)	100mA (TYP. all points ON)
External dimensions		250(H) × 37.5(W) × 131(D)mm	220(H) × 37.5(W) × 116.5(D)mm ^{*1}
Weight		0.44kg	0.28kg

*1 Indicates the depth dimension (D) when 38-point terminal block connector is not attached.

(14) Q series large type blank cover

The cover is for filling a gap between the large type base unit and existing Q series module.

Item	Model
	QG69L
External dimensions	108(H) × 37.5(W) × 54(D)mm
Weight	0.03kg

3.4.2 Precautions for using the Q series large type I/O module

(1) 32-point terminal block for I/O module

The Q series large type I/O module does not include 32-point terminal block.
 To use the Q series large type I/O module in a new system, purchase the following MELSEC-A series 32-point terminal block separately.

Product	Model	Manufacturer	Contact
MELSEC-A series 32-point terminal block	K14K 08H 075 000 03	Mitsubishi Electric System & Service Co., Ltd.	Section 1.2.2

(2) Mounting dimensions of the Q series large type I/O module

The Q series large type I/O module is larger than A series 32-point I/O module in depth by 14mm.
 Before replacing the A/QnA series, check if there is enough space for depth.

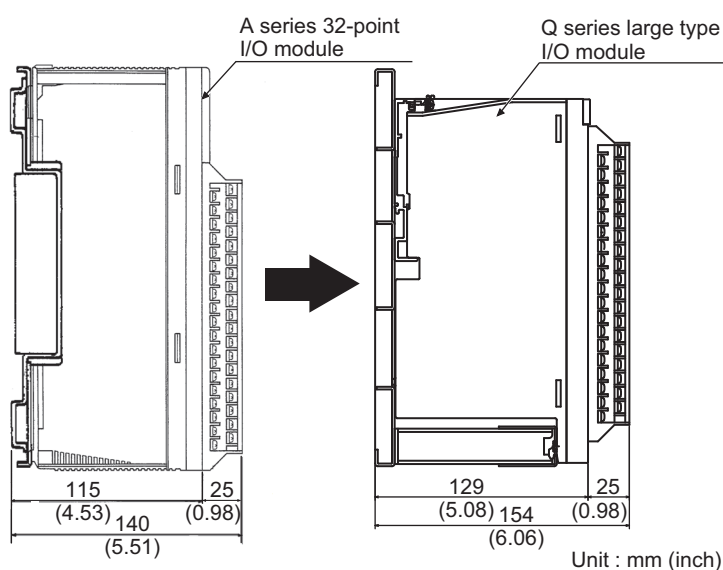

4 POWER SUPPLY MODULE REPLACEMENTS

4.1 List of Alternative Models for Power Supply Module

A/QnA series models to be discontinued		Q series alternative models	
Product name	Model	Model	Remarks (restrictions)
Power supply module	A61P	Q61P*1	1) Change in external wiring: Required
	A61PN		2) Change in the number of slots : Not required
	A61P-UL		3) Change in specifications: Current capacity is reduced.
	A61PEU	Q61P	1) Change in external wiring: Required 2) Change in the number of slots : Not required 3) Change in specifications: Current capacity is reduced.
	A62PEU	Q62P	1) Change in external wiring: Required 2) Change in the number of slots : Not required 3) Change in specifications: Current capacity is reduced.
	A62P	Q62P	1) Change in external wiring: Required 2) Change in the number of slots : Not required 3) Change in specifications: Current capacity is reduced.
	A63P	Q63P	1) Change in external wiring: Required 2) Change in the number of slots : Not required 3) Change in specifications: Current capacity is reduced.
	A65P	Q62P	1) Change in external wiring: Required 2) Change in the number of slots : Not required 3) Change in specifications: 24VDC current capacity is reduced.
	A66P*3	None	The Q series do not come in a power supply module capable of 24VDC output. Prepare 24VDC power supply externally.
	A67P	None	The Q series do not come in a 100VDC power supply module. Change to 24VDC externally and consider the replacement with the Q63P (24VDC).
	A68P*3	None*2	General-purpose switching power supply (For ± 15 VDC)
	A1NCPU (power supply part)	Q62P	1) Change in external wiring: Required 2) Change in the number of slots : Not required (changed from the integrated structure of CPU module and power supply part to a design for separate selection) 3) Change in specifications: Current capacity is reduced.

- *1 It is also possible to replace this model with the power supply module Q61SP. However, check for the details since the specification differs.
(Example) Q61SP: rated output current (5VDC 2A), mountable only to the main base unit (Q3□SB)
If there is a shortage in capacity of 5VDC after the module configuration, select the Q64PN (Capacity of 5VDC: 8.5A).
- *2 A power supply of each Q series module that requires power feeding to external is "24VDC".
A "15VDC" power supply for Q series module is not required.
- *3 Mount this module on the slot for mounting an I/O module.
When a power supply module is prepared externally, the slot is left to be empty and thus requires the blank cover (QG60) to be attached.

☒ Point

When replacing the A/QnA series with power supply module of the A61PN by the Q series, replacing the A61PN by the Q61P is recommended.

(For specifications comparisons between the A61PN and Q61P, refer to Section 4.2 (2).)

The A61PN can be used as a spare part for the A/QnA series or as a power supply module for the QA6□B extension base unit.

4.2 Power Supply Module Specifications Comparisons

(1) Specifications comparison between A61P(-UL) and Q61P

○: Compatible, △: Partial change required, ×: Incompatible

Specification	A61P(-UL)	Q61P	Compat- ibility	Precautions for replacement
Input power supply	100-120VAC+10%-15% (85 to 132VAC)	100-240VAC+10%-15% (85 to 264VAC)	○	The Q61P is wide range type applicable to 100 to 240VAC.
	200-240VAC+10%-15% (170 to 264VAC)			
Input frequency	50/60Hz ± 5%	50/60Hz ± 5%	○	
Input voltage distortion	5% or less	5% or less	○	
Max. input apparent power	160VA	130VA	○	
Inrush current	20A within 8ms	20A within 8ms	○	
Rated output current	5VDC	8A	△	Check the current consumption of entire system.
	24VDC	–	–	
Overcurrent protection	5VDC	8.8A or more	○	
	24VDC	–	–	
Overvoltage protection	5VDC	5.5 to 6.5V	○	
	24VDC	–	–	
Efficiency	65% or more	70% or more	○	
Dielectric withstand voltage	Across external AC terminal batch and ground: 1500VAC for 1 minute Across external DC terminal batch and ground: 500VAC for 1 minute	Across inputs/LG and outputs/FG 2830VAC rms/3 cycles (2000 m)	○	
Noise durability	Noise voltage 1500Vp-p	<ul style="list-style-type: none"> • By noise simulator of 1500Vp-p noise voltage, 1μs noise width and 25 to 60Hz noise frequency • Noise voltage IEC61000-4-4, 2kV 	○	
Insulation resistance	Across external AC terminal batch and ground 5MΩ or more by 500VDC insulation resistance tester.	<ul style="list-style-type: none"> • Between all inputs-LG and all outputs-FG • Between all inputs and LG • Between all outputs and FG 10MΩ or more by 500VDC insulation resistance tester	○	
Power indicator	Power LED display	LED indication (5VDC output: ON)	○	
Terminal screw size	M4 × 0.7 × 6	M3.5 screws	×	Wiring change is required.
Applicable wire size	0.75 to 2mm ²	0.75 to 2mm ²	○	
Applicable solderless terminal	R1.25-4, R2-4 RAV1.25-4, RAV2-4	RAV1.25-3.5, RAV2-3.5	×	Wiring change is required.
Applicable tightening torque	78 to 118N·cm	66 to 89N·cm	×	Tighten within the applicable tightening torque.
External dimensions	250(H) × 55(W) × 121(D) mm	98(H) × 55.2(W) × 90(D) mm	△	
Weight (kg)	0.98	0.40	△	
Allowable momentary power failure period	within 20ms	within 20ms	○	
Accessory	Spare fuse: 1 Short chip for applied voltage select terminal: 1	None	×	Fuses are not included in accessories since they are not replaceable, nor are short chip since it is unnecessary to switch operating voltage.

(2) Specifications comparison between A61PN and Q61P

○: Compatible, △: Partial change required, ×: Incompatible

Specification	A61PN	Q61P	Compatibility	Precautions for replacement	
Input power supply	100-120VAC+10%-15% (85 to 132VAC)	100-240VAC+10%-15% (85 to 264VAC)	○	The Q61P is wide range type applicable to 100 to 240VAC.	
	200-240VAC+10%-15% (170 to 264VAC)				
Input frequency	50/60Hz ± 5%	50/60Hz ± 5%	○		
Input voltage distortion	5% or less	5% or less	○		
Max. input apparent power	160VA	130VA	○		
Inrush current	20A within 8ms	20A within 8ms	○		
Rated output current	5VDC	8A	6A	△	Check the current consumption of entire system.
	24VDC	—	—	—	
Overcurrent protection	5VDC	8.8A or more	6.6A or more	○	
	24VDC	—	—	—	
Overvoltage protection	5VDC	5.5 to 6.5V	5.5 to 6.5V	○	
	24VDC	—	—	—	
Efficiency	65% or more	70% or more	○		
Dielectric withstand voltage	Across external AC terminal batch and ground: 1500VAC for 1 minute Across external DC terminal batch and ground: 500VAC for 1 minute	Across inputs/LG and outputs/FG 2830VAC rms/3 cycles (2000 m)	○		
Noise durability	Noise voltage 1500Vp-p	<ul style="list-style-type: none"> By noise simulator of 1500Vp-p noise voltage, 1μs noise width and 25 to 60Hz noise frequency Noise voltage IEC61000-4-4, 2kV 	○		
Insulation resistance	Across external AC terminal batch and ground 5MΩ or more by insulation resistance tester.	<ul style="list-style-type: none"> Between all inputs-LG and all outputs-FG Between all inputs and LG Between all outputs and FG 10MΩ or more by 500VDC insulation resistance tester	○		
Power indicator	Power LED display	LED indication (5VDC output: ON)	○		
Terminal screw size	M4 × 0.7 × 6	M3.5 screws	×	Wiring change is required.	
Applicable wire size	0.75 to 2mm ²	0.75 to 2mm ²	○		
Applicable solderless terminal	R1.25-4, R2-4 RAV1.25-4, RAV2-4	RAV1.25-3.5, RAV2-3.5	×	Wiring change is required.	
Applicable tightening torque	78 to 118N·cm	66 to 89N·cm	×	Tighten within the applicable tightening torque.	
External dimensions	250(H) × 55(W) × 121(D) mm	98(H) × 55.2(W) × 90(D) mm	△		
Weight (kg)	0.75	0.40	△		
Allowable momentary power failure period	within 20ms	within 20ms	○		
Accessory	Spare fuse: 1 Short chip for applied voltage select terminal: 1	None	×	Fuses are not included in accessories since they are not replaceable, nor are short chip since it is unnecessary to switch operating voltage.	

(3) Specifications comparison between A61PEU and Q61P

○: Compatible, △: Partial change required, ×: Incompatible

Specification	A61PEU	Q61P	Compat- ibility	Precautions for replacement
Input power supply	100-120VAC+10%-15% (85 to 132VAC)	100-240VAC+10%-15% (85 to 264VAC)	○	The Q61P is wide range type applicable to 100 to 240VAC.
	200-240VAC+10%-15% (170 to 264VAC)			
Input frequency	50/60Hz ± 5%	50/60Hz ± 5%	○	
Input voltage distortion	5% or less	5% or less	○	
Max. input apparent power	130VA	130VA	○	
Inrush current	20A within 8ms	20A within 8ms	○	
Rated output current	5VDC	8A	△	Check the current consumption of entire system.
	24VDC	—	—	
Overcurrent protection	5VDC	8.8A or more	○	
	24VDC	—	—	
Overvoltage protection	5VDC	5.5 to 6.5V	○	
	24VDC	—	—	
Efficiency	65% or more	70% or more	○	
Dielectric withstand voltage	Between primary side and FG 2830VAC rms/3 cycles (2000 m)	Across inputs/LG and outputs/FG 2830VAC rms/3 cycles (2000 m)	○	
Noise durability	By noise simulator of noise voltage of IEC801-4, 2KV, 1500Vp-p, noise width of 1μs, and noise frequency of 25 to 60Hz	• By noise simulator of 1500Vp-p noise voltage, 1μs noise width and 25 to 60Hz noise frequency • Noise voltage IEC61000-4-4, 2kV	○	
Insulation resistance	Between all inputs and all outputs (LG and FG separated), between all inputs and LG/FG, between all outputs and FG/LG 10MΩ or more by 500VDC insulation resistance tester	• Between all inputs-LG and all outputs-FG • Between all inputs and LG • Between all outputs and FG 10MΩ or more by 500VDC insulation resistance tester	○	
Power indicator	Power LED display	LED indication (5VDC output: ON)	○	
Terminal screw size	M4 × 0.7 × 6	M3.5 screws	×	Wiring change is required.
Applicable wire size	0.75 to 2mm ²	0.75 to 2mm ²	○	
Applicable solderless terminal	RAV1.25-4, RAV2-4	RAV1.25-3.5, RAV2-3.5	×	Wiring change is required.
Applicable tightening torque	98 to 137N·cm	66 to 89N·cm	×	Tighten within the applicable tightening torque.
External dimensions	250(H) × 55(W) × 121(D) mm	98(H) × 55.2(W) × 90(D) mm	△	
Weight (kg)	0.80	0.40	△	
Allowable momentary power failure period	Within 20ms	Within 20ms	○	
Accessory	Spare fuse: 1 Short chip for applied voltage select terminal: 1	None	×	Fuses are not included in accessories since they are not replaceable, nor are short chip since it is unnecessary to switch operating voltage.

(4) Specifications comparison between A62PEU and Q62P

○: Compatible, △: Partial change required, ×: Incompatible

Specification	A62PEU	Q62P	Compatibility	Precautions for replacement
Input power supply	100-120VAC+10%-15% (85 to 132VAC)	100-240VAC+10%-15% (85 to 264VAC)	○	The Q62P is wide range type applicable to 100 to 240VAC.
	200-240VAC+10%-15% (170 to 264VAC)			
Input frequency	50/60Hz ± 5%	50/60Hz ± 5%	○	
Input voltage distortion	5% or less	5% or less	○	
Max. input apparent power	155VA	105VA	○	
Inrush current	20A within 8ms	20A within 8ms	○	
Rated output current	5VDC	3A	△	Check the current consumption of entire system.
	24VDC	0.6A	△	
Overcurrent protection	5VDC	3.3A or more	○	
	24VDC	0.66A or more	○	
Overvoltage protection	5VDC	5.5 to 6.5V	○	
	24VDC	-	-	
Efficiency	65% or more	65% or more	○	
Dielectric withstand voltage	Between primary side and FG 2830VAC rms/3 cycles (2000 m)	Across inputs/LG and outputs/FG 2830VAC rms/3 cycles (2000 m)	○	
Noise durability	By noise simulator of noise voltage of IEC801-4, 2KV, 1500Vp-p, noise width of 1μs, and noise frequency of 25 to 60Hz	<ul style="list-style-type: none"> • By noise simulator of 1500Vp-p noise voltage, 1μs noise width and 25 to 60Hz noise frequency • Noise voltage IEC61000-4-4, 2kV 	○	
Insulation resistance	Between all inputs and all outputs (LG and FG separated), between all inputs and LG/FG, between all outputs and FG/LG 10MΩ or more by 500VDC insulation resistance tester	<ul style="list-style-type: none"> • Between all inputs-LG and all outputs-FG • Between all inputs and LG • Between all outputs and FG 10MΩ or more by 500VDC insulation resistance tester	○	
Power indicator	Power LED display	LED indication (5VDC output: ON)	○	
Terminal screw size	M4 × 0.7 × 6	M3.5 screws	×	Wiring change is required.
Applicable wire size	0.75 to 2mm ²	0.75 to 2mm ²	○	
Applicable solderless terminal	RAV1.25-4, RAV2-4	RAV1.25-3.5, RAV2-3.5	×	Wiring change is required.
Applicable tightening torque	98 to 137N·cm	66 to 89N·cm	×	Tighten within the applicable tightening torque.
External dimensions	250(H) × 55(W) × 121(D) mm	98(H) × 55.2(W) × 90(D) mm	-	
Weight (kg)	0.9	0.39	△	
Allowable momentary power failure period	Within 20ms	Within 20ms	○	
Accessory	Spare fuse: 1 Short chip for applied voltage select terminal: 1	None	×	Fuses are not included in accessories since they are not replaceable, nor are short chip since it is unnecessary to switch operating voltage.

(5) Specifications comparison between A62P and Q62P

○: Compatible, △: Partial change required, ×: Incompatible

Specification	A62P	Q62P	Compat- ibility	Precautions for replacement
Input power supply	100-120VAC+10%-15% (85 to 132VAC)	100-240VAC+10%-15% (85 to 264VAC)	○	The Q62P is wide range type applicable to 100 to 240VAC.
	200-240VAC+10%-15% (170 to 264VAC)			
Input frequency	50/60Hz ± 5%	50/60Hz ± 5%	○	
Input voltage distortion	5% or less	5% or less	○	
Max. input apparent power	155VA	105VA	○	
Inrush current	20A within 8ms	20A within 8ms	○	
Rated output current	5VDC	3A	△	Check the current consumption of entire system.
	24VDC	0.6A	△	
Overcurrent protection	5VDC	3.3A or more	○	
	24VDC	1.2A or more	○	
Overvoltage protection	5VDC	5.5 to 6.5V	○	
	24VDC	-	-	
Efficiency	65% or more	65% or more	○	
Dielectric withstand voltage	Across external AC terminal batch and ground: 1500VAC for 1 minute Across external DC terminal batch and ground: 500VAC for 1 minute	Across inputs/LG and outputs/FG 2830VAC rms/3 cycles (2000 m)	○	
Noise durability	Noise voltage: 1500Vp-p	<ul style="list-style-type: none"> • By noise simulator of 1500Vp-p noise voltage, 1μs noise width and 25 to 60Hz noise frequency • Noise voltage IEC61000-4-4, 2kV 	○	
Insulation resistance	Across external AC terminal batch and ground 5MΩ or more by 500VDC insulation resistance tester.	<ul style="list-style-type: none"> • Between all inputs-LG and all outputs-FG • Between all inputs and LG • Between all outputs and FG 10MΩ or more by 500VDC insulation resistance tester 	○	
Power indicator	Power LED display	LED indication (5VDC output: ON)	○	
Terminal screw size	M4 × 0.7 × 6	M3.5 screws	×	Wiring change is required.
Applicable wire size	0.75 to 2mm ²	0.75 to 2mm ²	○	
Applicable solderless terminal	R1.25-4, R2-4 RAV1.25-4, RAV2-4	RAV1.25-3.5, RAV2-3.5	×	Wiring change is required.
Applicable tightening torque	78 to 118N·cm	66 to 89N·cm	×	Tighten within the applicable tightening torque.
External dimensions	250(H) × 55(W) × 121(D)mm	98(H) × 55.2(W) × 90(D)mm	△	
Weight (kg)	0.94	0.39	△	
Allowable momentary power failure period	Within 20ms	Within 20ms	○	
Accessory	Spare fuse: 1 Short chip for applied voltage select terminal: 1	None	×	Fuses are not included in accessories since they are not replaceable, nor are short chip since it is unnecessary to switch operating voltage.

(6) Specifications comparison between A63P and Q63P

○: Compatible, △: Partial change required, ×: Incompatible

Specification		A63P	Q63P	Compat- ibility	Precautions for replacement
Input power supply		24VDC+30%-35% (15.6 to 31.2VDC)	24VDC+30%-35% (15.6 to 31.2VDC)	○	
Input frequency		—	—	—	
Input voltage distortion		—	—	—	
Max. input apparent power		65W	45W	○	
Inrush current		100A within 1ms	100A within 1ms with 24VDC input	○	
Rated output current	5VDC	8A	6A	△	Check the current consumption of entire system.
	24VDC	—	—	—	
Overcurrent protection	5VDC	8.5A or more	6.6A or more	○	
	24VDC	—	—	—	
Overvoltage protection	5VDC	5.5 to 6.5V	5.5 to 6.5V	○	
	24VDC	—	—	—	
Efficiency		65% or more	70% or more	○	
Dielectric withstand voltage		Across external DC terminal batch and ground: 500VAC for 1 minute	Between all inputs-LG and all outputs-FG: 500VAC for 1 minute	○	
Noise durability		Noise voltage: 1500Vp-p	• By noise simulator of 500Vp-p noise voltage, 1μs noise width and 25 to 60Hz noise frequency	○	
Insulation resistance		Across external DC terminals batch and ground 5MΩ or more by insulation resistance tester.	• Between all inputs-LG and all outputs-FG • Between all inputs and LG • Between all outputs and FG 10MΩ or more by 500VDC insulation resistance tester	○	
Power indicator		Power LED display	LED indication (5VDC output: ON)	○	
Terminal screw size		M4 × 0.7 × 6	M3.5 screws	×	Wiring change is required.
Applicable wire size		0.75 to 2mm ²	0.75 to 2mm ²	○	
Applicable solderless terminal		R1.25-4, R2-4 RAV1.25-4, RAV2-4	RAV1.25-3.5, RAV2-3.5	×	Wiring change is required.
Applicable tightening torque		78 to 118N·cm	66 to 89N·cm	×	Tighten within the applicable tightening torque.
External dimensions		250(H) × 55(W) × 121(D)mm	98(H) × 55.2(W) × 90(D)mm	△	
Weight (kg)		0.8	0.33	△	
Allowable momentary power failure period		Within 1ms	Within 10ms with 24VDC input	○	
Accessory		Spare fuse: 1	None	×	Fuses are not included in accessories since they are not replaceable.

(7) Specifications comparison between A65P and Q62P

○: Compatible, △: Partial change required, ×: Incompatible

Specification	A65P	Q62P	Compatibility	Precautions for replacement
Input power supply	100-120VAC+10%-15% (85 to 132VAC)	100-240VAC+10%-15% (85 to 264VAC)	○	The Q62P is wide range type applicable to 100 to 240VAC.
	200-240VAC+10%-15% (170 to 264VAC)			
Input frequency	50/60Hz ± 5%	50/60Hz ± 5%	○	
Input voltage distortion	5% or less	5% or less	○	
Max. input apparent power	110VA	105VA	○	
Inrush current	20A within 8ms	20A within 8ms	○	
Rated output current	5VDC	2A	△	Check the current consumption of entire system because of the less capacity of 24V.
	24VDC	1.5A	△	
Overcurrent protection	5VDC	2.2A or more	○	
	24VDC	2.3A or more	○	
Overvoltage protection	5VDC	5.5 to 6.5V	○	
	24VDC	-	-	
Efficiency	65% or more	65% or more	○	
Dielectric withstand voltage	Across external AC terminal batch and ground: 1500VAC for 1 minute Across external DC terminal batch and ground: 500VAC for 1 minute	Across inputs/LG and outputs/FG 2830VAC rms/3 cycles (2000 m)	○	
Noise durability	Noise voltage: 1500Vp-p	<ul style="list-style-type: none"> • By noise simulator of 1500Vp-p noise voltage, 1μs noise width and 25 to 60Hz noise frequency • Noise voltage IEC61000-4-4, 2kV 	○	
Insulation resistance	Across external AC terminal batch and ground 5MΩ or more by 500VDC insulation resistance tester.	<ul style="list-style-type: none"> • Between all inputs-LG and all outputs-FG • Between all inputs and LG • Between all outputs and FG 10MΩ or more by 500VDC insulation resistance tester	○	
Power indicator	Power LED display	LED indication (5VDC output: ON)	○	
Terminal screw size	M4 × 0.7 × 6	M3.5 screws	×	Wiring change is required.
Applicable wire size	0.75 to 2mm ²	0.75 to 2mm ²	○	
Applicable solderless terminal	R1.25-4, R2-4 RAV1.25-4, RAV2-4	RAV1.25-3.5, RAV2-3.5	×	Wiring change is required.
Applicable tightening torque	78 to 118N·cm	66 to 89N·cm	×	Tighten within the applicable tightening torque.
External dimensions	250(H) × 55(W) × 121(D)mm	98(H) × 55.2(W) × 90(D)mm	△	
Weight (kg)	0.94	0.39	△	
Allowable momentary power failure period	Within 20ms	Within 20ms	○	
Accessory	Spare fuse: 1 Short chip for applied voltage select terminal: 1	None	×	Fuses are not included in accessories since they are not replaceable, nor are short chip since it is unnecessary to switch operating voltage.

(8) Specifications of A66P

Specification		A66P
Input power supply		100-120VAC+10%-15% (85 to 132VAC)
		200-240VAC+10%-15% (170 to 264VAC)
Input frequency		50/60Hz±5%
Input voltage distortion		Within 5%
Max. input apparent power		95VA
Inrush current		20A within 8ms
Rated output current	5VDC	–
	24VDC	1.2A
Overcurrent protection	5VDC	–
	24VDC	1.7A or more
Efficiency		65% or more
Power indicator		Power LED display
terminal screw size		M3 × 0.5 × 6
Applicable wire size		0.75 to 2mm ²
Applicable solderless terminal		V1.25-4, V1.25-YS4A, V2-S4, V2-YS4A
Applicable tightening torque		68N·cm
External dimensions		250(H) × 75.5(W) × 121(D)mm
Weight (kg)		0.9

(9) Specifications comparison of A67P and Q63P

○: Compatible, △: Partial change required, ×: Incompatible

Specification	A67P	Q63P	Compat- ibility	Precautions for replacement
Input power supply	110VDC (85 to 140VDC)	24VDC+30%-35% (15.6 to 31.2VDC)	×	Consider a change to an external 24 VDC power supply.
Input frequency	—	—	—	
Input voltage distortion	—	—	—	
Max. input apparent power	65W	45W	○	
Inrush current	20A within 8ms	100A within 1ms with input of 24VDC	○	
Rated output current	5VDC	8A	△	Check the current consumption of entire system.
	24VDC	—	—	
Overcurrent protection	5VDC	8.5A or more	○	
	24VDC	—	—	
Overvoltage protection	5VDC	5.5 to 6.5V	○	
	24VDC	—	—	
Efficiency	65% or more	70% or more	○	
Dielectric withstand voltage	Across external DC terminal batch and ground: 500VAC for 1 minute	Between all inputs-LG and all outputs-FG: 500VAC for 1 minute	○	
Noise durability	Noise voltage: 500Vp-p	• By noise simulator of 500Vp-p noise voltage, 1μs noise width and 25 to 60Hz noise frequency	○	
Insulation resistance	Across external DC terminal batch and ground 5MΩ or more by 500VDC insulation resistance tester.	• Between all inputs-LG and all outputs-FG • Between all inputs and LG • Between all outputs and FG 10MΩ or more by 500VDC insulation resistance tester	○	
Power indicator	Power LED display	LED indication (5VDC output: ON)	○	
Terminal screw size	M4 × 0.7 × 6	M3.5 screws	×	Wiring change is required.
Applicable wire size	0.75 to 2mm ²	0.75 to 2mm ²	○	
Applicable solderless terminal	R1.25-4, R2-4 RAV1.25-4, RAV2-4	RAV1.25-3.5, RAV2-3.5	×	Wiring change is required.
Applicable tightening torque	78 to 118N·cm	66 to 89N·cm	×	Tighten within the applicable tightening torque.
External dimensions	250(H) × 55(W) × 121(D)mm	98(H) × 55.2(W) × 90(D)mm	△	
Weight (kg)	0.8	0.33	△	
Allowable momentary power failure period	Within 20ms (with 100 VDC)	Within 10ms with input of 24VDC	○	
Accessory	Spare fuse: 1	None	×	Fuses are not included in accessories since they are not replaceable.

(10) Specifications of A68P

Specification		A68P
Input power supply		100-120VAC+10%-15% (85 to 132VAC)
		200-240VAC+10%-15% (170 to 264VAC)
Input frequency		50/60Hz ± 5%
Input voltage distortion		-
Max. input apparent power		95VA
Inrush current		20A within 8ms
Rated output current	+15VDC	1.2A
	-15VDC	0.7A
Overcurrent protection	+15VDC	1.64A or more
	-15VDC	0.94A or more
Efficiency		65% or more
Power indication		Power LED display
Power ON indication		Contact output
		Switched on if +15VDC output is +14.25V or higher or -15VDC output is -14.25V or lower.
		Min. contact switching load: 5VDC, 10mA Max. contact switching load: 264VAC, 2A (R load)
Terminal screw size		M3 × 0.5 × 6
Applicable wire size		0.75 to 2mm ²
Applicable solderless terminal		V1.25-4, V1.25-YS4A, V2-S4, V2-YS4A
Applicable tightening torque		68N·cm
External dimensions		250(H) × 75.5(W) × 121(D) mm
Weight (kg)		0.9

A power supply of each Q series module that requires power feeding to external is "24VDC". A "15VDC" power supply for Q series module is not required for replacement to the Q series. Note that when utilizing existing modules using such as the QA extension base unit or when using the A series module that requires "15VDC" power supply for replacement to the Q series, substitute the general-purpose switching power supply, whose specifications are shown below, for the A68P. Choose current capacity by the calculation result of current consumption for the entire system used. Substitute the general-purpose switching power supply, whose specifications are shown below, for the A68P. Choose current capacity with the result of calculating the current consumption of entire system to be used.

Specification	General-purpose switching power supply
Voltage	+15VDC ± 3%(14.55V to 15.45V)
	-15VDC ± 3%(-14.55 to -15.45V)
Ripple voltage	50mVp-p or less
Spike voltage	100mVp-p or less
Output voltage limit	Within ± 1V

(11) Specifications comparison between A1NCPU (power supply part) and Q62P

○: Compatible, △: Partial change required, ×: Incompatible

Specification	A1NCPU (power supply part)	Q62P	Compatibility	Precautions for replacement	
Input power supply	100-120VAC+10%-15% (85 to 132VAC)	100-240VAC+10%-15% (85 to 264VAC)	○	The Q62P is wide range type applicable to 100 to 240VAC.	
	200-240VAC+10%-15% (170 to 264VAC)				
Input frequency	50/60Hz ± 5%	50/60Hz ± 5%	○		
Input voltage distortion	5% or less	5% or less	○		
Max. input apparent power	110VA	105VA	○		
Inrush current	20A within 8ms	20A within 8ms	○		
Rated output current	5VDC	5A	3A	△	Check the current consumption of entire system.
	24VDC	0.8A	0.6A	△	
Overcurrent protection	5VDC	5.5A or more	3.3A or more	○	
	24VDC	1.2A or more	0.66A or more	○	
Overvoltage protection	5VDC	5.5 to 6.5V	5.5 to 6.5V	○	
	24VDC	—	—	—	
Efficiency	65% or more	65% or more	○		
Power indicator	Power LED display	LED indication (5VDC output: ON)	○		
Terminal screw size	M4 × 0.7 × 6	M3.5 screws	×	Wiring change is required.	
Applicable wire size	0.75 to 2mm ²	0.75 to 2mm ²	○		
Applicable solderless terminal	R1.25-4, R2-4 RAV1.25-4, RAV2-4	RAV1.25-3.5, RAV2-3.5	×	Wiring change is required.	
Applicable tightening torque	78 to 118N·cm	66 to 89N·cm	×	Tighten within the applicable tightening torque.	
External dimensions	250(H) × 135(W) × 121(D)mm (CPU module integrated type)	98(H) × 55.2(W) × 90(D)mm	△	Changed from the CPU module integrated type to a design for separate selection.	
Weight (kg)	1.65	0.39	△		
Allowable momentary power failure period	Within 20ms	Within 20ms	○		
Noise durability	Noise voltage: 1500Vp-p	<ul style="list-style-type: none"> • By noise simulator of 1500Vp-p noise voltage, 1μs noise width and 25 to 60Hz noise frequency • Noise voltage IEC61000-4-4, 2kV 	○		
Dielectric withstand voltage	Across external AC terminal batch and ground: 1500VAC for 1 minute Across external DC terminal batch and ground: 500VAC for 1 minute	Across inputs/LG and outputs/FG 2830VAC rms/3 cycles (2000 m)	○		
Insulation resistance	Across external AC terminal batch and ground 5MΩ or more by 500VDC insulation resistance tester.	<ul style="list-style-type: none"> • Between all inputs-LG and all outputs-FG • Between all inputs and LG • Between all outputs and FG 10MΩ or more by 500VDC insulation resistance tester	○		
Accessory	Spare fuse: 1 Short chip for applied voltage select terminal: 1	None	×	Fuses are not included in accessories since they are not replaceable, nor are short chip since it is unnecessary to switch operating voltage.	

4.3 Precautions for Power Supply Module Replacement

- (1) Current consumption differs between the Q series and A series modules. Select the power supply module with the result of calculating the current consumption of entire system.
- (2) Applicable wire and crimping terminals for terminal blocks differ between the Q series and the A series. Use the wire and crimping terminals compatible with the specifications.
- (3) Input power supply of the Q61P and Q62P is wide range type applicable to 100 to 200VAC.
The power supply can be used for operating voltage of both 100VAC and 200VAC.
- (4) The large-capacity type power supply Q64PN (8.5A) for the Q series is also available. It is recommended to use it when larger current capacity is necessary.

5 BASE UNIT AND EXTENSION CABLE REPLACEMENT

5.1 List of Alternative Models for Base Unit and Extension Cable

5.1.1 List of alternative models for base unit

A/QnA series models to be discontinued		Q series alternative models	
Product	Model	Model	Remarks (restrictions)
Main base unit	A32B	Q32SB	An extension base unit can be connected. → cannot be connected.
	A35B	Q35B	
	A38B	Q38B	
	A32B-UL	Q33B	Number of I/O slots: 2 slots → 3 slots
	A35B-UL	Q35B	
	A38B-UL	Q38B	
	A32B-E	Q32SB	An extension base unit can be connected. → cannot be connected.
	A35B-E	Q35B	
	A38B-E	Q38B	
	A32B-S1	Q33B	Number of I/O slots: 2 slots → 3 slots
	A38HB	Q38B	
	A38HBEU	Q38B	
Extension base unit	A52B	Q52B	
	A55B	Q55B	
	A58B	Q55B	Q55B × 2 units Number of I/O slots: 8 slots → 5 slots × 2 units
		Q68B	A power supply module is required.
	A62B	Q63B	Number of I/O slots: 2 slots → 3 slots
	A65B	Q65B	
	A68B	Q68B	
	A55B-UL	Q55B	
	A58B-UL	Q55B	Q55B × 2 units Number of I/O slots: 8 slots → 5 slots × 2 units
		Q68B	A power supply module is required.
	A65B-UL	Q65B	
	A68B-UL	Q68B	

Remarks

For replacement of the redundant base units (A32RB/A33RB) and redundant power supply base units (A37RHB/A68RB), refer to the Transition of CPUs in MELSEC Redundant System Handbook (Transition from Q4ARCPU to QnPRHCPU).

.....

5.1.2 List of alternative models for Q series large type base unit

A/QnA series models to be discontinued		Q series alternative models
Product	Model	Model
Main base unit	A35B	Q35BL
	A35B-UL	
	A35B-E	
	A38B	Q38BL
	A38B-E	
	A38B-UL	
	A38HB	
	A38HB-EU	
	A38HB-UL	
Extension base unit	A55B	Q55BL
	A55B-UL	
	A65B	Q65BL
	A65B-UL	
	A68B	Q68BL
	A68B-UL	

5.1.3 List of alternative models for extension cable

A/QnA series models to be discontinued		Q series alternative models	
Product	Model	Model	Remarks (restrictions)
Extension cable	AC06B(-UL)	QC06B	
	AC12B(-UL)	QC12B	
	AC30B(-UL)	QC30B	
	A1SC05NB	QC05B	Parallel mounting is not allowed.
	A1SC07NB	QC06B	Parallel mounting is not allowed. Cable length: 0.7m → 0.6m
	A1SC30NB	QC30B	
	A1SC50NB	QC50B	

5.2 Base Unit and Extension Cable Specifications Comparison

5.2.1 Base unit specifications comparison

(1) Main base unit

(a) Comparisons between A32B(-UL/-E) and Q32SB

Item	Model		Precautions for replacement
	A/QnA series	Q series	
	A32B(-UL/-E)	Q32SB	
Loaded I/O modules	2 can be loaded		Refer to Section 5.3.1 for replacement precautions. When using the upgrade tool (base adapter) with existing mounting holes, use the Q33B. For extension connection, use a main base unit supporting the connection.
Extendability	No extension base unit can be connected.		
Internal current consumption (5VDC)	-	0.09A	
Mounting hole size	φ6 bell-shaped hole (For M5 screw)	M4 screw hole or φ4.5 hole (For M4 screw)	
External dimensions	250(H) × 247(W) × 29(D) mm	98(H) × 114(W) × 18.5(D) mm	
Mounting dimensions to the panel	227 × 200 mm	101 × 80 mm	

(b) Comparisons between A32B-S1 and Q33B

Item	Model		Precautions for replacement
	A/QnA series	Q series	
	A32B-S1	Q33B	
Loaded I/O modules	2 can be loaded	3 can be loaded	Refer to Section 5.3.1 for replacement precautions. The upgrade tool (base adapter) for the A32B-S1 is not available.
Extendability	Extension base units can be connected.		
Internal current consumption (5VDC)	-	0.11A	
Mounting hole size	φ6 bell-shaped hole (For M5 screw)	M4 screw hole or φ4.5 hole (For M4 screw)	
External dimensions	250(H) × 268(W) × 29(D) mm	98(H) × 189(W) × 44.1(D) mm	
Mounting dimensions to the panel	248 × 200 mm	169 × 80 mm	

(c) Comparisons between A35B(-UL/-E) and Q35B

Item	Model		Precautions for replacement
	A/QnA series	Q series	
	A35B(-UL/-E)	Q35B	
Loaded I/O modules	5 can be loaded		Refer to Section 5.3.1 for replacement precautions. The upgrade tool (base adapter) with existing mounting holes is available.
Extendability	Extension base units can be connected.		
Internal current consumption (5VDC)	-	0.11A	
Mounting hole size	φ6 bell-shaped hole (For M5 screw)	M4 screw hole or φ4.5 hole (For M4 screw)	
External dimensions	250(H) × 382(W) × 29(D) mm	98(H) × 245(W) × 44.1(D) mm	
Mounting dimensions to the panel	362 × 200 mm	224.5 × 80 mm	

(d) Comparisons between A38B(-E/-UL)/A38HB/A38HBEU and Q38B

Item	Model		Precautions for replacement
	A/QnA series	Q series	
	A38B(-E/-UL)/A38HB/A38HBEU	Q38B	
Loaded I/O modules	8 can be loaded		Refer to Section 5.3.1 for replacement precautions. The upgrade tool (base adapter) with existing mounting holes is available.
Extendability	Extension base units can be connected.		
Internal current consumption (5VDC)	-	0.12A	
Mounting hole size	φ6 bell-shaped hole (For M5 screw)	M4 screw hole or φ4.5 hole (For M4 screw)	
External dimensions	250(H) × 480(W) × 29(D) mm	98(H) × 328(W) × 44.1(D) mm	
Mounting dimensions to the panel	460 × 200 mm	308 × 80 mm	

(2) Extension base unit (No power supply module required)

(a) Comparisons between A52B and Q52B

Item	Model		Precautions for replacement
	A/QnA series	Q series	
	A52B	Q52B	
Loaded I/O modules	2 can be loaded		Refer to Section 5.3.1 for replacement precautions. The upgrade tool (base adapter) with existing mounting holes is available.
Extendability	Extension base units can be connected.		
Internal current consumption (5VDC)	-	0.08A	
Mounting hole size	φ6 bell-shaped hole (For M5 screw)	M4 screw hole or φ4.5 hole (For M4 screw)	
External dimensions	250(H) × 183(W) × 29(D) mm	98(H) × 106(W) × 44.1(D) mm	
Mounting dimensions to the panel	163 × 200 mm	83.5 × 80 mm	

(b) Comparisons between A55B(-UL) and Q55B

Item	Model		Precautions for replacement
	A/QnA series	Q series	
	A55B(-UL)	Q55B	
Loaded I/O modules	5 can be loaded		Refer to Section 5.3.1 for replacement precautions. The upgrade tool (base adapter) with existing mounting holes is available.
Extendability	Extension base units can be connected.		
Internal current consumption (5VDC)	-	0.10A	
Mounting hole size	φ6 bell-shaped hole (For M5 screw)	M4 screw hole or φ4.5 hole (For M4 screw)	
External dimensions	250(H) × 297(W) × 29(D) mm	98(H) × 189(W) × 44.1(D) mm	
Mounting dimensions to the panel	277 × 200 mm	167 × 80 mm	

(c) Comparisons between A58B(-UL) and two Q55Bs

Item	Model		Precautions for replacement
	A/QnA series	Q series	
	A58B(-UL)	Q55B × 2	
Loaded I/O modules	8 can be loaded	5 units × 2 can be loaded	Refer to Section 5.3.1 for replacement precautions.
Extendability	Extension base units can be connected.		
Internal current consumption (5VDC)	-	0.10A × 2	
Mounting hole size	φ6 bell-shaped hole (For M5 screw)	M4 screw hole or φ4.5 hole (For M4 screw)	
External dimensions	250(H) × 411(W) × 29(D) mm	(98(H) × 189(W) × 44.1(D) mm) × 2	
Mounting dimensions to the panel	391 × 200 mm	(167 × 80 mm) × 2	

(d) Comparisons between A58B(-UL) and Q68B (Power supply module loaded)

Item	Model		Precautions for replacement
	A/QnA series	Q series	
	A58B(-UL)	Q68B	
Loaded I/O modules	8 can be loaded		<ul style="list-style-type: none"> • A power supply module is required. • Refer to Section 5.3.1 for replacement precautions. The upgrade tool (base adapter) with existing mounting holes is available.
Extendability	Extension base units can be connected.		
Internal current consumption (5VDC)	-	0.12A	
Mounting hole size	φ6 bell-shaped hole (For M5 screw)	M4 screw hole or φ4.5 hole (For M4 screw)	
External dimensions	250(H) × 411(W) × 29(D)mm	98(H) × 328(W) × 44.1(D)mm	
Mounting dimensions to the panel	391 × 200mm	306 × 80mm	

(3) Extension base unit (Power supply module loaded)

(a) Comparisons between A62B and Q63B

Item	Model		Precautions for replacement
	A/QnA series	Q series	
	A62B	Q63B	
Loaded I/O modules	2 can be loaded	3 can be loaded	Refer to Section 5.3.1 for replacement precautions. The upgrade tool (base adapter) with existing mounting holes is available.
Extendability	Extension base units can be connected.		
Internal current consumption (5VDC)	-	0.11A	
Mounting hole size	φ6 bell-shaped hole (For M5 screw)	M4 screw hole or φ4.5 hole (For M4 screw)	
External dimensions	250(H) × 283(W) × 29(D) mm	98(H) × 189(W) × 44.1(D) mm	
Mounting dimensions to the panel	218 × 200 mm	167 × 80 mm	

(b) Comparisons between A65B(-UL) and Q65B

Item	Model		Precautions for replacement
	A/QnA series	Q series	
	A65B(-UL)	Q65B	
Loaded I/O modules	5 can be loaded		Refer to Section 5.3.1 for replacement precautions. The upgrade tool (base adapter) with existing mounting holes is available.
Extendability	Extension base units can be connected.		
Internal current consumption (5VDC)	-	0.11A	
Mounting hole size	φ6 bell-shaped hole (For M5 screw)	M4 screw hole or φ4.5 hole (For M4 screw)	
External dimensions	250(H) × 352(W) × 29(D) mm	98(H) × 245(W) × 44.1(D) mm	
Mounting dimensions to the panel	332 × 200 mm	222.5 × 80 mm	

(c) Comparisons between A68B (-UL) and Q68B

Item	Model		Precautions for replacement
	A/QnA series	Q series	
	A68B(-UL)	Q68B	
Loaded I/O modules	8 can be loaded		Refer to Section 5.3.1 for replacement precautions. The upgrade tool (base adapter) with existing mounting holes is available.
Extendability	Extension base units can be connected.		
Internal current consumption (5VDC)	-	0.12A	
Mounting hole size	φ6 bell-shaped hole (For M5 screw)	M4 screw hole or φ4.5 hole (For M4 screw)	
External dimensions	250(H) × 466(W) × 29(D) mm	98(H) × 328(W) × 44.1(D) mm	
Mounting dimensions to the panel	446 × 200 mm	306 × 80 mm	

5.2.2 Comparison of extension cable specifications

Item		Model			Precautions for replacement
		A/QnA series		Q series	
		A main - A extension	AnS main - A extension		
Cable length	0.45m	-	A1SC05NB	QC05B	Refer to Section 5.3.2 for replacement precautions.
	0.6m	AC06B	-	QC06B	
	0.7m	-	A1SC07NB	QC06B	
	1.2m	AC12B	-	QC12B	
	3.0m	AC30B	A1SC30NB	QC30B	
	5.0m	-	A1SC50NB	QC50B	
	10.0m	-	-	QC100B	

5.3 Precautions for Base Unit and Extension Cable Replacement

5.3.1 Precautions for base unit replacement

- (1) When replacing the A/QnA series base unit with the Q series, it is necessary to redo the mounting holes to fix the unit to a control panel, since the two series have different mounting hole size.
- (2) Installation method for the Q series base unit using the existing mounting hole
 - (a) Replacement with the Q series large type base unit
Reprocess of the mounting hole is not required, because the Q series large type base unit and the existing A large type extension base unit are the same dimensions.
 - (b) Replacement with the upgrade tool (base adapter)
When the Q series base unit is installed using the existing mounting hole, reprocess of the hole is not required by using the upgrade tool (base adapter) manufactured by Mitsubishi Electric Engineering Co., Ltd. For the upgrade tool, please consult your local Mitsubishi Electric sales office or representative.
- (3) Internal current consumption (5VDC)
The Q series base unit consumes 5VDC internally as well as CPU modules and I/O modules. When the internal current consumption (5VDC) of entire system is calculated, consider the current consumption of the base unit.
- (4) Extension base unit (type requiring no power supply module)
 - (a) Power supply module
The extension base units (Q5□B and QA1S51B) are supplied 5VDC by the power supply module on the main base unit. Therefore, select the rated output current (5VDC) of the power supply module on the main base unit so that 5VDC on the Q5□B and QA1S51B is satisfied.
 - (b) Voltage drop by an extension cable
The voltage drop in an extension cable occurred, because the extension base units (Q5□B and QA1S51B) are supplied 5VDC through the extension cable. For the voltage drop, refer to the QCPU User's Manual (Hardware Design, Maintenance and Inspection).

5.3.2 Precautions for replacement of extension cable

(1) Overall cable distance of extension cable

An extension cable can be used up to 13.2m for the Q series while it can be used up to 6.6m for the AnS/QnAS series. Select a cable optimum for the system.

(2) Extension cable

The extension cable for replacement may not have the same cable length as the existing A/QnA series extension cable. The AnS series main base unit has two extension connectors (right and left). However, the Q series main base unit has one extension connector (left). When the main base unit and extension base unit are located as below, the existing cable length may be not enough. Consider the position in the control panel and select the cable which has the proper length.

- Configuration example when the base units are located to right and left

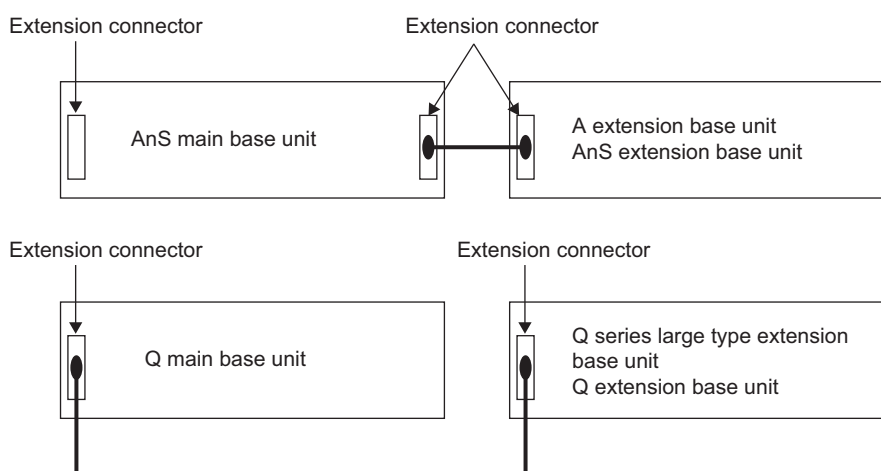

5.4 Q Series Large Type Base Unit Replacement

With this product, when the A/QnA series is replaced with the Q series, the existing wiring can be used in the same installation space as the existing site.

5.4.1 Specifications of Q series large type base unit

Item	Product and model				
	Q series large type main base unit		Q series large type extension base unit		
			(with power supply)		(without power supply) ^{*1}
	Q35BL	Q38BL	Q65BL	Q68BL	Q55BL
Loaded I/O modules	5	8	5	8	5
Extendability	Extension base units can be connected.				
Applicable module	Q series modules, Q series large type I/O modules				
Internal current consumption (5VDC)	0.11A	0.12A	0.11A	0.12A	0.10A
External dimensions	H	240mm			
	W	382mm	480mm	352mm	466mm
	D	110mm			
Weight	1.87kg	2.35kg	1.81kg	2.32kg	1.59kg
Mounting to DIN rail	Unavailable				

*1 The Q series large type extension base units do not support the A58B. Consider the replacement with the Q68BL.

5.4.2 Applicable programmable controller

The following modules are mountable to the CPU slot on the Q series large type base unit. (The Process CPU, Redundant CPU, and safety CPU are not mountable.)

- Universal model QCPU (including High-speed Universal model QCPU) The Q00UJCPU cannot be used.
- MELSECNET/H remote I/O module

5.4.3 Modules that cannot be mounted on the Q series large type base unit

(1) Two-slot module

Example Such as Q64TCRTBW, Q64TCRTBWN, Q64TCTTBW, Q64TCTTBWN, QD70D4, QD70D8, QJ71LP21S-25, and QJ71GP21S-SX

(2) Module on which the Q series large type black cover cannot be attached

- Module whose height exceeds 98mm
- Module with a bracket on its top
- A module with a protrusion, such as a connector, on the bottom
- Module on which the Q7BAT-SET has been mounted

Example Module on which the Q66AD-DG, Q66DA-G, Q68AD-G, Q68RD3-G, Q68TD-G-H02, Q64AD2DA, QD75M1, QD75MH1, QD75M2, QD75MH2, QD75M4, or QD75MH4 has been mounted; or the QJ71WS96 on which the Q7BAT-SET has been mounted.

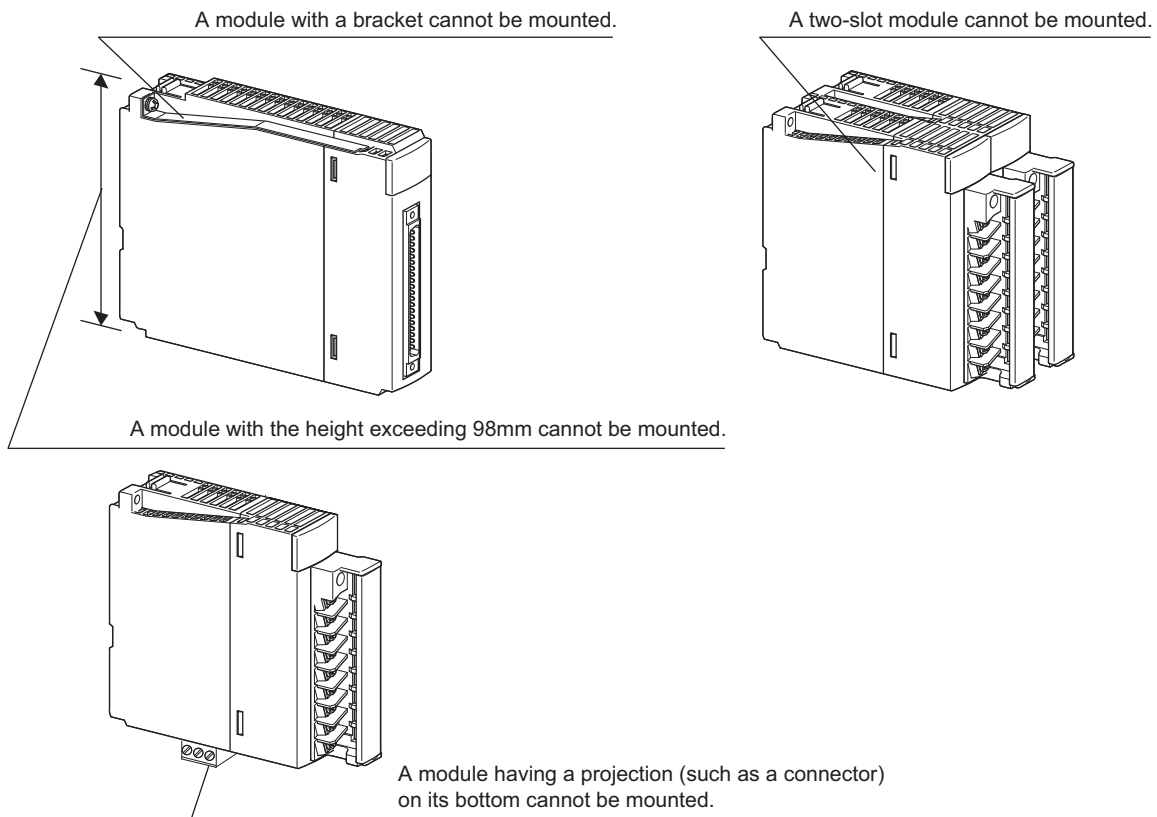

☒ Point

- 1) Use the existing Q series products without change such as a power supply module and CPU module mounted on the Q series large type base unit, and an extension cable connected to the Q series large type base unit. (The Q series large type blank cover is not required for the power supply module or CPU module.)
- 2) The upgrade tool manufactured by Mitsubishi Electric Engineering Co., Ltd. can be mounted on the Q series large type base unit. (The Q series large type blank cover is required for the upgrade tool.) Terminal block type I/O modules other than the Q series large type I/O module can be replaced without writing change.

5.4.4 Precautions for Q series large type base unit replacement

(1) Relay terminal block for power supply wiring

When wiring to the power supply module used in the A/QnA series system is used without change, purchase a relay terminal block and relay the wiring to the power supply module if the wiring to the terminal block of the power supply module mounted on the Q series large type base unit is impossible. For the relay terminal block, refer to the following.

Q Series Large Type Base Unit / I/O Module / Blank Cover User's Manual

(2) Mounting the Q series large type blank cover

Attach the Q series large type blank cover when Q series modules are mounted on the Q series large type base unit. (The cover is not required for modules mounted on the power supply slot and CPU slot.)

(3) Mounting dimensions of Q series large type I/O module

The Q series large type I/O module is 14mm (depth) as large as the A series I/O module having 32 points. Check the depth when the A/QnA series module is replaced.

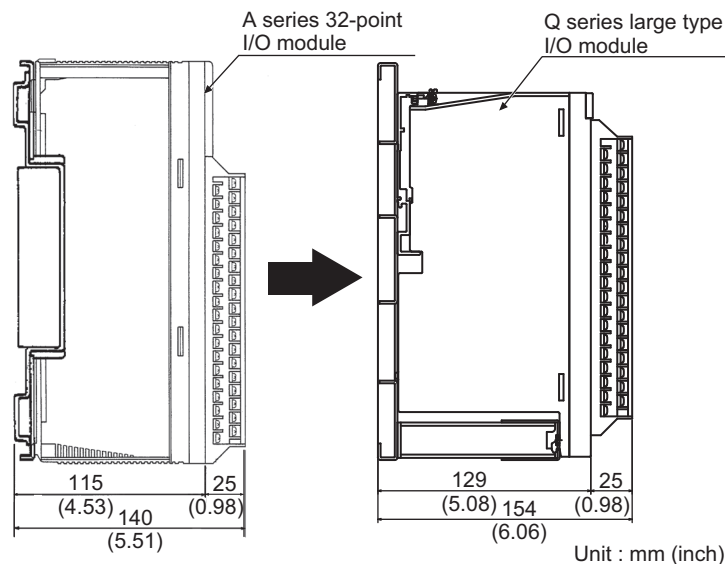

(4) Rated output current of power supply module

The rated output current (24VDC) of power supply module is different between the A series and Q series.

When the output current of power supply module is used as the external power supply of the I/O module, another external power supply may be required in the replacement of the A series modules with Q series modules.

(5) Supporting to the multiple CPU system

The Q series large type main base unit is used, the multiple CPU system cannot be configured. (For the Q series large type extension base unit, it can be used in the multiple CPU system.)

5.5 QA(1S) Extension Base Unit

When replacing the A/QnA series CPU by the Q series using the QA(1S) extension base unit, A/AnS/QnA/QnAS series compatible module can be utilized without change.

Notice	QA extension base unit have been discontinued at the end of June 2020. For details, refer to the technical bulletins (FA-A-0289).
---------------	--

5.5.1 QA(1S) extension base unit specifications

Item	Model					
	QA1S51B	QA1S65B	QA1S68B	QA65B	QA68B	
Number of mountable I/O modules	1	5	8	5	8	
Extendability	Connecting extension base units is not possible.	Connecting extension base units is possible.				
Applicable module	AnS series module			A series module		
5 VDC internal current consumption	0.12A	0.12A	0.11A	0.12A	0.12A	
Mounting hole size	M5 screw hole or ϕ 5.5 hole (For M5 screw)			M5 screw hole or ϕ 5.5 hole (For M5 screw)		
External dimensions	H	130mm			250mm	
	W	100mm	315mm	420mm	352mm	466mm
	D	50.7mm	51.2mm		46.6mm	
Weight	0.23kg	0.75kg	1.00kg	1.60kg	2.00kg	
Accessory	Mounting screw M5 \times 25 3 screws	Mounting screw M5 \times 25 4 screws			-	

5.5.2 Applicable QCPU

The following table shows CPU models that can use the QA(1S) extension base unit as an extension base unit for the QCPU.

	CPU Model	Availability
Universal model QCPU	All CPU models including the High-speed Universal model QCPU	Usable ^{*1}
Universal model Process CPU	Q04UDPVCPU	Unusable
	Q06UDPVCPU	
	Q13UDPVCPU	
	Q26UDPVCPU	
Process CPU	Q12PHCPU	Unusable
	Q25PHCPU	
Redundant CPU	Q12PRHCPU	Unusable
	Q25PRHCPU	
A mode CPU	Q02CPU-A	QA extension base unit: Unusable QA1S extension base unit: Usable
	Q02HCPU-A	
	Q06HCPU-A	

*1 The Universal model QCPU whose serial number (first five digits) is "13102" or later can be used.

5.5.3 Extension cable

Item	Model					
	QC05B	QC06B	QC12B	QC30B	QC50B	QC100B
Cable length	0.45m	0.6m	1.2m	3.0m	5.0m	10.0m
Weight	0.15kg	0.16kg	0.22kg	0.40kg	0.60kg	1.11kg

5.5.4 System configuration

This section explains the system configuration and precautions for use of the QA(1S)6□B type extension base unit.

(1) Connection order of extension base units

When using the Q6□B, QA1S6□B, QA1S51B, and QA6□B together, connect them in the order of the Q6□B, QA1S6□B, QA1S51B, and QA6□B from the nearest position of the main base unit. The QA1S51B is not extendable. When the QA1S51B is used, the QA6□B cannot be used.

(2) Connection order of extension base units upon setting the extension stage number

To use extension base units, it is necessary to set extension stage numbers (1 to 7) with the stage number setting connector.

Set the extension stage number 1 to the connected extension base unit closest to the main base unit, and the following extension stage number (up to 7) to the following extension base units in the connected order.

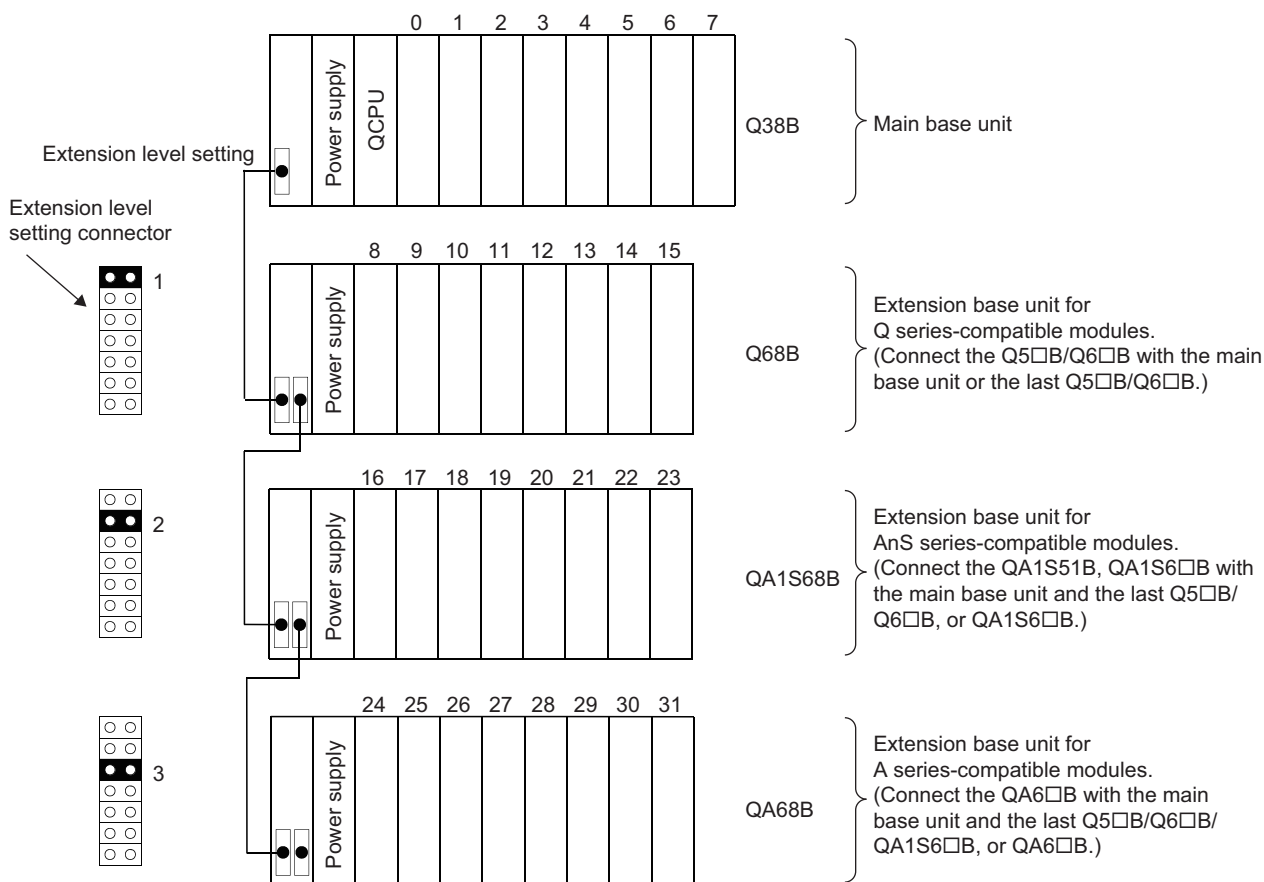

Remarks

- (1) Normal operations of the A series AC input module cannot be guaranteed if there is no base unit on which the A series power supply module is mounted.
Use the A series AC input module in either of the following configurations.
 - Mount the A series AC input module on the QA6□B or QA6ADP+QA6□B.
 - Connect the QA6□B or A6□B to which the QA6ADP is attached as another extension base unit even if the A series AC input module is mounted on the QA6ADP+A5□B.
- (2) The extension base unit for A series with QA conversion adapter mounted and QA1S extension base unit cannot be used together. (When connecting the extension base unit with QA conversion adapter mounted, QA1S extension base unit cannot be connected.)
- (3) When the QA6□B is connected or QA6□B and QA1S6□B are connected with mixed to the Q series extension base unit, GOT cannot be busconnected.
However, when only the QA1S6□B is connected, GOT can be busconnected.
- (4) When using the QA1S6 B extension base unit, a GOT is physically connected to the last of all extension base units. In the stage number setting, however, assign the GOT as a stage next to the last Q B type extension base unit.
Assign the QA1S6 B type extension base unit as a stage next to the GOT.
For details, refer to the GOT1000 Series Connection Manual.

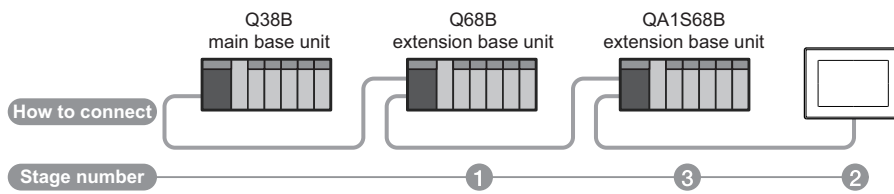

5.5.5 System equipment list

(1) QA1S extension base unit

The following table shows configurable equipment that can be used with the QA1S51B and QA1S6□B extension base unit.

Product	Model			Remarks
Power supply module	A1S61PN,	A1S62PN,	A1S63P	
Input module	A1SX10,	A1SX10EU,	A1SX20,	A1SX20EU,
	A1SX30,	A1SX40,	A1SX40-S1,	A1SX40-S2,
	A1SX41,	A1SX41-S1,	A1SX41-S2,	A1SX42,
	A1SX42-S1,	A1SX42-S2,	A1SX71,	A1SX80,
	A1SX80-S1,	A1SX80-S2,	A1SX81,	A1SX81-S2,
	A1SX82-S1,	A1SX42X		
Output module	A1SY10,	A1SY10EU,	A1SY14EU,	A1SY18A,
	A1SY18AEU,	A1SY22,	A1SY28A,	A1SY40,
	A1SY40P,	A1SY41,	A1SY41P,	A1SY42P,
	A1SY50,	A1SY60,	A1SY60E,	A1SY68A,
	A1SY71,	A1SY80,	A1SY81,	A1SY82,
	A1S42Y			
I/O module	A1SH42,	A1SH42-S1,	A1SX48Y58,	A1SX48Y18
High-speed counter module	A1SD61,	A1SD62,	A1SD62E,	A1SD62D,
	A1SD62D-S1			*1
A/D converter module	A1S64AD,	A1S68AD		
D/A converter module	A1S62DA,	A1S68DAI,	A1S68DAV	
Analog I/O module	A1S63ADA,	A1S66ADA		
Temperature input module	A1S62RD3N,	A1S62RD4N,	A1S68TD	
Temperature control module	A1S62TCTT-S2,	A1S62TCRTBW-S2,	A1S64TCTRT,	
	A1S62TCRT-S2,	A1S62TCTTBW-S2,	A1S64TCTRTBW,	
	A1S64TCTT-S1,	A1S64TCTTBW-S1,		
	A1S64TCRT-S1,	A1S64TCRTBW-S1		
Pulse catch module	A1SP60			
Analog timer module	A1ST60			
Interrupt module	A1SI61			*3
Positioning module	A1SD70			
	A1SD75P1-S3,	A1SD75P2-S3,	A1SD75P3-S3	*1
	A1SD75M1,	A1SD75M2,	A1SD75M3	*1
MELSECNET/MINI-S3 master module	A1SJ71PT32-S3			*1
Intelligent communication module	A1SD51S			*2
MELSECNET, MELSECNET/B local station data link module	A1SJ71AP23Q,	A1SJ71AR23Q,	A1SJ71AT23BQ	
Position detection module	A1S62LS			
PC fault detection module	A1SS91			
Memory card interface module	A1SD59J-S2			
ID interface module	A1SD35ID1,	A1SD35ID2		*2
MELSEC-I/O LINK master module	A1SJ51T64			
B/NET interface module	A1SJ71B62-S3			
S-LINK master module	A1SJ71SL92N			
AS-i master module	A1SJ71AS92			
Blank cover	A1SG60			
Dummy module	A1SG62			

*1 The dedicated instructions in QnA/A series program are not applicable to the QCPU program. Replace them with the FROM/TO instructions.

*2 When using the QA6□B, up to six modules having the same product name can be mounted on the QA6□B.

*3 Only one interrupt module any of QI60, A1SI61, AI61, and AI61-S1 can be used.

(2) QA extension base unit

The following table shows modules that can be used on the QA6□B extension base unit.

Product	Model				Remarks
Power supply module	A61P, A67P, A62PEU	A62P, A66P,	A63P, A68P,	A65P, A61PEU,	
Input module	AX10, AX21, AX40, AX42-S1, AX60-S1, AX80E, AX81-S3,	AX11, AX21EU, AX41, AX50, AX70, AX81, AX81B,	AX11EU, AX31, AX41-S1, AX50-S1, AX71, AX81-S1, AX82	AX20, AX31-S1, AX42, AX60, AX80, AX81-S2,	
Output module	AY10, AY11E, AY13E, AY22, AY40A, AY42-S1, AY50, AY60S, AY71, AY81,	AY10A, AY11AEU, AY13EU, AY23, AY41, AY42-S2, AY51, AY60E, AY72, AY81EP,	AY11, AY11EEU, AY15EU, AY40, AY41P, AY42-S3, AY51-S1, AY60EP, AY80, AY82EP	AY11A, AY13, AY20EU, AY40P, AY42, AY42-S4, AY60, AY70, AY80EP,	
I/O module	A42XY,	AH42			
High-speed counter module	AD61,	AD61S1			*1
A/D converter module	A68AD,	A68AD-S2,	A68ADN,	A616AD	
D/A converter module	A62DA, A616DAV,	A62DA-S1, A616DAI	A68DAV,	A68DAI-S1,	
Temperature-digital converter module	A68RD3, A616TD, A60MXT,	A68RD3N, A60MX, A60MXTN	A68RD4, A60MXR,	A68RD4N, A60MXRN,	
Interrupt module	AI61,	AI61-S1			*3
Positioning module	AD70, AD71S2,	AD70D, AD71S7,	AD71, AD72,	AD71S1, AD778M	
	AD75P1-S3,	AD75P2-S3,	AD75P3-S3		*1
	AD75M1,	AD75M2,	AD75M3		*1
MELSECNET/mini-S3 master module	AJ71PT32-S3,	AJ71T32-S3			*1
Intelligent communication module	AD51,	AD51H,	AD51-S3,	AD51H-S3	*2
Position detection module	A61LS,	A62LS-S5,	A63LS		
PC fault detection module	AS91				
Memory card interface module	AD59,	AD59-S1			
Supersonic linear scale interface module	A64BTL				
ID interface module	AJ71ID1-R4, AD32ID1,	AJ71ID2-R4 AD32ID2			*2
	MELSEC-I/OLINK module	AJ51T64			
B/NET interface module	AJ71B62-S3				
External failure diagnostics module	AD51FD-S3				
Voice output module	A11VC				
Vision sensor module	AS50VS,	AS50VS-GN			
Blanking module	AG60				
Dummy module	AG62				
A-A1S module conversion adapter	A1ADP-XY,	A1ADP-SP			*4

*1 The dedicated instructions in QnA/A series program are not applicable to the QCPU program. Replace them with the FROM/TO instructions.

*2 When using the QA1S51B and QA1S6□B, up to six modules having the same product name can be mounted on the QA1S51B and QA1S6□B.

*3 Only one interrupt module any of QI60, A1SI61, AI61 and AI61-S1 can be used.

*4 For mountable modules, refer to Section 5.6.2.

5.5.6 I/O address for the QA(1S) extension base unit and QA conversion adapter

This section explains I/O address (I/O assignment) when using the QA(1S) extension base unit and QA conversion adapter.

(1) Concept of I/O address when using the QA(1S) extension base unit and QA conversion adapter

I/O address when using the QA(1S) extension base unit and QA conversion adapter can be assigned to either of the following.

- (a) Assign the I/O address of the Q series module to the lowest address and assign that of the A series module to the Q series module I/O address + 1 or later.
- (b) Assign the I/O address of the A series module to the lowest address and assign that of the Q series module to the A series module I/O address + 1 or later.

☒ Point

- (1) I/O address can be assigned by either of the following address orders.
 - (a) Q series module → A series module
 - (b) A series module → Q series module

Note that the CPU module does not start due to an error if the address is assigned in the order of Q series module → A series module → Q series module and vice versa.
 - (2) The QA(1S) extension base unit (QA1S51B, QA1S65B, QA1S68B, QA65B, QA68B) occupies I/O addresses for eight modules. (I/O addresses can also be assigned in individual slot units.)
-

(2) I/O address assignment example

The following explains assignment example to modify the program at minimum by using the QA6□B extension base unit and utilizing the existing A series module without I/O address change.

(a) System configuration example

(Existing system configuration example)

(System configuration example after replacement)

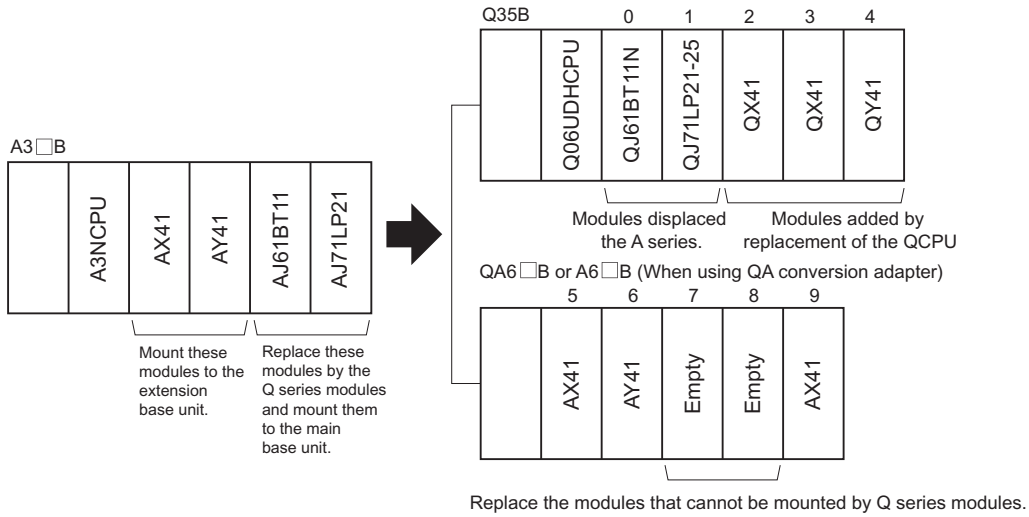

As the CC-Link master/local module, MELSECNET/10(H) network module cannot be utilized, replace them by QCPU-compatible modules.

(b) I/O assignment example of the parameter

(Q35B side)					(QA6□B side)					
		Type	Number of occupied points	Address		Model	Type	Number of occupied points	Address	
Main base unit	0	Intelligent	32 points	100	Extension base unit	5	AX41	Input	32 points	00
	1	Intelligent	32 points	120		6	AY41	Output	32 points	20
	2	Input	32 points	140		7		Empty	32 points	40
	3	Input	32 points	160		8		Empty	32 points	60
	4	Output	32 points	180		9	AX41	Input	32 points	80

The program can be utilized without changing the I/O address of the existing A series module by the I/O assignment above.

5.6 A-A1S Module Conversion Adapter

This section explains the A-A1S module conversion adapter (A1ADP) to leverage the spare part (AnS series module) for the existing A series module.

Notice	AnS series module have been discontinued at the end of September 2014. A1ADP-XY have been discontinued at the end of June 2020. For details, refer to the technical bulletins (FA-A-0142, FA-A-0289).
--------	---

5.6.1 System configuration

Using the A1ADP in the A series extension base unit with the QA extension base unit or QA conversion adapter mounted, the AnS series I/O module/special function module can be mounted.

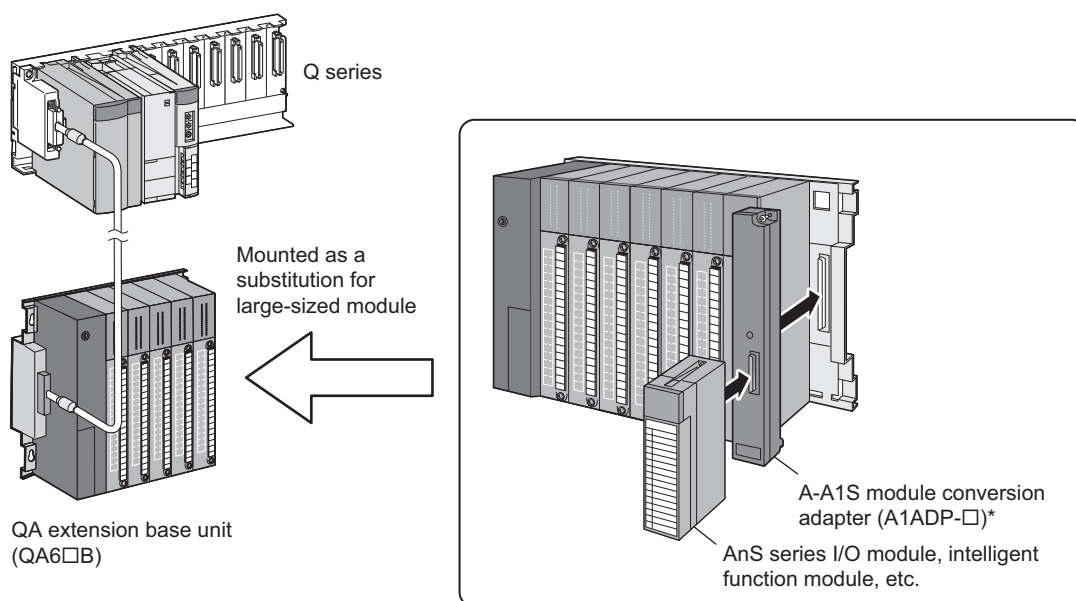

- * The A-A1S conversion module adapter has the following two types according to a type of mounted module.
- A1ADP-XY For AnS series I/O modules
 - A1ADP-SP For AnS series special function modules

☒ Point

- 1) When modules are mounted in either of the following combinations, the operation is not guaranteed.
 - The AnS series special function module is mounted to the A1ADP-XY.
 - The AnS series I/O module is mounted to the A1ADP-SP.
- 2) Refer to "A-A1S Module Conversion Adapter User's Manual" for the CPU module with which the A1ADP can be used and the base unit to which the A1ADP can be mounted.

5.6.2 Modules which can use the A-A1S module conversion adapter (A1ADP)

The following table shows the modules which can be mounted to the base unit using A-A1S module conversion adapter (A1ADP).

Product	Model	Mounting to the A1ADP			Applicable adapter
		QCPU	QnACPU	ACPU	
Input module	A1SX10		○		XY
	A1SX10EU		○		XY
	A1SX20		○		XY
	A1SX20EU		○		XY
	A1SX30		○		XY
	A1SX40		○		XY
	A1SX40-S1		○		XY
	A1SX40-S2		○		XY
	A1SX41		○		XY
	A1SX41-S1		○		XY
	A1SX41-S2		○		XY
	A1SX42		○		XY
	A1SX42-S1		○		XY
	A1SX42-S2		○		XY
	A1SX71		○		XY
	A1SX80		○		XY
	A1SX80-S1		○		XY
	A1SX80-S2		○		XY
	A1SX81		○		XY
	A1SX81-S2		○		XY
A1SX82-S1		○		XY	
Output module	A1SY10		○		XY
	A1SY10EU		○		XY
	A1SY14EU		○		XY
	A1SY18A		○		XY
	A1SY18AEU		○		XY
	A1SY22		○		XY
	A1SY28A		○		XY
	A1SY40		○		XY
	A1SY40P		○		XY
	A1SY41		○		XY
	A1SY41P		○		XY
	A1SY42P		○		XY
	A1SY50		○		XY
	A1SY60		○		XY
	A1SY60E		○		XY
	A1SY68A		○		XY
	A1SY71		○		XY
	A1SY80		○		XY
	A1SY81		○		XY
	A1SY82		○		XY

Mounting to the A1ADP column ○: Mountable ×: Not mountable –: Out of the target

Applicable adapter column XY: A1ADP-XY SP: A1ADP-SP

Product	Model	Mounting to the A1ADP			Applicable adapter
		QCPU	QnACPU	ACPU	
I/O module	A1SH42		○		XY
	A1SH42P		○		XY
	A1SH42-S1		○		XY
	A1SH42P-S1		○		XY
	A1SX48Y58		○		XY
	A1SX48Y18		○		XY
	A1SJ-56DR		×		-
	A1SJ-56DT		×		-
Dynamic scan input module	A1S42X		○		XY
Dynamic output module	A1S42Y		○		XY
Dummy module	A1SG62		○		XY
Interrupt module	A1SI61		○		XY ^{*1}
Power supply module	A1S61PN		×		-
	A1S62PN		×		-
	A1S63P		×		-
Pulse catch module	A1SP60		○		XY
Analog timer module	A1ST60		○		XY
Analog input module	A1S64AD		○		SP
	A1S68AD		○		SP
Analog output module	A1S62DA		○		SP
	A1S68DAI		○		SP
	A1S68DAV		○		SP
Analog I/O module	A1S63ADA		○		SP
	A1S66ADA		○		XY
Temperature input module	A1S62RD3N		○		SP
	A1S62RD4N		○		SP
	A1S68TD		○		SP
Temperature control module	A1S62TCTT-S2		○		SP
	A1S62TCTTBW-S2		○		SP
	A1S62TCRT-S2		○		SP
	A1S62TCTTBW-S2		○		SP
	A1S64TCTT-S1		○		SP
	A1S64TCTTBW-S1		○		SP
	A1S64TCRT-S1		○		SP
	A1S64TCRTBW-S1		○		SP
	A1S64TCTRT		○		SP
	A1S64TCTRTBW		○		SP
High-speed counter module	A1SD61		○		SP
	A1SD62		○		SP
	A1SD62E		○		SP
	A1SD62D		○		SP
	A1SD62D-S1		○		SP
Positioning module	A1SD70		×		-
	A1SD75M1		○		SP
	A1SD75M2		○		SP
	A1SD75M3		○		SP
	A1SD75P1-S3		○		SP
	A1SD75P2-S3		○		SP
	A1SD75P3-S3		○		SP
Position detection module	A1S62LS ^{*2}		○		SP
Intelligent communication module	A1SD51S		○		SP

Mounting to the A1ADP column ○: Mountable ×: Not mountable -: Out of the target

Applicable adapter column XY: A1ADP-XY SP: A1ADP-SP

Product	Model	Mounting to the A1ADP			Applicable adapter
		QCPU	QnACPU	ACPU	
Ethernet module	A1SJ71E71N-B2	×	○	○	SP
	A1SJ71E71N-B5	×	○	○	SP
	A1SJ71E71N3-T	×	○	○	SP
	A1SJ71QE71N-B2	×	○	×	SP
	A1SJ71QE71N-B5	×	○	×	SP
	A1SJ71QE71N3-T	×	○	×	SP
Serial communication module	A1SJ71QC24N	×	○	×	SP
	A1SJ71QC24N-R2	×	○	×	SP
	A1SJ71QC24N1	×	○	×	SP
	A1SJ71QC24N1-R2	×	○	×	SP
MELSECNET/B data link module	A1SJ71AT21B	×	○	○	SP
	A1SJ72T25B		×		—
MELSECNET data link module	A1SJ71AP21	×	○	○	SP
	A1SJ71AR21	×	○	○	SP
MELSECNET, MELSECNET/B local station data link module	A1SJ71AP23Q	○	×	×	SP
	A1SJ71AR23Q	○	×	×	SP
	A1SJ71AT23BQ	○	×	×	SP
MELSECNET/10 network module	A1SJ71LP21	×	×	○	SP
	A1SJ71BR11	×	×	○	SP
	A1SJ71LR21	×	×	○	SP
	A1SJ71QLP21	×	○	×	SP
	A1SJ71QLP21S		×		—
	A1SJ71QBR11	×	○	×	SP
	A1SJ71QLR21	×	○	×	SP
CC-Link master/local module	A1SJ61BT11	×	×	○	SP
	A1SJ61QBT11	×	○	×	SP
MELSECNET/MINI-S3 master module ^{*3}	A1SJ71PT32-S3		○		SP
MELSEC-I/O LINK master module	A1SJ51T64		○		SP
B/NET interface module	A1SJ71B62-S3		○		SP
Computer link module	A1SJ71UC24-R2	×	○	○	SP
	A1SJ71UC24-PRF	×	○	○	SP
	A1SJ71UC24-R4	○ ^{*4}	○	○	SP
S-LINK master module	A1SJ71SL92N		○		SP
AS-i master module	A1SJ71AS92		○		SP
PC fault detection module	A1SS91		○		SP ^{*1}
Memory card interface module	A1SD59J-S2		○		SP
ID interface module	A1SD35ID1		○		SP
	A1SD35ID2		○		SP
MODBUS module	A1SJ71UC24-R2-S2		○		SP
	A1SJ71UC24-R4-S2		○		SP
Profibus-DP interface module	A1SJ71PB92D		○		SP
	A1SJ71PB93D		○		SP
Profibus-FMS interface module	A1SJ71PB96F		○		SP
DeviceNet master module	A1SJ71DN91		○		SP

Mounting to the A1ADP column ○: Mountable ×: Not mountable —: Out of the target

Applicable adapter column XY: A1ADP-XY SP: A1ADP-SP

*1 Note that the types of I/O assignment module and A-A1S module conversion adapter differ.

*2 When the A1ADP-SP with the A1S62LS mounted is used, available sensor (absocoder) models differ. For available models, refer to the "Type A1S62LS User's Manual".

*3 The A1SJ71PT32-S3 was discontinued on September, 2008.

*4 The adapter is mountable only when the multidrop link function is used.

5.6.3 Precautions for using A-A1S module conversion adapter (A1ADP)

This section explains precautions for using the A-A1S module conversion adapter (A1ADP).

(1) The number of mountable modules per base unit

Up to three modules can be mounted to one base unit. Use modules within the allowable number.

(2) 5VDC internal current consumption

When replacing the A series module with the AnS series module, the internal current consumption may increase. At replacement, check that the current consumption of the modules mounted on the base units does not exceed the rated output current of the power supply module used. (Check for internal current consumption of the A-A1S module conversion adapter in (7) Performance specifications.)

(3) Attaching the dustproof cover

Be sure to attach a dustproof cover to prevent a failure or an electric shock caused by foreign matter entering in the module.

(a) AnS series module

Attach the dustproof cover included in the A-A1S module conversion adapter to the AnS series module, and mount the module to the A-A1S module conversion adapter.

(b) A series module

When using the A-A1S module conversion adapter to which A series module is mounted on the right side, attach the following dustproof cover to the module. (Prepare individually.)

Product	Manufacturer	Quantity	Remarks
A55B, 58B I/O dustproof cover	Mitsubishi Electric System & Service Co., Ltd.	1	Same dustproof cover included in the A52B, A55B, and A58B

(4) Depth dimension of the AnS series 32-point I/O connector type module

After replacing the A series 32-point terminal block module by the AnS series 32-point connector type module, the depth dimension may increase (refer to the following figure). Check the depth dimension for the installation site.

Comparison of the dimensions between the A series 32-point terminal block module and the AnS series 32-point connector type module

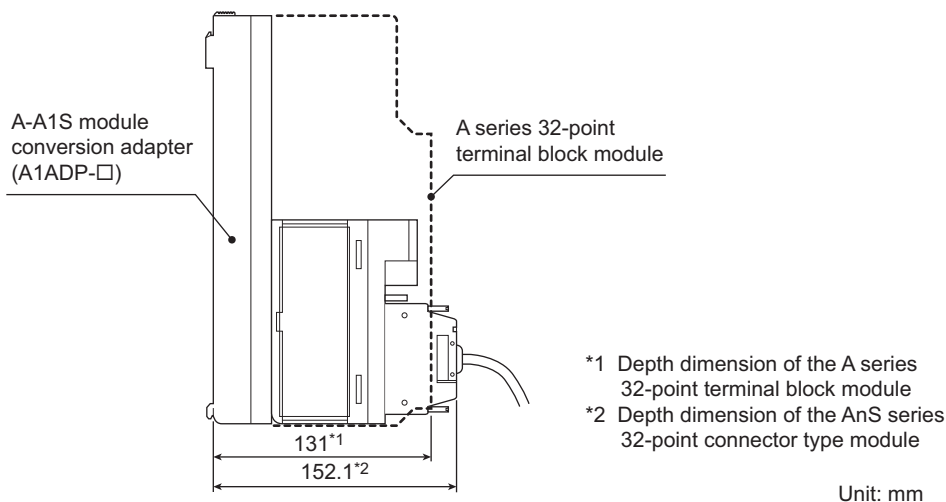

(5) Output module with a fuse

The AnS series output module with a fuse detects fuse blown if external power supply is not input. Use special relay M9084 (error check) at power-on with the external power supply OFF so that fuse blown may not be detected.

(6) Performance specifications

The following table shows performance specifications of the A-A1S module conversion adapter (A1ADP).

Item	Model	
	A1ADP-XY	A1ADP-SP
5 VDC internal current consumption	3.4mA	0mA
External dimensions	250mm(H) × 37.5mm(W) × 35.5mm(D)	
Weight	0.2kg	
Supplied part	Dustproof cover for the AnS series module	

6 MEMORY AND BATTERY REPLACEMENT

6.1 List of Alternative Models for Memory

A/QnA series models to be discontinued		Q series alternative models	
Product	Model	Model	Remarks (restrictions)
Memory cassette (except for A1NCPU)	A3NMCA-0	Unnecessary	<ul style="list-style-type: none"> The QCPU is equipped with built-in program memory. For a file register, standard RAM can be an alternative.
	A3NMCA-2		
	A3NMCA-4		
	A3NMCA-8		
	A3NMCA-16		
	A3NMCA-24		
	A3NMCA-40		
	A3NMCA-56		
	A3AMCA-96		
	A4UMCA-128		
	A4UMCA-8E		
	A4UMCA-32E		
A4UMCA-128E			
Built-in RAM (A2CCPU only)			
Program memory (QnACPU only)			
Memory card (SRAM) (QnACPU only)	Q1MEM-64S	Unnecessary	<ul style="list-style-type: none"> For a file register, standard RAM can be an alternative. If there is a memory shortage or when using a memory card-specific function, select the memory card of the Q series.
	Q1MEM-128S		
	Q1MEM-256S		
	Q1MEM-512S		
	Q1MEM-1MS		
	Q1MEM-2MS		
Memory card (SRAM + E ² PROM) (QnACPU only)	Q1MEM-64SE	Unnecessary	<ul style="list-style-type: none"> The program memory of the Universal model QCPU is a flash ROM. When using a file register, standard RAM can be an alternative.
	Q1MEM-128SE		
	Q1MEM-256SE		
	Q1MEM-512SE		
	Q1MEM-1MSE		
IC-RAM memory (for A1NCPU)	4KRAM	Unnecessary	<ul style="list-style-type: none"> The QCPU is equipped with built-in program memory.
E ² PROM memory	4KEROM	Unnecessary	<ul style="list-style-type: none"> The program memory of the Universal model QCPU is a flash ROM.
EP-ROM memory	4KROM		
	8KROM		
	16KROM		
	32KROM		
	64KROM		

6.2 Precautions for Memory and Battery Replacement

(1) Precaution for memory replacement

If the memory capacity of standard RAM is insufficient (for example, when multiple blocks of extension file registers are used on the Q series), the extended SRAM cassette is required for the High-speed Universal model QCPU, and the SRAM card for the Q series is required for other Universal model QCPUs.

(2) Precaution for battery replacement

The battery for the A series (A6BAT*) should be replaced with the one for Q series (Q6BAT, Q7BAT). (The Q series CPU module comes with the Q6BAT as standard.)

Refer to the users manual of each CPU module for battery life, since it varies depending on the type of CPU module and memory cassette.

* The A6BAT is not a model to be discontinued.

7 PROGRAM REPLACEMENT

This chapter explains how to replace (reuse) the programs and comments of the A and QnA series CPU with the Q series, and precautions for the replacement.

(1) Comparisons between ACPU and QCPU

○: Compatible, △: Partial change required, ×: Incompatible

Item		ACPU specification	QCPU specification and precautions for replacement	Compat-ibility	Reference
Sequence program	Main	<ul style="list-style-type: none"> Main program is required. Sub programs, if included, are switched with the CHG instructions. The SFC is dealt as the microcomputer program of main program. 	[Specification] <ul style="list-style-type: none"> Each program is dealt as one file. [Measure] <ul style="list-style-type: none"> Execute the file setting of PLC parameter. 	△	Section 7.7.10
	Sub 1				
	Sub 2				
	Sub 3				
	SFC				
Microcomputer program	<ul style="list-style-type: none"> A user-created microcomputer program and the microcomputer program of the utility package are available. 	[Specification] <ul style="list-style-type: none"> Creating microcomputer program is not applicable. [Measure] <ul style="list-style-type: none"> Replacing the ACPU user-created microcomputer program with sequence program since the microcomputer program execution is not applicable. For utility packages instructions, correct them equivalent to the corresponding instructions of the QCPU. 	×	–	
Instruction	<ul style="list-style-type: none"> Dedicated instructions for the ACPU (LED instruction, etc.) are available. 	[Specification] <ul style="list-style-type: none"> With "Change PLC type", instructions are converted automatically except some instructions. [Measure] <ul style="list-style-type: none"> The instructions that cannot be converted are changed to SM1255 and SD1255. Therefore, program modification is required. 	△	Section 7.2	
File register	<ul style="list-style-type: none"> Storage area is reserved in a memory cassette. One block is set in 8 k points unit. 	[Specification] <ul style="list-style-type: none"> Data is stored in a standard RAM or memory card. One block is set in 32k points unit. [Measure] <ul style="list-style-type: none"> Execute the file setting of PLC parameter. 	△	Section 7.7.11	
Timer, Counter	<ul style="list-style-type: none"> Timer and counter are processed with the END. 	[Specification] <ul style="list-style-type: none"> Timer and counter are processed when executing an instruction. [Measure] <ul style="list-style-type: none"> Review the programs since the processing timing differs between timer and counter. 	△	Section 7.7.4, Section 7.7.5	

○: Compatible, △:Partial change required, ×: Incompatible

Item	ACPU specification	QCPU specification and precautions for replacement	Compat-ibility	Reference
Parameter	<ul style="list-style-type: none"> Parameters are dedicated for each CPU. 	[Specification] <ul style="list-style-type: none"> Parameters are dedicated for each CPU. [Measure] <ul style="list-style-type: none"> Check and re-set the parameters since specifications and functions differ between the two CPUs. 	△	Section 7.3
Special relay	<ul style="list-style-type: none"> 256 points of M9000 to M9255 are provided. 	[Specification] <ul style="list-style-type: none"> 1800 points of SM0 to SM1799 are provided. [Measure] <ul style="list-style-type: none"> Although automatic conversion is executed for the QCPU replacement, review the points since some specifications differ between the two CPUs. 	△	Section 7.4
Special register	<ul style="list-style-type: none"> 256 points of D9000 to D9255 are provided. 	[Specification] <ul style="list-style-type: none"> 1800 points of SD0 to SD1799 are provided. [Measure] <ul style="list-style-type: none"> Although automatic conversion is executed for the QCPU replacement, review the points since some specifications differ between the two CPUs. 	△	Section 7.5
Comment	<ul style="list-style-type: none"> Comments are managed as a common comment or program original comment. Up to 127k (64k + 63k) bytes of comment can be written to the ACPU. 	[Specification] <ul style="list-style-type: none"> Comments are managed as a common comment or program original comment. Comments are automatically replaced upon PC type change of GX Developer along with the conversion to the QCPU. The comment capacity of the QCPU depends on memory capacity. 	○	–
Writing programs to ROM	<ul style="list-style-type: none"> The ROM operation is executed with the EP-ROM. 	[Specification] <ul style="list-style-type: none"> The Universal model QCPU eliminates the need of replacement selection because the program memory is flash ROM. Boot run of the Universal model QCPU can be executed using an SD memory card. 	△	Section 7.7.12

(2) Comparison between QnACPU and QCPU

○: Compatible, △: Partial change required, ×: Incompatible

Item	QnACPU specification	QCPU specification and precautions for replacement	Compatibility	Reference
Sequence program SFC program	<ul style="list-style-type: none"> Each program is dealt as one file. 	[Specification] <ul style="list-style-type: none"> Each program is dealt as one file. 	○	–
Instruction	<ul style="list-style-type: none"> Dedicated instructions as display (LED) instruction, status latch (SLT) instruction, etc. are available. 	[Specification] <ul style="list-style-type: none"> With “Change PLC type”, instructions are converted automatically except some instructions. [Measure] <ul style="list-style-type: none"> The instructions that cannot be converted are changed to SM1255 and SD1255. Therefore, program modification is required. 	△	Section 7.2
File register	<ul style="list-style-type: none"> Data is stored in a memory card. One block is set in 32k points unit. 	[Specification] <ul style="list-style-type: none"> Data is stored in a standard RAM or memory card. One block is set in 32k points unit. [Measure] <ul style="list-style-type: none"> Review the setting since the number of memory cards differs between the two CPUs. 	△	Section 7.7.11
Parameter	<ul style="list-style-type: none"> Dedicated parameters for each CPU are provided. 	[Specification] <ul style="list-style-type: none"> Dedicated parameters for each CPU are provided. [Measure] <ul style="list-style-type: none"> Check and re-set the parameters since specifications and functions differ between the two CPUs. 	△	Section 7.3
Special relay	<ul style="list-style-type: none"> 1800 points of SM0 to SM1799 are provided. 	[Specification] <ul style="list-style-type: none"> 1800 points of SM0 to SM1799 are provided. [Measure] <ul style="list-style-type: none"> Review the points since some specifications differ between the two CPUs. 	△	Section 7.4
Special register	<ul style="list-style-type: none"> 1800 points of SD0 to SD1799 are provided. 	[Specification] <ul style="list-style-type: none"> 1800 points of SD0 to SD1799 are provided. [Measure] <ul style="list-style-type: none"> Review the points since some specifications differ between the two CPUs. 	△	Section 7.5
Comment	<ul style="list-style-type: none"> Comments are managed as a common comment or program original comment. 	[Specification] <ul style="list-style-type: none"> Comments are managed as a common comment or program original comment. 	○	–
Writing programs to ROM	<ul style="list-style-type: none"> The boot run is executed with program and parameter stored in a memory card. Up to two memory cards can be installed. 	[Specification] <ul style="list-style-type: none"> The boot run is executed with the programs stored in a standard ROM, memory card, or SD memory card upon QCPU replacement. A maximum of one memory card or one SD memory card can be installed. [Measure] <ul style="list-style-type: none"> Execute the boot setting of PLC parameter. 	△	Section 7.7.12

7.1 Program Replacement Procedure

The programs and comments of the A and QnA series can be replaced with the Q series by "Change PLC type" of the GX Developer.

7.1.1 Program conversion procedure from ACPU to QCPU

Program conversion procedure follows the order of (1) → (2) → (3) below.

- (1) Reading process of conversion source data.
- (2) Program conversion from A/QnACPU to QCPU with "Change PLC type".
- (3) Writing process of converted data.

Refer to Section 7.1.2 for details of the change operation.

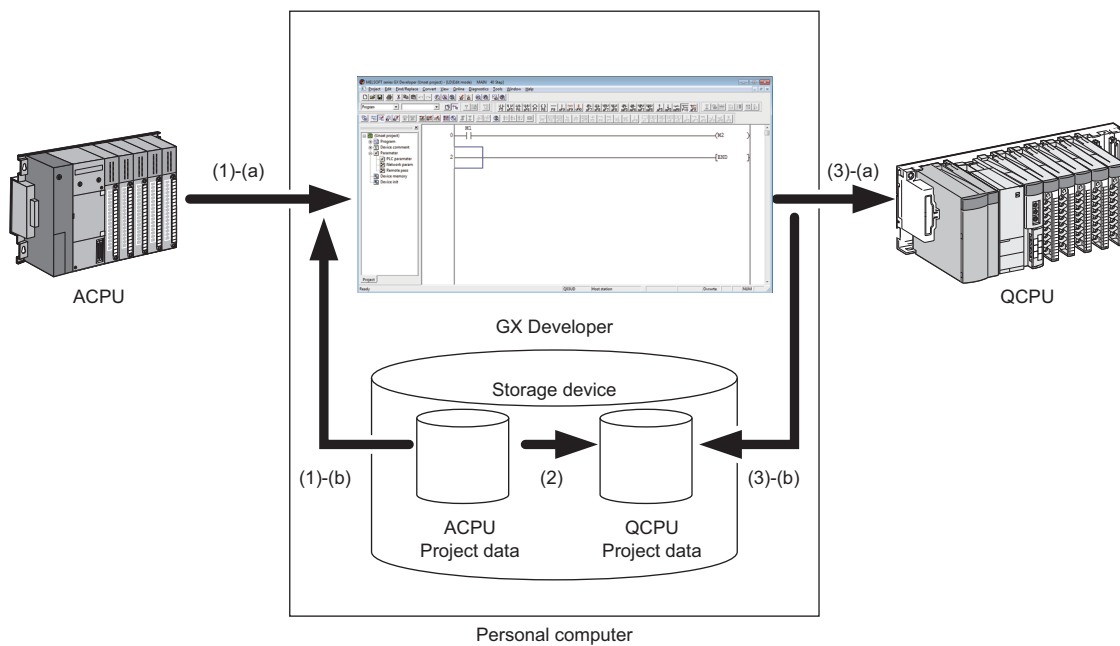
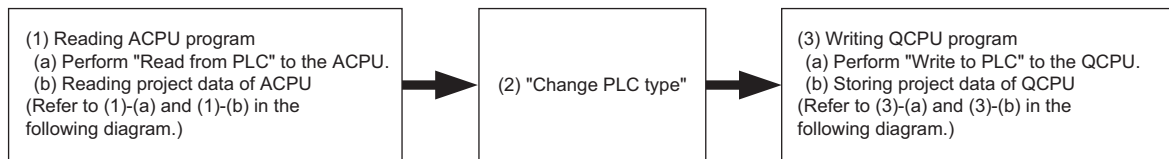

7.1.2 Changing programmable controller type

The function of "Change PLC type" is to reuse data by converting existing data into one of a different PLC series.

This function allows a change of the PLC type for which the read-out data in GX Developer is used. Some instructions that cannot be automatically converted are changed to "OUT SM1255".

Search for these instructions or SM1255 in the converted program and modify the program manually. For intelligent function modules and network modules, review programs and parameters.

(1) Applicable range of conversion from ACPU by the GX Developer

The following table shows the applicable range of conversion from the ACPU to other programmable controllers. As it shows, converting to all the CPU modules is applicable.

Product	Change source programmable controller	Change destination programmable controller		
		A/AnSCPU	QnA/QnASCPU	QCPU
GX Developer	A/QnACPU	○	○	△*1

*1 GX Developer does not allow a change to the PLC type of Universal model high-speed type QCPU.

(2) Operation of GX Developer

(a) Select "Change PLC type" of the "Project" menu.

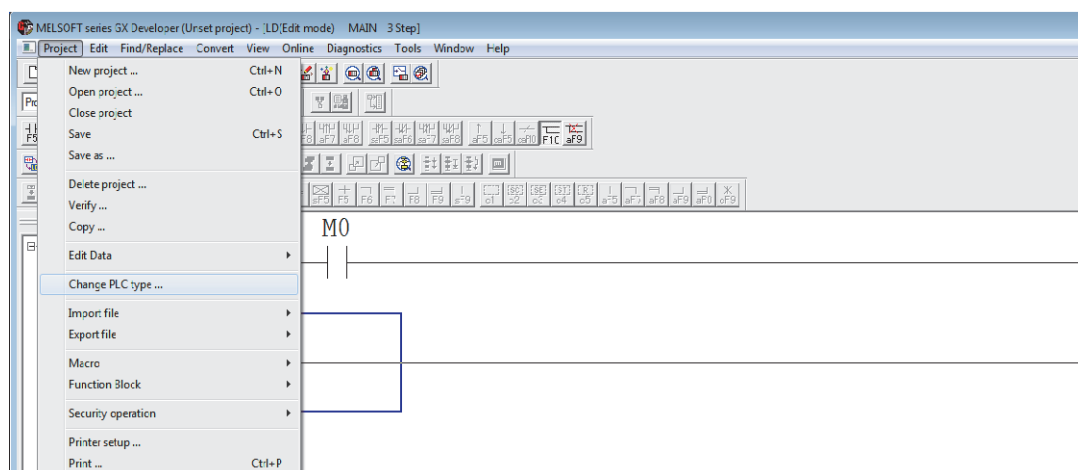

(b) Specify the target programmable controller type in the "Change PLC type" dialog.

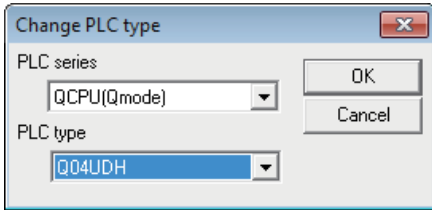

Click the [OK] button after setting "PLC type".

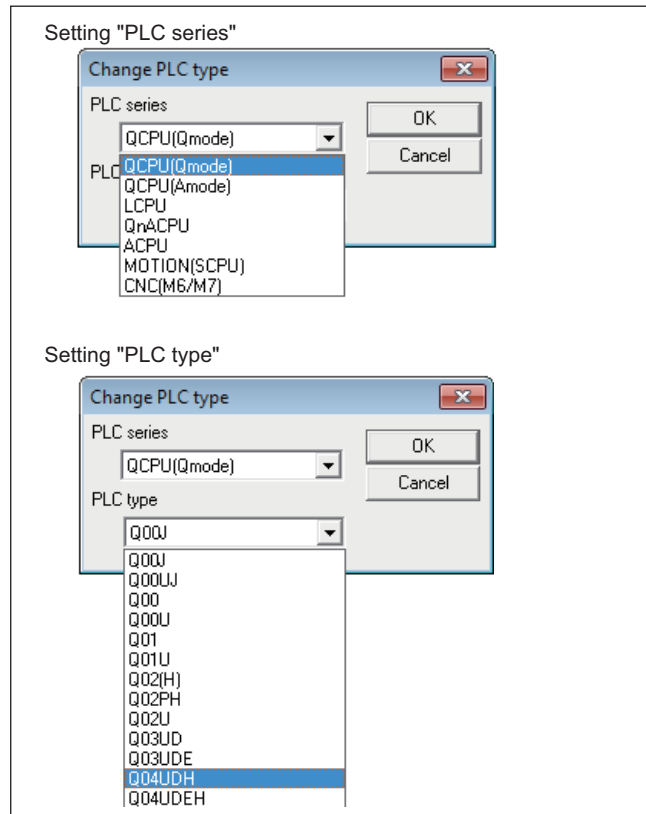

(c) Select the conversion method of special relays/registers.

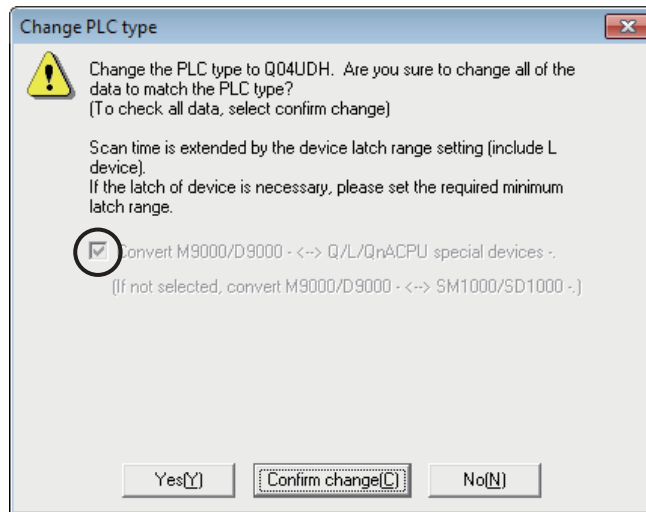

Specify the conversion destination of special relays/registers (ACPU: M9000s/D9000s).

Check the [Convert M9000/D9000←→Q/L/QnACPU special devices]

- Checked: Converted to the Q dedicated device.
- Not Checked: Converted to the A compatible (SM1000s/SD1000s).

Fixed to "Checked" when selecting the Universal model QCPU.

It is recommended to check the box when specifying the device conversion destination.

Click the [Yes] or [Confirm change] button after specifying the device conversion destination to start "Change PLC type".

- [Yes] : The change is executed without intermediate steps of user confirmation.
- [Confirm change] : Asks the user for confirming the changes.

7.1.3 ACPU program conversion ratio

- **Conversion ratio of common instructions (Sequence/basic/application instructions)**

The following table shows the conversion ratio when changing the programmable controller type of the ACPU common instructions to the QCPU.

More than 90% of the common instructions are automatically converted.

Instruction type	Number of instructions	QnUCPU			
		Number of instructions applicable for automatic conversion	Number of instructions requiring manual change	Conversion ratio (reference value)	
Sequence instruction	Contact instruction	6	6	0	100%
	Connection instruction	5	5	0	100%
	Output instruction	6	5	1	83%
	Shift instruction	2	2	0	100%
	Master control instruction	2	2	0	100%
	Termination instruction	2	2	0	100%
	Other instruction	3	3	0	100%
Total number of sequence instruction		26	25	1	96%
Basic instruction	Comparison operation instruction	36	36	0	100%
	Arithmetic operation instruction	40	40	0	100%
	BCD ↔ BIN conversion instruction	8	8	0	100%
	Data transfer instruction	16	16	0	100%
	Program branch instruction	9	9	0	100%
	Program switching instruction	1	0	1	0%
	Link refresh instruction	2	2	0	100%
Total number of basic instruction		112	111	1	99%
Application instruction	Logical operation instruction	18	18	0	100%
	Rotation instruction	16	16	0	100%
	Shift instruction	12	12	0	100%
	Data processing instruction	20	19	1	95%
	FIFO instruction	4	4	0	100%
	Buffer memory access instruction	8	8	0	100%
	FOR to NEXT instruction	2	2	0	100%
	Local station, remote I/O station Access instruction	4	0	4	0%
	Display instruction	5	1	4	20%
	Other instruction	10	2	8	20%
Total number of application instruction		99	82	17	83%
Total number of sequence/basic/application instruction		237	218	19	92%

• **Conversion ratio of dedicated instructions**

The following table shows the conversion ratio when changing the programmable controller type of the ACPU dedicated instructions to the QCPU.

Instruction type	Number of instructions	QnUCPU			
		Number of instructions applicable for automatic conversion	Number of instructions requiring manual change	Conversion ratio (reference value)	
Dedicated instruction (Functional extension)	Direct input/output instruction	3	3	0	100%
	Structured program instruction	6	2	4	33%
	Data operation instruction	6	6	0	100%
	I/O operation instruction	2	1	1	50%
	Real number processing instruction	27	27	0	100%
	Character string processing instruction	25	24	1	96%
	Data control instruction	6	6	0	100%
	Clock instruction	2	2	0	100%
	Extension file register instruction	7	0	7	0%
	Program switching instruction	4	0	4	0%
	Instruction for PID control	3	2	1	67%
Subtotal	91	74	17	81%	
Dedicated instruction (For modules)	Instruction for data link	9	5	4	56%
	Instruction for special function modules	59	0	59	0%
	Subtotal	68	5	63	7%
Total number of dedicated instruction		159	78	81	49%

Remarks

The automatic conversion is applied to the instructions of which equivalent functions and instructions exist in the change destination programmable controller.

Some instructions are not converted for the following causes.

Refer to Section 7.2 Instruction Conversion to change the program manually.

- (1) The change target programmable controller does not have the equivalent functions and instructions.
 - (2) Instructions to specified modules cause to change the module and buffer memory configuration.
 - (3) Multiple instructions with the same name and argument exist.
 - (4) The conversion causes a mismatch in the instructions.
-

7.1.4 Reading (Reusing) other format files

(1) Reading (Reusing) GPPQ/GPPA files to GX Developer

The following explains how to read (reuse) files in the GPPQ/GPPA format other than that of the GX Developer. Follow this procedure to convert them to the file format of the GX Developer.

Point

To read out (reuse) a program of a CPU type that does not support GX Developer, use "A/QnA conversion support tool" in advance to change the PLC type to a CPU type that supports GX Developer. For the operation procedure of the A/QnA conversion support tool, refer to Section 7.1.5

(a) GX Developer operation procedure

Select [Project] → [Import file]
 ├── [Import from GPPQ format file]
 └── [Import from GPPA format file]

(b) Setting screen

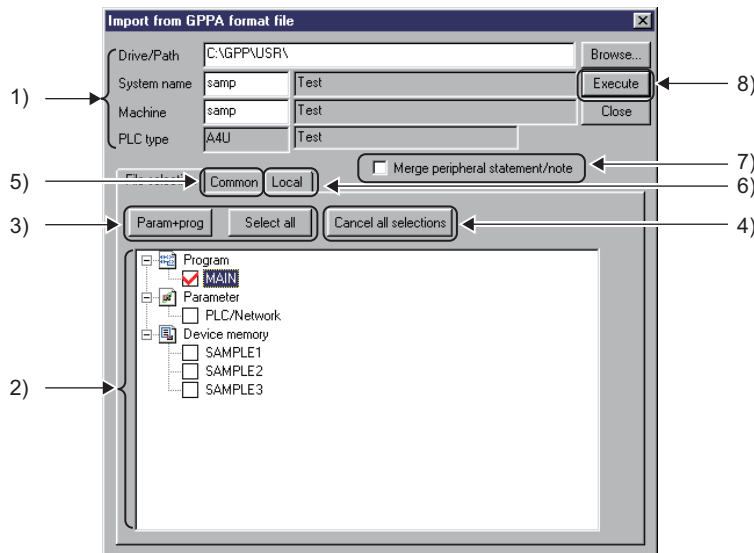

1) Drive/Path, System name, Machine name, PLC type

Designates the location of data created in GPPQ or GPPA format.

Enter the system name and machine name of the data specified in the Drive/Path.

Clicking the [Browse] button shows the dialog box for choosing the system name and machine name. Double-click the file to be read to specify.

2) Source data list

Displays data created in GPPQ or GPPA format.

Check the checkbox of data names to be selected.

For the selected comments, the range of device comment, which can be read with the Common tab or Local tab, are settable.

3) [Param+prog] button/[Select all] button

- [Param+prog] button
Selects only the parameter data and program data of the source data.
- [Select all] button
Selects all data in a source data list.
Comment 2 is selected for the A series, and the device memories of the number of data are displayed.
The first data name is selected for comments and file registers in the QnA series.

4) [Cancel all selections] button

Cancels all the selected data.

5) <<Common>> tab screen (A/QnA series)

Set this when specifying the range for common comments and read data.

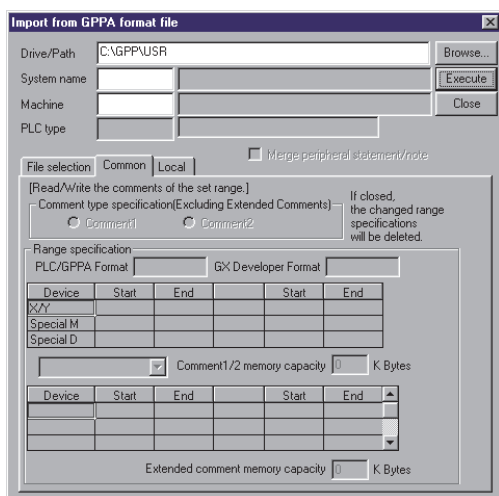

6) <<Local>> tab screen (A/QnA series)

Set this when specifying the range for comments by program and read data.

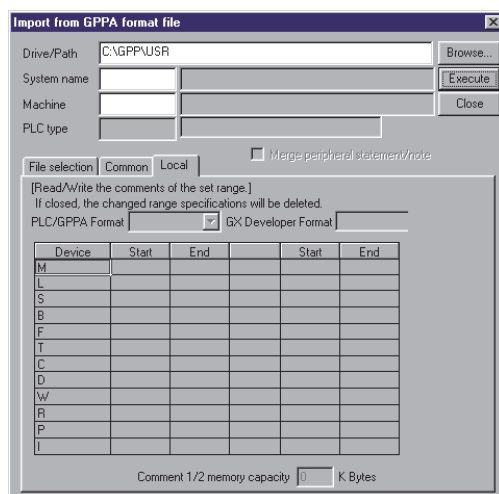

7) Merge peripheral statement/note

For details of merging peripheral statements and notes, refer to the GX Developer Operating Manual.

8) [Execute] button

Click this button after making the setting.

(c) Setting procedure

1) Data selection

- a) Set a drive/path for reading in GPPQ or GPPA format.
- b) Click the [Browse] button to set the system name and machine name of the project to be read.
- c) Check the checkbox of data to be selected with the [Param+prog] button, [Select all] button, or the mouse.
- d) Click the [Execute] button after making necessary settings.

2) Canceling data selection

- a) When canceling the selected data arbitrarily:
Clear the checkmark (P) in the checkbox with the mouse or space key.
- b) When canceling all the selected data:
Click the [Cancel all selection] button.

(d) Precautions for reading the other format files

For A series	
A6GPP, SW0S-GPPA format data	Read data with GX Developer after performing the corresponding format conversion with GPPA. For the operating methods, refer to the Type SW4IVD-GPPA(GPP) Operating Manual.
For data selection	For device comment selection, you may only choose either comment 2 or comment 1.
GPPA format file reading	Deletes the project data on GX Developer and read the other format file. The area in excess of the program capacity is deleted when read. For the programmable controller type which cannot use subprograms, subprograms are deleted when read. When the file includes microcomputer programs edited with other than the SFC program (e.g. SW0SRX-FNUP), they are lost.

For QnA series	
Ladder return positions	Returning places are different between GPPQ and GX Developer. Because of this, if the total of return sources and return destinations exceeds 24 lines in a single ladder block, the program is not displayed properly. Corrective action: Add SM400 (normally ON contact) to adjust the return positions.
For data selection	For the device memory and file register, you may select only one data name for each item.

(2) Procedure for reading files in GX Developer format to GX Works2

The following explains how to appropriately read files in GX Developer format to GX Works2. Follow this procedure to convert the read files to the file format of GX Works2.

(a) GX Works2 operation procedure

[Project] → [Open Other Data] → [Open Other Project]

(b) Setting window

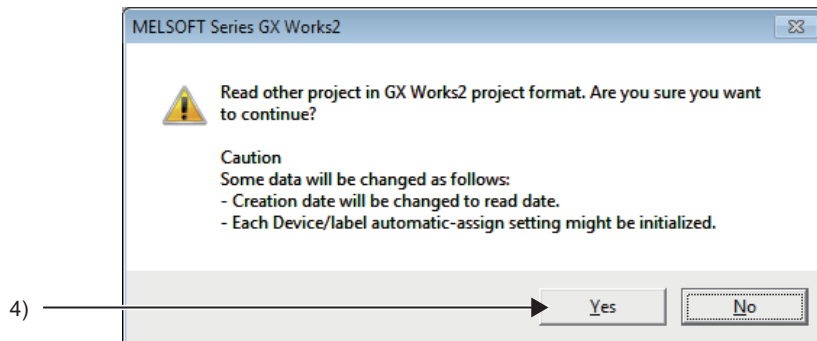
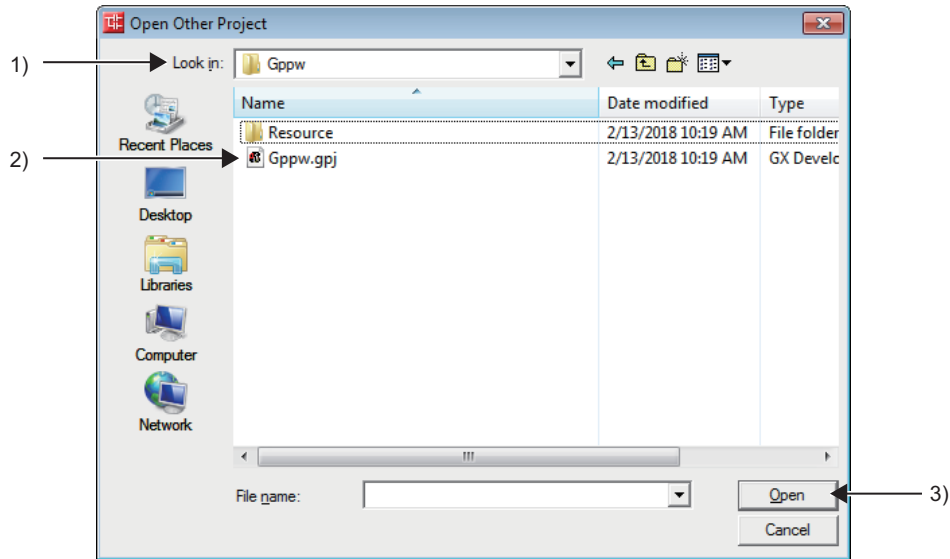

1) Look in

Display the place where the files in GX Developer format are stored and specify the file to be read.

2) Name

Select "*.gpj" for the file extension to use the file as a project file.

3) [Open] button

After selecting the file, click the [Open] button to open the execution window.

4) [Yes] button

Clicking [Yes] button executes the file read.

When the file read is completed, a completion message is displayed.

The file becomes available for GX Works2 operation.

Remarks

- (1) Performing the QCPU programming using GX Developer as a programming tool has following restrictions.

- Model of available CPU module: QCPUs excluding High-speed Universal model QCPU
When this restriction applies, use GX Works2 as a programming tool.

- (2) To use the existing A/QnACPU program with GX Works2, follow the procedure below.

- (a) A/QnACPU program conversion procedure

- 1) Read project data from the existing A/QnACPU using GX Developer and save the file.
↓
- 2) By using "Change PLC type", convert the read A/QnACPU program to a Universal model QCPU, which can be specified with GX Developer.
↓
- 3) Read the converted QCPU program by other format read ([Project] - [Open Other Data] - [Open Other Project]) of GX Works2.
↓
- 4) After that, configure various settings and modify the program using GX Works2.

- (b) Conversion procedure of the difference information embedded Q program (A/QnA-Q conversion support tool)

- 1) Read project data from the existing A/QnACPU using GX Developer and save the file.
↓
- 2) By using "Change PLC type", convert the read A/QnACPU program to a Universal model QCPU, which can be specified with GX Developer, and save it.
↓
- 3) Output the difference information embedded Q program and the review information list using the A/QnA-Q conversion support tool.
↓
- 4) Modify the difference information embedded Q program with GX Developer while referring to the review information list.
↓
- 5) Read the difference information embedded Q program by other format read ([Project] - [Open Other Data] - [Open Other Project]) of GX Works2.
↓
- 6) After that, configure various settings and modify the program using GX Works2.

- (c) Conversion procedure of the MELSECNET (II) local station dedicated module link refresh program (A/QnA-Q conversion support tool)

- 1) Using the A/QnA-Q conversion support tool, set the output type of CPU to a Universal model QCPU and output the MELSECNET (II) local station dedicated module link refresh program.
↓
- 2) Read the MELSECNET (II) local station dedicated module link refresh program by other format read ([Project] - [Open Other Data] - [Open Other Project]) of GX Works2.
↓
- 3) After that, configure various settings and modify the program using GX Works2.

7.1.5 How to reuse a program of a PLC type that does not support GX Developer

Following the steps below with "A/QnA to Q conversion support tool" allows the reuse of a program of a PLC type that does not support GX Developer.

(1) CPU modules that does not support GX Developer

The CPU types listed below does not support GX Developer.

Use "A/QnA to Q conversion support tool" in advance to change the PLC type to a CPU type that supports GX Developer.

- A0J2CPU • A1CPU • A2CPU(-S1) • A3CPU • A73CPU
- A3HCPU • A52GCPU • A3VCPU • A3MCP

(2) Operating procedure

1) Start up "A/QnA to Q conversion support tool".

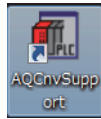

2) Select "A0J2 conversion support tool execute".

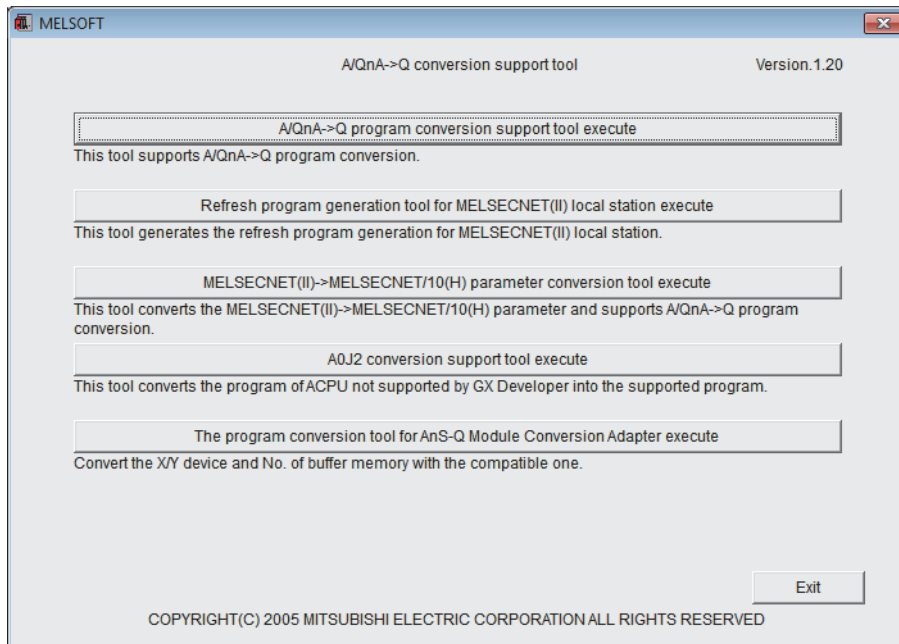

3) Go to "File" and click "New", then select the corresponding PLC type.

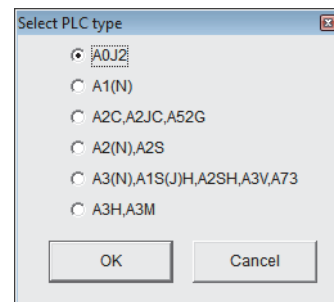
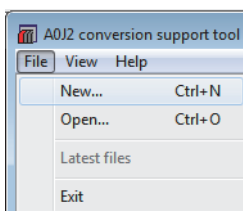

- 4) Go to "Online" and click "Read from PLC", then read the program of the corresponding CPU module.

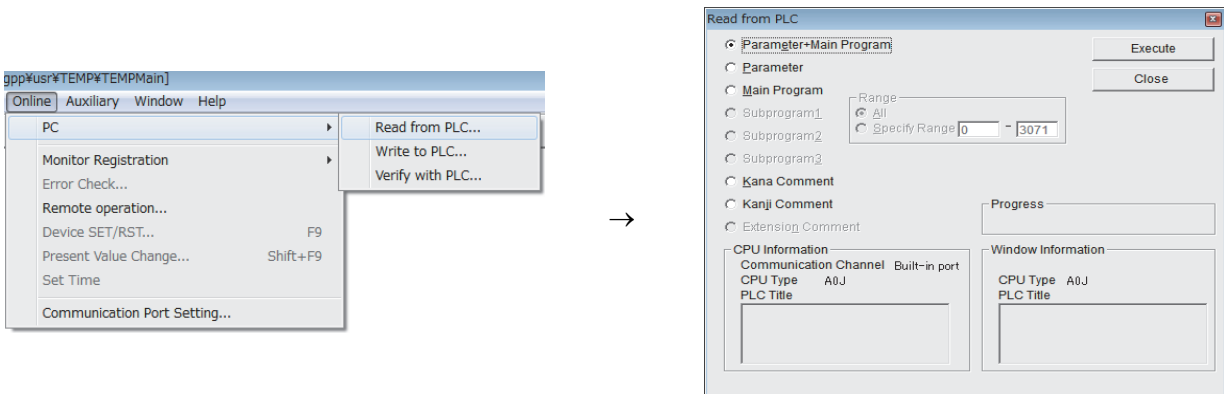

- 5) Go to "Auxiliary" and click "Change PC type", then select a PLC type that supports GX Developer.

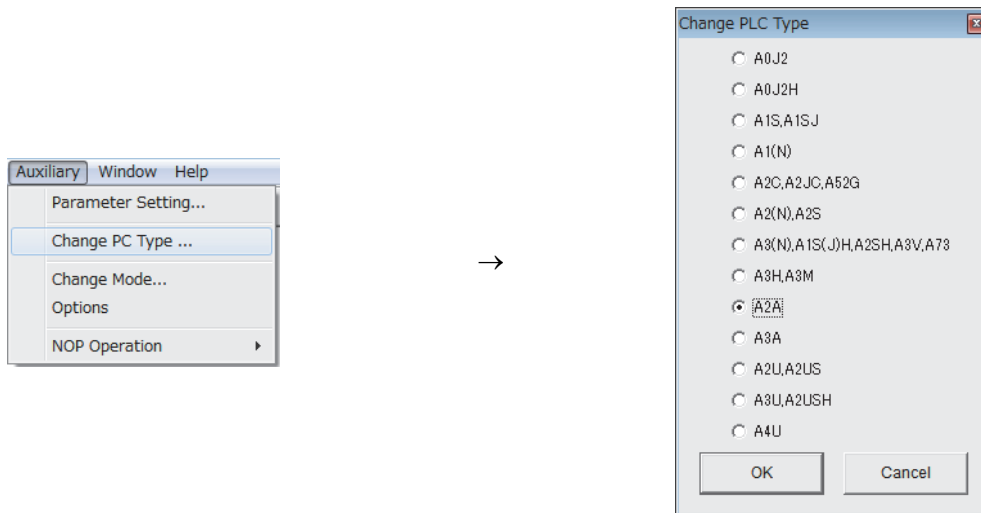

- 6) Go to "File" and select "Save as".
 "System Name" and "Machine Name" defined here constitute the name of another format file, which is mentioned in Section 7.1.4.

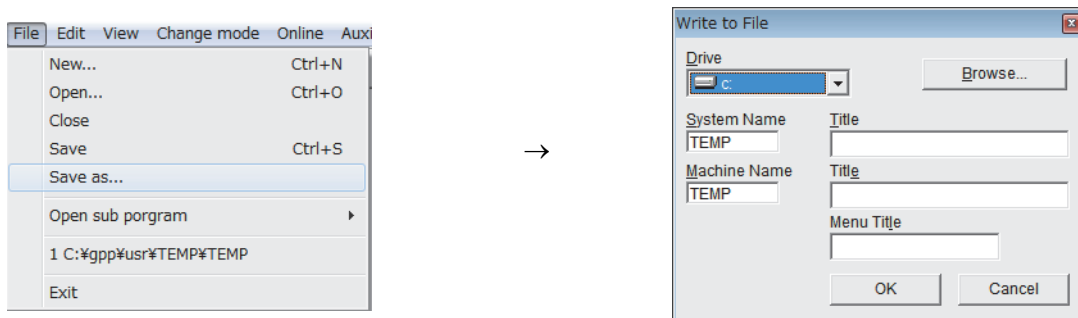

☒ Point

- For details, refer to "A/QnA to Q conversion support tool: A0J2 Conversion Support Tool Operation Guide".
- For details on the A/QnA to Q conversion support tool, please contact your local representative.

7.2 Instruction Conversion

GX Developer enables instruction conversion using "Change PLC type".

The following explains how to process both applicable instructions and not applicable instructions for the conversion.

7.2.1 List of instructions conversion from ACPU to QCPU (Sequence/Basic/Application instructions)

○: Automatic conversion, ×: Manual change required

Contents	ACPU	QnUCPU		Reference section
	Instruction name	Instruction name	Conversion	
BIN 16-bit addition, subtraction	+	+	○	
	+P	+P	○	
	-	-	○	
	-P	-P	○	
BIN 16-bit multiplication, division	*	*	○	
	*P	*P	○	
	/	/	○	
	/P	/P	○	
Ladder block series connection	ANB	ANB	○	
Series connection	AND	AND	○	
16-bit data comparison	AND<	AND<	○	
	AND<=	AND<=	○	
	AND<>	AND<>	○	
	AND=	AND=	○	
	AND>	AND>	○	
	AND>=	AND>=	○	
32-bit data comparison	ANDD<	ANDD<	○	
	ANDD<=	ANDD<=	○	
	ANDD<>	ANDD<>	○	
	ANDD=	ANDD=	○	
	ANDD>	ANDD>	○	
	ANDD>=	ANDD>=	○	
Series connection	ANI	ANI	○	
Conversion from hexadecimal BIN to ASCII	ASC	OUT SM1255	×	Section 7.2.3 (3)
BCD 4-digit addition, subtraction	B+	B+	○	
	B+P	B+P	○	
	B-	B-	○	
	B-P	B-P	○	
BCD 4-digit multiplication, division	B*	B*	○	
	B*P	B*P	○	
	B/	B/	○	
	B/P	B/P	○	
Conversion from BIN data to 4-digit BCD	BCD	BCD	○	
	BCDP	BCDP	○	
Conversion from 4-digit BCD to BIN data	BIN	BIN	○	
	BINP	BINP	○	
Block 16-bit data transfer	BMOV	BMOV	○	
	BMOVP	BMOVP	○	
Bit reset for word devices	BRST	BRST	○	
	BRSTP	BRSTP	○	
Bit set for word devices	BSET	BSET	○	
	BSETP	BSETP	○	
1-bit shift to left of n-bit data	BSFL	BSFL	○	
	BSFLP	BSFLP	○	
1-bit shift to right of n-bit data	BSFR	BSFR	○	
	BSFRP	BSFRP	○	
Sub-routine program calls	CALL	CALL	○	
	CALLP	CALLP	○	
Special format failure checks	CHK	OUT SM1255	×	Section 7.2.3 (3)

○: Automatic conversion, ×: Manual change required

Contents	ACPU	QnUCPU		Reference section
	Instruction name	Instruction name	Conversion	
Bit device output reverse	CHK	OUT SM1255	×	Section 7.2.3 (1)
Main ↔ subprogram switching	CHG	OUT SM1255	×	Section 7.2.3 (2)
Pointer branch instruction	CJ	CJ	○	
Carry flag reset	CLC	OUT SM1255	×	Section 7.2.3 (3)
16-bit data negation transfer	CML	CML	○	
	CMLP	CMLP	○	
Refresh Instruction	COM	COM	○	
BIN 32-bit addition, subtraction	D+	D+	○	
	D+P	D+P	○	
	D-	D-	○	
	D-P	D-P	○	
BIN 32-bit multiplication, division	D*	D*	○	
	D*P	D*P	○	
	D/	D/	○	
	D/P	D/P	○	
Logical products of 32-bit data	DAND	DAND	○	
	DANDP	DANDP	○	
BCD 8-digit addition, subtraction	DB+	DB+	○	
	DB+P	DB+P	○	
	DB-	DB-	○	
	DB-P	DB-P	○	
BCD 8-digit multiplication, division	DB*	DB*	○	
	DB*P	DB*P	○	
	DB/	DB/	○	
	DB/P	DB/P	○	
Conversion from BIN data to 8-digit BCD	DBCD	DBCD	○	
	DBCDP	DBCDP	○	
Conversion from 8-digit BCD to BIN data	DBIN	DBIN	○	
	DBINP	DBINP	○	
32-bit data negation transfer	DCML	DCML	○	
	DCMLP	DCMLP	○	
32-bit BIN data decrement	DDEC	DDEC	○	
	DDECP	DDECP	○	
16-bit BIN data decrement	DEC	DEC	○	
	DECP	DECP	○	
8 → 256-bit decode	DECO	DECO	○	
	DECOP	DECOP	○	
2-word data read from the intelligent/special function module	DFRO	DFRO	○ ^{*1}	
	DFROP	DFROP	○ ^{*1}	
Interrupt disable instruction	DI	DI	○	
Refresh disable	DI	DI	○	
32-bit BIN data increment	DINC	DINC	○	
	DINCP	DINCP	○	
4-bit groupings of 16-bit data	DIS	DIS	○	
	DISP	DISP	○	
32-bit data transfer	DMOV	DMOV	○	
	DMOV P	DMOV P	○	
Logical sums of 32-bit data	DOR	DOR	○	
	DORP	DORP	○	
Left rotation of 32-bit data	DRCL	DRCL	○	Section 7.7.8
	DRCLP	DRCLP	○	Section 7.7.8
Right rotation of 32-bit data	DRCR	DRCR	○	Section 7.7.8
	DRCRP	DRCRP	○	Section 7.7.8
Left rotation of 32-bit data	DROL	DROL	○	Section 7.7.8
	DROL P	DROL P	○	Section 7.7.8

*1 Note that the buffer memory address between Q series and A series may differ.

○: Automatic conversion, ×: Manual change required

Contents	ACPU	QnUCPU		Reference section
	Instruction name	Instruction name	Conversion	
Right rotation of 32-bit data	DRCR	DRCR	○	Section 7.7.8
	DRCRP	DRCRP	○	Section 7.7.8
Left rotation of 32-bit data	DROL	DROL	○	Section 7.7.8
	DROLP	DROLP	○	Section 7.7.8
Right rotation of 32-bit data	DROR	DROR	○	Section 7.7.8
	DRORP	DRORP	○	Section 7.7.8
1-word shift to left of n-word data	DSFL	DSFL	○	
	DSFLP	DSFLP	○	
1-word shift to right of n-word data	DSFR	DSFR	○	
	DSFRP	DSFRP	○	
32 bit data checks	DSUM	DSUM	○	Section 7.7.8
	DSUMP	DSUMP	○	Section 7.7.8
2-word data write to the intelligent/special function module	DTO	DTO	○*1	
	DTOP	DTOP	○*1	
Timing pulse generation	DUTY	DUTY	○	
32-bit data conversion	DXCH	DXCH	○	
	DXCHP	DXCHP	○	
32-bit data non-exclusive logical sum operations	DXNR	DXNR	○	
	DXNRP	DXNRP	○	
32-bit exclusive logical sum operations	DXOR	DXOR	○	
	DXORP	DXORP	○	
Interrupt enable instruction	EI	EI	○	
Link refresh enable	EI	EI	○	
256 → 8-bit encode	ENCO	ENCO	○	
	ENCOP	ENCOP	○	
Sequence program termination	END	END	○	
Main routine program termination	FEND	FEND	○	
Reading oldest data from tables	FIFR	FIFR	○	
	FIFRP	FIFRP	○	
Writing data to the data table	FIFW	FIFW	○	
	FIFWP	FIFWP	○	
Identical 16-bit data block transfers	FMOV	FMOV	○	
	FMOVVP	FMOVVP	○	
FOR to NEXT instruction	FOR	FOR	○	
1-word data read from the intelligent/special function module	FROM	FROM	○*1	
	FROMP	FROMP	○*1	
16-bit BIN data increment	INC	INC	○	
	INCP	INCP	○	
Return from interrupt programs	IRET	IRET	○	
Pointer branch instruction	JMP	JMP	○	
Operation start	LD	LD	○	
BIN 16-bit data comparison	LD<	LD<	○	
	LD<=	LD<=	○	
	LD<>	LD<>	○	
	LD=	LD=	○	
	LD>	LD>	○	
	LD>=	LD>=	○	
BIN 32-bit data comparison	LDD<	LDD<	○	
	LDD<=	LDD<=	○	
	LDD<>	LDD<>	○	
	LDD=	LDD=	○	
	LDD>	LDD>	○	
	LDD>=	LDD>=	○	
Operation start	LDI	LDI	○	
ASCII code display instruction	LED	OUT SM1255	×	Section 7.2.3 (3)

*1 Note that the buffer memory address between Q series and A series may differ.

O: Automatic conversion, x: Manual change required

Contents	ACPU	QnUCPU		Reference section
	Instruction name	Instruction name	Conversion	
Character display instruction	LEDA	OUT SM1255	x	Section 7.2.3 (3)
	LEDB	OUT SM1255	x	Section 7.2.3 (3)
Comment display instruction	LEDC	OUT SM1255	x	Section 7.2.3 (3)
Annunciator reset instruction	LEDR	LEDR	O	
Local station data read	LRDP	OUT SM1255	x	Section 7.2.3 (3)
Local station data write	LWTP	OUT SM1255	x	Section 7.2.3 (3)
Master control set, reset	MC	MC	O	
	MCR	MCR	O	
16-bit data transfer	MOV	MOV	O	
	MOVP	MOVP	O	
Operation result pop	MPP	MPP	O	
Operation result push	MPS	MPS	O	
Operation result read	MRD	MRD	O	
BIN 16-bit data 2's complement	NEG	NEG	O	
	NEGP	NEGP	O	
FOR to NEXT instruction	NEXT	NEXT	O	
No operation (NOP, NOPLF)	NOP	NOP	O	
	NOPLF	NOPLF	O	
Parallel connection	OR	OR	O	
BIN 16-bit data comparison	OR<	OR<	O	
	OR<=	OR<=	O	
	OR<>	OR<>	O	
	OR=	OR=	O	
	OR>	OR>	O	
	OR>=	OR>=	O	
Ladder block parallel connection	ORB	ORB	O	
BIN 32-bit data comparison	ORD<	ORD<	O	
	ORD<=	ORD<=	O	
	ORD<>	ORD<>	O	
	ORD=	ORD=	O	
	ORD>	ORD>	O	
	ORD>=	ORD>=	O	
Parallel connection	ORI	ORI	O	
OUT instruction	OUT	OUT	O*2	
Trailing edge output	PLF	PLF	O	
Leading edge output	PLS	PLS	O	
Print ASCII code instruction	PR	OUT SM1255	x	Section 7.2.3 (3)
Print comment instruction	PRC	OUT SM1255	x	Section 7.2.3 (3)
Left rotation of 16-bit data	RCL	RCL	O	Section 7.7.8
	RCLP	RCLP	O	Section 7.7.8
Right rotation of 16-bit data	RCR	RCR	O	Section 7.7.8
	RCRP	RCRP	O	Section 7.7.8
Return from subroutine program	RET	RET	O	
Remote I/O station data read	RFRP	OUT SM1255	x	Section 7.2.3 (3)
Read from automatic updating buffer memory	RIFR	OUT SM1255	x	Section 7.2.3 (11)
Read from intelligent device station buffer memory (with handshake)	RIRCV	OUT SM1255	x	Section 7.2.3 (11)
Read from intelligent device station buffer memory	RIRD	OUT SM1255	x	Section 7.2.3 (11)
Write to intelligent device station buffer memory (with handshake)	RISEND	OUT SM1255	x	Section 7.2.3 (11)
Write to automatic updating buffer memory	RITO	OUT SM1255	x	Section 7.2.3 (11)
Write to intelligent device station buffer memory	RIWT	OUT SM1255	x	Section 7.2.3 (11)
Network parameter setting	RLPA	OUT SM1255	x	Section 7.2.3 (11)
Automatic refresh parameter setting	RRPA	OUT SM1255	x	Section 7.2.3 (11)

*2 The high-speed timer or retentive timer can also be converted according to the parameter setting.

○: Automatic conversion, ×: Manual change required

Contents	ACPU	QnUCPU		Reference section
	Instruction name	Instruction name	Conversion	
Left rotation of 16-bit data	ROL	ROL	○	Section 7.7.8
	ROLP	ROLP	○	Section 7.7.8
Right rotation of 16-bit data	ROR	ROR	○	Section 7.7.8
	RORP	RORP	○	Section 7.7.8
Bit device reset	RST	RST	○	
Remote I/O station data write	RTOP	OUT SM1255	×	Section 7.2.3 (3)
Pointer branch instruction	SCJ	SCJ	○	
7 segment decode	SEG	SEG	○	
Partial refresh	SEG	SEG	×	
16-bit data search	SER	SER	○	Section 7.7.8
	SERP	SERP	○	Section 7.7.8
Bit device set	SET	SET	○	
	SFL	SFL	○	
16-bit data n-bit left shift	SFLP	SFLP	○	
	SFR	SFR	○	
16-bit data n-bit right shift	SFRP	SFRP	○	
	SFT	SFT	○	
Bit device shift	SFTP	SFTP	○	
	SLT	OUT SM1255	×	Section 7.2.3 (3)
Setting and resetting status latch	SLTR	OUT SM1255	×	Section 7.2.3 (3)
	STC	OUT SM1255	×	Section 7.2.3 (3)
Sequence program stop	STOP	STOP	○	
Setting and resetting sampling trace	STRA	OUT SM1255	×	Section 7.2.3 (3)
	STRAR	OUT SM1255	×	Section 7.2.3 (3)
16-bit data checks	SUM	SUM	○	
	SUMP	SUMP	○	
Microcomputer program	SUB	OUT SM1255	×	
	SUBP	OUT SM1255	×	
1-word data write to the intelligent/ special function module	TO	TO	○*1	
	TOP	TOP	○*1	
4-bit linking of 16-bit data	UNI	UNI	○	
	UNIP	UNIP	○	
Logical products with 16-bit data	WAND	WAND	○	
	WANDP	WANDP	○	
WDT reset	WDT	WDT	○	
	WDTP	WDTP	○	
Logical sums of 16-bit data	WOR	WOR	○	
	WORP	WORP	○	
16-bit data non-exclusive logical sum operations	WXNR	WXNR	○	
	WXNRP	WXNRP	○	
16-bit exclusive logical sum operations	WXOR	WXOR	○	
	WXORP	WXORP	○	
16-bit data conversion	XCH	XCH	○	
	XCHP	XCHP	○	

*1 Note that the buffer memory address between Q series and A series may differ.

7.2.2 List of instruction conversion from ACPU to QCPU (Dedicated instructions)

○: Automatic conversion, ×: Manual change required

Contents	ACPU	QnUCPU		Reference section
	Instruction name	Instruction name	Conversion	
COS ⁻¹ operation on floating point data	ACOS	ACOS	○	
Floating point data addition	ADD	E+	○	
Conversion from hexadecimal BIN to ASCII	ASC	ASC	○	
SIN ⁻¹ operation on floating point data	ASIN	ASIN	○	
TAN ⁻¹ operation on floating point data	ATAN	ATAN	○	
BCD type COS ⁻¹ operation	BACOS	BACOS	○	
BIN 16-bit dead band controls	BAND	BAND	○	
BCD type SIN ⁻¹ operations	BASIN	BASIN	○	
BCD type TAN ⁻¹ operations	BATAN	BATAN	○	
Conversion from 4-digit BCD to decimal ASCII	BCDDA	BCDDA	○	
BCD type COS operations	BCOS	BCOS	○	
BCD 8-digit square roots	BDSQR	BDSQR	○	
Conversion from BIN 16-bit to decimal ASCII	BINDA	BINDA	○	
Conversion from BIN 16-bit to hexadecimal ASCII	BINHA	BINHA	○	
Block move between extension file registers	BMOV	OUT SM1255	×	Section 7.2.3 (4)
Forced end of FOR to NEXT instruction loop	BREAK	BREAK	○	
BCD type SIN operations	BSIN	BSIN	○	
BCD 4-digit square roots	BSQR	BSQR	○	
BCD type TAN operations	BTAN	BTAN	○	
Data linking in byte units	BTOW	BTOW	○	
Block exchange between extension file registers	BXCHR	OUT SM1255	×	Section 7.2.3 (4)
Consecutive display of the same character	CC1	OUT SM1255	×	Section 7.2.3 (11)
	CC2	OUT SM1255	×	Section 7.2.3 (11)
Changing the character color	CCDSP	OUT SM1255	×	Section 7.2.3 (11)
	CCDSPV	OUT SM1255	×	Section 7.2.3 (11)
Special format failure checks	CHK	OUT SM1255	○	Section 7.2.3 (3), (4)
Changing check format of CHK instruction	CHKEND	OUT SM1255	○	Section 7.2.3 (4)
Displaying numerals	CIN0 to CIN9	OUT SM1255	×	Section 7.2.3 (11)
Displaying letters of the alphabet	CINA to CINZ	OUT SM1255	×	Section 7.2.3 (11)
Clearing display of designated area	CINCLR	OUT SM1255	×	Section 7.2.3 (11)
Displaying "-" (hyphen)	CINHP	OUT SM1255	×	
Displaying "-" (minus)	CINMP	OUT SM1255	×	
Displaying "." (period, decimal point)	CINPT	OUT SM1255	×	
Displaying spaces	CINSP	OUT SM1255	×	Section 7.2.3 (11)
Clearing the display area	CLS	OUT SM1255	×	Section 7.2.3 (11)
Clearing the VRAM area	CLV	OUT SM1255	×	Section 7.2.3 (11)
Setting the display mode	CMODE	OUT SM1255	×	Section 7.2.3 (11)
Transferring canvas data to the VRAM area	CMOV	OUT SM1255	×	Section 7.2.3 (11)
Setting normal display for characters	CNOR	OUT SM1255	×	Section 7.2.3 (11)
Displaying the cursor	COFF	OUT SM1255	×	Section 7.2.3 (11)
Designating the character display color	COLOR	OUT SM1255	×	Section 7.2.3 (11)
Reading device comment data	COMRD	COMRD	○	
Displaying the cursor	CON1	OUT SM1255	×	Section 7.2.3 (11)
	CON2	OUT SM1255	×	Section 7.2.3 (11)
COS operations on floating decimal point data	COS	COS	○	
Displaying a canvas screen	CPS1	OUT SM1255	×	Section 7.2.3 (11)
Changing the VRAM display address	CPS2	OUT SM1255	×	Section 7.2.3 (11)
Consecutive display of the same character	CR1	OUT SM1255	×	Section 7.2.3 (11)
	CR2	OUT SM1255	×	Section 7.2.3 (11)
Switching between normal and highlighted display for characters	CRDSP	OUT SM1255	×	Section 7.2.3 (11)
	CRDSPV	OUT SM1255	×	Section 7.2.3 (11)
Setting highlighted display for characters	CREV	OUT SM1255	×	Section 7.2.3 (11)

○: Automatic conversion, ×: Manual change required

Contents	ACPU	QnUCPU		Reference section
	Instruction name	Instruction name	Conversion	
Scrolling the screen	CSCRD	OUT SM1255	×	Section 7.2.3 (11)
	CSCRU	OUT SM1255	×	Section 7.2.3 (11)
Conversion from decimal ASCII to BCD 4-digit data	DABCD	DABCD	○	
Conversion from decimal ASCII to BIN 16-bit data	DABIN	DABIN	○	
Reading clock data	DATERD	DATERD	○	
Writing in clock data	DATEWR	DATEWR	○	
BIN 32-bit dead band controls	DBAND	DBAND	○	
Conversion from BCD 8-digit to decimal ASCII data	DBCDDA	DBCDDA	○	
Conversion from BIN 32-bit to decimal ASCII data	DBINDA	DBINDA	○	
Conversion from BIN 32-bit data to hexadecimal ASCII data	DBINHA	DBINHA	○	
Conversion from decimal ASCII to BCD 8-digit data	DDABCD	DDABCD	○	
Conversion from decimal ASCII to BIN 32-bit data	DDABIN	DDABIN	○	
Conversion from floating point radian to angle	DEG	DEG	○	
Conversion from BIN 32-bit to floating point data	DFLOAT	DFLT	○	
Conversion from hexadecimal ASCII to BIN 32-bit data	DHABIN	DHABIN	○	
Conversion from floating point to BIN 32-bit data	DINT	DINT	○	
Dissociation of random data	DIS	NDIS	○	
Division of floating decimal point data	DIV	E/	○	
Upper and lower limit controls for BIN 32-bit data	DLIMIT	DLIMIT	○	
Direct output	DOUT	OUT	○	
Direct Reset	DRST	RST	○	
32-bit data searches	DSER	DSER	○	
Direct Set	DSET	SET	○	
Conversion from BIN 32-bit to character string	DSTR	DSTR	○	
Bit tests	DTEST	DTEST	○	
Conversion from character string to BIN 32-bit data	DVAL	DVAL	○	
Zone control for BIN 32-bit data	DZONE	DZONE	○	
Displaying characters	EPR	OUT SM1255	×	Section 7.2.3 (11)
	EPRN	OUT SM1255	×	Section 7.2.3 (11)
Writing characters to the VRAM	EPRV	OUT SM1255	×	Section 7.2.3 (11)
	EPRNV	OUT SM1255	×	Section 7.2.3 (11)
Exponent operations on floating decimal point data	EXP	EXP	○	
Sub-routine program output OFF calls	FCALL	FCALL	○	
Bit device output reverse	FF	FF	○	
Conversion from BIN 16 data to floating decimal point	FLOAT	FLT	○	
Reading VRAM data	GET	OUT SM1255	×	Section 7.2.3 (8), (11)
Conversion from hexadecimal ASCII to BIN 16-bit	HABIN	HABIN	○	
Conversion from ASCII to hexadecimal BIN	HEX	HEX	○	
ASCII code conversion of designated character strings	INPUT	OUT SM1255	×	Section 7.2.3 (11)
	INPUT2	OUT SM1255	×	Section 7.2.3 (9)
	INPUT4	OUT SM1255	×	Section 7.2.3 (9)
Conversion from floating decimal point data to BIN 16	INT	INT	○	
Index qualification of a circuit block	IX	OUT SM1255	×	Section 7.2.3 (4)
	IXEND	OUT SM1255	×	Section 7.2.3 (4)
Entering data from number keys	KEY	KEY	×	
Detecting character-string length	LEN	LEN	○	
Upper and lower limit controls for BIN 16-bit data	LIMIT	LIMIT	○	
Setting the cursor position	LOCATE	OUT SM1255	×	Section 7.2.3 (11)
Natural logarithm operations on floating decimal point data	LOG	LOG	○	
Reading word devices in local station	LRDP	OUT SM1255	×	Section 7.2.3 (4)
Writing data to word devices in local station	LWTP	OUT SM1255	×	Section 7.2.3 (4)
Communication with remote terminal modules	MINI	OUT SM1255	×	Section 7.2.3 (10)
Error resetting with remote terminal modules	MINIERR	OUT SM1255	×	Section 7.2.3 (10)
Multiplication of floating decimal point data	MUL	E*	○	
Monitoring PID Control Status	PID57	OUT SM1255	×	Section 7.2.3 (4)
PID control	PIDCONT	PIDCONT	○	
PID control data setting	PIDINIT	PIDINIT	○	
Displaying ASCII characters	PR	OUT SM1255	×	Section 7.2.3 (7), (8), (10), (11)
	PR2	OUT SM1255	×	Section 7.2.3 (9)
Sending data up to 00 _H code	PR4	OUT SM1255	×	Section 7.2.3 (9)

O: Automatic conversion, x: Manual change required

Contents	ACPU	QnUCPU		Reference section
	Instruction name	Instruction name	Conversion	
Displaying ASCII characters	PRN	OUT SM1255	×	Section 7.2.3 (7), (8), (10), (11)
Sending designated number of bytes of data	PRN2	OUT SM1255	×	Section 7.2.3 (9)
	PRN4	OUT SM1255	×	Section 7.2.3 (9)
Writing ASCII characters to the VRAM	PRV	OUT SM1255	×	Section 7.2.3 (11)
	PRNV	OUT SM1255	×	Section 7.2.3 (11)
Writing VRAM data	PUT	OUT SM1255	×	Section 7.2.3 (8), (9), (11)
Reading present value	PVRD1	OUT SM1255	×	Section 7.2.3 (6)
	PVRD2	OUT SM1255	×	Section 7.2.3 (6)
Setting preset data	PVWR1	OUT SM1255	×	Section 7.2.3 (6)
	PVWR2	OUT SM1255	×	Section 7.2.3 (6)
Conversion from floating decimal point angle to radian	RAD	RAD	O	
Remote I/O station data read	RFRP	OUT SM1255	×	Section 7.2.3 (4)
Changing the extension file register block number	RSET	OUT SM1255	×	Section 7.2.3 (4)
Remote I/O station data write	RTOP	OUT SM1255	×	Section 7.2.3 (4)
Block addition and subtraction	SADD	\$+	O	
Comparison between character strings	SCMP	OUT SM1255	×	Section 7.2.3 (4)
SIN operation on floating decimal point data	SIN	SIN	O	
Character string transfers	SMOV	\$MOV	O	
Reading communication status	SPBUSY	OUT SM1255	×	Section 7.2.3 (7), (9), (10)
Forced stop of communication processing	SPCLR	OUT SM1255	×	Section 7.2.3 (7), (9), (10)
Square root operations for floating decimal point data	SQR	SQR	O	
Reading the display status	STAT	OUT SM1255	×	Section 7.2.3 (11)
Conversion from BIN 16-bit to character string	STR	STR	O	
Subtraction of floating decimal point data	SUB	E-	O	
Setting comparison reference data	SVWR1	OUT SM1255	×	Section 7.2.3 (6)
	SVWR2	OUT SM1255	×	Section 7.2.3 (6)
Upper and lower byte exchanges	SWAP	SWAP	O	
TAN operation on floating decimal point data	TAN	TAN	O	
Bit test	TEST	TEST	O	
Linking of random data	UNI	NUNI	O	
Conversion from character string to BIN 16-bit data	VAL	VAL	O	
Data dissociation in byte units	WTOB	WTOB	O	
Program switching	ZCHG0	OUT SM1255	×	Section 7.2.3 (4)
	ZCHG1	OUT SM1255	×	Section 7.2.3 (4)
	ZCHG2	OUT SM1255	×	Section 7.2.3 (4)
	ZCHG3	OUT SM1255	×	Section 7.2.3 (4)
Link refresh of designated network	ZCOM	S.ZCOM	O	Section 7.2.3 (5)
Reading/writing data from/to special function module in MELSECNET/10 remote I/O station	ZNFR	OUT SM1255	×	Section 7.2.3 (5)
	ZNTO	OUT SM1255	×	Section 7.2.3 (5)
Reading from/writing to word devices in the MELSECNET/10 station	ZNRD	J.ZNRD	O	Section 7.2.3 (5)
	ZNWR	J.ZNWR	O	Section 7.2.3 (5)
Zone control for BIN 16-bit data	ZONE	ZONE	O	
Direct read/write of extension file registers in 1-word units	ZRRD	OUT SM1255	×	Section 7.2.3 (4)
	ZRWR	OUT SM1255	×	Section 7.2.3 (4)
Direct read/write of extension file registers in units of bytes	ZRRDB	OUT SM1255	×	Section 7.2.3 (4)
	ZRWRB	OUT SM1255	×	Section 7.2.3 (4)

7.2.3 Instructions that may need a replacement at instruction conversion from ACPU to QCPU

Some instructions are not automatically converted upon the replacement of the ACPU with QCPU. The following table shows the instructions that are not automatically converted. Reviewing the program is recommended.

Item No.	Instruction type		ACPU instruction	Corrective action
(1)	Sequence instruction	Bit device output reverse instruction	CHK	(Counter Measure) Review the program and change manually. (Supplement) Change candidate instruction: [FF] instruction
(2)	Basic instruction	Program switching instruction	CHG	(Counter Measure) Review the program with referring to Section 7.7.10.
(3)	Application instruction	ASCII code conversion instruction	ASC	(Counter Measure) Review the program and change manually. (Supplement) Change candidate instruction: [\$MOV] instruction
		MELSECNET (II), /B Local, Remote I/O station access instruction	LRDP	(Counter Measure) Reprogram for the network modules to use with a QCPU.
			LWTP	
			RFRP	
			RTOP	
		Display instructions (except dedicated instruction)	LED	(Counter Measure) Setting an external display is recommended since the QCPU does not have the LED display function.
			LEDA	
			LEDB	
			LEDC	
		Special format failure checks instruction	CHK	(Counter Measure) Replace the instruction by using an alternative program.
		Status latch instruction	SLT	(Counter Measure)
			SLTR	There is no alternative action.
		Sampling trace instruction	STRA	(Counter Measure)
STRAR	Review the program and change manually. (Supplement) Change candidate instructions: [STRA] → [TRACE] instruction [STRAR] → [TRACER] instruction			
Carry flag instruction	STC	(Counter Measure)		
	CLC	Review the program and change manually. (Supplement) Change candidate instructions: [STC] → [SET SM700] instruction [CLC] → [RST SM700] instruction		
ASCII code print instruction	PR	(Counter Measure)		
Comment print instruction	PRC	Replace the instruction by using an alternative program.*1		

Item No.	Instruction type	ACPU instruction	Corrective action	
(4)	Dedicated instruction	Structured programs instruction	CHK	(Counter Measure)
			CHKEND	Replace the instruction by using an alternative program.
			IX	(Counter Measure)
			IXEND	Replace the instruction by using an alternative program.*1
		MELSEC (II), /B Local, Remote I/O station access instruction	LRDP	(Counter Measure) Reprogram the network modules to use with the QCPU.
			LWTP	
			RFRP	
			RTOP	
		Character string data comparisons instruction	SCMP	(Counter Measure) Review the program and change manually. (Supplement) Change candidate instructions: [LD\$=], [AND\$=], [OR\$=] instruction
		Extension file register instruction	BMOVR	(Counter Measure) Review the program and change manually. (Supplement) Change candidate instructions: [BMOV], [MOV], [RSET] instruction
			BXCHR	
			RSET	
			ZRRD	
			ZRRDB	
ZRWR				
Program switching instruction	ZCHG0	(Counter Measure) Review the program with referring to Section 7.7.10.		
	ZCHG1			
	ZCHG2			
	ZCHG3			
PID control instruction	PID57	(Counter Measure) There is no alternative action.		
(5)	Network dedicated instruction	Network instruction	ZCOM	(Counter Measure) Review the program and change manually. (Supplement) Change candidate instructions: [S (P). ZCOM Jn] or [S (P). ZCOM Un] instruction
			ZNRD	(Counter Measure) Reprogram the network modules to use with the QCPU.
		ZNWR		
		ZNFR		
		ZNTO		

Item No.	Instruction type	ACPU instruction	Corrective action
(6)	Control instruction for high-speed counter module type AD61(S1)	PVWR1	(Counter Measure) Reprogram for the network modules to use with the QCPU.
		PVWR2	
		SVWR1	
		SVWR2	
		PVRD1	
		PVRD2	
(7)	Control instruction for computer link module type AJ71C24 (S3,S6,S8)/AJ71UC24	PRN	
		PR	
		INPUT	
		SPBUSY	
		SPCLR	
(8)	Control instruction for memory card/centronics interface module type AD59	PRN	
		PR	
		GET	
		PUT	
(9)	Control instruction for terminal interface module Type AJ71C21(S1)	PRN2	(Counter Measure) Reprogram for the network modules to use with the QCPU. Restructuring the system is required depending on the module to be used.
		PRN4	
		PR2	
		PR4	
		INPUT2	
		INPUT4	
		GET	
		PUT	
		SPBUSY	
		SPCLR	
(10)	Control instruction for MELSECNET/MINI-S3 master module type AJ71PT32-S3	INPUT	
		PRN	
		PR	
		MINI	
		MINIERR	
		SPBUSY	
		SPCLR	

Item No.	Instruction type	ACPU instruction	Corrective action	
(11)	Special function modules instruction	Control instruction for AD57 (S1) CRT controller module/AD58 LCD controller module	CMODE	(Counter Measure) Reprogram for the network modules to use with the QCPU. Restructuring the system is required depending on the module to be used.
			CPS1	
			CPS2	
			CMOV	
			CLS	
			CLV	
			CSCRU	
			CSCRD	
			CON1	
			CON2	
			COFF	
			LOCATE	
			CNOR	
			CREV	
			CRDSP	
			CRDSPV	
			COLOR	
			CCDSP	
			CCDSPV	
			PRN	
			PR	
			PRNV	
			PRV	
			EPRN	
			EPR	
			EPRNV	
			EPRV	
			CR1	
			CR2	
			CC1	
			CC2	
			CINMT	
			CIN□ (□:0 to 9,A to Z)	
	CINSP			
	CINCLR			
	INPUT			
	GET			
	PUT			
	STAT			
	CC-Link instruction		RIFR	(Counter Measure) Change manually to the same instructions of the Q series.
			RIRCV	
			RIRD	
			RISEND	
RITO				
RIWT				
		RLPA	(Counter Measure)	
		RRPA	Set parameters with GX Works2.	

*1 For details, refer to the following.
FA-A-0068 Precautions for replacing A/QnA (large type) series CPU with Universal model QCPU

7.2.4 Instruction conversion from QnACPU to QCPU

The automatic conversion is applied to the instructions of which equivalent functions and instructions exist in the change target programmable controller.

For instructions that are not automatically converted, consider reviewing the program referring to the unconvertible instructions described in Section 7.2.5.

Re-program for the modules to use with the QCPU, since the specifications of the special function module instructions differ between QCPU compatible modules and QnACPU compatible modules.

☒ Point

When the indirect specification is used, be sure to execute the ADRSET instruction.

7.2.5 Instructions that may need a replacement after conversion from QnACPU to QCPU

Some instructions are not automatically converted upon the replacement of the QnACPU with the QCPU.

The following table shows the instructions that are not automatically converted and their measures. Reviewing the program is recommended.

Instruction type		QnACPU instruction	Corrective action
Application instruction	Index modification of entire ladder	IX	(Counter Measure) Review the program, and change manually.*1 (Supplement) Change candidate instruction: [IX] → [ZPUSH]
		IXEND	Replace the IX instruction with the ZPUSH instruction and set the contents of index modification table to index register. [IXEND] → [ZP.P]
	Modification value specification in index modification of entire ladder	IXDEV	(Counter Measure)
		IXSET	Change the program so that the device offset values specified the IXSET instruction are directly set to the index modification table using the MOV instruction.*1
	Print ASCII code instruction	PR	(Counter Measure)
	Print comment instruction	PRC	Replace the instruction by using an alternative program.*1
	Special format failure checks instruction	CHKST	(Counter Measure)
		CHK	
	Format change instruction for CHK instruction	CHKCIR	Replace the instruction by using an alternative program.*1
		CHKEND	
	Program low-speed execution registration instruction	PLOW	(Counter Measure) • Use the PSCAN instruction instead of this instruction when low-speed execution type programs are replaced with scan execution type programs. • No instruction can be used if low-speed execution type programs are replaced with fixed scan execution type programs.
Program execution status check instruction	PCHK	(Counter Measure) Check a program execution status on the Program monitor list screen of GX Works2. For details, refer to the QCPU User's Manual (Function Explanation, Program Fundamentals).	

Instruction type		QnACPU instruction	Corrective action
Application instruction	Display instruction	LED	(Counter Measure)
		LEDC	Setting an external display is recommended since the QCPU does not have the LED display function.
	Status latch instruction	SLT	(Counter Measure)
		SLTR	There is no alternative action.
	Sampling trace instruction	STRA	(Counter Measure)
		STRAR	Review the program and change manually. (Supplement) Change candidate instructions: [STRA] → [TRACE] instruction [STRAR] → [TRACER] instruction
	Program trace instruction	PTRA	(Counter Measure)
		PTRAR	There is no alternative action.
		PTRAEXE	
	Other instruction	EROMWR	(Counter Measure) Review the program and change manually. (Use the ATA card as a memory card.) (Supplement) Change candidate instruction: [EROMWR] → [FWRITE] instruction
ASCII code print instruction	PR	(Counter Measure) The High Performance model allows the use of this instruction.	
Comment print instruction	PRC	For the Universal model model QCPU, refer to the technical bulletin (No.FA-A-0068).	
PID control instruction		PID57	(Counter Measure) There is no alternative action.
Special function modules instruction Example: G. INPUT, G. PRN, etc.		G (P). [Instruction name]	(Counter Measure) Reprogram for the special function modules to use with the QCPU.

*1 For details, refer to the following.
FA-A-0068 Precautions for replacing A/QnA (large type) series CPU with Universal model QCPU

7.3 Precautions for Parameter Replacement

7.3.1 Conversion from ACPU to QCPU

This section explains the parameter conversion upon replacement of the ACPU programs with the QCPU.

<Compatibility>

○: Common item between ACPU and QCPU, that can be converted directly.

△: Item that requires re-setting after the conversion, since the functions/specifications are partially different

×: Item to be deleted, since there is no common item between the ACPU and QCPU

Confirm the parameters after the conversion, and correct/re-set as required.

Name		Compatibility	Remarks	
Memory capacity	Sequence program capacity	△	No need to care about the program capacity.	
	Microcomputer program capacity	×	No microcomputer program is available.	
	Comment capacity	△	Not required, since comments can be created for all devices.	
	File register capacity	△	Resetting is required since the specifications are different.	
PLC RAS setting	WDT setting	△	This becomes default (200ms).	
	Operation mode when there is an error	△	This becomes default (All stop).	
	Annunciator display mode	×	No compatible function is available.	
PLC system setting	RUN - PAUSE contact	△	Re-setting is required.	
	Output mode at STOP to RUN	△	This becomes default (Output before STOP).	
	Data communications request batch processing	△	Use the COM instruction as necessary. Set the service processing setting in the PLC parameter.	
	Interrupt counter setting	△	Re-setting is required.	
I/O assignment		△	Reviewing is required for the base unit with other than 8 slots.	
Device setting	Number of device points		○ This resets to default. Correcting program is not required, since the device points are more than those of ACPU.	
	Latch range	Latch relay L	○	M and L are different devices. "L" on the program is converted to "L".
		Data register D	○	
		Link relay B	○	
		Link register W	○	
		Low-speed timer	△	Converted as one device. Reviewing is required, since all the range from lowest device No. to highest device No. is included in the latch range.
		High-speed timer		
		Extension low-speed timer		
		Extension high-speed timer		
		Retentive timer	△	Converted as one device. Reviewing is required, since all range from lowest device No. to highest device No. is included in the latch range.
Extension retentive timer				
Counter	△	Converted as one device. Reviewing is required, since the latch range covers all range from lowest device No. to highest device No.		
Extension counter				
Network parameter	MELSECNET (II), /B		×	Parameters are deleted, since the QCPU is not compatible with the MELSECNET (II), /B.
	MELSECNET/10 (H)		○	For AnUCPU, converted to the MELSECNET/10 mode. Parameter re-setting is required for the AnNCPU and AnACPU.
	MELSECNET/MINI		×	Parameters are deleted, since the QCPU is not compatible with the MELSECNET/MINI.

7.3.2 Conversion from QnACPU to QCPU

This section explains the parameter conversion upon replacement of the QnACPU program with the QCPU.

The symbols in the table indicate the following meanings:

<Compatibility>

○: Common item between QnACPU and QCPU, therefore can be converted directly

△: Item that requires re-setting after the conversion, since the functions/specifications are partially different

×: Item to be deleted, since there is no common item between the QnACPU and QCPU

Confirm the parameters after the conversion, and correct/re-set as required.

Name		Compatibility	Remarks	
PLC name setting	Label	○		
	Comment	○		
PLC system setting	Timer limit setting	Low speed	○	
		High speed	○	
	RUN-PAUSE contact	RUN	○	
		PAUSE	○	
	Remote reset		○	
	Output mode at STOP to RUN		○	
	Common pointer No.		○	
	General data processing		△	Use the COM instruction as necessary. Set the service processing setting in the PLC parameter.
	Number of empty slots		○	
	System interrupt setting	Interrupt counter setting No.	△	Re-setting is required.
		I28 Fixed scan interval	○	
I29 Fixed scan interval		○		
I30 Fixed scan interval		○		
I31 Fixed scan interval		○		
PLC file setting	File register	△	Confirmation is required, since the usable target memory is changed.	
	Comment file used in a command	△	Confirmation is required, since the usable target memory is changed.	
	Device initial value	△	Confirmation is required, since the usable target memory is changed.	
	File for local device	△	Confirmation is required, since the usable target memory is changed.	
Device setting	Input relay	○		
	Output relay	○		
	Internal relay	○		
	Latch relay	○		
	Link relay	○		
	Annunciator	○		
	Link special relay	○		
	Edge relay	○		
	Step relay	○		
	Timer	○		
	Retentive timer	○		
	Counter	○		
	Data register	○		
	Link register	○		
	Link special register	○		
Total of device	○			

		Name	Compatibility	Remarks
PLC RAS setting	WDT setting	WDT setting	○	
		Initial execution monitoring time	○	
		Low speed execution monitoring time	×	The Universal model QCPU does not support a low speed program.
	Error check	Carry out battery check	○	
		Carry out fuse blown check	○	
		Carry out I/O module comparison	○	
	Operation mode when there is an error	Computation error	○	
		Expanded command error	○	
		Fuse blown	○	
		I/O module comparison error	○	
		Special module access error	○	The name changes to "Intelligent module program execution error".
		Memory card access error	○	
		Memory card operation error	○	
		Constant scanning	○	
	Annunciator display mode	F No. display	×	The QCPU does not incorporate this display function.
		Comment display	×	The QCPU does not incorporate this display function.
		Occurrence time	×	The QCPU does not incorporate this display function.
	Break down history	Drive	○	The Universal model QCPU does not have this setting because the storage destination is fixed.
		File name	○	
		History No.	○	
	Low speed program execution time	×	The Universal model QCPU does not support a low speed program.	
I/O assignment			△	Reviewing is required if the QCPU base unit has other than 8 slots.
Boot file setting			○	
Program setting			○	
SFC setting	SFC program start mode		○	
	Start conditions		○	
	Output mode when the block is stopped		○	
Network parameter	MELSECNET (II), /B		×	Parameters are deleted, since the QCPU is not compatible with the MELSECNET (II), /B.
	MELSECNET/10 (H)		○	Converted to the MELSECNET/10 mode.
	MELSECNET/MINI		×	Parameters are deleted, since the QCPU is not compatible with the MELSECNET/MINI.
	CC-Link		○	
	Ethernet		○	The "Use the KeepAlive" of "TCP Existence confirmation setting" in the "Ethernet operations" is automatically set.

7.4 Special Relay Replacement

The special relay is an internal relay that has a set application in a programmable controller.

This section explains how to replace special relays when replacing the ACPU programs with QCPU programs.

For the contents of the relays and the handling of the special relays of the A/QnACPU and QCPU, refer to the QCPU User's Manual (Function explanations, Program fundamentals) and QCPU Programming Manual (Common Instructions).

7.4.1 Replacing the ACPU with the QCPU

The QCPU uses a different special relay from the one for the ACPU.

With "Change PLC type", the automatic conversion is applied to the replacement of the ACPU special relay (M9000 and after) with the QCPU special relay (SM). (Refer to Section 7.1.2.)

Point

- 1) Some ACPU special relays are not compatible with the QCPU.
Those special relays not compatible with the QCPU are converted to dummy special relays (SM1255) when changing programmable controller type. Search the dummy special relays (SM1255) and correct the programs as required.
-

7.4.2 Replacing the QnACPU with the QCPU

Basically, special relays for the QnACPU can be used without modification in the QCPU.*1

Note that, however, some of them are not compatible with the QCPU.

*1 When programs for the QnACPU are replaced with those for the Universal model QCPU by "Change PLC type", devices for the QnACPU, SM1000 to SM1255, and SD1000 to SD1255, are replaced with those for the QCPU.

7.5 Special Register Replacement

A special register is an internal register that has a set application in a programmable controller.

This section explains how to replace special registers when replacing the ACPU programs with QCPU programs.

For the contents of the relays and the handling of the special relays of the A/QnACPU and QCPU, refer to the QCPU User's Manual (Function explanations, Program fundamentals) and QCPU Programming Manual (Common Instructions).

7.5.1 Replacing the ACPU with the QCPU

The QCPU uses a different special register from the one for the ACPU.

With "Change PLC type", the automatic conversion is applied to the replacement of the ACPU special register (D9000 and after) with the QCPU special register (SD). (Refer to Section 7.1.2.)

Point

- 1) Some ACPU special registers are not compatible with the QCPU.
Those special registers not compatible with the QCPU are converted to dummy special registers (SD1255) when changing programmable controller type. Search the dummy special registers (SD1255) and correct the programs as required.
-

7.5.2 Replacing the QnACPU with the QCPU

Basically, special registers for the QnACPU can be used without modification in the QCPU.*¹

Note that, however, some of them are not compatible with the QCPU.

*1 When programs for the QnACPU are replaced with those for the Universal model QCPU by "Change PLC type", devices for the QnACPU, SM1000 to SM1255, and SD1000 to SD1255, are replaced with those for the QCPU.

7.6 Precautions for Replacing the MELSAP-II with the MELSAP3

The basic operation of the MELSAP3 is the same as the MELSAP-II , but the specifications are partially different.

This section provides the precautions for the replacement.

7.6.1 Starting SFC program

The SFC program can be started by using the special relay for starting/stopping the SFC program. That special replay for the ACPU (M9101) is replaced with the special relay for the QCPU (SM321) upon converting from the ACPU to QCPU. The specifications of the special relay differ between the two CPUs.

Specifications		Precautions for replacement
MELSAP-II (M9101)	MELSAP3 (SM321)	
Switches on and off with user operation.	SFC program starts up at default, since system is automatically turned on.	When starting/stopping the SFC program according to user conditions, turn the SM321 to on/off with program.

7.6.2 Block information (SFC information device)

The MELSAP-II and MELSAP3 have different method of executing the "Block START/STOP" and "Reading of the number of active steps and active step numbers" with block information (SFC information device).

	Specifications		Precautions for replacement
	MELSAP-II	MELSAP3	
Block START/STOP methods	<p>[START] Switching the block active bit on, executes forced start.</p> <p>[STOP] Switching the block clear bit on, stops the block also switching from on to off executes forced stop.</p>	<p>[START] Switching the block START/STOP bit on starts the concerned block forcibly.</p> <p>[STOP] Switching the block START/STOP bit off stops the concerned block forcibly.</p>	<p>[START] Adjusting program is not required when replacing the SFC program of the ACPU with the QCPU, since in that case, the "Block active bit" is replaced with the "Block START/STOP bit".</p> <p>[STOP] To stop the block forcibly, create a program to reset "Block START/STOP bit" of the corresponding block. Delete the program that switches the "Block clear bit" on/off since it is not required.</p>
The number of active steps and active step numbers reading	Reads the number of active steps in the corresponding block and active step numbers.	Reads only the number of active steps in the corresponding block.	To read the active step numbers, use the "Active step batch readout instructions (MOV, DMOV, BMOV)".

7.6.3 Specifications comparison between MELSAP-II and MELSAP3

When the SFC program (MELSAP-II) of the ACPU is reused as the SFC program (MELSAP3) of the QCPU, some specifications of the SFC program differ.

Select the QCPU that suits the contents and configuration of the existing SFC program (MELSAP-II).

Item	MELSAP-II		MELSAP3	
	ACPU	QnUCPU		
		Q00U(J)CPU, Q01UCPU, Q02UCPU	Q03UD(E)CPU, Q03UDVCPU, Q04UD(E)HCPU, Q04UDVCPU, Q06UD(E)HCPU, Q06UDVCPU, Q10UD(E)HCPU, Q13UD(E)HCPU, Q13UDVCPU	
Number of blocks	Max. 256 blocks	Max. 128 blocks	Max. 320 blocks	
Number of SFC steps	Max. 255 steps/block	Max. 128 steps/block	Max. 512 steps/block	
Step transition monitoring timer	Available (8 timers)	N/A	N/A	

7.6.4 Specifications comparison of MELSAP3 between QnACPU and QCPU

When the SFC program (MELSAP3) of the QnACPU is used as the SFC program of the QCPU, some specifications of the SFC program differ.

Select the QCPU that suits the contents and configuration of the existing SFC program (MELSAP3).

Item		MELSAP3		
		QnACPU	QnUCPU	
			Q00U(J)CPU, Q01UCPU, Q02UCPU	Q03UD(E)CPU, Q03UDVCPU, Q04UD(E)HCPU, Q04UDVCPU, Q06UD(E)HCPU, Q06UDVCPU, Q10UD(E)HCPU, Q13UD(E)HCPU, Q13UDVCPU
Number of blocks		Max. 320 blocks	Max. 128 blocks	Max. 320 blocks
Number of SFC steps		Max. 512 steps/block	Max. 128 steps/block	Max. 512 steps/block
Step transition monitoring timer		Available (10 timers)	N/A	N/A
SFC operation mode setting	Operation mode at double block START	Available	N/A (fixed to "Standby")	N/A (fixed to "Standby")
	Transition to active step (Operation mode at double step START)	Available	N/A (fixed to "Transition")	N/A (fixed to "Transition")
	Periodic execution block function	Available	N/A	N/A
SFC control instruction	Forced transition check instruction			
	LD and others TRn* ¹	Available	N/A	N/A
	LD and others BLm\TRn* ¹			
	Active step change instruction			
	SCHG (D)	Available	N/A	N/A
	Transition control instruction			
	SET TRn	Available	N/A	N/A
	SET BLm\TRn			
	RST TRn			
	RST BLm\TRn			
Block switching instruction				
BRSET (S)	Available	N/A	N/A	
SFC program for program execution management		Available	N/A	N/A
Setting for the execution type of program		Available	N/A	N/A

*1 Other than the LD instruction, there are the LD/AND/OR/LDI/, ANI, and ORI instructions.

7.6.5 SFC diagram that cannot be read normally in another format

SFC diagram created by SW□IVD-GPPA may cause an error such as incorrect reading.

Add dummy steps before replacement with SW□GPPA.

(Refer to "PRECAUTIONS FOR CREATING SFC PROGRAMS" in the GX Developer Version 8 Operating Manual (SFC).)

(Example)

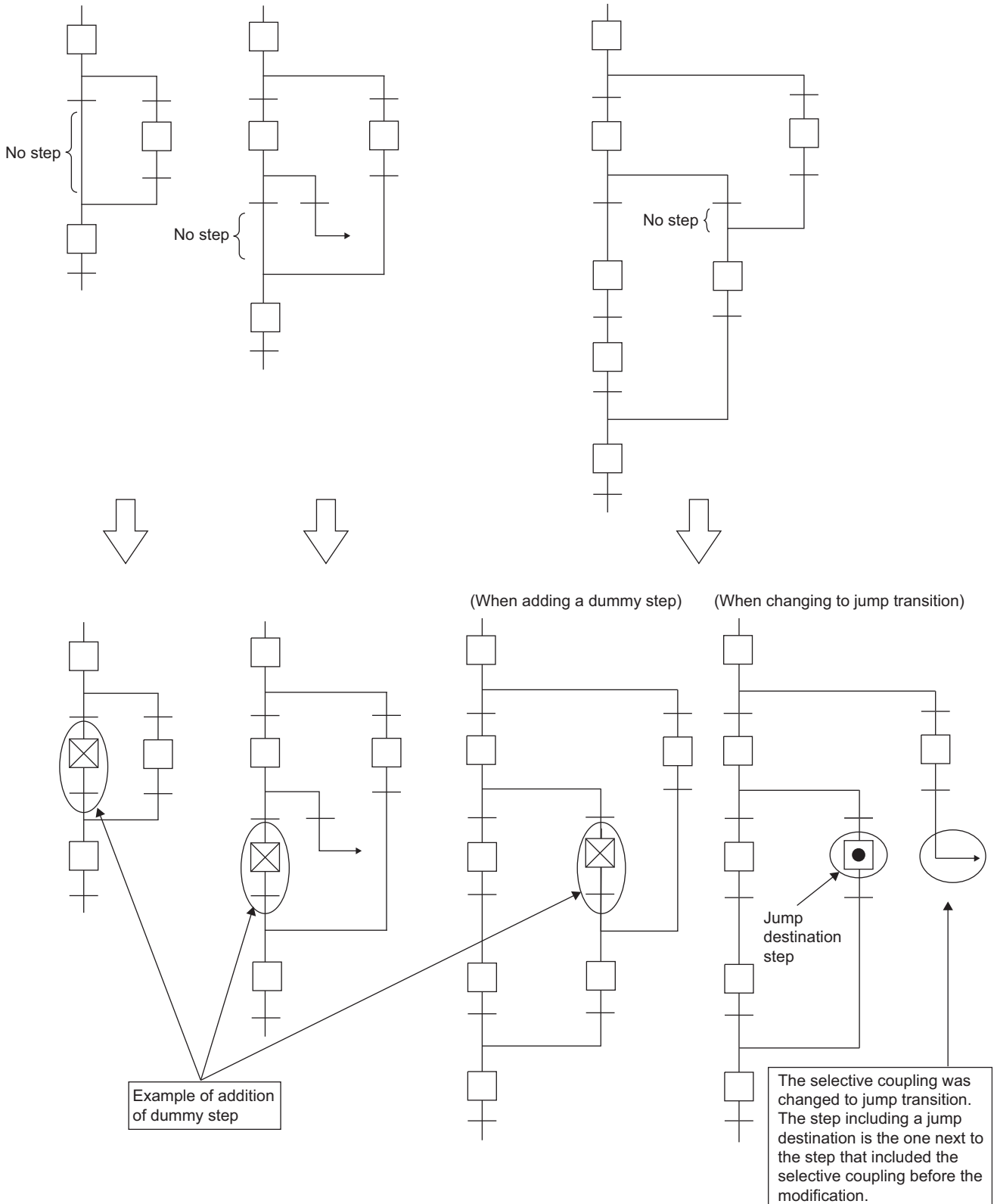

7.7 Precautions for Program Replacement

7.7.1 List of applicable devices

Device name		QCPU		
Number of I/O points*7		Q03UDVCPU, Q04UDVCPU, Q06UDVCPU, Q13UDVCPU } 4096	Q00UJCPU: 256 points Q00UCPU: 1024 points Q01UCPU: 1024 points	Q02UCPU: Q03UD(E)CPU, Q04UD(E)HCPU, Q06UD(E)HCPU, Q10UD(E)HCPU, Q13UD(E)HCPU } 4096 points 2048 points
Number of I/O device points*6		8192 points		
Internal relay		Q03UDV: 9216 points Q04/06UDV: 15360 points Q13UDV: 28672 points	8192 points*1	
Latch relay		8192 points*1		
Step relay	Sequence program	-		
	SFC	8192 points		
Annunciator		2048 points*1		
Edge relay		2048 points*2		
Link relay		8192 points*1		
Special relays for link		2048 points		
Timer		2048 points*1		
Retentive timer		0 point*1		
Counter		1024 points*1		
Data register		12288 points*1		
Link register		Q03UDV: 13312 points Q04/06UDV: 22528 points Q13UDV: 41984 points	8192 points*1	
Link special register		2048 points		
Function inputs		16 points (FX0 to FXF)*5		
Function outputs		16 points (FY0 to FYF)*5		
Function registers		5 points (FD0 to FD4)		
Special relay		2048 points		
Special register		2048 points		
Link direct device		Exclusive to CC-LinkIE and MELSECNET/H J□□\X□□, J□□\Y□□, J□□\W□□, J□□\B□□, J□□\S□□, J□□\SB□□		
Intelligent function module device		Specified from U□□\G□□		
Index register	Z	20 points (Z0 to Z19)		
	V*2	-		
File register		32768 points/block*4*8 (R0 to R32767)		
Accumulator*3		-		
Nesting		15 points		
Pointer		4096 points	512 points	4096 points
Interrupt pointer		256 points	128 points	256 points
Number of SFC blocks		320 points	128 points	320 points
Number of SFC steps		Max. 512 points/block	Max. 128 points/block	Max. 512 points/block
Decimal constant		K-2147483648 to K2147483647		
Hexadecimal constant		H0 to HFFFFFFF		
Real constant*6		E±1.17550-38 to E±3.40282+38		
Character string		"QnACPU", "ABCD"*4		

	QnACPU	AnUCPU	AnACPU	AnNCPU
	Q2ACPU: 512 points Q2ACPU-S1: 1024 points Q3ACPU: 2048 points Q4ACPU: 4096 points	A2UCPU: 512 points A2UCPU-S1: 1024 points A3UCPU: 2048 points A4UCPU: 4096 points	A2ACPU: 512 points A2ACPU-S1: 1024 points A3ACPU: 2048 points	A1NCPU: 256 points A2NCPU: 512 points A2NCPU-S1: 1024 points A3NCPU: 2048 points
	8192 points	8192 points	Same I/O device points of applicable CPU module	
	8192 points ^{*1}	Total 8192 points		Total 2048 points
	8192 points			—
	—			—
	8192 points	—		
	2048 points ^{*1}	2048 points		256 points
	2048 points ^{*2}	—		
	8192 points ^{*1}	8192 points	4096 points	1024 points
	2048 points	56 points		
	2048 points ^{*1}	Total 2048 points		Total 256 points
	0 point ^{*1}			
	1024 points ^{*1}	1024 points		256 points
	12288 points ^{*1}	8192 points	6144 points	1024 points
	8192 points ^{*1}	8192 points	4096 points	1024 points
	2048 points	56 points		
	16 points (FX0 to FXF) ^{*5}	—		
	16 points (FY0 to FYF) ^{*5}	—		
	5 points (FD0 to FD4)	—		
	2048 points	256 points		
	2048 points	256 points		
	Specified from J□□\G□□	—		
	Specified from U□□\G□□	—		
	16 points (Z0 to Z15)	7 points (Z, Z1 to Z6)		1 point (Z)
	—	7 points (V, V1 to V6)		1 point (V)
	32768 points/block (R0 to R32767)	8192 points/block (R0 to R8191)		
	—	2 points		
	15 points	8 points		
	4096 points	256 points		
	48 points	32 points		
	320 points	—		
	Max. 512 points/block	—		
	K-2147483648 to K2147483647			
	H0 to HFFFFFFF			
	E±1.17550-38 to E±3.40282+38	—		
	"QnACPU", "ABCD"	—		

- *1 The number of points for use can be changed with parameters.
- *2 "V" is used for edge relays for the QCPU/QnACPU.
- *3 The format of instructions that use the accumulator for the AnNCPU/AnACPU/AnUCPU is changed for the Q/QnACPU.
- *4 The Q00UJCPU does not have file registers.
- *5 Each 5 points of FX0 to FX4 and FY0 to FY4 can be used on the programs.
- *6 The number of points that can be used on the programs.
- *7 The number of accessible points to actual I/O modules.
- *8 For the Universal model QCPU, set the total number of points: file registers, extended data registers, and extended link registers.

Point

There are devices and constants that are not shown in the list of applicable devices. For details, refer to the QnUCPU User's Manual (Function Explanation, Program Fundamentals).

7.7.2 I/O control method

○ : Usable, – : Unusable

I/O control method		QnUCPU	QnACPU	AnUCPU	AnACPU	AnNCPU
Refresh mode		○	○	○	○	○ ^{*2}
Direct I/O method	Partial refresh instructions	○	○	○	○	○
	Dedicated instructions ^{*1}	–	–	○	○	–
	Direct access input	○	○	–	–	–
	Direct access output	○	○	–	–	–
Direct mode		–	–	–	–	○ ^{*2}

*1 The direct output dedicated instructions include the DOUT, DSET and SRST instruction and do not include the direct input dedicated instructions.

*2 The DIP switch on the AnNCPU enables to switch between refresh mode and direct mode.

7.7.3 Usable data format for instructions

○ : Usable, △ : Usable with conditions, – : Unusable

Setting data		QnUCPU	QnACPU	AnUCPU	AnACPU	AnNCPU
Bit data	Bit device	○		○	○	○
	Word device	○ (Bit designation required)		–	–	–
Word data	Bit device	○ (Digit designation required)		○ (Digit designation required)	○ (Digit designation required)	○ (Digit designation required)
	Word device	○		○	○	○
Double-word data	Bit device	○ (Digit designation required)		○ (Digit designation required)	○ (Digit designation required)	○ (Digit designation required)
	Word device	○		○	○	○
Real number data		○		△ ^{*2}	△ ^{*2}	△ ^{*1}
Character string data		○		△ ^{*2}	△ ^{*2}	△ ^{*1}

*1 The microcomputer package for the floating point real number type of the SW0SRXV-FN2UP package can be used during entry.

*2 The AnA/AnU-dedicated instruction can be used.

7.7.4 Timer

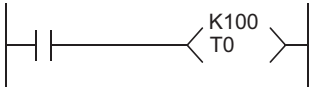
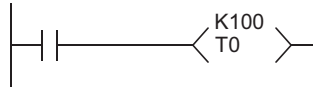
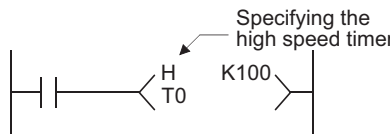
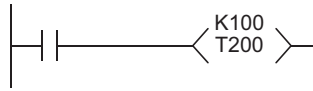
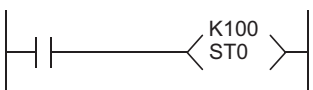
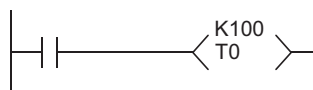
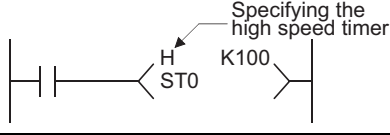
Function		QCPU/QnACPU	AnUCPU	AnACPU	AnNCPU
Low-speed timer	Measurement unit	<ul style="list-style-type: none"> • 100ms (Default) Changeable in the range of 1 to 1000ms (Parameter) (QnACPU: 10 to 1000ms) 	<ul style="list-style-type: none"> • Fixed to 100ms 		
	Specifying method				
High-speed timer	Measurement unit	<ul style="list-style-type: none"> • 10ms (Default) Changeable in the range of 0.1 to 100ms (parameter) (QnACPU: 1 to 100ms) 	<ul style="list-style-type: none"> • Fixed to 10ms 		
	Specifying method				
Retentive timer	Measurement unit	<ul style="list-style-type: none"> • The same measurement unit as low-speed timer 	<ul style="list-style-type: none"> • Fixed to 100ms 		
	Specifying method				
High-speed retentive timer	Measurement unit	<ul style="list-style-type: none"> • The same measurement unit as high-speed timer 	<ul style="list-style-type: none"> • None 		
	Specifying method				
Setting range for set value		• 1 to 32767	• 1 to 32767		
Processing the set value 0		• Instant-ON	• Infinite (No time up)		
Updating present value		• When executing the OUT Tn instruction	• When executing the END processing		
ON/OFF processing for contact					

(1) Precautions for using timer

The following describes the precautions for using a timer. For details, refer to the QnUCPU User's Manual (Function Explanation, Program Fundamentals).

(a) QnUCPU/QnACPU timer ladder programming method

Set the number of points for the timer and retentive timer in the Device setting of the parameter setting.

To use the low-speed timer, high-speed timer, retentive timer and high-speed retentive timer separately, add "H" or "S" to the OUT instruction in programming.

Ex.) Low-speed timer: OUT T0 Kn

High-speed timer: OUTH T0 Kn

Low-speed retentive timer: OUT ST0 Kn

High-speed retentive timer: OUTH ST0 Kn

(b) ACPU timer ladder programming method

Set the total number of points of timer, and the first device number of low-speed timer, high-speed timer and retentive timer in the Device setting of the parameter setting.

The default setting is as follows:

Number of points of timer: 256

First device number of low-speed timer: 0 (T0 to T199)

First device number of high-speed timer: 200 (T200 to T255)

First device number of retentive timer: 0

When using the retentive timer, change the setting to reserve necessary number of points.

7.7.5 Counter

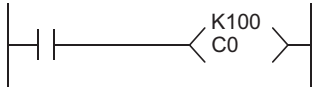
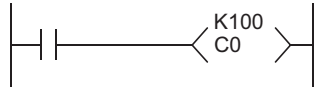
Function	QnUCPU/QnACPU	AnUCPU	AnACPU	AnNCPU
Specifying method				
Updating present value				
ON/OFF processing for contact	• When executing the OUT Cn instruction	• When executing the END instruction		

7.7.6 Display instructions

Instruction	QnUCPU	QCPU/QnACPU	AnUCPU	AnACPU	AnNCPU
PR	Not applicable for the Universal model QCPU.	<ul style="list-style-type: none"> • With SM701 OFF: Outputs characters before 00H. • With SM701 ON: Outputs 16 characters. 	<ul style="list-style-type: none"> • With M9049 OFF: Outputs characters before 00H. • With M9049 ON: Outputs 16 characters. 		
PRC	Consider replacing with a display unit or touch panel.	<ul style="list-style-type: none"> • With SM701 OFF: Outputs comments in 32 characters. • With SM701 ON: Outputs first 16 characters of comment. 	<ul style="list-style-type: none"> • Outputs comment in 16 characters. 		

7.7.7 Index register

(1) Replacing index register

"Z, Z1 to Z6, V, V1 to V6" and "Z0 to Z15" are used as index register for the A series and Q series, respectively. Therefore, their specifications differ.

"V" is used as edge relay for the Q series. The device is used to memorize the PLS/PLF information to contacts from the start of the ladder block.

The following table shows replacement of index register when A series program was utilized to the Q series with "Change PLC type".

A series	Q series
Z	Z0
Z1 to Z6	Z1 to Z6
V	Z7
V1 to V6	Z8 to Z13

☒ Point

When modifying contact instructions of timer/counter with indexes, AnA/AnUCPU has no restrictions on index registers.

For QCPU, only "Z0,Z1" can be specified for index registers when modifying contact instructions of timer/counter with indexes according to its specification.

When using index registers other than "Z0,Z1" in the existing AnA/AnUCPU, it is replaced with "SM1255" as unconvertible instruction. Therefore, correcting/changing program is required.

(2) Index register 32-bit specification

When using index register as 32-bit instruction in the A series, Z and V that has the same number with Z are processed as low-order 16-bit value and high-order 16-bit value, respectively.

However, the Q series processes Zn and Zn + 1 as low-order 16 bits and high-order 16 bits, respectively.

If a program to which "Change PLC type" is performed includes index register with 32-bit specification, reviewing the index register after "Change PLC type" is necessary.

The following shows an example using an instruction whose operation result will be in 32 bits.

Instruction	A series	Q series
DMOV D0 Z1	V1, Z1 (High order) (Low order)	Z2, Z1 (High order) (Low order)
/ D0 D1 Z1	Z1(Quotient) V1(Remainder)	Z1(Quotient) Z2(Remainder)

When utilizing the A series program to the Q series with "Change PLC type", the operation result may be stored to the index register having different number as intended one.

(Example)

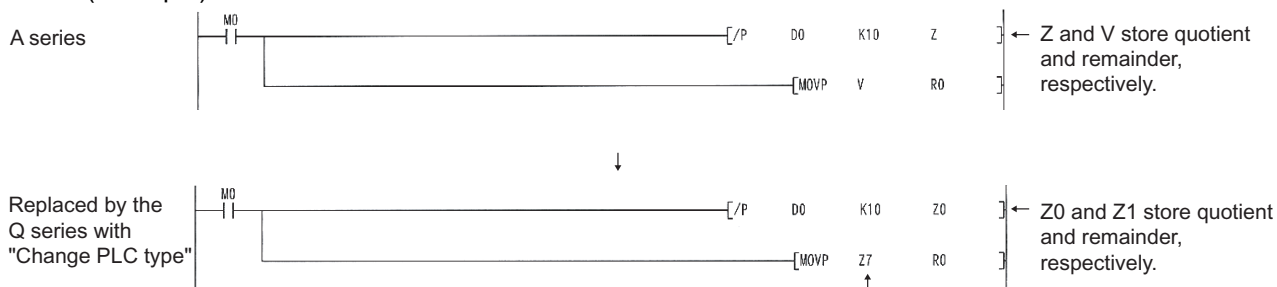

Device replaced with "Change PLC type".
Modify this to Z1.

7.7.8 Instructions where format is changed (Excluding AnACPU/AnUCPU dedicated instructions)

Instructions using the accumulator for the AnUCPU, AnACPU, and AnNCPU are changed in their format, since the QnUCPU/QnACPU do not have the accumulator (A0, A1).

The accumulator A0 is converted to SD718, the accumulator A1 is converted to SD719.

Function	QCPU/QnACPU		AnUCPU/AnACPU/AnNCPU	
	Format of instructions	Remarks	Format of instructions	Remarks
Right rotation of 16-bit data	$\text{ROR } D \ n$	• D: Rotation data	$\text{ROR } n$	• Rotation data is set in A0.
	$\text{RCR } D \ n$	• D: Rotation data • Use SM700 for carry flag	$\text{RCR } n$	• Rotation data is set in A0. • Use M9012 for carry flag.
Left rotation of 16-bit data	$\text{ROL } D \ n$	• D: Rotation data	$\text{ROL } n$	• Rotation data is set in A0.
	$\text{RCL } D \ n$	• D: Rotation data • Use SM700 for carry flag	$\text{RCL } n$	• Rotation data is set in A0. • Use M9012 for carry flag.
Right rotation of 32-bit data	$\text{DROR } D \ n$	• D: Rotation data	$\text{DROR } n$	• Rotation data is set in A0, A1.
	$\text{DRCR } D \ n$	• D: Rotation data • Use SM700 for carry flag	$\text{DRCR } n$	• Rotation data is set in A0, A1. • Use M9012 for carry flag.
Left rotation of 32-bit data	$\text{DROL } D \ n$	• D: Rotation data	$\text{DROL } n$	• Rotation data is set in A0, A1.
	$\text{DRCL } D \ n$	• D: Rotation data • Use SM700 for carry flag	$\text{DRCL } n$	• Rotation data is set in A0, A1. • Use M9012 for carry flag.
16-bit data search	$\text{SER } S1 \ S2 \ D \ n$	• Search result is stored in D, D + 1 device	$\text{SER } S1 \ S2 \ n$	• Search result is stored in A0, A1.
32-bit data search	$\text{DSER } S1 \ S2 \ D \ n$	• Search result is stored in D, D + 1 device	$\text{DSER } S1 \ S2 \ n$	• Search result is stored in A0, A1.
16-bit data checks	$\text{SUM } S \ D$	• Check result is stored in D device	$\text{SUM } S$	• Check result is stored in A0.
32-bit data checks	$\text{DSUM } S \ D$	• Check result is stored in D device	$\text{DSUM } S$	• Check result is stored in A0.
Partial refresh	$\text{RFS } D \ n$	• Add dedicated instruction	$\text{SEG } D \ n$	• Only when M9052 is on.*2
8-characters ASCII conversion	$\text{\$MOV } (\text{Character strings}) \ D$		$\text{ASC } (\text{Character strings}) \ D$	*2
Carry flag set	$\text{SET } \text{SM700}$	• No dedicated instruction	STC	*2

Function	QCPU/QnACPU		AnUCPU/AnACPU/AnNCPU	
	Format of instructions	Remarks	Format of instructions	Remarks
Carry flag reset		• No dedicated instruction		*2
Jump to END instruction		• Add dedicated instruction		• P255: END instruction specification*2

*1 Deleting or adjusting is required, since it becomes the instruction of different function.

*2 Converted to "SM1255" as unconvertible instruction.

7.7.9 AnACPU/AnUCPU dedicated instruction

(1) Display method of dedicated instruction

The dedicated instructions for the AnACPU/AnUCPU using LEDA, LEDB, LEDC, SUB, and LEDR instructions are changed into instructions in the same format as basic instructions and application instructions for the QnUCPU/QnACPU.

Some instructions are not converted since the QnUCPU/QnACPU does not have the corresponding instruction. The instructions are converted into OUT SM1255.

Replace or delete instructions that have been converted to OUT SM1255.

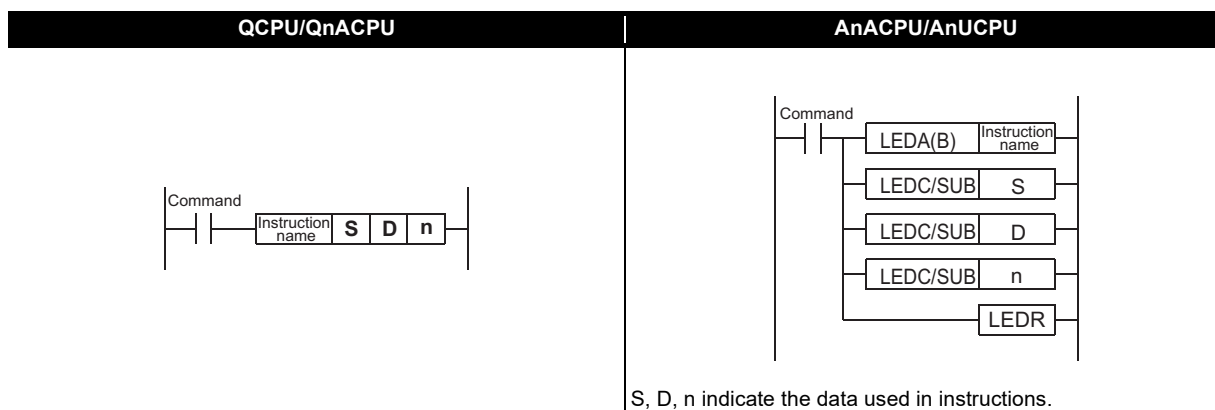

(2) Dedicated instruction with changed instruction name

For the AnACPU/AnUCPU, some instruction names are the same as the basic instructions/application instructions. Those names have been changed for the QnUCPU/QnACPU.

Function	QCPU/QnACPU	AnACPU/AnUCPU
Floating decimal point addition	E+	ADD
Floating decimal point subtraction	E-	SUB
Floating decimal point multiplication	E*	MUL
Floating decimal point division	E/	DIV
Data dissociation	NDIS	DIS
Data linking	NUNI	UNI

7.7.10 Setting method when multiple sequence programs are created

For the ACPU, some programs include main program and subprogram, and main programs have SFC programs. When replacing those programs with the QCPU, they are separated into different programs. For the separated programs in the QCPU, the Program setting of the parameter setting is required. This section provides precautions after replacement of program settings, etc.

(1) Program files at replacement

(a) When the main program and subprogram are operated as one program in CPU

Register in the order of MAIN, SUB1, SUB2 in the Program setting of the PLC parameter of GX Developer, and set all the execution types to "Scan".

Default upon the registration is "Scan".

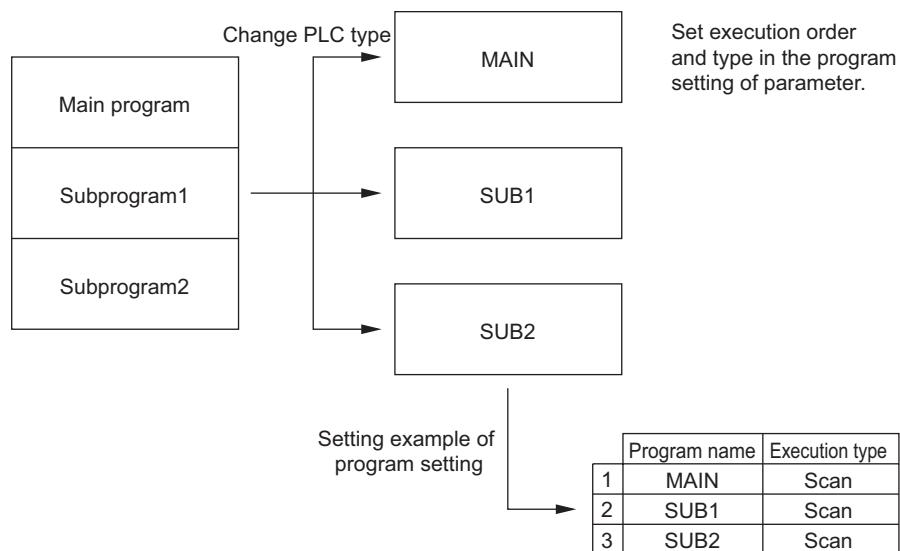

(b) When ACPU has interrupt program

For the ACPU, the main program and subprogram have the same interrupt program.

For the QCPU, delete interrupt programs except one of them, since the QCPU can assign one interrupt pointer per program.

When programs of the same interrupt pointer exist, CPU will result in error when interrupt condition is satisfied.

Register in order of MAIN, SUB1 in the PLC parameter program setting of the GX Developer, and set all execution type to "Scan".

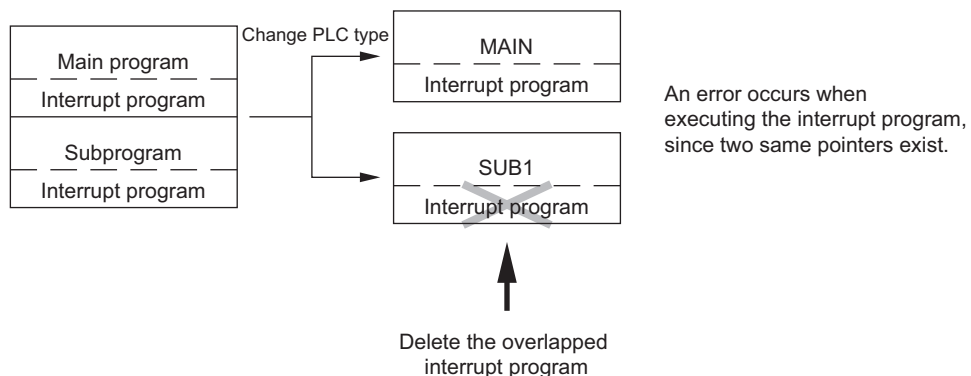

(c) When main program contains SFC program

For the ACPU, the SFC program operates as the microcomputer program of main program. Since the QCPU deals the SFC program as one program, the SFC program is converted to "MAIN-SFC". Accordingly, two separate programs are created when the ACPU is converted; "MAIN", converted from main program, and "MAIN-SFC". Register in the order of MAIN, MAIN-SFC in the Program setting of the parameter setting of GX Developer, and set all execution types to "Scan". Refer to Section 7.6 for precautions of replacing from the ACPU SFC (MELSAP-II) to the QCPU (MELSAP3).

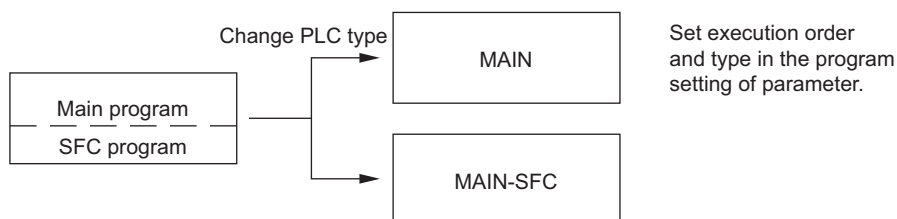

(2) Program setting of the GX Developer

The following explains required program settings for executing multiple programs. The execution type of program is set in Program setting of the PLC parameter setting of the GX Developer. A CPU module executes the programs of the specified execution type in the setting order.

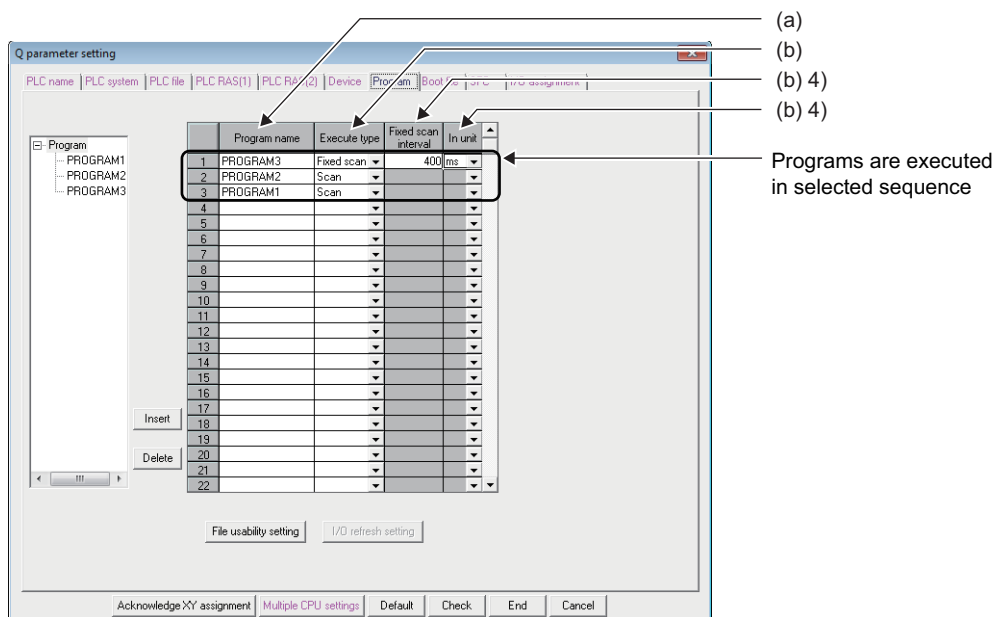

(a) Program name

Set a name for a program to be executed with a CPU module.

(b) Execution type

Select the execution type of files set in the program name.

1) Initial execution type (Initial)

This type of programs is executed only one time, when switching the power supply from off to on or STOP status to RUN status.

2) Scan execution type (Scan)

This type of programs is executed every scan, after having executed the initial execution type program.

3) Stand-by type (Wait)

This type of program is executed only when demanded.

4) Fixed scan execution type (Fixed scan)

This type of program is executed per interval set in the "Fixed scan interval" and "In unit".

- Fixed scan interval

Sets the program execution interval of fixed execution type program.

Setting range depends on the unit set in the fixed scan interval.

- For "ms": 0.5 to 999.5ms (0.5ms unit)

- For "s": 1 to 60s (1s unit)

- Unit

Selects the unit ("ms" or "s") for the fixed scan interval.

7.7.11 Precautions for file register replacement

This section provides precautions for replacing the ACPU or QnACPU using file registers with the QCPU.

	ACPU	QnACPU	QCPU
Storage destination	Memory cassette	Memory card (Up to 2 cards, 4 drives)	<ul style="list-style-type: none"> Standard RAM Memory card (1 card)*1
Maximum number of points	Depends on applicable memory cassette used	1018k points × 2 (When using two 2M memory cards)	Standard RAM: Up to 512k points*2 (Depending on CPU model) + 4086k points (When using an 8M memory card)
Number of points for 1 block	8k points	32k points	32k points

*1 The Universal model high-speed type QCPU does not allow a file register to be stored in an SD memory card.

*2 The Universal model high-speed type QCPU is capable of storing a maximum of 4608K points when an 8M extended SRAM cassette is used.

(1) Changing storage destination after replacement

(a) Changing storage destination after replacement of the ACPU

The value whose capacity has been set with the parameter of ACPU is not converted, since the storage destination is different.

Set the storage destination and capacity (points) in the file setting of the PLC parameter setting. Be sure to select "Use the following file" when setting the storage destination.

Selecting "Use the following file" makes the file equivalent to the ACPU.

(b) Changing storage destination after replacement of the QnACPU

Drive No. for storing file registers differs between the QnACPU and QCPU.

Set the parameters (Standard RAM, memory card (RAM)*3, memory card (ROM)*3) according to the drive where the file register is stored.

*3 The Universal model high-speed type QCPU does not allow the use of a memory card (RAM) and a memory card (ROM).

(2) Maximum number of points

(a) Maximum number of points after replacement of the ACPU

For the ACPU with the memory cassette A4UMCA-128, the memory capacity is 1MB.

When replacing the ACPU with the QCPU, installing the SRAM card of 1MB or more secures the file register capacity of the ACPU.

(b) Maximum number of points after replacement of the QnACPU

When two memory cards have been installed and files have been switched in using, the maximum number of points may not be secured after replacing the QnACPU with the QCPU.

(3) Number of points for one block

(a) Number of points for one block after replacement of the ACPU

For the ACPU with the extension file registers, the number of points for one block is 8k points.

For the QCPU, the number of points for one block is 32k points.

(b) Number of points for one block after replacement of the QnACPU

Definition of file register capacity is the same for the QnACPU and QCPU.

When the storage destination and maximum number of points are the same, program adjustment for file registers is not required.

7.7.12 Boot run method (Writing programs to ROM)

The ROM operation of the ACPU corresponds to the boot run of the QCPU. The overview of the boot run is explained below.

For details, refer to QnUCPU User's Manual (Function Explanation, Program Fundamentals).

The program memory of the Universal model QCPU is a flash ROM, and so boot run is not necessary. (If a battery error occurs, the written files are not deleted.)

However, the Universal model QCPU other than the Q00UJCPU, Q00UCPU, and Q01UCPU allows boot run from a memory card or an SD memory card.

Here are the steps for boot run from a memory card:

Step 1: Setting up the boot file settings

Set the names and storage destinations of the files to be booted to the program memory in the Boot file tab of the PLC parameter dialog box of GX Works2.

Step 2: Installing a memory card

Install a memory card or an SD memory card into the CPU module.

Step 3: Writing to the memory card

Write the parameters and programs set in the Boot file tab to the memory card or SD memory card using GX Works2.

Step 4: Executing the program

Perform a reset with the RUN/STOP/RESET switch.

Upon completion of booting from the specified memory, the operation starts with the BOOT LED lighting up.

APPENDICES

Appendix 1 External Dimensions

For external dimensions of modules shown in this handbook, refer to the user's manual for each module.

Appendix 2 Spare Parts Storage

- (1) **The general specifications of programmable controllers are as follows. Please do not store spare parts under a high temperature or high humidity condition, even within the range guaranteed by the specifications.**

Storage ambient temperature	-20 to 75 °C
Storage ambient humidity	10 to 90%, no condensation

- (2) **Store in a place avoiding direct sunlight.**
- (3) **Store under a condition with no dust or corrosive gas.**
- (4) **The battery capacity of a A6BAT battery or a lithium-coin battery (commercially available) for memory card will be decreased by its self-discharging even when it is not used. Replace it with new one in 5 years as a guideline.**
- (5) **For a power supply module, CPU module with built-in power supply, or analog module that uses any aluminum electrolytic capacitor, which is indicated in the table below, take the following measures since the characteristics will be deteriorated when the aluminum electrolytic capacitor is left un-energized for a long time.**

Product	Model
CPU module (Power supply built-in type)	A1NCPUP, A1NCPUP21, A1NCPUR21, A1NCPUP21-S3, A2CCPU, A2CCPUP21, A2CCPUR21, A2CCPUC24, A2CCPUC24-PRF, A2CJCPU-S3
Power supply module	A61P, A61PEU, A61P-UL, A62P, A62PEU, A63P, A68P, A61RP, A67RP, A2CJ66P
Analog module	A62DA, A62DA-S1

[Countermeasures for preventing aluminum electrolytic capacitor characteristics deterioration]

Apply the rated voltage to the aluminum electrolytic capacitor for several hours to activate it. Or, rotate products at the periodic inspection (in every 1 to 2 years).

[Reference]

The life of an aluminum electrolytic capacitor, even if not used, under a normal temperature decreases approximately at 1/4 speed of the case when it is energized.

Appendix 3 Related Manuals

Appendix 3.1 Materials for replacement

(1) Renewal catalogue

No.	Manual Name	Manual Number
1	MELSEC-A/QnA Series Transition Guide	L08077E
2	MELSEC-AnS/QnAS (Small Type) Series Transition Guide	L08236E

(2) Handbook for transition

No.	Manual Name	Manual Number
1	Transition from MELSEC-A/QnA (Large Type) Series to Q Series Handbook (Fundamentals)	L08043ENG
2	Transition from MELSEC-A/QnA (Large Type) Series to Q Series Handbook (Intelligent Function Modules)	L08046ENG
3	Transition from MELSEC-A/QnA (Large Type) Series to Q Series Handbook (Network Modules)	L08048ENG
4	Transition from MELSEC-A/QnA (Large Type) Series to Q Series Handbook (Communications)	L08050ENG
5	Transition from MELSEC-A0J2H Series to Q Series Handbook	L08060ENG
6	Transition from MELSECNET/MINI-S3, A2C(I/O) to CC-Link Handbook	L08061ENG
7	Transition from MELSEC-I/O LINK to CC-Link/LT Handbook	L08062ENG
8	Transition from MELSEC-I/OLINK to AnyWire DB A20 Handbook	L08263ENG
9	Transition of CPUs in MELSEC Redundant System Handbook (Transition from Q4ARCPU to QnPRHCPU)	L08117ENG

(3) Renewal examples

No.	Manual Name	Manual Number
1	MELSEC-A/QnA (Large), AnS/QnAS (Small) Transition Examples	L08121E

(4) Others

No.	Manual Name (TECHNICAL BULLETIN)	Manual Number
1	Procedures for Replacing Positioning Module AD71 with QD75	FA-A-0060
2	Precautions for replacing A/QnA (large type) series CPU with Universal model QCPU	FA-A-0068

Appendix 3.2 A/QnA series

No.	Manual Name	Manual Number
1	MELSEC-A/QnA Data Book	L08029E
2	Type A1N/A2N (S1) / A3NCPU User's Manual	IB-66543
3	Type A2A (S1) / A3ACPU User's Manual	IB-66544
4	Type A2U (S1) / A3U/A4UCPU User's Manual	IB-66436
5	Q2A CPU (S1) / Q3ACPU/Q4ACPU User's Manual	IB-66608
6	QCPU User's Manual (Hardware Design, Maintenance and Inspection)	SH-080483ENG
7	QCPU User's Manual (Function Explanation, Program Fundamentals)	SH-080484ENG
8	Type A2CCPU (P21/R21) , A2CCPU-DC24V, A2CCPUC24 (-PRF) , A2CJCPU User's Manual	IB-66545
9	Type ACPU/QCPU-A (A Mode) (Fundamentals) Programming Manual	IB-66249
10	Type ACPU/QCPU-A (A Mode) (Common Instructions) Programming Manual	IB-66250
11	Type AnSHCPU/AnACPU/AnUCPU/QCPU-A (A Mode) Programming Manual (Dedicated Instructions)	IB-66251
12	Type AnACPU/AnUCPU/QCPU-A (A mode) Programming Manual (PID Control Instructions)	IB-66258
13	Type MELSAP-II(SFC) Programming Manual	IB-66361
14	QnACPU Programming Manual (Fundamentals)	IB-66614
15	QnACPU Programming Manual (Special Function Module)	SH-4013
16	QCPU(Q Mode)/QnACPU Programming Manual (Common Instructions)	SH-080039
17	QCPU(Q Mode)/QnACPU Programming Manual (PID Control Instructions)	SH-080040
18	QCPU(Q Mode)/QnACPU Programming Manual (SFC)	SH-080041
19	QA65B/QA68B Extension Base Unit User's Manual	IB-0800158
20	A-A1S Module Conversion Adapter User's Manual	IB-0800352
21	QA6ADP QA Conversion Adapter Module User's Manual	IB-0800402
22	I/O module type Building block User's Manual	IB-66140
23	A/D converter module type A68AD User's Manual	IB-66054
24	A/D converter module type A68AD-S2 User's Manual	IB-66213
25	Analog-Digital Converter Module type A68ADN User's Manual	IB-66307
26	Analog-Digital Converter Module type A616AD User's Manual	IB-66171
27	D/A converter module type A62DA User's Manual	IB-66053
28	D/A converter module type A62DA-S1 User's Manual	IB-66177
29	Digital-Analog Converter Module type A68DAV/DAI(S1) User's Manual	IB-66285
30	Digital-Analog Converter Module type A616DAV User's Manual	IB-66172
31	Digital-Analog Converter Module type A616DAI User's Manual	IB-66173
32	Pt100 input module type A68RD3/4 User's Manual	IB-66308
33	Type A68RD3N/4N, A1S62RD3N/4N Pt100 Input Module User's Manual	SH-080193
34	Temperature-Digital Converter Module type A616TD User's Manual	IB-66174
35	High speed counter module type AD61-S1 User's Manual	IB-66052
36	Positioning module type AD70 User's Manual	IB-66309
37	Positioning Module Type AD72 User's Manual	IB-66095
38	A1SD75P1-S3/P2-S3/P3-S3,AD75P1-S3/P2-S3/P3-S3 Positioning Module User's Manual	IB-66716
39	Positioning module type A1SD75M/M2/M3, AD75M1/M2/M3 User's Manual	IB-66715
40	Type MELSECNET, MELSECNET/B Data Link System Reference Manual	IB-66350
41	Control & Communication Link System Master/Local Module Type AJ61BT11/ A1SJ61BT11 User's Manual	IB-66721
42	For A Ethernet Interface Module User's Manual	SH-080192
43	For QnA Ethernet Interface Module User's Manual	SH-080146
44	Computer Link Module (Com.link func./Print. func.) User's Manual	SH-3511
45	Serial Communications Module User's Manual (Modem Function Additional Version)	IB-66612

No.	Manual Name	Manual Number
46	Intelligent Communication Module type AD51-S3 User's Manual	IB-66189
47	Intelligent communication module type AD51H-S3 User's Manual	IB-66401
48	MELSECNET/MINI-S3 Master Module Type AJ71PT32-S3, AJ71T32-S3, A1SJ71PT32-S3, A1SJ71T32-S3 User's Manual	IB-66565
49	MELSEC-I/O Link Remote I/O System Master Module type AJ51T64/A1SJ51T64 User's Manual	IB-66574
50	MELSECNET, MELSECNET/B Local Station Data Link Module User's Manual	SH-080670ENG
51	Type MELSECNET/10 Network system (PLC to PLC network) Reference Manual	IB-66440
52	For QnA/Q4AR MELSECNET/10 Network System Reference Manual	IB-66690
53	Control & Communication Link System Master/Local Module type AJ61QBT11/A1SJ61QBT11 User's Manual	IB-66722
54	Positioning Module Type AD71(S1/S2/S7)/A1SD71-S2(S7) User's Manual	IB-66563
55	PC fault detection module type AS91, A1SS91, A0J2-S91 User's Manual	IB-66626

Appendix 3.3 Q series

No.	Manual Name	Manual Number
1	MELSEC-Q series [QnU]	L08101
2	QCPU User's Manual (Hardware Design, Maintenance and Inspection)	SH-080483ENG
3	QnUCPU User's Manual (Function Explanation, Program Fundamentals)	SH-080807ENG
4	Qn(H)/QnPH/QnPRHCPU User's Manual (Function Explanation, Program Fundamentals)	SH-080808ENG
5	MELSEC-Q/L Programming Manual (Common Instruction)	SH-080809ENG
6	MELSEC-Q/L/QnA Programming Manual (PID Control Instructions)	SH-080040
7	QCPU(Q Mode)/QnACPU Programming Manual (SFC)	SH-080041
8	QA65B/QA68B Extension Base Unit User's Manual	IB-0800158
9	I/O Module Type Building Block User's Manual	SH-080042
10	Spring Clamp Terminal Block Model Q6TE-18S User's Manual	IB-0800204
11	Insulation Displacement Connector for MELSEC-Q Series 32-Point I/O Module User's Manual	IB-0800228
12	Analog-Digital Converter Module User's Manual Q64AD/Q68ADV/Q68ADI/GX Configurator-AD(SW2D5C-QADU-E)	SH-080055
13	Channel Isolated High Resolution Analog-Digital Converter Module / Channel Isolated High Resolution Analog-Digital Converter Module (With Signal Conditioning Function) User's Manual	SH-080277
14	Channel Isolated Analog-Digital Converter Module/Channel Isolated Analog-Digital Converter Module (With Signal Conditioning Function) User's Manual Q68AD-G/Q66AD-DG/GX Configurator-AD(SW2D5C-QADU-E)	SH-080647ENG
15	Digital-Analog Converter Module User's Manual Q62DAN/Q64DAN/Q68DAVN/Q68DAIN/Q62DA/Q64DA/Q68DAV/Q68DAI/GX Configurator-DA(SW2D5C-QDAU-E)	SH-080054
16	Channel Isolated Digital-Analog Converter Module User's Manual Q62DA-FG/GX Configurator-DA(SW2D5C-QDAU-E)	SH-080281E
17	Channel Isolated Digital-Analog Converter Module User's Manual Q66DA-G/GX Configurator-DA(SW2D5C-QDAU-E)	SH-080648ENG
18	Analog Input/Output Module User's Manual Q64AD2DA/GX Configurator-AD(SW2D5C-QADU-E)/GX Configurator-DA(SW2D5C-QDAU-E)	SH-080793ENG
19	RTD Input Module Channel Isolated RTD Input Module User's Manual Q64RD/Q64RD-G/GX Configurator-TI (SW1D5C-QTIU-E)	SH-080142
20	Channel Isolated RTD Input Module User's Manual Q68RD3-G/GX Configurator-TI (SW1D5C-QTIU-E)	SH-080722ENG
21	Thermocouple Input Module Channel Isolated Thermocouple/Micro Voltage Input Module User's Manual Q64TD Q64TDV-GH GX Configurator-TI (SW1D5C-QTIU-E)	SH-080141
22	Channel Isolated Thermocouple Input Module User's Manual Q68TD-G-H01/Q68TD-G-H02/GX Configurator-TI (SW1D5C-QTIU-E)	SH-080795ENG
23	Temperature Control Module User's Manual Q64TCTT/Q64TCTTBW/Q64TCRT/Q64TCRTBW/GX Configurator-TC (SW0D5C-QTCU-E)	SH-080121
24	High-Speed Counter Module User's Manual QD62/QD62E/QD62D/GX Configurator-CT (SW0D5C-QCTU-E)	SH-080036
25	High Speed Counter Module User's Manual (Hardware) QD62-H01,QD62-H02	IB-0800421
26	Type QD75P/QD75D Positioning Module User's Manual QD75P1/QD75P2/QD75P4,QD75D1/QD75D2/QD75D4	SH-080058
27	User's Manual Type QD75M Positioning Module (Details)	IB-0300062
28	Q Corresponding Serial Communication Module User's Manual (Basic) QJ71C24N,QJ71C24N-R2,QJ71C24N-R4,QJ71C24,QJ71C24-R2,GX Configurator-SC(SW2D5C-QSCU-E)	SH-080006

No.	Manual Name	Manual Number
29	MELSEC-Q/L Serial Communication Module User's Manual (Application) QJ71C24N,QJ71C24N-R2,QJ71C24N-R4,QJ71C24,QJ71C24-R2	SH-080007
30	MELSEC-Q/L MELSEC Communication Protocol Reference Manual QJ71C24N,QJ71C24N-R2,QJ71C24N-R4,QJ71C24,QJ71C24-R2, QJ71E71-100, QJ71E71-B5,QJ71E71-B2	SH-080008
31	Q Corresponding Ethernet Interface Module User's Manual (Basic) QJ71E71-100,QJ71E71-B5,QJ71E71-B2	SH-080009
32	Q Corresponding Ethernet Interface Module User's Manual (Application) QJ71E71-100/ QJ71E71-B5/QJ71E71-B2	SH-080010
33	Q Corresponding Intelligent Communication Module User's Manual QD51,QD51-R24	SH-080089
34	AD51H-BASIC Programming Manual (Command) QD51/QD51-R24/A1SD51S/ AD51H-S3	SH-080090
35	AD51H-BASIC Programming Manual (Debug and Compile) QD51/QD51-R24/ A1SD51S/AD51H-S3	SH-080091
36	MELSEC-Q CC-Link System Master/Local Module User's Manua QJ61BT11N	SH-080394E
37	Q Corresponding MELSECNET/H Network System Reference Manual (PLC to PLC network) QJ71LP21/QJ71LP21-25/QJ71LP21S-25/QJ71LP21G/QJ71LP21GE/ QJ71BR11/QJ71NT11B	SH-080049
38	Q Corresponding MELSECNET/H Network System Reference Manual (Remote I/O network) QJ71LP21,QJ71LP21-25,QJ71LP21S-25,QJ71LP21G,QJ71BR11, QJ72LP25-25,QJ72LP25G,QJ72BR15,QJ71LP21GE,QJ72LP25GE	SH-080124
39	CC-Link/LT Master Module User's Manual QJ61CL12	SH-080351E
40	MELSEC-Q AnyWire DB A20 Master Module User's Manual	SH-080968ENG
41	MELSECNET,MELSECNET/B Local Station Data Link Module User's Manual A1SJ71AP23Q,A1SJ71AR23Q,A1SJ71AT23BQ	SH-080670ENG
42	MELSEC-Q QD73A1 Positioning Module User's Manual	SH-081075ENG

Appendix 3.4 Programming tool

No.	Manual Name	Manual Number
1	GX Works2 Version1 Operating Manual (Common)	SH-080779ENG
2	GX Developer Version 8 Operating Manual	SH-080373E
3	GX Developer Version 8 Operating Manual (SFC)	SH-080374E
4	GX Simulator Version 6 Operating Manual	SH-080169
5	Type SW4IVD-GPPA (GPP) Operating Manual	IB-66855

Appendix 3.5 Products manufactured by Mitsubishi Electric Engineering Co., Ltd.

No.	Catalog name	Catalog Number
1	Mitsubishi Programmable Controller Upgrade Tool	SAN C033E·04Z

Appendix 3.6 Products manufactured by Mitsubishi Electric System & Service Co., Ltd

No.	Data/catalog	Number
1	Renewal tool for A0J2 series Transition from MELSEC-A0J2(H) series to renewal system using renewal tool	X903071003
2	Replace A0J2(H) system with Q series using existing wiring!	X900707-115

WARRANTY

Please confirm the following product warranty details before using this product.

1. Gratis Warranty Term and Gratis Warranty Range

If any faults or defects (hereinafter "Failure") found to be the responsibility of Mitsubishi occurs during use of the product within the gratis warranty term, the product shall be repaired at no cost via the sales representative or Mitsubishi Service Company.

However, if repairs are required onsite at domestic or overseas location, expenses to send an engineer will be solely at the customer's discretion. Mitsubishi shall not be held responsible for any re-commissioning, maintenance, or testing on-site that involves replacement of the failed module.

[Gratis Warranty Term]

The gratis warranty term of the product shall be for one year after the date of purchase or delivery to a designated place. Note that after manufacture and shipment from Mitsubishi, the maximum distribution period shall be six (6) months, and the longest gratis warranty term after manufacturing shall be eighteen (18) months. The gratis warranty term of repair parts shall not exceed the gratis warranty term before repairs.

[Gratis Warranty Range]

- (1) The range shall be limited to normal use within the usage state, usage methods and usage environment, etc., which follow the conditions and precautions, etc., given in the instruction manual, user's manual and caution labels on the product.
- (2) Even within the gratis warranty term, repairs shall be charged for in the following cases.
 1. Failure occurring from inappropriate storage or handling, carelessness or negligence by the user. Failure caused by the user's hardware or software design.
 2. Failure caused by unapproved modifications, etc., to the product by the user.
 3. When the Mitsubishi product is assembled into a user's device, Failure that could have been avoided if functions or structures, judged as necessary in the legal safety measures the user's device is subject to or as necessary by industry standards, had been provided.
 4. Failure that could have been avoided if consumable parts (battery, backlight, fuse, etc.) designated in the instruction manual had been correctly serviced or replaced.
 5. Failure caused by external irresistible forces such as fires or abnormal voltages, and Failure caused by force majeure such as earthquakes, lightning, wind and water damage.
 6. Failure caused by reasons unpredictable by scientific technology standards at time of shipment from Mitsubishi.
 7. Any other failure found not to be the responsibility of Mitsubishi or that admitted not to be so by the user.

2. Onerous repair term after discontinuation of production

- (1) Mitsubishi shall accept onerous product repairs for seven (7) years after production of the product is discontinued. Discontinuation of production shall be notified with Mitsubishi Technical Bulletins, etc.
- (2) Product supply (including repair parts) is not available after production is discontinued.

3. Overseas service

Overseas, repairs shall be accepted by Mitsubishi's local overseas FA Center. Note that the repair conditions at each FA Center may differ.

4. Exclusion of loss in opportunity and secondary loss from warranty liability

Regardless of the gratis warranty term, Mitsubishi shall not be liable for compensation to:

- (1) Damages caused by any cause found not to be the responsibility of Mitsubishi.
- (2) Loss in opportunity, lost profits incurred to the user by Failures of Mitsubishi products.
- (3) Special damages and secondary damages whether foreseeable or not, compensation for accidents, and compensation for damages to products other than Mitsubishi products.
- (4) Replacement by the user, maintenance of on-site equipment, start-up test run and other tasks.

5. Changes in product specifications

The specifications given in the catalogs, manuals or technical documents are subject to change without prior notice.

Microsoft and Windows are either registered trademarks or trademarks of Microsoft Corporation in the United States and/or other countries.

Unicode is either a registered trademark or a trademark of Unicode, Inc. in the United States and other countries.

The company names, system names and product names mentioned in this manual are either registered trademarks or trademarks of their respective companies.

In some cases, trademark symbols such as '™' or '®' are not specified in this manual.

Programmable Controller

Country/Region	Sales office	Tel/Fax
USA	MITSUBISHI ELECTRIC AUTOMATION, INC. 500 Corporate Woods Parkway, Vernon Hills, IL 60061, U.S.A.	Tel : +1-847-478-2100 Fax : +1-847-478-2253
Mexico	MITSUBISHI ELECTRIC AUTOMATION, INC. Mexico Branch Mariano Escobedo #69, Col. Zona Industrial, Tlalnepantla Edo. Mexico, C.P.54030	Tel : +52-55-3067-7500
Brazil	MITSUBISHI ELECTRIC DO BRASIL COMÉRCIO E SERVIÇOS LTDA. Avenida Adelino Cardana, 293, 21 andar, Bethaville, Barueri SP, Brazil	Tel : +55-11-4689-3000 Fax : +55-11-4689-3016
Germany	MITSUBISHI ELECTRIC EUROPE B.V. German Branch Mitsubishi-Electric-Platz 1, 40882 Ratingen, Germany	Tel : +49-2102-486-0 Fax : +49-2102-486-1120
UK	MITSUBISHI ELECTRIC EUROPE B.V. UK Branch Travellers Lane, Hatfield, Hertfordshire, AL10 8XB, U.K.	Tel : +44-1707-28-8780 Fax : +44-1707-27-8695
Ireland	MITSUBISHI ELECTRIC EUROPE B.V. Irish Branch Westgate Business Park, Ballymount, Dublin 24, Ireland	Tel : +353-1-4198800 Fax : +353-1-4198890
Italy	MITSUBISHI ELECTRIC EUROPE B.V. Italian Branch Centro Direzionale Colleoni-Palazzo Sirio Viale Colleoni 7, 20864 Agrate Brianza(Milano) Italy	Tel : +39-039-60531 Fax : +39-039-6053-312
Spain	MITSUBISHI ELECTRIC EUROPE, B.V. Spanish Branch Carretera de Rubí, 76-80-Apdo. 420, 08190 Sant Cugat del Vallés (Barcelona), Spain	Tel : +34-935-65-3131 Fax : +34-935-89-1579
France	MITSUBISHI ELECTRIC EUROPE B.V. French Branch 25, Boulevard des Bouvets, 92741 Nanterre Cedex, France	Tel : +33-1-55-68-55-68 Fax : +33-1-55-68-57-57
Czech Republic	MITSUBISHI ELECTRIC EUROPE B.V. Czech Branch Avenir Business Park, Radlicka 751/113e, 158 00 Praha5, Czech Republic	Tel : +420-251-551-470 Fax : +420-251-551-471
Poland	MITSUBISHI ELECTRIC EUROPE B.V. Polish Branch ul. Krakowska 50, 32-083 Balice, Poland	Tel : +48-12-347-65-00 Fax : +48-12-630-47-01
Sweden	MITSUBISHI ELECTRIC EUROPE B.V. (Scandinavia) Fjellievägen 8, SE-22736 Lund, Sweden	Tel : +46-8-625-10-00 Fax : +46-46-39-70-18
Russia	MITSUBISHI ELECTRIC (RUSSIA) LLC St. Petersburg Branch Piskarevsky pr. 2, bld 2, lit "Sch", BC "Benuea", office 720; 195027 St. Petersburg, Russia	Tel : +7-812-633-3497 Fax : +7-812-633-3499
Turkey	MITSUBISHI ELECTRIC TURKEY A.Ş Ümraniye Branch Serifali Mah. Kale Sok. No:41 34775 Umraniye - Istanbul, Turkey	Tel : +90-216-969-2500 Fax : +90-216-526-3995
UAE	MITSUBISHI ELECTRIC EUROPE B.V. Dubai Branch Dubai Silicon Oasis, P.O.BOX 341241, Dubai, U.A.E.	Tel : +971-4-3724716 Fax : +971-4-3724721
South Africa	ADROIT TECHNOLOGIES 20 Waterford Office Park, 189 Witkoppen Road, Fourways, South Africa	Tel : +27-11-658-8100 Fax : +27-11-658-8101
China	MITSUBISHI ELECTRIC AUTOMATION (CHINA) LTD. No.1386 Hongqiao Road, Mitsubishi Electric Automation Center, Shanghai, China	Tel : +86-21-2322-3030 Fax : +86-21-2322-3000
Taiwan	SETSUYO ENTERPRISE CO., LTD. 6F, No.105, Wugong 3rd Road, Wugu District, New Taipei City 24889, Taiwan	Tel : +886-2-2299-2499 Fax : +886-2-2299-2509
Korea	MITSUBISHI ELECTRIC AUTOMATION KOREA CO., LTD. 7F-9F, Gangseo Hangang Xi-tower A, 401, Yangcheon-ro, Gangseo-Gu, Seoul 07528, Korea	Tel : +82-2-3660-9530 Fax : +82-2-3664-8372
Singapore	MITSUBISHI ELECTRIC ASIA PTE. LTD. 307, Alexandra Road, Mitsubishi Electric Building, Singapore 159943	Tel : +65-6473-2308 Fax : +65-6476-7439
Thailand	MITSUBISHI ELECTRIC FACTORY AUTOMATION (THAILAND) CO., LTD. 12th Floor, SV.City Building, Office Tower 1, No. 896/19 and 20 Rama 3 Road, Kwaeng Bangpongpan, Khet Yannawa, Bangkok 10120, Thailand	Tel : +66-2682-6522 Fax : +66-2682-6020
Vietnam	MITSUBISHI ELECTRIC VIETNAM COMPANY LIMITED Hanoi Branch 6th Floor, Detech Tower, 8 Ton That Thuyet Street, My Dinh 2 Ward, Nam Tu Liem District, Hanoi, Vietnam	Tel : +84-4-3937-8075 Fax : +84-4-3937-8076
Malaysia	MITSUBISHI ELECTRIC SALES MALAYSIA SDN. BHD. Lot 11, Jalan 219, 46100 Petaling Jaya, Selangor Darul Ehsan, Malaysia	Tel : +60-3-7626-5000 Fax : +60-3-7658-3544
Indonesia	PT. MITSUBISHI ELECTRIC INDONESIA Gedung Jaya 11th Floor, JL. MH. Thamrin No.12, Jakarta Pusat 10340, Indonesia	Tel : +62-21-3192-6461 Fax : +62-21-3192-3942
India	MITSUBISHI ELECTRIC INDIA PVT. LTD. Pune Branch Emerald House, EL-3, J Block, M.I.D.C., Bhosari, Pune-411026, Maharashtra, India	Tel : +91-20-2710-2000 Fax : +91-20-2710-2100
Australia	MITSUBISHI ELECTRIC AUSTRALIA PTY. LTD. 348 Victoria Road, P.O. Box 11, Rydalmere, N.S.W 2116, Australia	Tel : +61-2-9684-7777 Fax : +61-2-9684-7245

MITSUBISHI ELECTRIC CORPORATION

HEAD OFFICE: TOKYO BUILDING, 2-7-3, MARUNOUCHI, CHIYODA-KU, TOKYO 100-8310, JAPAN
NAGOYA WORKS: 1-14, YADA-MINAMI 5, HIGASHI-KU, NAGOYA, JAPAN