



for a greener tomorrow

FACTORY AUTOMATION

INVERTER FR-D700

Global standard

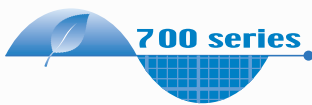

- Pursuing the easy operation
- Long life and simple maintenance
- Compact and space-saving
- Supporting various applications

GLOBAL IMPACT OF MITSUBISHI ELECTRIC



Through Mitsubishi Electric's vision, "Changes for the Better" are possible for a brighter future.

Changes for the Better

We bring together the best minds to create the best technologies. At Mitsubishi Electric, we understand that technology is the driving force of change in our lives. By bringing greater comfort to daily life, maximizing the efficiency of businesses and keeping things running across society, we integrate technology and innovation to bring changes for the better.

Mitsubishi Electric is involved in many areas including the following

Energy and Electric Systems

A wide range of power and electrical products from generators to large-scale displays.

Electronic Devices

A wide portfolio of cutting-edge semiconductor devices for systems and products.

Home Appliance

Dependable consumer products like air conditioners and home entertainment systems.

Information and Communication Systems

Commercial and consumer-centric equipment, products and systems.

Industrial Automation Systems

Maximizing productivity and efficiency with cutting-edge automation technology.

Features	4
Standard Specifications	8
Outline Dimension Drawings	11
Terminal Connection Diagram, Terminal Specification Explanation	14
Explanation of Operation Panel, Parameter Unit	16
Parameter List	19
Protective Functions	26
Options and peripheral devices	27
Precautions for Operation/Selection, Precautions for Peripheral Device Selection	30
FR-D700 Series Specification Difference List	35
Warranty, Inquiry	36

GLOBAL STANDARD

1 New standard of inverter

Highly reliable inverter!

(1) Safety stop function

The FR-D700 series is compliant to the EU Machinery Directive without the addition of previously required external devices. Operation of an external Emergency Stop device results in a highly reliable immediate shutoff of the D700's output to the motor. This safety stop function conforms to the following standards.

EN ISO 13849-1 Category 3 / PLD

EN62061 / IEC61508 SIL2

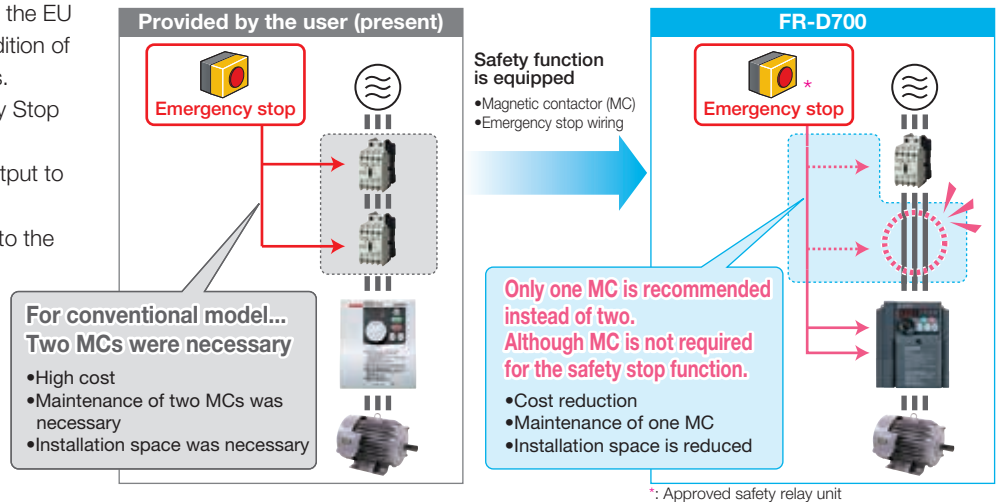

(2) Spring clamp terminal (control circuit terminal)

With spring clamp terminals*, the wiring became easier and more secure.

*: Main circuit terminal is screw terminal.

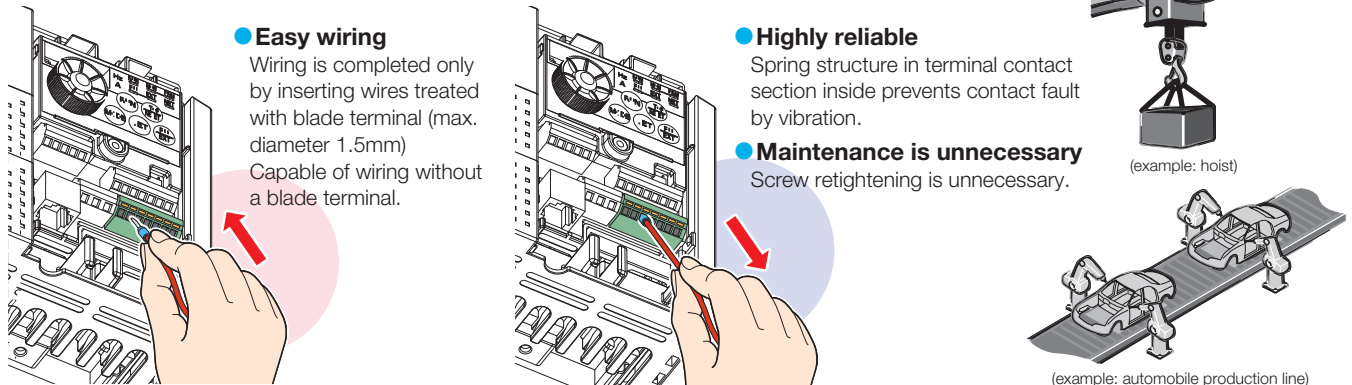

(3) Long-life design

- The design life of the cooling fan has been extended to 10 years*¹. The life of the fan can be further extended utilizing the it's ON/OFF control.
- The design life of the capacitors has been extended to 10 years*¹*² by adopting a capacitor that endures about 5000 hours at 105°C surrounding air temperature.

*¹: Surrounding air temperature : annual average 40°C (free from corrosive gas, flammable gas, oil mist, dust and dirt) Since the design life is a calculated value, it is not a guaranteed value.

*²: Output current : 80% of the inverter rated current

- Estimated service lifespan of the long-life parts

Components	Estimated lifespan of the FR-D700	Guideline of JEMA
Cooling fan	10 years	2 to 3 years
Main circuit smoothing capacitor	10 years	5 years
Printed board smoothing capacitor	10 years	5 years

*³: Excerpts from "Periodic check of the transistorized inverter" of JEMA (Japan Electrical Manufacture's Association)

(4) Leading life check function

- Degrees of deterioration of main circuit capacitor, control circuit capacitor, and inrush current limit circuit can be monitored.
- Trouble can be avoided with the self-diagnostic alarm*⁴ that is output when the life span is near.

*⁴: If any one of main circuit capacitor, control circuit capacitor, inrush current restriction circuit or cooling fan reaches the output level, an alarm is output. Capacity of the main circuit capacitor can be measured by setting parameter at a stop and turning the power from off to on. Measuring the capacity enables alarm to be output. The cooling fan outputs alarm by using fan speed detection.

(5) Password function

Registering a 4-digit password can limit parameter read/write. It is effective for parameter setting protection.



2 Mitsubishi's new standard (As of April 2008)

Compact yet equipped with highest level of function/performance!!

(1) 150%/1Hz high starting torque by General-purpose magnetic flux vector control

General-purpose magnetic flux vector control and auto tuning function are available.

It ensures operation that requires high starting torque, such as transfer machine including conveyer, hoist, lift, etc., washing machine, and agitators.

- High torque of 150%/1Hz and 200%/3Hz (3.7K or less) is realized (when the slip compensation function is valid).

- Auto tuning

Many kinds of motors can be optimally controlled with Mitsubishi original "non-rotation" auto tuning function. (R1 constants tuning)

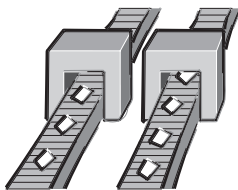

(example: conveyer)

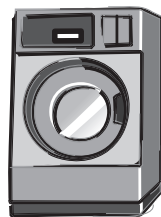

(example: industrial washing machine)

(2) Brake resistor can be connected

A brake transistor is built-in to the 0.4K or more. Connecting an optional brake resistor increases regeneration capability.

It is useful for deceleration time reduction of a machine with a large inertia, such as fan, and operation of lift, etc.

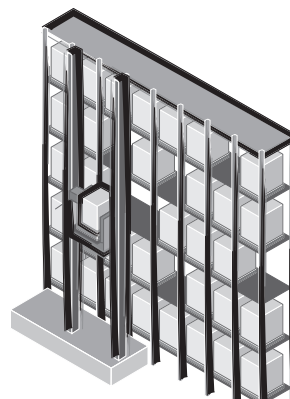

(example: automated storage)

(3) Enhanced function

New functions and useful functions from superior models support all sorts of applications.

• Regeneration avoidance function

For a pressing machine and fan rotated faster than the set speed due to the effect of another fan, a trip is less likely to occur by automatically increasing frequency at regeneration.



(example: pressing machine)

• Optimum excitation control

This control enables the motor efficiency to its optimum. More energy saving is possible in applications with variable load torque characteristic such as fan and pump.

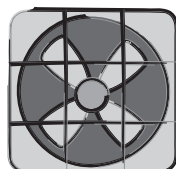

(example: air-conditioning fan)

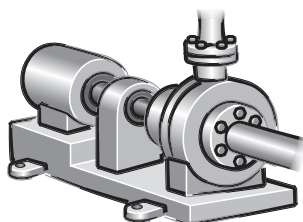

(example: pump)

• Power failure-time deceleration-to-stop function

The motor can be decelerated to a stop when a power failure or undervoltage occur to prevent the motor from coasting.

For fail-safe of machine tool, etc., it is effective to stop the motor when a power failure occurs.

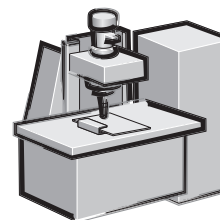

(example: spindle)

• Dancer control

Entering position detection signal of dancer roll to use PID control enables tension control by dancer roll.

• Traverse function

Traverse function for wind-up drum of spinning machine and wiredrawing machine prevents unevenness and deformation at thread winding.

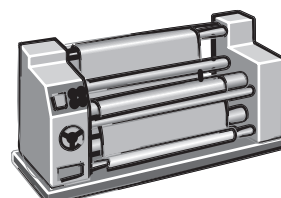

(example: textile machine)

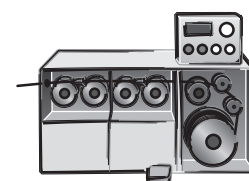

(example: wiredrawing machine)

- Features

- Standard specifications

- Outline dimension drawings

- Terminal connection diagram
- Terminal specification explanation

- Operation panel
- Parameter unit

- Parameter list

- Protective functions

- Option and peripheral devices

- Precautions for operation/selection
- Precautions for peripheral device selection

- FR-D700 Series Specification Difference List

- Warranty
- International FA Center

3 Easy use and time saving built-in as standard

(1) Quick setup with the setting dial

Setting dial is the feature of Mitsubishi inverters.

- Displayed numbers can be jumped by turning the setting dial quickly, and numbers can be changed one by one by turning it slowly, enabling speedy parameter setting.
- The nonslip setting dial is easier to turn.



(2) Easy setting from a personal computer using the FR Configurator (option)

Connecting a personal computer and the inverter via RS-485 communication enables setting with wizard (interactive) function of the FR Configurator (inverter setup software).

In addition, a parameter setting can be converted from the FR-S500 series to the FR-D700 series by "Convert" function. "Graph" function displays monitor data in waveform.



Setting wizard function (example: acceleration/deceleration time setting)

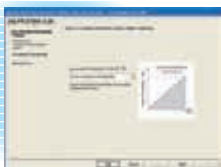

Acceleration/deceleration pattern setting



Acceleration/deceleration time setting



Parameter list display

(3) Enclosure surface operation panel FR-PA07 (option)

Optional enclosure surface operation panel (FR-PA07) can be connected. In addition, an operation panel for the FR-E500 series can be connected.

The operation panel of the inverter can not be removed. A parameter unit connection cable (FR-CB20□) is separately necessary.



(4) Parameter unit FR-PU07 (option)

An optional parameter unit (FR-PU07) can be connected as well. A parameter unit connection cable (FR-CB20□) is separately necessary.

- Setting such as direct input method with a numeric keypad, operation status indication, and help function are usable. Eight languages can be displayed.
- Parameter setting values of maximum of three inverters can be stored.



(5) Enhanced communication function

• Mitsubishi inverter protocol and MODBUS®RTU

Communication speed of RS-485 has been improved (communication at 38.4kbps is available)

"Multi command mode" has been added to Mitsubishi inverter protocol (data processing time of the inverter has been reduced to 1/4)
Supports MODBUS®RTU

4 Compact and space saving

(1) Easily replaceable compact body

Installation size is the same as that of the FR-S500 series which is the smallest model of the Mitsubishi inverter.



FR-D740-0.4K

FR-S540E-0.4K

(2) Side by side installation saves space

Space can be saved by side by side no clearance installation*.

*: Use the inverter at the surrounding air temperature of 40°C or less.



Introducing the Mitsubishi magnetic contactor

- Offers a selection of small frames
- Offers a line-up of safety contactors
- Supports small loads (auxiliary contact)
- Supports many international regulations as standard



Refer to page 28 for the selection.

5 Easy maintenance

(1) Easy replacement of cooling fan

A cooling fan is provided on top of the inverter of all capacities requiring a cooling fan (1.5K or more).

A cooling fan can be easily replaced without disconnecting main circuit wires.



(2) Combed shaped wiring cover

Since a cover can be fitted after wiring, wiring work is easily done.



6 Environment consciousness in global standard

(1) EU RoHS Directive compliant

Human and environment-friendly inverter in compliant with RoHS Directive.

RoHS Directive requires member nations to guarantee that new electrical and electronic equipment sold in the market after July 1, 2006 do not contain lead, cadmium, mercury, hexavalent chromium, polybrominated biphenyl (PBB) and polybrominated diphenyl ether (PBDE) flame retardants.

<G> mark indicating RoHS Directive compliance is printed on the package.

(2) Filterpack FR-BFP2 (option)

Power factor improving DC reactor, zero phase reactor, and capacitive filter (radio noise filter), are frequently-used units for an air conditioning application. The filterpack combines those three units are available as an option.

(3) EMC Directive compliant noise filter

Compliance to the EMC Directive of European Norm is easier.

- Noise filter option which is compatible with EMC Directive (EN61800-3 2nd Environment Category C3) is available.

(4) Compliance with a variety of standards

Complies with UL, cUL, and EC Directives (CE marking), and the Radio Waves Act (South Korea) (KC marking). It is also certified as compliant with the Eurasian Conformity (EAC).



The single-phase 100V power input model is not compliant with the EMC Directive.

7 Lineup

The lineup of three phase 200V/400V class goes to 15K.

- For a use in harsh environment, special unit with board coating is also available. Please contact our sales representative.
- For the FR-D700 series, North American (NA), EU (EC), and Chinese (CHT) specifications also are supported.

*: This catalog explains based on the Japanese specifications.
Consult our sales office for specifications of each country.

FR-D740 **-0.4K**

Symbol	Voltage
1	100V class
2	200V class
4	400V class

Symbol	Number of Power Phases
None	Three-phase input
S	Single-phase input
W	Single-phase input (double voltage output)

Symbol	Inverter Capacity
0.1K to 15K	Indicate capacity "kW".

Power Supply	Inverter Model	0.1	0.2	0.4	0.75	1.5	2.2	3.7	5.5	7.5	11	15
Three phase 200V	FR-D720-□K	●	●	●	●	●	●	●	●	●	●	●
Three phase 400V	FR-D740-□K	—	—	●	●	●	●	●	●	●	●	●
Single phase 200V*	FR-D720S-□K	●	●	●	●	●	●	—	—	—	—	—
Single phase 100V*	FR-D710W-□K	●	●	●	●	—	—	—	—	—	—	—

*: Output of the single-phase 200V and single-phase 100V input models is three-phase 200V.

●: Available models

—: Not available

Standard specifications

Rating

● Three-phase 200V power supply

Model FR-D720-□K		0.1	0.2	0.4	0.75	1.5	2.2	3.7	5.5	7.5	11	15
Model FR-D720-□-NA		008	014	025	042	070	100	165	238	318	—	—
Applicable motor capacity (kW)*1		0.1	0.2	0.4	0.75	1.5	2.2	3.7	5.5	7.5	11	15
Output	Rated capacity (kVA)*2	0.3	0.6	1.0	1.7	2.8	4.0	6.6	9.5	12.7	17.9	23.1
	Rated current (A)	0.8	1.4	2.5	4.2	7.0	10.0	16.5	23.8	31.8	45.0	58.0
	Overload current rating*3	150% 60s, 200% 0.5s (inverse-time characteristics)										
	Rated voltage*4	Three-phase 200 to 240V										
	Regenerative braking torque*5	150%			100%			50%			20%	
Power supply	Rated input AC voltage/frequency	Three-phase 200 to 240V 50Hz/60Hz										
	Permissible AC voltage fluctuation	170 to 264V 50Hz/60Hz										
	Permissible frequency fluctuation	±5%										
	Power supply capacity (kVA)*6	0.4	0.7	1.2	2.1	4.0	5.5	9.0	12.0	17.0	20.0	27.0
Protective structure (JEM1030)		Enclosed type (IP20)										
Cooling system		Self-cooling					Forced air cooling					
Approximate mass (kg)		0.5	0.5	0.8	1.0	1.4	1.4	1.8	3.6	3.6	6.5	6.5

● Three-phase 400V power supply

Model FR-D740-□K		0.4	0.75	1.5	2.2	3.7	5.5	7.5	11	15	
Model FR-D740-□-NA		012	022	036	050	080	120	160	—	—	
Model FR-D740-□(SC)-EC		012	022	036	050	080	120	160	—	—	
Model FR-D740-□K-CHT		0.4	0.75	1.5	2.2	3.7	5.5	7.5	—	—	
Applicable motor capacity (kW)*1		0.4	0.75	1.5	2.2	3.7	5.5	7.5	11	15	
Output	Rated capacity (kVA)*2	0.9	1.7	2.7	3.8	6.1	9.1	12.2	17.5	22.5	
	Rated current (A)	1.2	2.2	3.6	5.0	8.0	12.0	16.0	23.0	29.5	
	Overload current rating*3	150% 60s, 200% 0.5s (inverse-time characteristics)									
	Rated voltage*4	Three-phase 380 to 480V									
	Regenerative braking torque*5	100%			50%			20%			
Power supply	Rated input AC voltage/frequency	Three-phase 380 to 480V 50Hz/60Hz									
	Permissible AC voltage fluctuation	325 to 528V 50Hz/60Hz									
	Permissible frequency fluctuation	±5%									
	Power supply capacity (kVA)*6	1.5	2.5	4.5	5.5	9.5	12.0	17.0	20.0	28.0	
Protective structure (JEM1030)		Enclosed type (IP20)									
Cooling system		Self-cooling				Forced air cooling					
Approximate mass (kg)		1.3	1.3	1.4	1.5	1.5	3.3	3.3	6.0	6.0	

*1 The applicable motor capacity indicated is the maximum capacity applicable for use of the Mitsubishi 4-pole standard motor.

*2 The rated output capacity indicated assumes that the output voltage is 230V for three-phase 200V class and 440V for three-phase 400V class.

*3 The % value of the overload current rating indicated is the ratio of the overload current to the inverter's rated output current. For repeated duty, allow time for the inverter and motor to return to or below the temperatures under 100% load.

*4 The maximum output voltage does not exceed the power supply voltage. The maximum output voltage can be changed within the setting range. However, the pulse voltage value of the inverter output side voltage remains unchanged at about $\sqrt{2}$ that of the power supply.

*5 The braking torque indicated is a short-duration average torque (which varies with motor loss) when the motor alone is decelerated from 60Hz in the shortest time and is not a continuous regenerative torque. When the motor is decelerated from the frequency higher than the base frequency, the average deceleration torque will reduce. Since the inverter does not contain a brake resistor, use the optional brake resistor when regenerative energy is large. (The option brake resistor cannot be used for 0.1K and 0.2K.) A brake unit (FR-BU2) may also be used.

*6 The power supply capacity varies with the value of the power supply side inverter impedance (including those of the input reactor and cables).

● Single-phase 200V power supply

Model FR-D720S-□K		0.1	0.2	0.4	0.75	1.5	2.2
Model FR-D720S-□-NA		008	014	025	042	070	100
Model FR-D720S-□(SC)-EC		008	014	025	042	070	100
Model FR-D720S-□K-CHT		0.1	0.2	0.4	0.75	1.5	2.2
Applicable motor capacity (kW)*1		0.1	0.2	0.4	0.75	1.5	2.2
Output	Rated capacity (kVA)*2	0.3	0.6	1.0	1.7	2.8	4.0
	Rated current (A)	0.8	1.4	2.5	4.2	7.0	10.0
	Overload current rating*3	150% 60s, 200% 0.5s (inverse-time characteristics)					
	Rated voltage*4	Three-phase 200 to 240V					
	Regenerative braking torque*5	150%		100%		50% 20%	
Power supply	Rated input AC voltage/frequency	Single-phase 200 to 240V 50Hz/60Hz					
	Permissible AC voltage fluctuation	170 to 264V 50Hz/60Hz					
	Permissible frequency fluctuation	±5%					
	Power supply capacity (kVA)*6	0.5	0.9	1.5	2.3	4.0	5.2
Protective structure (JEM1030)		Enclosed type (IP20)					
Cooling system		Self-cooling				Forced air cooling	
Approximate mass (kg)		0.5	0.5	0.9	1.1	1.5	2.0

● Single-phase 100V power supply

Model FR-D710W-□K		0.1	0.2	0.4	0.75
Model FR-D710W-□-NA		008	014	025	042
Applicable motor capacity (kW)*1		0.1	0.2	0.4	0.75
Output	Rated capacity (kVA)*2	0.3	0.6	1.0	1.7
	Rated current (A)	0.8	1.4	2.5	4.2
	Overload current rating*3	150% 60s, 200% 0.5s (inverse-time characteristics)			
	Rated voltage	Three-phase 200 to 230V*7, *8			
	Regenerative braking torque*5	150%		100%	
Power supply	Rated input AC voltage/frequency	Single-phase 100 to 115V 50Hz/60Hz			
	Permissible AC voltage fluctuation	90 to 132V 50Hz/60Hz			
	Permissible frequency fluctuation	±5%			
	Power supply capacity (kVA)*6	0.5	0.9	1.5	2.5
Protective structure (JEM1030)		Enclosed type (IP20)			
Cooling system		Self-cooling			
Approximate mass (kg)		0.6	0.7	0.9	1.4

*1 The applicable motor capacity indicated is the maximum capacity applicable for use of the Mitsubishi 4-pole standard motor.

*2 The rated output capacity indicated assumes that the output voltage is 230V.

*3 The % value of the overload current rating indicated is the ratio of the overload current to the inverter's rated output current. For repeated duty, allow time for the inverter and motor to return to or below the temperatures under 100% load. If the automatic restart after instantaneous power failure function (Pr: 57) or power failure stop function (Pr: 261) is set and power supply voltage is low while load becomes bigger, the bus voltage decreases to power failure detection level and load of 100% or more may not be available.

*4 The maximum output voltage does not exceed the power supply voltage. The maximum output voltage can be changed within the setting range. However, the pulse voltage value of the inverter output side voltage remains unchanged at about $\sqrt{2}$ that of the power supply.

*5 The braking torque indicated is a short-duration average torque (which varies with motor loss) when the motor alone is decelerated from 60Hz in the shortest time and is not a continuous regenerative torque. When the motor is decelerated from the frequency higher than the base frequency, the average deceleration torque will reduce. Since the inverter does not contain a brake resistor, use the optional brake resistor when regenerative energy is large. (The option brake resistor cannot be used for 0.1K and 0.2K.) A brake unit (FR-BU2) may also be used.

*6 The power supply capacity varies with the value of the power supply side inverter impedance (including those of the input reactor and cables).

*7 For single-phase 100V power input model, the maximum output voltage is twice the amount of the power supply voltage and cannot be exceeded.

*8 In a single-phase 100V power input model, the output voltage may fall down when the load is heavy, and larger output current may flow compared to a three-phase input model. Use the motor with less load so that the output current is within the rated motor current range.

Features

Standard Specifications

Outline Dimension Drawings

Terminal Connection Diagram Terminal Specification Explanation

Operation panel Parameter unit

Parameter List

Protective Functions

Options

Instructions

FR-D700 Series Specification Difference List

Warranty International FA Center

Common specifications

Control specifications	Control method		Soft-PWM control/high carrier frequency PWM control (V/F control, General-purpose magnetic flux vector control, and Optimum excitation control are available)
	Output frequency range		0.2 to 400Hz
	Frequency setting resolution	Analog input	0.06Hz/60Hz (terminal2, 4: 0 to 10V/10 bits) 0.12Hz/60Hz (terminal2, 4: 0 to 5V/9 bits) 0.06Hz/60Hz (terminal4: 0 to 20mA/10 bits)
		Digital input	0.01Hz
	Frequency accuracy	Analog input	Within ±1% of the max. output frequency (25°C ±10°C)
		Digital input	Within 0.01% of the set output frequency
	Voltage/frequency characteristics		Base frequency can be set from 0 to 400Hz. Constant-torque/variable torque pattern can be selected
	Starting torque		150% or more (at 1Hz)...when General-purpose magnetic flux vector control and slip compensation is set
	Torque boost		Manual torque boost
	Acceleration/deceleration time setting		0.1 to 3600s (acceleration and deceleration can be set individually), Linear and S-pattern acceleration/deceleration modes are available.
DC injection brake		Operation frequency (0 to 120Hz), operation time (0 to 10s), and operation voltage (0 to 30%) can be changed	
Stall prevention operation level		Operation current level (0 to 200%), and whether to use the function or not can be selected	
Operation specifications	Frequency setting signal	Analog input	Two terminals Terminal 2: 0 to 10V and 0 to 5V are available Terminal 4: 0 to 10V, 0 to 5V, and 4 to 20mA are available
		Digital input	The signal is entered from the operation panel or parameter unit. Frequency setting increment can be set.
	Start signal		Forward and reverse rotation or start signal automatic self-holding input (3-wire input) can be selected.
	Input signal (five terminals)		The following signals can be assigned to <i>Pr.178 to Pr.182 (input terminal function selection)</i> : multi-speed selection, remote setting, second function selection, terminal 4 input selection, JOG operation selection, PID control valid terminal, external thermal input, PU-External operation switchover, V/F switchover, output stop, start self-holding selection, forward rotation, reverse rotation command, inverter reset, PU-NET operation switchover, External-NET operation switchover, command source switchover, inverter operation enable signal, and PU operation external interlock.
	Operational functions		Maximum/minimum frequency setting, frequency jump operation, external thermal relay input selection, automatic restart after instantaneous power failure operation, forward/reverse rotation prevention, remote setting, second function, multi-speed operation, regeneration avoidance, slip compensation, operation mode selection, offline auto tuning function, PID control, computer link operation (RS-485), Optimum excitation control, power failure stop, speed smoothing control, MODBUS RTU
	Output signal		The following signals can be assigned to <i>Pr.190, Pr.192 and Pr.197 (output terminal function selection)</i> : inverter operation, up-to-frequency, overload alarm, output frequency detection, regenerative brake pre-alarm, electronic thermal relay function pre-alarm, inverter operation ready, output current detection, zero current detection, PID lower limit, PID upper limit, PID forward/reverse rotation output, fan alarm*1, heatsink overheat pre-alarm, deceleration at an instantaneous power failure, PID control activated, PID output interruption, safety monitor output, safety monitor output 2, during retry, life alarm, current average value monitor, remote output, alarm output, fault output, fault output 3, and maintenance timer alarm.
Open collector output (two terminals)		The following signals can be assigned to <i>Pr.54 FM terminal function selection</i> : output frequency, output current (steady), output voltage, frequency setting, converter output voltage, regenerative brake duty, electronic thermal relay function load factor, output current peak value, converter output voltage peak value, reference voltage output, motor load factor, PID set point, PID measured value, output power, PID deviation, motor thermal load factor, and inverter thermal load factor. Pulse train output (1440 pulses/s/full scale)	
Relay output (one terminal)			
Operating status			
For meter Pulse train output (MAX 2.4kHz: one terminal)			
Indication	Operation panel	Operating status	The following operating status can be displayed: output frequency, output current (steady), output voltage, frequency setting, cumulative energization time, actual operation time, converter output voltage, regenerative brake duty, electronic thermal relay function load factor, output current peak value, converter output voltage peak value, motor load factor, PID set point, PID measured value, PID deviation, inverter I/O terminal monitor, output power, cumulative power, motor thermal load factor, inverter thermal load factor, and PTC thermistor resistance.
		Fault record	Fault record is displayed when a fault occurs. Past 8 fault records (output voltage/current/frequency/cumulative energization time right before the fault occurs) are stored.
	Parameter unit (FR-PU07)	Interactive guidance	Function (help) for operation guide *2
Protective/warning function	Protective function		Overcurrent during acceleration, overcurrent during constant speed, overcurrent during deceleration, overvoltage during acceleration, overvoltage during constant speed, overvoltage during deceleration, inverter protection thermal operation, motor protection thermal operation, heatsink overheat, input phase loss *3 *4, output side earth (ground) fault overcurrent at start*3, output short circuit, output phase loss, external thermal relay operation *3, PTC thermistor operation*3, parameter error, PU disconnection, retry count excess *3, CPU fault, brake transistor alarm, inrush resistance overheat, analog input error, stall prevention operation, output current detection value exceeded *3, safety circuit fault
	Warning function		Fan alarm*1, overcurrent stall prevention, overvoltage stall prevention, PU stop, parameter write error, regenerative brake pre-alarm *3, electronic thermal relay function pre-alarm, maintenance output *3, undervoltage, operation panel lock, password locked, inverter reset, safety stop
Environment	Surrounding air temperature		-10°C to +50°C maximum (non-freezing) *5
	Ambient humidity		90%RH or less (non-condensing)
	Storage temperature*6		-20°C to +65°C
	Atmosphere		Indoors (without corrosive gas, flammable gas, oil mist, dust and dirt etc.)
	Altitude/vibration		Maximum 1000m above sea level, 5.9m/s ² or less at 10 to 55Hz (directions of X, Y, Z axes)

*1 As the 0.75K or lower are not provided with the cooling fan, this alarm does not function.

*2 This operation guide is only available with option parameter unit (FR-PU07).

*3 This protective function is not available in the initial status.

*4 This protective function is available with the three-phase power input specification model only.

*5 When using the inverters at the surrounding air temperature of 40°C or less, the inverters can be installed closely attached (0cm clearance).

*6 Temperatures applicable for a short time, e.g. in transit.

Outline Dimension Drawings

- FR-D720-0.1K to 0.75K
- FR-D720S-0.1K to 0.75K
- FR-D710W-0.1K to 0.4K

1-φ5 hole

5

56

68

5

5

118

128

Rating plate

4

D

D1

Inverter Model	D	D1
FR-D720-0.1K, 0.2K FR-D720S-0.1K, 0.2K FR-D710W-0.1K	80.5	10
FR-D710W-0.2K	110.5	10
FR-D720-0.4K	112.5	42
FR-D720-0.75K	132.5	62
FR-D720S-0.4K FR-D710W-0.4K	142.5	42
FR-D720S-0.75K	162.5	62

(Unit: mm)

- FR-D720-1.5K to 3.7K
- FR-D740-0.4K to 3.7K
- FR-D720S-1.5K
- FR-D710W-0.75K

2-φ5 hole

5

5

W1

W

5

118

128

Rating plate

FAN *

5

D

D1

* FR-D740-0.4K, 0.75K, FR-D710W-0.75K are not provided with the cooling fan.

Inverter Model	W	W1	D	D1
FR-D720-1.5K, 2.2K FR-D740-1.5K	108	96	135.5	60
FR-D740-0.4K, 0.75K			129.5	54
FR-D740-2.2K FR-D720S-1.5K			155.5	60
FR-D740-3.7K			165.5	60
FR-D710W-0.75K	170	158	149.5	54
FR-D720-3.7K			142.5	66.5

(Unit: mm)

- Features
- Standard Specifications
- Outline Dimension Drawings
- Terminal Connection Diagram
- Terminal Specification Explanation
- Operation panel Parameter unit
- Parameter List
- Protective Functions
- Options
- Instructions
- FR-D700 Series Specification Difference List
- Warranty International FA Center

●FR-D720S-2.2K

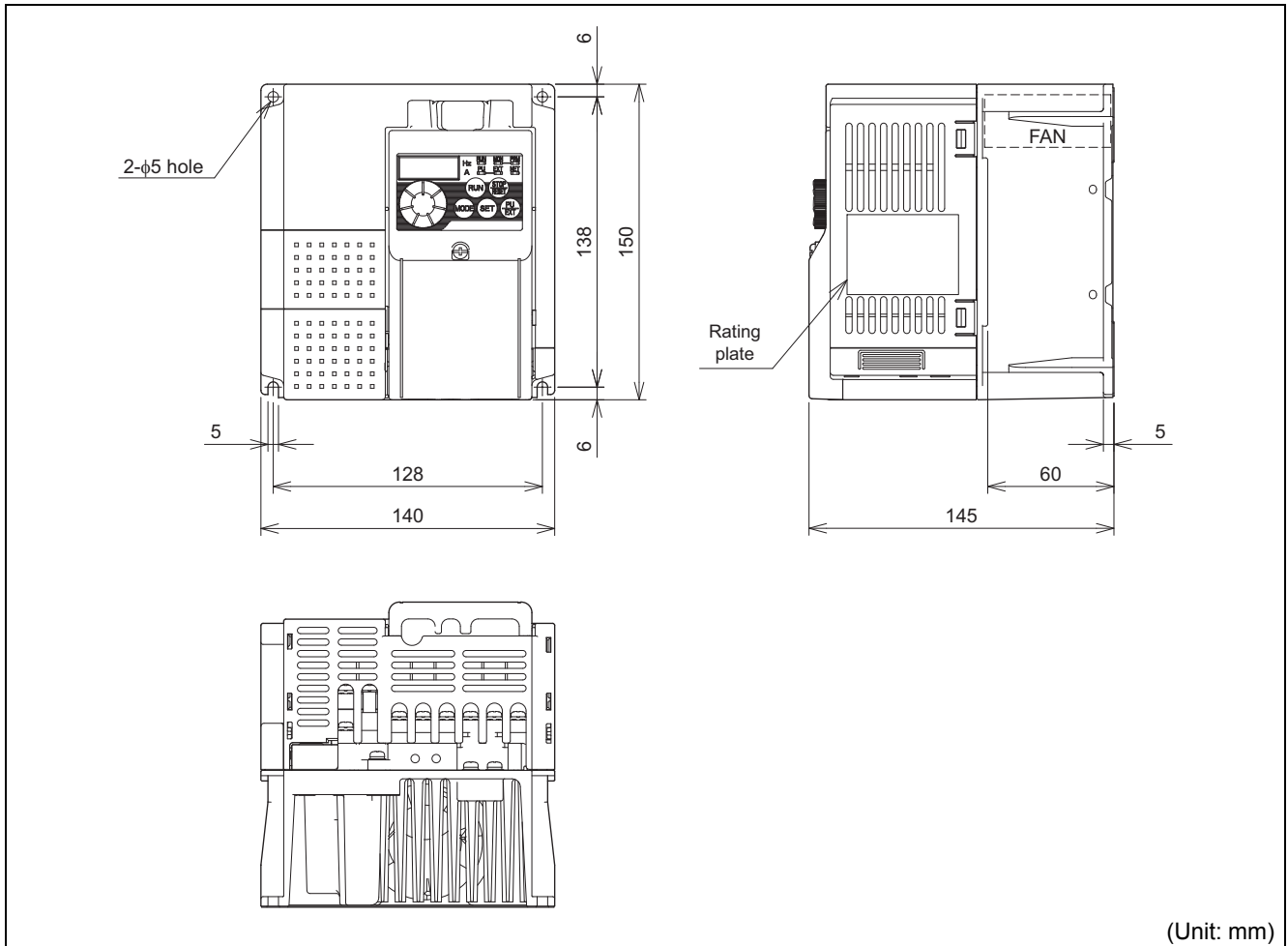

●FR-D720-5.5K, 7.5K
●FR-D740-5.5K, 7.5K

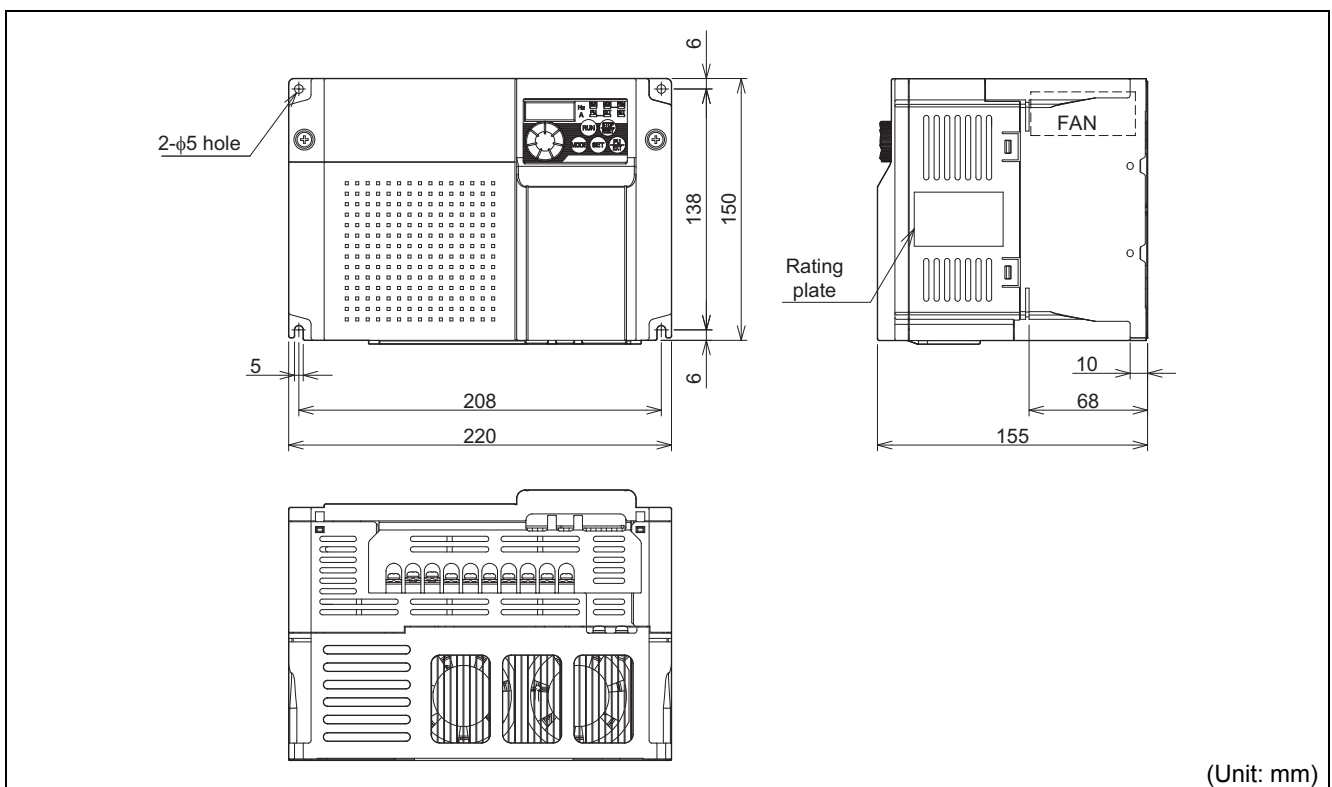

- FR-D720-11K, 15K
- FR-D740-11K, 15K

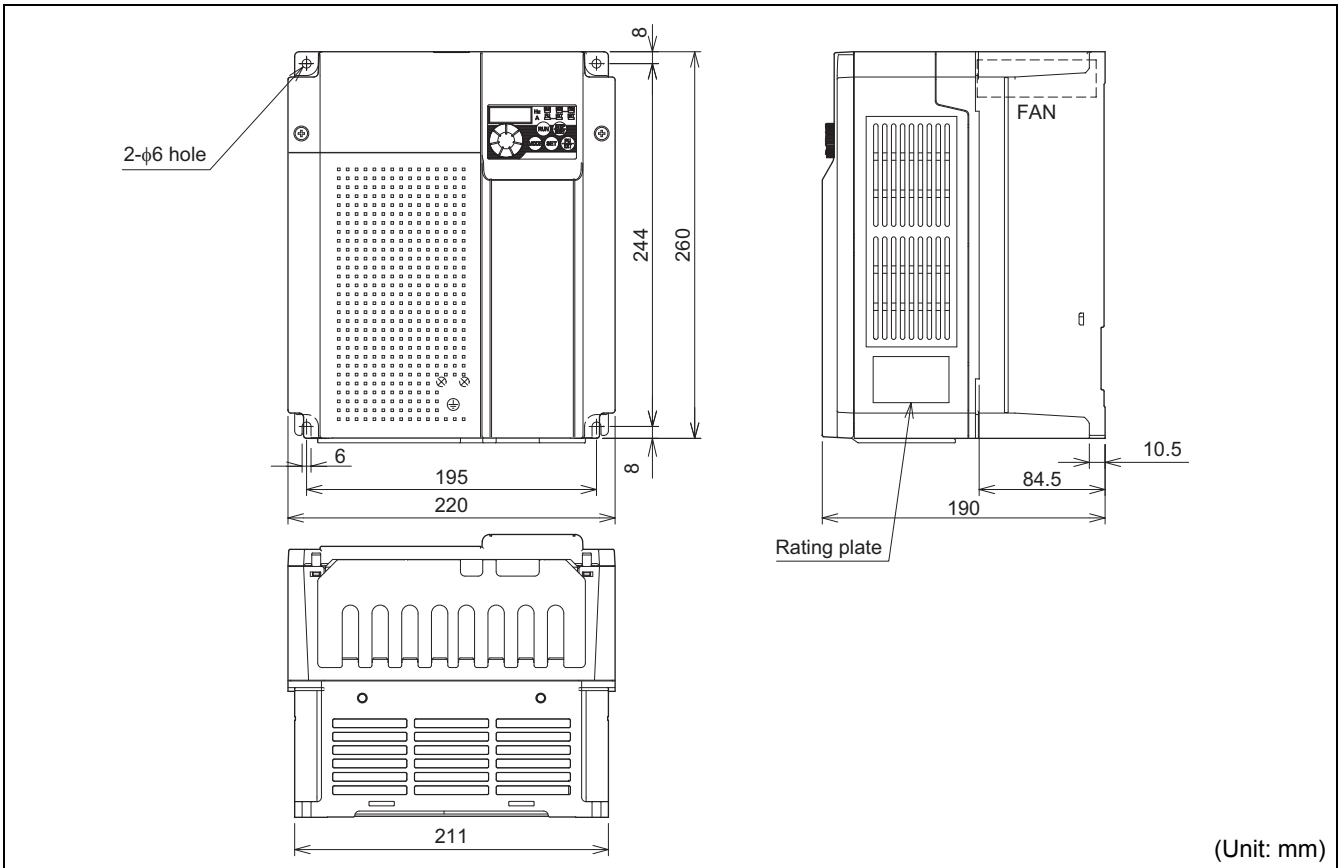

- Parameter unit (option) (FR-PU07)

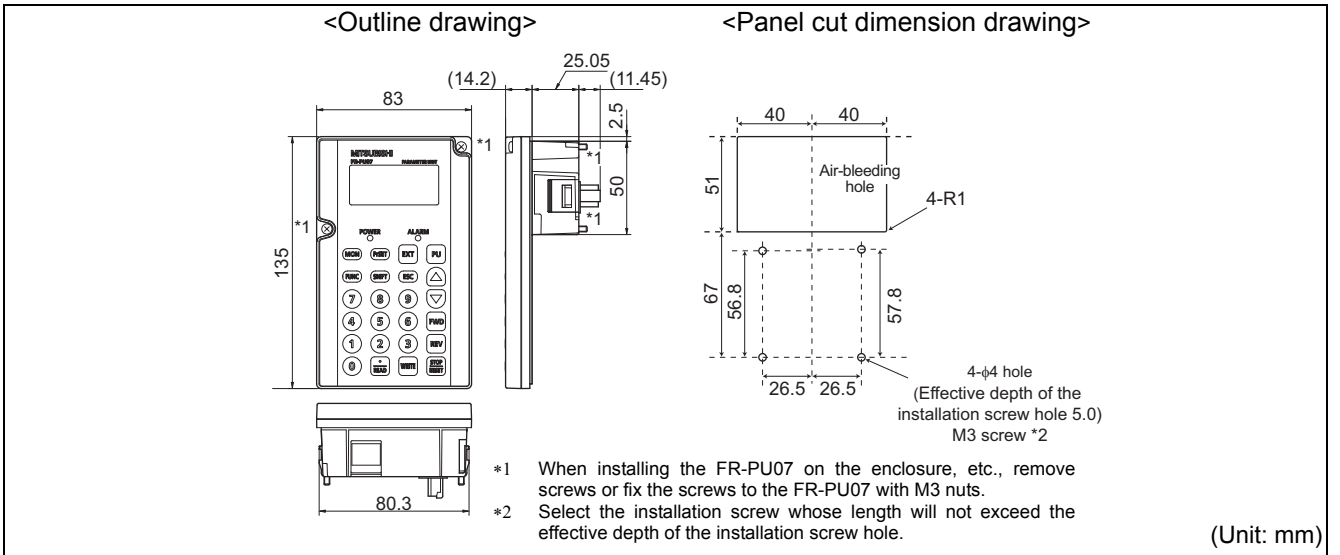

- Enclosure surface operation panel (option) (FR-PA07)

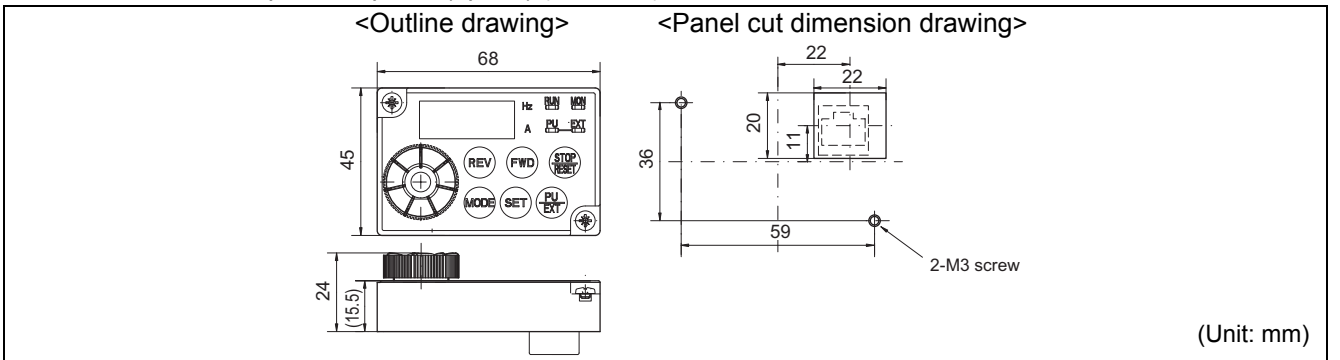

- Features
- Standard Specifications
- Outline Dimension Drawings
- Terminal Connection Diagram Terminal Specification Explanation
- Operation panel Parameter unit
- Parameter List
- Protective Functions
- Options
- Instructions
- FR-D700 Series Specification Difference List
- Warranty International FA Center

Terminal Connection Diagram

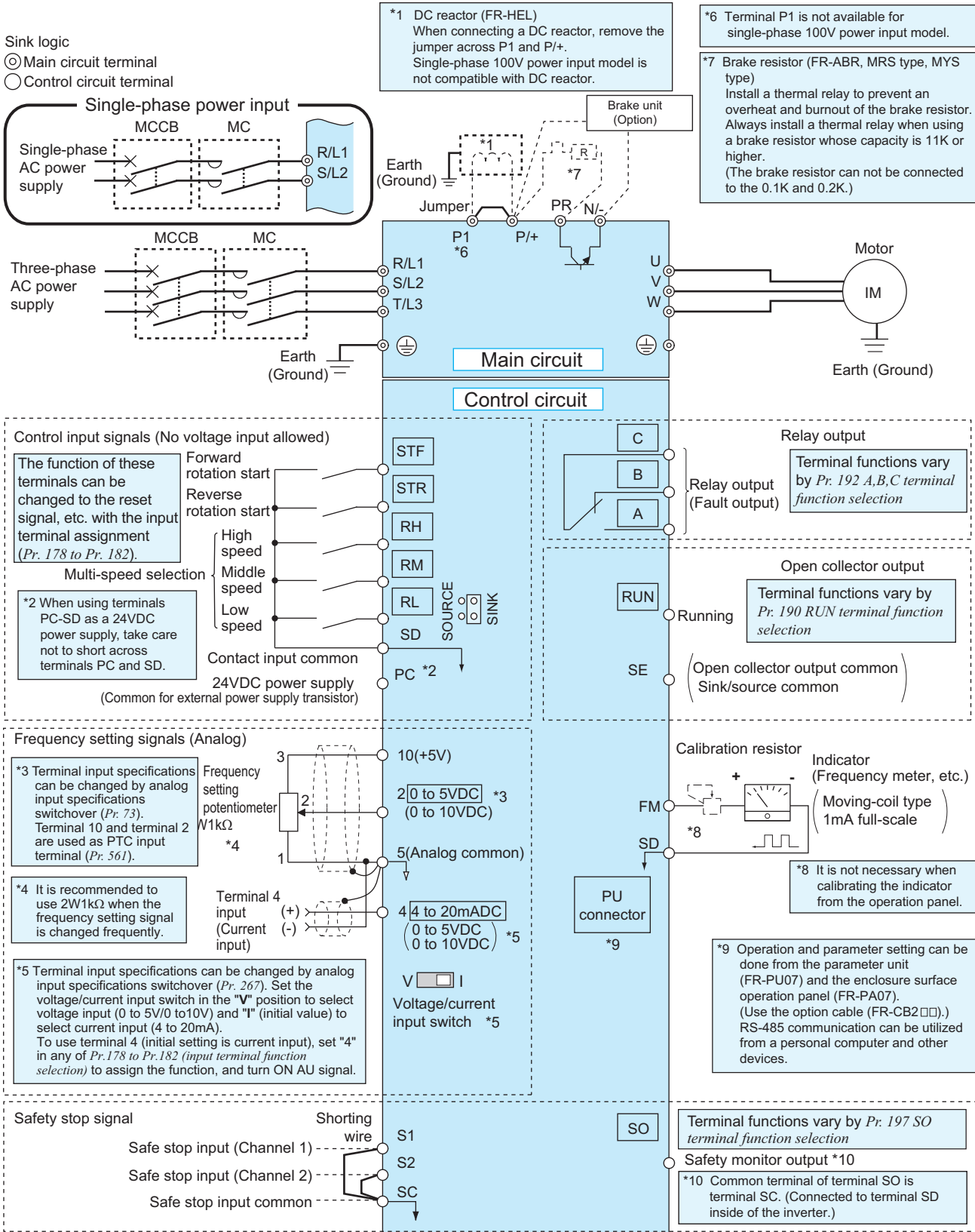

Note

- To prevent a malfunction caused by noise, separate the signal cables more than 10cm from the power cables. Also separate the main circuit wire of the input side and the output side.
- After wiring, wire offcuts must not be left in the inverter. Wire offcuts can cause an alarm, failure or malfunction. Always keep the inverter clean. When drilling mounting holes in an enclosure etc., take care not to allow chips and other foreign matter to enter the inverter.
- The output of the single-phase power input specification is three-phase 200V.

Terminal Specification Explanation

Type	Terminal Symbol	Terminal Name	Description		
Main circuit	R/L1, S/L2, T/L3 *	AC power input	Connect to the commercial power supply. Keep these terminals open when using the high power factor converter (FR-HC2) or power regeneration common converter (FR-CV). * When using single-phase power input, terminals are R/L1 and S/L2.		
	U, V, W	Inverter output	Connect a three-phase squirrel-cage motor.		
	P/+, PR	Brake resistor connection	Connect a brake resistor (FR-ABR, MRS type, MYS type) across terminals P/+ and PR. (The brake resistor can not be connected to the 0.1K and 0.2K.)		
	P/+, N/-	Brake unit connection	Connect the brake unit (FR-BU2), power regeneration common converter (FR-CV) or high power factor converter (FR-HC2).		
	P/+, P1 *	DC reactor connection	Remove the jumper across terminals P/+-P1 and connect a DC reactor. Single-phase 100V power input model is not compatible with DC reactor. * Terminal P1 is not available for single-phase 100V power input model.		
		Earth (Ground)	For earthing (grounding) the inverter chassis. Must be earthed (grounded).		
Control circuit/input signal	Contact input	STF	Forward rotation start	Turn on the STF signal to start forward rotation and turn it off to stop. When the STF and STR signals are turned on simultaneously, the stop command is given.	
		STR	Reverse rotation start	Turn on the STR signal to start reverse rotation and turn it off to stop.	
		RH, RM, RL	Multi-speed selection	Multi-speed can be selected according to the combination of RH, RM and RL signals.	
		SD	Contact input common (sink) (initial setting)	Common terminal for contact input terminal (sink logic) and terminal FM.	
			External transistor common (source)	When connecting the transistor output (open collector output), such as a programmable controller, when source logic is selected, connect the external power supply common for transistor output to this terminal to prevent a malfunction caused by undesirable currents.	
	24VDC power supply common		Common output terminal for 24VDC 0.1A power supply (PC terminal). Isolated from terminals 5 and SE.		
	PC	External transistor common (sink) (initial setting)	When connecting the transistor output (open collector output), such as a programmable controller, when sink logic is selected, connect the external power supply common for transistor output to this terminal to prevent a malfunction caused by undesirable currents.		
		Contact input common (source)	Common terminal for contact input terminal (source logic).		
		24VDC power supply	Can be used as 24VDC 0.1A power supply.		
	Frequency setting	10	Frequency setting power supply	Used as power supply when connecting potentiometer for frequency setting (speed setting) from outside of the inverter. 5VDC permissible load current 10mA	
			2	Frequency setting (voltage)	Inputting 0 to 5VDC (or 0 to 10V) provides the maximum output frequency at 5V (10V) and makes input and output proportional. Use Pr. 73 to switch between input 0 to 5VDC (initial setting) and 0 to 10VDC input. Input resistance 10kΩ ± 1kΩ Permissible maximum voltage 20VDC
		4	Frequency setting (current)	Inputting 4 to 20mADC (or 0 to 5V, 0 to 10V) provides the maximum output frequency at 20mA and makes input and output proportional. This input signal is valid only when the AU signal is ON (terminal 2 input is invalid). To use terminal 4 (initial setting is current input), set "4" in any of Pr.178 to Pr.182 (input terminal function selection) to assign the function, and turn ON AU signal. Use Pr. 267 to switch from among input 4 to 20mA (initial setting), 0 to 5VDC and 0 to 10VDC. Set the voltage/current input switch in the "V" position to select voltage input (0 to 5V/0 to 10V). Voltage input: Input resistance 10kΩ ± 1kΩ Permissible maximum voltage 20VDC Current input: Input resistance 249Ω ± 5Ω Maximum permissible current 30mA.	
			5	Frequency setting common	Common terminal for the frequency setting signals (terminals 2 or 4). Do not earth (ground).
		PTC thermistor	10 2	PTC thermistor input	For connecting PTC thermistor output. When PTC thermistor protection is valid (Pr. 561 ≠ "9999"), terminal 2 is not available for frequency setting. Adaptive PTC thermistor specification Heat detection resistance : 500Ω to 30kΩ (Set by Pr. 561)
	Control circuit/output signal	Relay	A, B, C	Relay output (fault output)	1 changeover contact output indicates that the inverter fault occurs. Fault: discontinuity across B-C (continuity across A-C), Normal: continuity across B-C (discontinuity across A-C) Contact capacity 230VAC 0.3A (power factor = 0.4) 30VDC 0.3A
Open collector		RUN	Inverter running	Switched low when the inverter output frequency is equal to or higher than the starting frequency (initial value 0.5Hz). Switched high during stop or DC injection brake operation. (Low is when the open collector output transistor is ON (conducts). High is when the transistor is OFF (does not conduct).) Permissible load 24VDC (Maximum 27VDC) 0.1A (a voltage drop is 3.4V maximum when the signal is on)	
		SE	Open collector output common	Common terminal of terminal RUN and FU.	
Pulse		FM	For meter	Select one e.g. output frequency from monitor items. (Not output during inverter reset.) The output signal is proportional to the magnitude of the corresponding monitoring item. Permissible load current 1mA 1440 pulses/s at 60Hz	
Communication	—	PU connector	With the PU connector, RS-485 communication can be made. · Conforming standard: EIA-485 (RS-485) · Transmission format: Multi-drop link · Communication speed: 4800 to 38400bps · Overall extension: 500m		
Safety stop signal	S1	Safety stop input (Channel 1)	Terminals S1 and S2 are for safety stop input signals used with the safety relay module. Terminals S1 and S2 are used simultaneously (dual channel). Inverter output is shut off by shortening/opening across terminals S1 and SC and across S2 and SC. In the initial status, terminals S1 and S2 are shorted with terminal SC by shortening wire. Remove the shortening wire and connect the safety relay module when using the safety stop function.		
		S2			Safety stop input (Channel 2)
	SO	Safety monitor output (open collector output)	The signal indicates the status of safety stop input. Low indicates safe state, and High indicates drive enabled or fault detected. (Low is when the open collector output transistor is ON (conducts). High is when the transistor is OFF (does not conduct).) Permissible load 24VDC (Maximum 27VDC) 0.1A (a voltage drop is 3.4V maximum when the signal is on)		
	SC	Safety stop input terminal common	Common terminal for terminals S1, S2 and SO. Connected to terminal SD inside of the inverter.		



Note

- Set Pr. 267 and a voltage/current input switch correctly, then input an analog signal in accordance with the setting. Applying a voltage with voltage/current input switch in "I" position (current input is selected) or a current with switch in "V" position (voltage input is selected) could cause component damage of the inverter or analog circuit of output devices.
- The inverter will be damaged if power is applied to the inverter output terminals (U, V, W). Never perform such wiring.
- indicates that terminal functions can be selected using Pr. 178 to Pr. 182, Pr. 190, Pr. 192, Pr. 197 (I/O terminal function selection).
- Terminal names and terminal functions are those of the factory set.

- Features
- Standard Specifications
- Outline Dimension Drawings
- Terminal Connection Diagram Terminal Specification Explanation
- Operation panel Parameter unit
- Parameter List
- Protective Functions
- Options
- Instructions
- FR-D700 Series Specification Difference List
- Warranty International FA Center

Explanation of the Operation Panel

The operation panel cannot be removed from the inverter.

Operation mode indicator
 PU: Lit to indicate PU operation mode.
 EXT: Lit to indicate External operation mode.
 (Lit at power-ON at initial setting.)
 NET: Lit to indicate Network operation mode.
 PU, EXT: Lit to indicate External/PU
 combined operation mode 1, 2.
 These turn OFF when command source is
 not on operation panel.

Unit indicator
 Hz: Lit to indicate frequency.
 (Flickers when the set frequency
 monitor is displayed.)
 A: Lit to indicate current.
 (Both "Hz" and "A" turn OFF when other
 than the above is displayed.)

Monitor (4-digit LED)
 Shows the frequency, parameter number,
 etc.

Setting dial
 (Setting dial: Mitsubishi inverter dial)
 Used to change the frequency setting
 and parameter settings.
 Press to display the following.
 • Displays the set frequency in the
 monitor mode
 • Present set value is displayed during
 calibration
 • Displays the order in the faults history
 mode

Mode switchover
 Used to change each setting mode.
 Pressing $\frac{PU}{EXT}$ simultaneously changes
 the operation mode.
 Pressing for a while (2s) can lock
 operation.

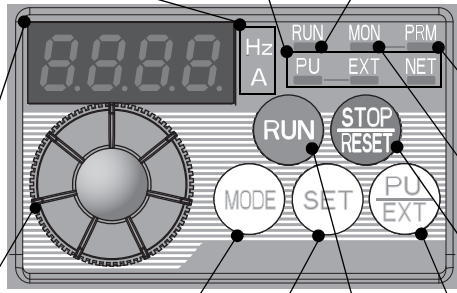
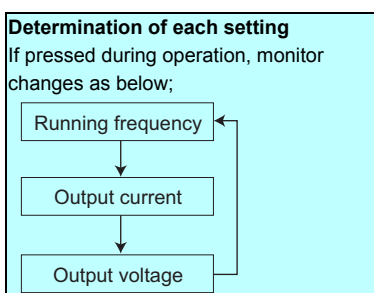

Operating status indicator
 Lit or flicker during inverter operation. *
 * Lit: When the forward rotation operation
 is being performed.
 Slow flickering (1.4s cycle):
 When the reverse rotation operation
 is being performed.
 Fast flickering (0.2s cycle):
 When RUN was pressed or the
 start command was given, but the
 operation cannot be made.
 •When the frequency command is less
 than the starting frequency.
 •When the MRS signal is input.

Parameter setting mode indicator
 Lit to indicate parameter setting mode.

Monitor indicator
 Lit to indicate monitoring mode.

Stop operation
 Used to stop Run command.
 Fault can be reset when protective
 function is activated (fault).

Operation mode switchover
 Used to switch between the PU and
 External operation mode.
 When using the External operation mode
 (operation using a separately connected
 frequency setting potentiometer and start
 signal), press this key to light up the EXT
 indication.
 (Press MODE simultaneously (0.5s) or
 change Pr: 79 setting to change to combined
 mode.)
 PU: PU operation mode
 EXT: External operation mode
 Cancels PU stop also.

Start command
 The rotation direction can be selected by
 setting Pr: 40.

Basic operation of the operation panel

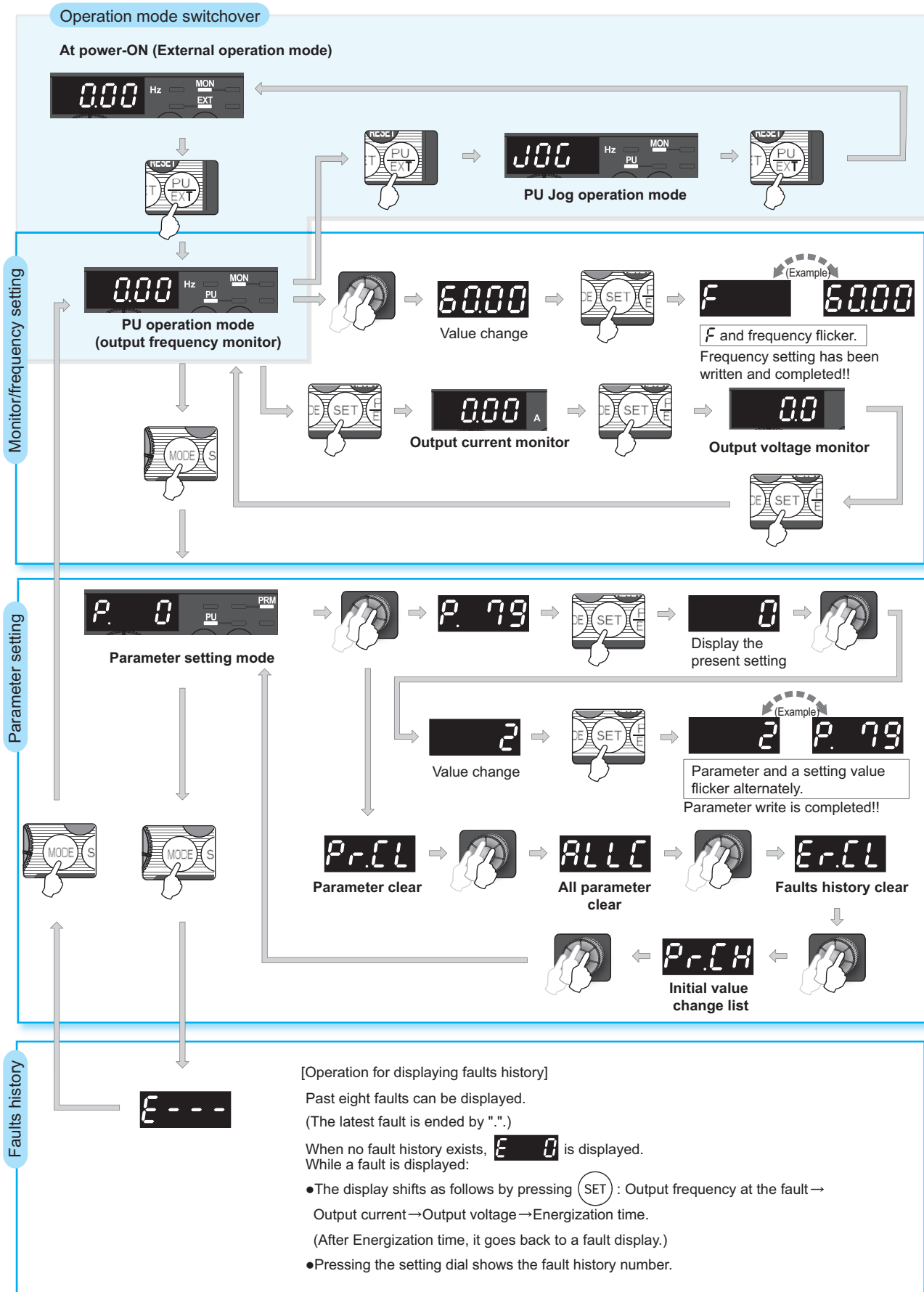

Features

Standard Specifications

Outline Dimension Drawings

Terminal Connection Diagram Terminal Specification Explanation

Operation panel Parameter unit

Parameter List

Protective Functions

Options

Instructions

FR-D700 Series Specification Difference List

Warranty International FA Center

Explanations of Parameter unit

Parameter unit (FR-PU07)

- The parameter unit is a convenient tool for inverter setting such as direct input method with a numeric keypad, operation status indication, and help function.
- Eight languages can be displayed.
- Parameter setting values of maximum of three inverters can be stored.
- * The parameter unit connection cable FR-CB20□ is required for connecting to the inverter.

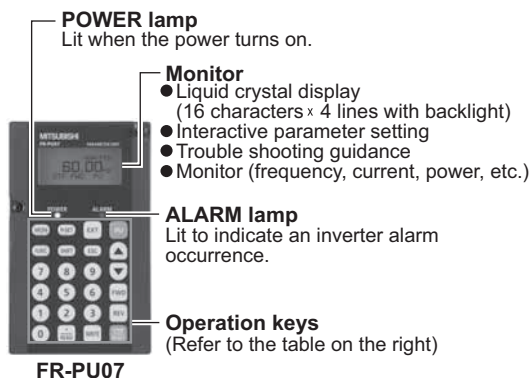

Key	Description
PrSET	Use for parameter setting Press to choose the parameter setting mode.
MON	First priority monitor is displayed. In the initial setting, the output frequency is displayed.
ESC	Operation cancel key
FUNC	Used to display the function menu. A variety of functions can be used on the function menu.
SHIFT	Used to shift to the next item in the setting or monitoring mode.
0 to 9	Used to enter a frequency, parameter number or set value.
EXT	Inverter operates in the External operation mode.
PU	Used to select the PU operation mode to display the frequency setting screen.
▲ ▼	<ul style="list-style-type: none"> • Used to keep on increasing or decreasing the running frequency. Hold down to vary the frequency. • Press either of these keys on the parameter setting mode screen to change the parameter setting value sequentially. • On the selecting screen, these keys are used to move the cursor.
FWD	Forward rotation command key.
REV	Reverse rotation command key.
STOP RESET	<ul style="list-style-type: none"> • Stop command key. • Used to reset the inverter when an alarm occurs.
WRITE	<ul style="list-style-type: none"> • Used to write a set value in the setting mode. • Used as a clear key in the all parameter clear or alarm history clear mode.
• READ	<ul style="list-style-type: none"> • Used as a decimal point when entering numerical value. • The monitor screen selected by the cursor appears.

• Main functions

Function	Description
Monitor	6 types of monitors appear by simply pressing SHIFT .
Frequency setting	For PU operation mode and External/PU combined operation mode (<i>Pr:79</i> = "3"), frequency setting is available. Settings is performed by the direct setting, which sets frequency directly by 0 to 9 , and the step setting, which sets frequency continuously by ▲ ▼ .
Parameter Setting	Reading parameter and changing setting values are easily done. To change the setting value of an parameter, specify the parameter number, or select a parameter from the functional parameter list.
Batch copy	FR-PU07 reads parameter settings of an inverter, and stores three different parameter settings. FR-PU07 can also copy the stored parameter setting to another inverter of the same series, or verify its stored parameter setting against the parameter setting stored in an inverter.
Operation	Switching between External operation mode [EXT] and PU operation mode [PU] is easy. Start/stop is enabled during PU operation mode and External/PU operation mode (<i>Pr:79</i> = "3").

* Available function differs by the inverter. Please refer to the instruction manual of the inverter and the parameter unit.

Parameter List

For simple variable-speed operation of the inverter, the initial setting of the parameters may be used as they are. Set the necessary parameters to meet the load and operational specifications. Parameter setting, change and check can be made from the operation panel. For details of parameters, refer to the Instruction Manual.

This catalog explains based on the Japanese specifications.



POINT

Only simple mode parameters are displayed by the initial setting of Pr. 160 Extended function display selection. Set Pr. 160 Extended function display selection as required.

Pr. 160	Description
9999 (initial value)	Parameters classified as simple mode can be displayed.
0	Both the parameters classified as simple mode and the parameters classified as extended mode can be displayed.

Parameter Number	Name	Unit	Initial Value	Range	Application
0	Torque boost	0.1%	6%/4%/3/ 2%*	0 to 30%	Set when you want to increase a starting torque under V/F control, or when the motor with a load will not rotate, resulting in an alarm [OL] and a trip [OC1]. * Initial values differ according to the inverter capacity. (0.75K or less/ 1.5K to 3.7K/5.5K, 7.5K/11K, 15K)
1	Maximum frequency	0.01Hz	120Hz	0 to 120Hz	Set when the maximum output frequency need to be limited.
2	Minimum frequency	0.01Hz	0Hz	0 to 120Hz	Set when the minimum output frequency need to be limited.
3	Base frequency	0.01Hz	60Hz	0 to 400Hz	Set when the rated motor frequency is 50Hz. Check the motor rating plate.
4	Multi-speed setting (high speed)	0.01Hz	60Hz	0 to 400Hz	Set when changing the preset speed in the parameter with a terminal.
5	Multi-speed setting (middle speed)	0.01Hz	30Hz	0 to 400Hz	
6	Multi-speed setting (low speed)	0.01Hz	10Hz	0 to 400Hz	
7	Acceleration time	0.1s	5s/10s/15s*	0 to 3600s	Acceleration/deceleration time can be set. * Initial values differ according to the inverter capacity. (3.7K or less/ 5.5K, 7.5K/11K, 15K)
8	Deceleration time	0.1s	5s/10s/15s*	0 to 3600s	
9	Electronic thermal O/L relay	0.01A	Rated inverter current	0 to 500A	The inverter protects the motor from overheat. Set the rated motor current.
79	Operation mode selection	1	0	0, 1, 2, 3, 4, 6, 7	Select the start command location and frequency setting location.
125	Terminal 2 frequency setting gain frequency	0.01Hz	60Hz	0 to 400Hz	Frequency for the maximum value of the potentiometer (5V initial value) can be changed.
126	Terminal 4 frequency setting gain frequency	0.01Hz	60Hz	0 to 400Hz	Frequency for the maximum current input (20mA initial value) can be changed.
160	Extended function display selection	1	9999	0, 9999	Parameter which can be read from the operation panel and parameter unit (FR-PU07) can be restricted.

Features

Standard Specifications

Outline Dimension Drawings

Terminal Connection Diagram Terminal Specification Explanation

Operation panel Parameter unit

Parameter List

Protective Functions

Options

Instructions

FR-D700 Series Specification Difference List

Warranty International FA Center

● Extended mode parameter



REMARKS

- ◎ indicates simple mode parameters.
- The shaded parameters in the table allow its setting to be changed during operation even if "0" (initial value) is set in Pr. 77 Parameter write selection.

Function	Parameter	Name	Setting Range	Minimum Setting Increments	Initial Value	Customer Setting
Basic functions	◎ 0	Torque boost	0 to 30%	0.1%	6/4/3/2% *1	
	◎ 1	Maximum frequency	0 to 120Hz	0.01Hz	120Hz	
	◎ 2	Minimum frequency	0 to 120Hz	0.01Hz	0Hz	
	◎ 3	Base frequency	0 to 400Hz	0.01Hz	60Hz	
	◎ 4	Multi-speed setting (high speed)	0 to 400Hz	0.01Hz	60Hz	
	◎ 5	Multi-speed setting (middle speed)	0 to 400Hz	0.01Hz	30Hz	
	◎ 6	Multi-speed setting (low speed)	0 to 400Hz	0.01Hz	10Hz	
	◎ 7	Acceleration time	0 to 3600s	0.1s	5/10/15s *2	
	◎ 8	Deceleration time	0 to 3600s	0.1s	5/10/15s *2	
DC injection brake	◎ 9	Electronic thermal O/L relay	0 to 500A	0.01A	Rated inverter current	
	10	DC injection brake operation frequency	0 to 120Hz	0.01Hz	3Hz	
	11	DC injection brake operation time	0 to 10s	0.1s	0.5s	
—	12	DC injection brake operation voltage	0 to 30%	0.1%	6/4/2% *3	
	13	Starting frequency	0 to 60Hz	0.01Hz	0.5Hz	
—	14	Load pattern selection	0 to 3	1	0	
JOG operation	15	Jog frequency	0 to 400Hz	0.01Hz	5Hz	
	16	Jog acceleration/deceleration time	0 to 3600s	0.1s	0.5s	
—	17	MRS input selection	0, 2, 4	1	0	
—	18	High speed maximum frequency	120 to 400Hz	0.01Hz	120Hz	
—	19	Base frequency voltage	0 to 1000V, 8888, 9999	0.1V	9999	
Acceleration/ deceleration time	20	Acceleration/deceleration reference frequency	1 to 400Hz	0.01Hz	60Hz	
Stall prevention	22	Stall prevention operation level	0 to 200%	0.1%	150%	
	23	Stall prevention operation level compensation factor at double speed	0 to 200%, 9999	0.1%	9999	
Multi-speed setting	24	Multi-speed setting (speed 4)	0 to 400Hz, 9999	0.01Hz	9999	
	25	Multi-speed setting (speed 5)	0 to 400Hz, 9999	0.01Hz	9999	
	26	Multi-speed setting (speed 6)	0 to 400Hz, 9999	0.01Hz	9999	
	27	Multi-speed setting (speed 7)	0 to 400Hz, 9999	0.01Hz	9999	
—	29	Acceleration/deceleration pattern selection	0, 1, 2	1	0	
—	30	Regenerative function selection	0, 1, 2	1	0	
Frequency jump	31	Frequency jump 1A	0 to 400Hz, 9999	0.01Hz	9999	
	32	Frequency jump 1B	0 to 400Hz, 9999	0.01Hz	9999	
	33	Frequency jump 2A	0 to 400Hz, 9999	0.01Hz	9999	
	34	Frequency jump 2B	0 to 400Hz, 9999	0.01Hz	9999	
	35	Frequency jump 3A	0 to 400Hz, 9999	0.01Hz	9999	
	36	Frequency jump 3B	0 to 400Hz, 9999	0.01Hz	9999	
—	37	Speed display	0, 0.01 to 9998	0.001	0	
—	40	RUN key rotation direction selection	0, 1	1	0	
Frequency detection	41	Up-to-frequency sensitivity	0 to 100%	0.1%	10%	
	42	Output frequency detection	0 to 400Hz	0.01Hz	6Hz	
	43	Output frequency detection for reverse rotation	0 to 400Hz, 9999	0.01Hz	9999	

Function	Parameter	Name	Setting Range	Minimum Setting Increments	Initial Value	Customer Setting
Second functions	44	Second acceleration/deceleration time	0 to 3600s	0.1s	5/10/15s *2	
	45	Second deceleration time	0 to 3600s, 9999	0.1s	9999	
	46	Second torque boost	0 to 30%, 9999	0.1%	9999	
	47	Second V/F (base frequency)	0 to 400Hz, 9999	0.01Hz	9999	
	48	Second stall prevention operation current	0 to 200%, 9999	0.1%	9999	
	51	Second electronic thermal O/L relay	0 to 500A, 9999	0.01A	9999	
Monitor functions	52	DU/PU main display data selection	0, 5, 8 to 12, 14, 20, 23 to 25, 52 to 55, 61, 62, 64, 100	1	0	
	54	FM terminal function selection	1 to 3, 5, 8 to 12, 14, 21, 24, 52, 53, 61, 62	1	1	
	55	Frequency monitoring reference	0 to 400Hz	0.01Hz	60Hz	
	56	Current monitoring reference	0 to 500A	0.01A	Rated inverter current	
Automatic restart functions	57	Restart coasting time	0, 0.1 to 5s, 9999	0.1s	9999	
	58	Restart cushion time	0 to 60s	0.1s	1s	
—	59	Remote function selection	0, 1, 2, 3	1	0	
—	60	Energy saving control selection	0, 9	1	0	
—	65	Retry selection	0 to 5	1	0	
—	66	Stall prevention operation reduction starting frequency	0 to 400Hz	0.01Hz	60Hz	
Retry	67	Number of retries at fault occurrence	0 to 10, 101 to 110	1	0	
	68	Retry waiting time	0.1 to 600s	0.1s	1s	
	69	Retry count display erase	0	1	0	
—	70	Special regenerative brake duty	0 to 30%	0.1%	0%	
—	71	Applied motor	0, 1, 3, 13, 23, 40, 43, 50, 53	1	0	
—	72	PWM frequency selection	0 to 15	1	1	
—	73	Analog input selection	0, 1, 10, 11	1	1	
—	74	Input filter time constant	0 to 8	1	1	
—	75	Reset selection/disconnected PU detection/PU stop selection	0 to 3, 14 to 17	1	14	
—	77	Parameter write selection	0, 1, 2	1	0	
—	78	Reverse rotation prevention selection	0, 1, 2	1	0	
—	© 79	Operation mode selection	0, 1, 2, 3, 4, 6, 7	1	0	
Motor constants	80	Motor capacity	0.1 to 15kW, 9999	0.01kW	9999	
	82	Motor excitation current	0 to 500A, 9999	0.01A	9999	
	83	Rated motor voltage	0 to 1000V	0.1V	200V/400V *4	
	84	Rated motor frequency	10 to 120Hz	0.01Hz	60Hz	
	90	Motor constant (R1)	0 to 50Ω , 9999	0.001Ω	9999	
	96	Auto tuning setting/status	0, 11, 21	1	0	
PU connector communication	117	PU communication station number	0 to 31 (0 to 247)	1	0	
	118	PU communication speed	48, 96, 192, 384	1	192	
	119	PU communication stop bit length	0, 1, 10, 11	1	1	
	120	PU communication parity check	0, 1, 2	1	2	
	121	Number of PU communication retries	0 to 10, 9999	1	1	
	122	PU communication check time interval	0, 0.1 to 999.8s, 9999	0.1s	0	
	123	PU communication waiting time setting	0 to 150ms, 9999	1ms	9999	
	124	PU communication CR/LF selection	0, 1, 2	1	1	
—	© 125	Terminal 2 frequency setting gain frequency	0 to 400Hz	0.01Hz	60Hz	
—	© 126	Terminal 4 frequency setting gain frequency	0 to 400Hz	0.01Hz	60Hz	

Features

Standard Specifications

Outline Dimension Drawings

Terminal Connection Diagram Terminal Specification Explanation

Operation panel Parameter unit

Parameter List

Protective Functions

Options

Instructions

FR-D700 Series Specification Difference List

Warranty International FA Center

Function	Parameter	Name	Setting Range	Minimum Setting Increments	Initial Value	Customer Setting
PID operation	127	PID control automatic switchover frequency	0 to 400Hz, 9999	0.01Hz	9999	
	128	PID action selection	0, 20, 21, 40 to 43	1	0	
	129	PID proportional band	0.1 to 1000%, 9999	0.1%	100%	
	130	PID integral time	0.1 to 3600s, 9999	0.1s	1s	
	131	PID upper limit	0 to 100%, 9999	0.1%	9999	
	132	PID lower limit	0 to 100%, 9999	0.1%	9999	
	133	PID action set point	0 to 100%, 9999	0.01%	9999	
	134	PID differential time	0.01 to 10s, 9999	0.01s	9999	
PU	145	PU display language selection	0 to 7	1	0	
—	146 *5	Built-in potentiometer switching	0, 1	1	1	
Current detection	150	Output current detection level	0 to 200%	0.1%	150%	
	151	Output current detection signal delay time	0 to 10s	0.1s	0s	
	152	Zero current detection level	0 to 200%	0.1%	5%	
	153	Zero current detection time	0 to 1s	0.01s	0.5s	
	—	154	Voltage reduction selection during stall prevention operation	1, 11	1	1
—	156	Stall prevention operation selection	0 to 31, 100, 101	1	0	
—	157	OL signal output timer	0 to 25s, 9999	0.1s	0s	
—	⊙ 160	Extended function display selection	0, 9999	1	9999	
—	161	Frequency setting/key lock operation selection	0, 1, 10, 11	1	0	
Automatic restart functions	162	Automatic restart after instantaneous power failure selection	0, 1, 10, 11	1	1	
	165	Stall prevention operation level for restart	0 to 200%	0.1%	150%	
Current detection	166	Output current detection signal retention time	0 to 10s, 9999	0.1s	0.1s	
	167	Output current detection operation selection	0, 1	1	0	
—	168	Parameter for manufacturer setting. Do not set.				
—	169	Parameter for manufacturer setting. Do not set.				
Cumulative monitor clear	170	Watt-hour meter clear	0, 10, 9999	1	9999	
	171	Operation hour meter clear	0, 9999	1	9999	
Input terminal function assignment	178	STF terminal function selection	0 to 5, 7, 8, 10, 12, 14, 16, 18, 24, 25, 60, 62, 65 to 67, 9999	1	60	
	179	STR terminal function selection	0 to 5, 7, 8, 10, 12, 14, 16, 18, 24, 25, 61, 62, 65 to 67, 9999	1	61	
	180	RL terminal function selection	0 to 5, 7, 8, 10, 12, 14, 16, 18, 24, 25, 62, 65 to 67, 9999	1	0	
	181	RM terminal function selection		1	1	
	182	RH terminal function selection		1	2	

Function	Parameter	Name	Setting Range	Minimum Setting Increments	Initial Value	Customer Setting
Output terminal function assignment	190	RUN terminal function selection	0, 1, 3, 4, 7, 8, 11 to 16, 25, 26, 46, 47, 64, 70, 80, 81, 90, 91, 93, 95, 96, 98, 99, 100, 101, 103, 104, 107, 108, 111 to 116, 125, 126, 146, 147, 164, 170, 180, 181, 190, 191, 193, 195, 196, 198, 199, 9999	1	0	
	192	A,B,C terminal function selection	0, 1, 3, 4, 7, 8, 11 to 16, 25, 26, 46, 47, 64, 70, 80, 81, 90, 91, 95, 96, 98, 99, 100, 101, 103, 104, 107, 108, 111 to 116, 125, 126, 146, 147, 164, 170, 180, 181, 190, 191, 195, 196, 198, 199, 9999	1	99	
	197	SO terminal function selection	0, 1, 3, 4, 7, 8, 11 to 16, 25, 26, 46, 47, 64, 70, 80, 81, 90, 91, 93, 95, 96, 98, 99, 100, 101, 103, 104, 107, 108, 111 to 116, 125, 126, 146, 147, 164, 170, 180, 181, 190, 191, 193, 195, 196, 198, 199	1	80	
Multi-speed setting	232	Multi-speed setting (speed 8)	0 to 400Hz, 9999	0.01Hz	9999	
	233	Multi-speed setting (speed 9)	0 to 400Hz, 9999	0.01Hz	9999	
	234	Multi-speed setting (speed 10)	0 to 400Hz, 9999	0.01Hz	9999	
	235	Multi-speed setting (speed 11)	0 to 400Hz, 9999	0.01Hz	9999	
	236	Multi-speed setting (speed 12)	0 to 400Hz, 9999	0.01Hz	9999	
	237	Multi-speed setting (speed 13)	0 to 400Hz, 9999	0.01Hz	9999	
	238	Multi-speed setting (speed 14)	0 to 400Hz, 9999	0.01Hz	9999	
	239	Multi-speed setting (speed 15)	0 to 400Hz, 9999	0.01Hz	9999	
—	240	Soft-PWM operation selection	0, 1	1	1	
—	241	Analog input display unit switchover	0, 1	1	0	
—	244	Cooling fan operation selection	0, 1	1	1	
Slip compensation	245	Rated slip	0 to 50%, 9999	0.01%	9999	
	246	Slip compensation time constant	0.01 to 10s	0.01s	0.5s	
	247	Constant-power range slip compensation selection	0, 9999	1	9999	
—	249	Earth (ground) fault detection at start	0, 1	1	0	
—	250	Stop selection	0 to 100s, 1000 to 1100s, 8888, 9999	0.1s	9999	
—	251	Output phase loss protection selection	0, 1	1	1	
Life diagnosis	255	Life alarm status display	(0 to 15)	1	0	
	256	Inrush current limit circuit life display	(0 to 100%)	1%	100%	
	257	Control circuit capacitor life display	(0 to 100%)	1%	100%	
	258	Main circuit capacitor life display	(0 to 100%)	1%	100%	
	259	Main circuit capacitor life measuring	0, 1 (2, 3, 8, 9)	1	0	
—	260	PWM frequency automatic switchover	0, 1	1	0	
Power failure stop	261	Power failure stop selection	0, 1, 2	1	0	
	—	267	Terminal 4 input selection	0, 1, 2	1	0
—	268	Monitor decimal digits selection	0, 1, 9999	1	9999	
—	269	Parameter for manufacturer setting. Do not set.				
—	295	Magnitude of frequency change setting	0, 0.01, 0.10, 1.00, 10.00	0.01	0	
Password function	296	Password lock level	1 to 6, 101 to 106, 9999	1	9999	
	297	Password lock/unlock	1000 to 9998 (0 to 5, 9999)	1	9999	
—	298	Frequency search gain	0 to 32767, 9999	1	9999	

- Features
- Standard Specifications
- Outline Dimension Drawings
- Terminal Connection Diagram Terminal Specification Explanation
- Operation panel Parameter unit
- Parameter List
- Protective Functions
- Options
- Instructions
- FR-D700 Series Specification Difference List
- Warranty International FA Center

Function	Parameter	Name	Setting Range	Minimum Setting Increments	Initial Value	Customer Setting
—	299	Rotation direction detection selection at restarting	0, 1, 9999	1	0	
RS-485 communication	338	Communication operation command source	0, 1	1	0	
	339	Communication speed command source	0, 1, 2	1	0	
	340	Communication startup mode selection	0, 1, 10	1	0	
	342	Communication EEPROM write selection	0, 1	1	0	
	343	Communication error count	—	1	0	
Second motor constant	450	Second applied motor	0, 1, 9999	1	9999	
Remote Output	495	Remote output selection	0, 1, 10, 11	1	0	
	496	Remote output data 1	0 to 4095	1	0	
—	502	Stop mode selection at communication error	0, 1, 2	1	0	
Maintenance	503	Maintenance timer	0 (1 to 9998)	1	0	
	504	Maintenance timer alarm output set time	0 to 9998, 9999	1	9999	
Communication	549	Protocol selection	0, 1	1	0	
	551	PU mode operation command source selection	2, 4, 9999	1	9999	
—	552	Frequency jump range	0 to 30Hz, 9999	0.01Hz	9999	
Current average time monitor	555	Current average time	0.1 to 1s	0.1s	1s	
	556	Data output mask time	0 to 20s	0.1s	0s	
	557	Current average value monitor signal output reference current	0 to 500A	0.01A	Rated inverter current	
—	561	PTC thermistor protection level	0.5 to 30k Ω , 9999	0.01k Ω	9999	
—	563	Energization time carrying-over times	(0 to 65535)	1	0	
—	564	Operating time carrying-over times	(0 to 65535)	1	0	
—	571	Holding time at a start	0 to 10s, 9999	0.1s	9999	
PID operation	575	Output interruption detection time	0 to 3600s, 9999	0.1s	1s	
	576	Output interruption detection level	0 to 400Hz	0.01Hz	0Hz	
	577	Output interruption cancel level	900 to 1100%	0.1%	1000%	
—	611	Acceleration time at a restart	0 to 3600s, 9999	0.1s	9999	
—	653	Speed smoothing control	0 to 200%	0.1%	0%	
—	665	Regeneration avoidance frequency gain	0 to 200%	0.1%	100%	
Protective functions	872 ^{*7}	Input phase loss protection selection	0, 1	1	0	
Regeneration avoidance function	882	Regeneration avoidance operation selection	0, 1, 2	1	0	
	883	Regeneration avoidance operation level	300 to 800V	0.1V	400VDC/ 780VDC ^{*4}	
	885	Regeneration avoidance compensation frequency limit value	0 to 10Hz, 9999	0.01Hz	6Hz	
	886	Regeneration avoidance voltage gain	0 to 200%	0.1%	100%	

Function	Parameter	Name	Setting Range	Minimum Setting Increments	Initial Value	Customer Setting
Free parameter	888	Free parameter 1	0 to 9999	1	9999	
	889	Free parameter 2	0 to 9999	1	9999	
—	891	Cumulative power monitor digit shifted times	0 to 4, 9999	1	9999	
Calibration parameters	C0 (900) ^{*6}	FM terminal calibration	—	—	—	
	C2 (902) ^{*6}	Terminal 2 frequency setting bias frequency	0 to 400Hz	0.01Hz	0Hz	
	C3 (902) ^{*6}	Terminal 2 frequency setting bias	0 to 300%	0.1%	0%	
	125 (903) ^{*6}	Terminal 2 frequency setting gain frequency	0 to 400Hz	0.01Hz	60Hz	
	C4 (903) ^{*6}	Terminal 2 frequency setting gain	0 to 300%	0.1%	100%	
	C5 (904) ^{*6}	Terminal 4 frequency setting bias frequency	0 to 400Hz	0.01Hz	0Hz	
	C6 (904) ^{*6}	Terminal 4 frequency setting bias	0 to 300%	0.1%	20%	
	126 (905) ^{*6}	Terminal 4 frequency setting gain frequency	0 to 400Hz	0.01Hz	60Hz	
	C7 (905) ^{*6}	Terminal 4 frequency setting gain	0 to 300%	0.1%	100%	
	C22 (922) ^{*5*6}	Frequency setting voltage bias frequency (built-in potentiometer)	0 to 400Hz	0.01Hz	0Hz	
	C23 (922) ^{*5*6}	Frequency setting voltage bias (built-in potentiometer)	0 to 300%	0.1%	0%	
	C24 (923) ^{*5*6}	Frequency setting voltage gain frequency (built-in potentiometer)	0 to 400Hz	0.01Hz	60Hz	
	C25 (923) ^{*5*6}	Frequency setting voltage gain (built-in potentiometer)	0 to 300%	0.1%	100%	
PU	990	PU buzzer control	0, 1	1	1	
	991	PU contrast adjustment	0 to 63	1	58	
Clear parameters Initial value change list	Pr.CL	Parameter clear	0, 1	1	0	
	ALLC	All parameter clear	0, 1	1	0	
	Er.CL	Faults history clear	0, 1	1	0	
	Pr.CH	Initial value change list	—	—	—	

*1 Differ according to capacities.
6%: 0.75K or lower
4%: 1.5K to 3.7K
3%: 5.5K, 7.5K
2%: 11K, 15K

*2 Differ according to capacities.
5s: 3.7K or lower
10s: 5.5K, 7.5K
15s: 11K, 15K

*3 Differ according to capacities.
6%: 0.1K, 0.2K
4%: 0.4K to 7.5K
2%: 11K, 15K

*4 The initial value differs according to the voltage class. (100V class, 200V class / 400V class)

*5 Set this parameter when calibrating the operation panel built-in potentiometer for the FR-E500 series operation panel (PA02) connected with cable.

*6 The parameter number in parentheses is the one for use with the operation panel (PA02) for the FR-E500 series or parameter unit (FR-PU07).

*7 Available only for the three-phase power input model.

- Features
- Standard Specifications
- Outline Dimension Drawings
- Terminal Connection Diagram Terminal Specification Explanation
- Operation panel Parameter unit
- Parameter List
- Protective Functions
- Options
- Instructions
- FR-D700 Series Specification Difference List
- Warranty International FA Center

Protective Functions

When a fault occurs, the inverter trips and the PU display automatically changes to any of the following fault or alarm indications.

	Function Name	Description	Display
Error message *2	Operation panel lock	Appears when operation was tried during operation panel lock.	HOLD
	Password locked	Appears when a password restricted parameter is read/written.	LOCd
	Parameter write error	Appears when an error occurred during parameter writing.	Err 1 to Err 4
	Inverter reset	Appears when the RES signal is on.	Err.
Warnings *3	Stall prevention (overcurrent)	Appears during overcurrent stall prevention.	OL
	Stall prevention (overvoltage)	Appears during overvoltage stall prevention. Appears while the regeneration avoidance function is activated.	oL
	Regenerative brake pre-alarm *7	Appears if the regenerative brake duty reaches or exceeds 85% of the Pr. 70 Special regenerative brake duty value. If the regenerative brake duty reaches 100%, a regenerative overvoltage (E. OV_) occurs.	rb
	Electronic thermal relay function pre-alarm	Appears when the electronic thermal O/L relay has reached 85% of the specified value.	TH
	PU stop	Appears when  on the operation panel was pressed during external operation.	PS
	Maintenance signal output *7	Appears when the cumulative energization time has exceeded the maintenance output timer set value.	MF
	Undervoltage	Appears when the main circuit power became low voltage.	Uv
	Safety stop	Appears when safety stop function is activated (during output shutoff).	SR
Alarms *4	Fan alarm	Appears when the cooling fan remains stopped when operation is required or when the speed has decreased.	F _n
Fault *5	Overcurrent trip during acceleration	Appears when an overcurrent occurred during acceleration.	EOC 1
	Overcurrent trip during constant speed	Appears when an overcurrent occurred during constant speed operation.	EOC 2
	Overcurrent trip during deceleration or stop	Appears when an overcurrent occurred during deceleration and at a stop.	EOC 3
	Regenerative overvoltage trip during acceleration	Appears when an overvoltage occurred during acceleration.	EOv 1
	Regenerative overvoltage trip during constant speed	Appears when an overvoltage occurred during constant speed operation.	EOv 2
	Regenerative overvoltage trip during deceleration or stop	Appears when an overvoltage occurred during deceleration and at a stop.	EOv 3
	Inverter overload trip (electronic thermal O/L relay function)	Appears when the electronic thermal relay function for inverter element protection was activated.	EFHF
	Motor overload trip (electronic thermal O/L relay function) *1	Appears when the electronic thermal relay function for motor protection was activated.	EFHN
	Heatsink overheat	Appears when the heatsink overheated.	EFIn
	Input phase loss *7 *8*9	Appears if one of the three phases on the inverter input side opened. It may function if phase-to-phase voltage of the three-phase power input becomes largely unbalanced.	EILF
	Stall prevention stop	Appears when the output frequency drops to 1Hz as a result of deceleration due to the excess motor load.	EOLr
	Brake transistor alarm detection	This function stops the inverter output if an alarm occurs in the brake circuit, e.g. damaged brake transistors. In this case, the inverter must be powered off immediately.	E. bE
	Output side earth (ground) fault overcurrent at start *7	Appears when an earth (ground) fault occurred on the inverter's output side. (detects only at a start)	E. GF
	Output phase loss	If one of the three phases (U, V, W) on the inverter's output side (load side) is lost during inverter operation (except during DC injection brake operation and when output frequency is under 1Hz), inverter stops the output.	E. LF
	External thermal relay operation*6 *7	Appears when the external thermal relay connected to the OH signal was activated.	EOHF
	PTC thermistor operation *7	Appears when resistance of PTC thermistor connected between terminal 2 and terminal 10 is more than the value set in Pr. 561 PTC thermistor protection level.	EPFC
	Parameter storage device fault	Appears when operation of the element where parameters stored became abnormal. (control board)	E. PE
	PU disconnection	Appears when a communication error between the PU and inverter occurred, the communication interval exceeded the permissible time during the RS-485 communication with the PU connector, or communication errors exceeded the number of retries during the RS-485 communication.	EPUE
	Retry count excess *7	Appears when the operation was not restarted within the set number of retries.	ErEr
	CPU fault	Appears during the CPU and peripheral circuit errors occurred.	E. S / E.CPU
Output current detection value exceeded *7	Appears when output current exceeded the output current detection level set by the parameter.	E.CdO	
Inrush current limit circuit fault	Appears when the resistor of the inrush current limit circuit overheated.	EIOH	
Analog input fault	Appears if voltage(current) is input to terminal 4 when the setting in Pr.267 Terminal 4 input selection and the setting of voltage/current input switch are different.	EAI E	
Safety circuit fault	Appears when safety circuit is malfunctioning.	ESAF	

*1 Resetting the inverter initializes the internal cumulative heat value of the electronic thermal relay function.
 *2 The error message shows an operational error. The inverter output is not shut off.
 *3 Warnings are messages given before fault occur. The inverter output is not shut off.
 *4 Alarms warn the operator of failures with output signals. The inverter output is not shut off.
 *5 When faults occur, the protective functions are activated to inverter trip and output the fault signals.
 *6 The external thermal operates only when the OH signal is set in Pr. 178 to Pr. 182 (input terminal function selection).
 *7 This protective function does not function in the initial status.
 *8 Protective function activates when Pr.872 Input phase loss protection selection = "1".
 *9 This protective function is available with the three-phase power input specification model only.

Option and Peripheral Devices

Option list

By fitting the following options to the inverter, the inverter is provided with more functions.

Name	Model	Applications, Specifications, etc.	Applicable Inverter	
Stand-alone shared	Parameter unit (8 languages)	FR-PU07	Interactive parameter unit with LCD display	Shared among all models
	Enclosure surface operation panel	FR-PA07	This operation panel enables inverter operation and monitoring of frequency, etc. from the enclosure surface	Shared among all models
	Parameter unit connection cable	FR-CB20□	Cable for connection of operation panel or parameter unit □ indicates a cable length. (1m, 3m, 5m)	
	DIN rail attachment	FR-JDA01 to 03	Attachment for installation on DIN rail	Compatible with the 3.7K or less
	AC reactor	FR-HAL	For harmonic current reduction and inverter input power factor improvement	According to capacities
	DC reactor	FR-HEL		
	EMC Directive compliant noise filter	SF	EMC Directive (EN61800-3 C3) compliant noise filter	According to capacities
		FR-E5NF FR-S5NFSA		
	EMC compliant EMC filter installation attachment	FR-A5AT03 FR-AAT02 FR-E5T	For installation of the inverter to the EMC Directive compliant EMC filter (SF).	According to capacities
	Radio noise filter	FR-BIF(H)	For radio noise reduction (connect to the input side)	Shared among all models
	Line noise filter	FR-BSF01 FR-BLF	For line noise reduction	
	Filterpack	FR-BFP2	Combination of power factor improving DC reactor, zero phase reactor, and capacitive filter	Three-phase power input model: compatible with 0.4K or bigger capacity
	Brake resistor	MRS type, MYS type	For increasing the regenerative braking capability (permissible duty 3%/6%ED)	200V: For the 0.4K or more
	High-duty brake resistor	FR-ABR	For increasing the regenerative braking capability (permissible duty 10%/6%ED)	
	Brake unit Resistor unit Discharging resistor	FR-BU2 FR-BR GZG, GRZG type	For increasing the braking capability of the inverter (for high-inertia load or negative load) Brake unit, electrical-discharge resistor and resistor unit are used in combination	For the 0.4K or more
	Power regeneration common converter Stand-alone reactor dedicated for the FR-CV	FR-CV FR-CVL	Unit which can return motor-generated braking energy back to the power supply in common converter system	According to capacities
High power factor converter	FR-HC2	The high power factor converter switches the converter section on/off to reshape an input current waveform into a sine wave, greatly suppressing harmonics. (Used in combination with the standard accessory.)	400V: According to capacities 400V: For the 5.5K or more	
Surge voltage suppression filter	FR-ASF	Filter for suppressing surge voltage on motor		
	FR-BMF			
FR series manual controller/ speed controller	Manual controller	FR-AX	For independent operation. With frequency meter, frequency potentiometer and start switch.	Shared among all models
	DC tach. follower	FR-AL	For synchronous operation (1VA) by external signal (0 to 5V, 0 to 10V DC)*	
	Three speed selector	FR-AT	For three speed switching, among high, middle and low speed operation (1.5VA)*	
	Motorized speed setter	FR-FK	For remote operation. Allows operation to be controlled from several places (5VA)*	
	Ratio setter	FR-FH	For ratio operation. The ratios of five inverters can be set (3VA)*	
	Speed detector	FR-FP	For tracking operation by a pilot generator (PG) signal (2VA)*	
	Master controller	FR-FG	Master controller (5VA) for parallel operation of multiple (maximum 35) inverters.*	
	Soft starter	FR-FC	For soft start and stop. Enables acceleration/deceleration in parallel operation (3VA)*	
	Deviation detector	FR-FD	For continuous speed control operation. Used in combination with a deviation sensor or synchro (5VA)*	
Pre-amplifier	FR-FA	Used as an A/V converter or arithmetic amplifier (3VA)*		
Others	Pilot generator	QVAH-10	For tracking operation. 70V/35VAC 500Hz (at 2500r/min)	Shared among all models
	Deviation sensor	YVGC-500W-NS	For continuous speed control operation (mechanical deviation detection) Output 90VAC/90°C	
	Frequency setting potentiometer	WA2W 1kΩ	For frequency setting. Wire-wound 2W 1kΩ type B characteristic	
	Analog frequency meter (64mm × 60mm)	YM206NRI 1mA	Dedicated frequency meter (graduated to 130Hz). Moving-coil type DC ammeter	
	Calibration resistor	RV24YN 10kΩ	For frequency meter calibration. Carbon film type B characteristic	
FR Configurator SW3(VFD setup software)	FR-SW3-SETUP-WE	Supports an inverter startup to maintenance.		

* Rated power consumption. The power supply specifications of the FR series manual controllers and speed controllers are 200VAC 50Hz, 220V/220VAC 60Hz, and 115VAC 60Hz.

- Features
- Standard Specifications
- Outline Dimension Drawings
- Terminal Connection Diagram Terminal Specification Explanation
- Operation panel Parameter unit
- Parameter List
- Protective Functions
- Options
- Instructions
- FR-D700 Series Specification Difference List
- Warranty International FA Center

Peripheral devices/cable size list

Voltage	Applicable inverter model	Motor output (kW)	Molded case circuit breaker (MCCB) *1 or earth leakage circuit breaker (ELB) *2 (NF, NV type)		Input side magnetic contactor *3		Recommended cable gauge (mm ²) *5		Reactor		
			Power factor improving (AC or DC) reactor connection		Power factor improving (AC or DC) reactor connection		R/L1, S/L2, T/L3 *4		U, V, W	FR-HAL	FR-HEL
			Without	With	Without	With	Without	With			
									Power factor improving (AC or DC) reactor connection	Power factor improving (AC or DC) reactor connection	
Three-Phase 200V	FR-D720-0.1K	0.1	5A	5A	S-T10	S-T10	2	2	2	0.4K *7	0.4K *7
	FR-D720-0.2K	0.2	5A	5A	S-T10	S-T10	2	2	2	0.4K *7	0.4K *7
	FR-D720-0.4K	0.4	5A	5A	S-T10	S-T10	2	2	2	0.4K	0.4K
	FR-D720-0.75K	0.75	10A	5A	S-T10	S-T10	2	2	2	0.75K	0.75K
	FR-D720-1.5K	1.5	15A	10A	S-T10	S-T10	2	2	2	1.5K	1.5K
	FR-D720-2.2K	2.2	20A	15A	S-T10	S-T10	2	2	2	2.2K	2.2K
	FR-D720-3.7K	3.7	30A	30A	S-T21	S-T10	3.5	3.5	3.5	3.7K	3.7K
	FR-D720-5.5K	5.5	50A	40A	S-T21	S-T21	5.5	5.5	5.5	5.5K	5.5K
	FR-D720-7.5K	7.5	60A	50A	S-T35	S-T35	14	8	8	7.5K	7.5K
	FR-D720-11K	11	75A	75A	S-T35	S-T35	14	14	14	11K	11K
	FR-D720-15K	15	125A	100A	S-T50	S-T50	22	22	22	15K	15K
	Three-phase 400V	FR-D740-0.4K	0.4	5A	5A	S-T10	S-T10	2	2	2	H0.4K
FR-D740-0.75K		0.75	5A	5A	S-T10	S-T10	2	2	2	H0.75K	H0.75K
FR-D740-1.5K		1.5	10A	10A	S-T10	S-T10	2	2	2	H1.5K	H1.5K
FR-D740-2.2K		2.2	15A	10A	S-T10	S-T10	2	2	2	H2.2K	H2.2K
FR-D740-3.7K		3.7	20A	15A	S-T10	S-T10	2	2	2	H3.7K	H3.7K
FR-D740-5.5K		5.5	30A	20A	S-T21	S-T12	3.5	2	2	H5.5K	H5.5K
FR-D740-7.5K		7.5	30A	30A	S-T21	S-T21	3.5	3.5	3.5	H7.5K	H7.5K
FR-D740-11K		11	50A	40A	S-T21	S-T21	5.5	5.5	5.5	H11K	H11K
FR-D740-15K	15	60A	50A	S-T35	S-T21	8	5.5	5.5	H15K	H15K	
Single-phase 200V	FR-D720S-0.1K	0.1	5A	5A	S-T10	S-T10	2	2	2	0.4K *7	0.4K *7
	FR-D720S-0.2K	0.2	5A	5A	S-T10	S-T10	2	2	2	0.4K *7	0.4K *7
	FR-D720S-0.4K	0.4	10A	10A	S-T10	S-T10	2	2	2	0.75K *7	0.75K *7
	FR-D720S-0.75K	0.75	15A	10A	S-T10	S-T10	2	2	2	1.5K *7	1.5K *7
	FR-D720S-1.5K	1.5	20A	20A	S-T10	S-T10	2	2	2	2.2K *7	2.2K *7
	FR-D720S-2.2K	2.2	40A	30A	S-T21	S-T10	3.5	3.5	2	3.7K *7	3.7K *7
Single-Phase 100V	FR-D710W-0.1K	0.1	10A	5A	S-T10	S-T10	2	2	2	0.75K *6*7	— *8
	FR-D710W-0.2K	0.2	10A	10A	S-T10	S-T10	2	2	2	1.5K *6*7	— *8
	FR-D710W-0.4K	0.4	15A	15A	S-T10	S-T10	2	2	2	2.2K *6*7	— *8
	FR-D710W-0.75K	0.75	30A	20A	S-T10	S-T10	3.5	3.5	2	3.7K *6*7	— *8

*1 Select an MCCB according to the inverter power supply capacity.
Install one MCCB per inverter.

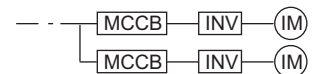

- *2 For the use in the United States or Canada, select a UL and cUL certified fuse with Class T fuse equivalent cut-off speed or faster with the appropriate rating for branch circuit protection. Alternatively, select a UL489 molded case circuit breaker (MCCB).
- *3 The magnetic contactor is selected based on the AC-1 class. The electrical durability of magnetic contactor is 500,000 times. When the magnetic contactor is used for emergency stops during motor driving, the electrical durability is 25 times.
If using an MC for emergency stop during motor driving, select an MC regarding the inverter input side current as JEM1038-AC-3 class rated current. When using an MC on the inverter output side for commercial-power supply operation switching using a general purpose motor, select an MC regarding the motor rated current as JEM1038-AC-3 class rated current.
- *4 When using single-phase power input, terminals are R/L1 and S/L2.
- *5 The cable size is that of the cable (HIV cable (600V class 2 vinyl-insulated cable) etc.) with continuous maximum permissible temperature of 75°C. Assumes that the surrounding air temperature is 50°C or less and the wiring distance is 20m or less.
- *6 When connecting a single-phase 100V power input model to a power transformer (50kVA or more), install an AC reactor (FR-HAL) so that the performance is more reliable.
- *7 The power factor may be slightly lower.
- *8 Single-phase 100V power input model is not compatible with DC reactor.



Note

- When the inverter capacity is larger than the motor capacity, select an MCCB and a magnetic contactor according to the inverter model and cable and reactor according to the motor output.
- When the breaker on the inverter primary side trips, check for the wiring fault (short circuit), damage to internal parts of the inverter, etc. Identify the cause of the trip, then remove the cause and power on the breaker.

Selecting the rated sensitivity current for the earth leakage current breaker

When using the earth leakage current breaker with the inverter circuit, select its rated sensitivity current as follows, independently of the PWM carrier frequency.

- Breaker designed for harmonic and surge suppression
Rated sensitivity current $I_{\Delta n} \geq 10 \times (I_{g1} + I_{gn} + I_{gi} + I_{g2} + I_{gm})$
- Standard breaker
Rated sensitivity current $I_{\Delta n} \geq 10 \times \{I_{g1} + I_{gn} + I_{gi} + 3 \times (I_{g2} + I_{gm})\}$
I_{g1}, I_{g2}: Leakage currents in wire path during commercial power supply operation
I_{gn} : Leakage current of inverter input side noise filter
I_{gm} : Leakage current of motor during commercial power supply operation
I_{gi} : Leakage current of inverter unit

Example of leakage current of cable path per 1km during the commercial power supply operation when the CV cable is routed in metal conduit (200V 60Hz)

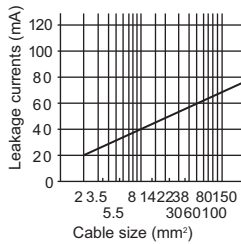

Example of leakage current per 1km during the commercial power supply operation when the CV cable is routed in metal conduit (Three-phase three-wire delta connection 400V/60Hz)

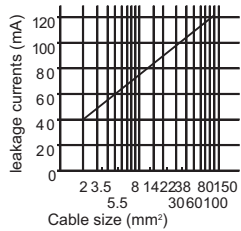

Example of leakage current of three-phase induction motor during the commercial power supply operation (200V 60Hz)

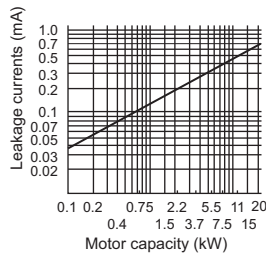

Example of leakage current of three-phase induction motor during the commercial power supply operation (Totally-enclosed fan-cooled type motor 400V/60Hz)

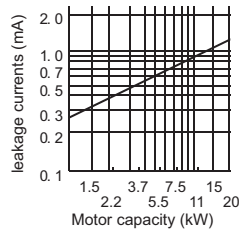

For "Δ" connection, the amount of leakage current is approx. 1/3 of the above value.

Example

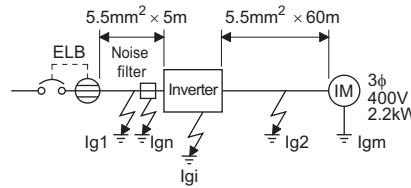

- (Note) 1 Install the earth leakage breaker (ELB) on the input side of the inverter.
2 In the Δ connection earthed-neutral system, the sensitivity current is blunt against an earth (ground) fault in the inverter output side. Earthing (Grounding) must conform to the requirements of national and local safety regulations and electrical codes. (NEC section 250, IEC 536 class 1 and other applicable standards)

● Selection example

(in the case of the above figure (400V class Δ connection))

	Breaker Designed for Harmonic and Surge Suppression	Standard Breaker
Leakage current I _{g1} (mA)	$\frac{1}{3} \times 66 \times \frac{5m}{1000m} = 0.11$	
Leakage current I _{gn} (mA)	0 (without noise filter)	
Leakage current I _{gi} (mA)	1	
Leakage current I _{g2} (mA)	$\frac{1}{3} \times 66 \times \frac{60m}{1000m} = 1.32$	
Motor leakage current I _{gm} (mA)	0.36	
Total leakage current (mA)	2.79	6.15
Rated sensitivity current (mA) (≥ I _g × 10)	30	100

Features

Standard Specifications

Outline Dimension Drawings

Terminal Connection Diagram Terminal Specification Explanation

Operation panel Parameter unit

Parameter List

Protective Functions

Options

Instructions

FR-D700 Series Specification Difference List

Warranty International FA Center

Precautions for Operation/Selection

Precautions for use of the inverter

⚠ Safety Precautions

- To operate the inverter correctly and safely, be sure to read the "instruction manual" before starting operation.
- This product has not been designed or manufactured for use with any equipment or system operated under life-threatening conditions.
- Please contact our sales office when you are considering using this product in special applications such as passenger mobile, medical, aerospace, nuclear, power or undersea relay equipment or system.
- Although this product is manufactured under strict quality control, safety devices should be installed when a serious accident or loss is expected by a failure of this product.
- The load used should be a three-phase induction motor only.

Operation

- A magnetic contactor (MC) provided on the input side should not be used to make frequent starts and stops. It could cause the inverter to fail.
- However, at this time, the motor cannot be brought to a sudden stop. Hence, provide a mechanical stopping/holding mechanism for the machine/equipment which requires an emergency stop.
- It will take time for the capacitor to discharge after shutoff of the inverter power supply. When accessing the inverter for inspection, wait for at least 10 minutes after the power supply has been switched off, and check to make sure that there are no residual voltage using a tester or the like.

Wiring

- Application of power to the output terminals (U, V, W) of the inverter will damage the inverter. Therefore, fully check the wiring and sequence to ensure that wiring is correct, etc. before powering on.
- The terminals P/+, PR, P1, N/- are provided for connection of a dedicated option. Connect only a dedicated option. Do not short the frequency setting power supply terminal 10 and common terminal 5 or the terminal PC and terminal SD.
- When disconnecting a wire from a control circuit terminal, push the open/close button all the way down with a flathead screwdriver, and pull out the wire. Pulling out the wire forcefully without pushing the open/close button all the way down may damage the terminal block.

Power supply

- When the inverter is connected under a large-capacity power transformer (500kVA or more transformer) or when a power capacitor is to be switched over, an excessive peak current may flow in the power input circuit, damaging the inverter.

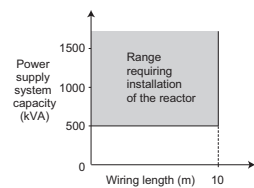

- To prevent this, always install an optional AC reactor (FR-HAL). When connecting a single-phase 100V power input model to a power transformer (50kVA or more), install an AC reactor (FR-HAL) so that the performance is more reliable.
- If a surge voltage occurs in the power supply system, this surge energy may flow into the inverter, causing the inverter to display overvoltage protection (E.OV□) and come to an inverter trip. To prevent this, always install an optional AC reactor (FR-HAL).

Installation

- Avoid hostile environment where oil mist, fluff, dust particles, etc. are suspended in the air, and install the inverter in a clean place or put it in an ingress-protected "enclosed" enclosure. When placing the inverter in an enclosure, determine the cooling system and enclosure dimensions so that the surrounding air temperature of the inverter is within the permissible value. (refer to page 10 for the specified value)
- Do not install the inverter on wood or other combustible material as it will be hot partly.
- Install the inverter in the vertical orientation.

Setting

- The inverter can be operated as fast as a maximum of 400Hz by parameter setting. Therefore, incorrect setting can cause a danger. Set the upper limit using the maximum frequency limit setting function.
- A setting higher than the initial value of DC injection brake operation voltage or operation time can cause motor overheat (electronic thermal relay error).
- Do not set Pr. 70 *Special regenerative brake duty* except for using the optional brake resistor. This function is used to protect the brake resistor from overheating. Do not set the value exceeding permissible duty of the brake resistor.

Precautions for selection

Inverter capacity selection

- When operating a special motor or more than one motor in parallel with a single inverter, select the inverter capacity so that 1.05 times the total rated motor current is less than the rated output current of the inverter.

Starting torque of the motor

- The start and acceleration characteristics of the motor driven by the inverter are restricted by the overload current rating of that inverter. Generally the torque characteristic is less than when the motor is started by a commercial power supply. If torque boost adjustment or General-purpose magnetic flux vector control cannot provide enough torque when a large starting torque is necessary, select the inverter of one rank higher capacity or increase the capacities of both the motor and inverter.

Acceleration/deceleration times

- The acceleration/deceleration time of the motor depends on the motor-generated torque, load torque and moment of inertia of the load (J).
- When the stall prevention function is activated during acceleration/deceleration, increase the acceleration/deceleration time as the actual time may become longer.
- To decrease the acceleration/deceleration time, increase the torque boost value (setting of a too large value may activate the stall prevention function at a start, longer the acceleration time), use the General-purpose magnetic flux vector control or increase the inverter and motor capacities. To decrease the deceleration time, it is necessary to add optional brake resistor MRS type, MYS type, FR-ABR (for the 0.4K or more), the brake unit (FR-BU2), power regeneration common converter (FR-CV), or a similar device to absorb braking energy.

Power transfer mechanism

(reduction gear, belt, chain, etc.)

- When an oil-lubricated gear box, speed change/reduction gear or similar device is used in the power transfer system, note that continuous operation at low speed only may deteriorate oil lubrication, causing seizure. When performing fast operation at higher than 60Hz, fully note that such operation will cause strength shortage due to the noise, life or centrifugal force of the power transfer mechanism.

Instructions for overload operation

- When performing operation of frequent start/stop of the inverter, rise/fall in the temperature of the transistor element of the inverter will repeat due to a repeated flow of large current, shortening the life from thermal fatigue. Since thermal fatigue is related to the amount of current, the life can be increased by reducing current at locked condition, starting current, etc. Decreasing current may increase the life. However, decreasing current will result in insufficient torque and the inverter may not start. Therefore, choose the inverter which has enough allowance for current.

Features

Standard Specifications

Outline Dimension Drawings

Terminal Connection Diagram
Terminal Specification Explanation

Operation panel Parameter unit

Parameter List

Protective Functions

Options

Instructions

FR-D700 Series Specification Difference List

Warranty International FA Center

Precautions for Peripheral Device Selection

Installation and selection of moulded case circuit breaker

Install a moulded case circuit breaker (MCCB) on the power receiving side to protect the wiring of the inverter input side. For MCCB selection, refer to *page 28* since it depends on the inverter power supply side power factor (which changes depending on the power supply voltage, output frequency and load). Especially for a completely electromagnetic MCCB, one of a slightly large capacity must be selected since its operation characteristic varies with harmonic currents. (Check it in the data of the corresponding breaker.) As an earth leakage current breaker, use the Mitsubishi earth leakage current breaker designed for harmonics and surge suppression. (*Refer to page 29*)

When installing a moulded case circuit breaker on the output side of the inverter, contact each manufacturer for selection of the moulded case circuit breaker.

Handling of the inverter input side magnetic contactor

- For operation via external terminal (terminal STF or STR used), provide an input side MC to prevent an accident caused by a natural restart at power recovery after a power failure, such as an instantaneous power failure, and to ensure safety for maintenance work. Do not use this magnetic contactor to make frequent starts and stops. (The switching life of the inverter input circuit is about 1,000,000 times.) For parameter unit operation, an automatic restart after power failure is not made and the MC cannot be used to make a start. Note that the primary side MC may be used to make a stop but the regenerative brake specific to the inverter does not operate and the motor is coasted to a stop.
- Installation of a magnetic contactor at the input side is recommended. A magnetic contactor avoids overheat or burnout of a brake resistor when heat capacity of the resistor is insufficient or a brake regenerative transistor is damaged with short while connecting an optional brake resistor. In this case, shut-off the magnetic contactor when fault occurs and inverter trips.

Handling of the inverter output side magnetic contactor

Switch the magnetic contactor between the inverter and motor only when both the inverter and motor are at a stop. When the magnetic contactor is turned on while the inverter is operating, overcurrent protection of the inverter and such will activate. When an MC is provided for switching to the commercial power supply, for example, switch it on/off after the inverter and motor have stopped.

Thermal relay installation

The inverter has an electronic thermal relay function to protect the motor from overheating. However, when running multiple motors with one inverter or operating a multi-pole motor, provide a thermal relay (OCR) between the inverter and motor. In this case, set the electronic thermal relay function of the inverter to 0A. And for the setting of the thermal relay, add the line-to-line leakage current (*refer to page 33*) to the current value on the motor rating plate.

For low-speed operation where the cooling capability of the motor reduces, it is recommended to use a thermal relay protector incorporated motor.

Measuring instrument on the output side

When the inverter-to-motor wiring length is large, especially in the 400V class, small-capacity models, the meters and CTs may generate heat due to line-to-line leakage current. Therefore, choose the equipment which has enough allowance for the current rating.

Disuse of power factor improving capacitor (power capacitor)

The power factor improving capacitor and surge suppressor on the inverter output side may be overheated or damaged by the harmonic components of the inverter output. Also, since an excessive current flows in the inverter to activate overcurrent protection, do not install a capacitor or surge suppressor. For power factor improvement, use a DC reactor.

Electrical corrosion of the bearing

- When a motor is driven by the inverter, axial voltage is generated on the motor shaft, which may cause electrical corrosion of the bearing in rare cases depending on the wiring, load, operating conditions of the motor or specific inverter settings (high carrier frequency, use of a capacitive filter*1). Contact your sales representative to take appropriate countermeasures for the motor. The following shows examples of countermeasures for the inverter.

- Decrease the carrier frequency.
- Remove the capacitive filter.
- Provide a common mode choke*2 on the output side of the inverter. (This is effective regardless of the use of the capacitive filter.)

*1 Mitsubishi capacitive filter: FR-BIF, SF[], FR-E5NF-[], FR-S5NFS[A][], FR-BFP2-[]

*2 Recommended common mode choke: FT-3KM F series FINEMET® common mode choke cores manufactured by Hitachi Metals, Ltd. FINEMET is a registered trademark of Hitachi Metals, Ltd.

Wire thickness and wiring distance

When the wiring length between the inverter and motor is long, use thick wires so that the voltage drop of the main circuit cable is 2% or less especially at low frequency output. (A selection example for the wiring distance of 20m is shown on *page 28*)

Especially at a long wiring distance, the maximum wiring length should be within the length in the table below since the overcurrent protection function may be misactivated by the influence of a charging current due to the stray capacitances of the wiring.

(The overall wiring length for connection of multiple motors should be within the value in the table below.)

Pr. 72 Setting (carrier frequency)	0.1K	0.2K	0.4K	0.75K	1.5K	2.2K	3.7K or more
1 or less	100V	200m	200m	300m	500m	500m	500m
	200V	—	—	200m	200m	300m	500m
2 to 15	400V	—	—	200m	200m	300m	500m
	100V	30m	100m	200m	300m	500m	500m
	200V	—	—	30m	100m	200m	300m
	400V	—	—	30m	100m	200m	300m

When using the automatic restart after instantaneous power failure function with wiring length exceeding below, select "without frequency search" (*Pr.162* = "1, 11").

Motor Capacity	0.1K	0.2K	0.4K or more
Wiring Length	20m	50m	100m

Use the recommended connection cable when connecting the parameter unit.

For remote operation via analog signal, wire the control cable between the operation box or operation signal and inverter within 30m and away from the power circuits (main circuit and relay sequence circuit) to prevent induction from other devices.

When using the external potentiometer instead of the parameter unit to set the frequency, use a shielded or twisted cable, and do not earth (ground) the shield, but connect it to terminal 5 as shown below.

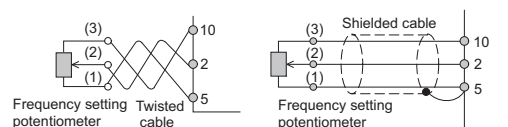

Earth (Ground)

When the inverter is run in the low acoustic noise mode, more leakage currents occur than in the non-low acoustic noise mode due to high-speed switching operation. Be sure to earth (ground) the inverter and motor before use. In addition, always use the earth (ground) terminal of the inverter to earth (ground) the inverter. (Do not use the case and chassis)

Noise

When performing low-noise operation at higher carrier frequency, electromagnetic noise tends to increase. Therefore, refer to the following measure example and consider taking the measures. Depending on the installation condition, the inverter may be affected by noise in a non-low noise (initial) status.

- The noise level can be reduced by decreasing the carrier frequency (Pr. 72).
- As measures against AM radio broadcasting noise, radio noise filter FR-BIF produces an effect.
- As measures against sensor malfunction, line noise filter FR-BSF01, FR-BLF produces an effect.
- As measures against induction noise from the power cable of the inverter, an effect is produced by putting a distance of 30cm (at least 10cm) or more and using a twisted pair shielded cable as a signal cable. Do not earth (ground) shield but connect it to signal common cable.

Noise reduction examples

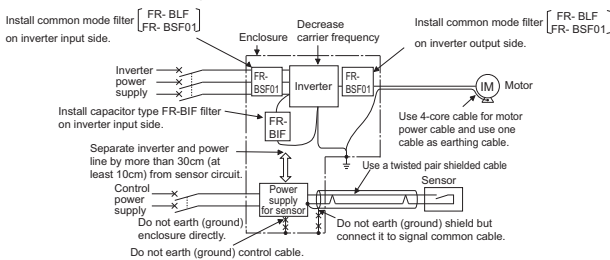

Leakage currents

Capacitances exist between the inverter I/O cables, other cables and earth and in the motor, through which a leakage current flows. Since its value depends on the static capacitances, carrier frequency, etc., low acoustic noise operation at the increased carrier frequency of the inverter will increase the leakage current. Therefore, take the following measures. Select the earth leakage current breaker according to its rated sensitivity current, independently of the carrier frequency setting. (Refer to page 29)

To-earth (ground) leakage currents

Type	Influence and Measures
Influence and measures	<ul style="list-style-type: none"> ● Leakage currents may flow not only into the inverter's own line but also into the other line through the earth (ground) cable, etc. These leakage currents may operate earth (ground) leakage circuit breakers and earth leakage relays unnecessarily. ● Countermeasures ● If the carrier frequency setting is high, decrease the Pr. 72 PWM frequency selection setting. Note that motor noise increases. Select Pr. 240 Soft-PWM operation selection to make the sound inoffensive. ● By using earth leakage circuit breakers designed for harmonic and surge suppression in the inverter's own line and other line, operation can be performed with the carrier frequency kept high (with low noise).
Undesirable current path	

Line leakage current

Type	Influence and Measures
Influence and measures	<ul style="list-style-type: none"> ● This leakage current flows via a static capacitance between the inverter output cables. ● The external thermal relay may be operated unnecessarily by the harmonics of the leakage current. When the wiring length is long (50m or more) for the 400V class model, the external thermal relay is likely to operate unnecessarily because the ratio of the leakage current to the rated motor current increases. ● Countermeasures ● Use Pr.9 Electronic thermal O/L relay. ● If the carrier frequency setting is high, decrease the Pr. 72 PWM frequency selection setting. Note that motor noise increases. Select Pr. 240 Soft-PWM operation selection to make the sound inoffensive. To ensure that the motor is protected against line-to-line leakage currents, it is recommended to use a temperature sensor to directly detect motor temperature.
Undesirable current path	

●Harmonic suppression guideline

Inverters have a converter section (rectifier circuit) and generate a harmonic current. Harmonic currents flow from the inverter to a power receiving point via a power transformer. The harmonic suppression guideline was established to protect other consumers from these outgoing harmonic currents.

The three-phase 200V input specifications 3.7kW or less, single-phase 200V input specifications 2.2kW or less, single-phase 100V input specifications 0.75kW or less are previously covered by "Harmonic suppression guideline for household appliances and general-purpose products" and other models are covered by "Harmonic suppression guideline for consumers who receive high voltage or special high voltage". However, the transistorized inverter has been excluded from the target products covered by "Harmonic suppression guideline for household appliances and general-purpose products" in January 2004 and "Harmonic suppression guideline for household appliances and general-purpose products" was repealed on September 6, 2004.

All capacity and all models of general-purpose inverter used by specific consumers are covered by "Harmonic suppression guideline for consumers who receive high voltage or special high voltage".

- "Harmonic suppression guideline for consumers who receive high voltage or special high voltage" This guideline sets forth the maximum values of harmonic currents outgoing from a high-voltage or especially high-voltage consumer who will install, add or renew harmonic generating equipment. If any of the maximum values is exceeded, this guideline requires that consumer to take certain suppression measures. Users who use models other than the target models are not covered by the guideline. However, we ask to connect an AC reactor or a DC reactor as before to the users who are not covered by the guideline. For compliance to the harmonic suppression guideline for consumers who receive high voltage or special high voltage

- Features
- Standard Specifications
- Outline Dimension Drawings
- Terminal Connection Diagram Terminal Specification Explanation
- Operation panel Parameter unit
- Parameter List
- Protective Functions
- Options
- Instructions
- FR-D700 Series Specification Difference List
- Warranty International FA Center

Input Power Supply	Target Capacity	Countermeasures
Single-phase 100V Single-phase 200V Three-phase 200V Three-phase 400V	All capacities	<p>Make a judgment based on "Harmonic suppression guideline for consumers who receive high voltage or special high voltage" issued by the Japanese Ministry of Economy, Trade and Industry (formerly Ministry of International Trade and Industry) in September 1994 and take measures if necessary. For calculation method of power supply harmonics, refer to materials below.</p> <p>Reference materials</p> <ul style="list-style-type: none"> "Harmonic suppression measures of the inverter" Jan. 2004 Japan Electrical Manufacturer's Association "Calculation method of harmonic current of the general-purpose inverter used by specific consumers" <p>JEM-TR201 (revised in Dec. 2003): Japan Electrical Manufacturer's Association Japan Electrical Manufacturer's Association</p>

For compliance to "Harmonic suppression guideline of the transistorized inverter (input current of 20A or less) for consumers other than specific consumers" published by JEMA.

Input Power Supply	Target Capacity	Countermeasures
Single-phase 100V	0.75kW or less	Connect the AC reactor or DC reactor recommended in a catalog or an instruction manual.
Single-phase 200V	2.2kW or less	Reference materials
Three-phase 200V	3.7kW or less	<ul style="list-style-type: none"> "Harmonic suppression guideline of the general-purpose inverter (input current of 20A or less)" <p>JEM-TR226 (revised in Dec. 2003): Japan Electrical Manufacturer's Association</p>

● Calculation of outgoing harmonic current

Outgoing harmonic current = fundamental wave current (value converted from received power voltage) × operation ratio × harmonic content

• Operation ratio: Operation ratio = actual load factor / operation time ratio during 30 minutes

• Harmonic content: Found in Table.

Table 1: Harmonic Contents (Values at the fundamental current of 100%)

	Reactor	5th	7th	11th	13th	17th	19th	23rd	25th
Three-phase bridge (capacitor smoothing)	Not used	65	41	8.5	7.7	4.3	3.1	2.6	1.8
	Used (AC side)	38	14.5	7.4	3.4	3.2	1.9	1.7	1.3
	Used (DC side)	30	13	8.4	5.0	4.7	3.2	3.0	2.2
	Used (AC, DC sides)	28	9.1	7.2	4.1	3.2	2.4	1.6	1.4
Single-phase bridge (capacitor smoothing, double voltage rectification)	Not used	50	24	5.1	4.0	1.5	1.4	—	—
	Used (AC side)	6.0	3.9	1.6	1.2	0.6	0.1	—	—
Single-phase bridge (capacitor smoothing, full-wave rectification)	Not used	60	33.5	6.1	6.4	2.6	2.7	1.5	1.5
	Used (AC side)	31.9	8.3	3.8	3.0	1.7	1.4	1.0	0.7

Table 2: Rated Capacities and Outgoing Harmonic Currents for Three-phase Inverter Drive

Applied Motor kW	Fundamental Wave Current (A)		Fundamental Wave Current Converted from 6.6kV (mA)	Rated Capacity (kVA)	Outgoing Harmonic Current Converted from 6.6kV (mA) (No reactor, 100% operation ratio)							
	200V	400V			5th	7th	11th	13th	17th	19th	23rd	25th
0.4	1.61	0.81	49	0.57	31.85	20.09	4.165	3.773	2.107	1.519	1.274	0.882
0.75	2.74	1.37	83	0.97	53.95	34.03	7.055	6.391	3.569	2.573	2.158	1.494
1.5	5.50	2.75	167	1.95	108.6	68.47	14.20	12.86	7.181	5.177	4.342	3.006
2.2	7.93	3.96	240	2.81	156.0	98.40	20.40	18.48	10.32	7.440	6.240	4.320
3.7	13.0	6.50	394	4.61	257.1	161.5	33.49	30.34	16.94	12.21	10.24	7.092
5.5	19.1	9.55	579	6.77	376.1	237.4	49.22	44.58	24.90	17.95	15.05	10.42
7.5	25.6	12.8	776	9.07	504.4	318.2	65.96	59.75	33.37	24.06	20.18	13.97
11	36.9	18.5	1121	13.1	728.7	459.6	95.29	86.32	48.20	34.75	29.15	20.18
15	49.8	24.9	1509	17.6	980.9	618.7	128.3	116.2	64.89	46.78	39.24	27.16

Table 3: Conversion factors

Classification	Circuit Type	Conversion Factor K _I	
3	Three-phase bridge (capacitor smoothing)	Without reactor	K31=3.4
		With reactor (AC side)	K32=1.8
		With reactor (DC side)	K33=1.8
		With reactors (AC, DC sides)	K34=1.4
4	Single-phase bridge (capacitor smoothing, double voltage rectification)	Without reactor	K41=2.3
		With reactor (AC side)	K42=0.35
	Single-phase bridge (capacitor smoothing, full-wave rectification)	Without reactor	K43=2.9
		With reactor (AC side)	K44=1.3
5	Self-excitation three-phase bridge	When a high power factor converter is used	K5=0

FR-D700 Series Specification Difference List

Item	Japanese Specification	NA Specification	EC Specification	CHT Specification
Applicable Capacity Type	FR-D720-0.1K to 15K FR-D740-0.4K to 15K FR-D720S-0.1K to 2.2K FR-D710W-0.1K to 0.75K Type : Rated capacity (kW)	FR-D720-008 to 318-NA FR-D740-012 to 160-NA FR-D720S-008 to 100-NA FR-D710W-008 to 042-NA Type : Rated current value	FR-D740-012 to 160-EC FR-D720S-008 to 100-EC Type : Rated current value	FR-D740-0.4K to 7.5K-CHT FR-D720S-0.1K to 2.2K-CHT Type : Rated capacity (kW)
Main Circuit Terminal Name	R, S, T		L1, L2, L3	
AC Power Input				
Three-phase Input				
Single-phase Input	R, S		L1, N	
Brake Unit Connection	P, N		+, -	
Control Terminal Logic Initial Setting	Sink logic	Sink logic	Source logic	Sink logic
Control Terminal Contact Input Common Terminal Initial Setting	SD	SD	PC	SD
Monitor Output Terminal For Indicator	FM (Digital output)	AM (Analog output)	AM (Analog output)	AM (Analog output)
Parameter				
<i>Pr.3, Pr.4, Pr.20, Pr.55, Pr.66, Pr.84, Pr.125, Pr.126, Pr.903, Pr.905, Pr.923</i> Initial Value	60Hz	60Hz	50Hz	50Hz
<i>Pr.19</i> Initial Value	9999	9999	8888	9999
<i>Pr.122</i> Initial Value	0	9999	9999	0
<i>Pr.145</i> Initial Value	0	1	1	1
<i>Pr.160</i> Initial Value	9999	0	0	9999
<i>Pr.249</i> Initial Value	0	0	1	1
Indicator Output Terminal Function	<i>Pr.54 FM terminal function selection, Pr.900 FM terminal calibration</i>	<i>Pr.158 AM terminal function selection, Pr.901 AM terminal calibration</i>	<i>Pr.158 AM terminal function selection, Pr.901 AM terminal calibration</i>	<i>Pr.158 AM terminal function selection, Pr.901 AM terminal calibration</i>
Traverse Function <i>Pr.592 to Pr.597</i>	Without	Without	With	With

- Features
- Standard Specifications
- Outline Dimension Drawings
- Terminal Connection Diagram Terminal Specification Explanation
- Operation panel Parameter unit
- Parameter List
- Protective Functions
- Options
- Instructions
- FR-D700 Series Specification Difference List
- Warranty International FA Center

Warranty

When using this product, make sure to understand the warranty described below.

1. Warranty period and coverage

We will repair any failure or defect (hereinafter referred to as "failure") in our FA equipment (hereinafter referred to as the "Product") arisen during warranty period at no charge due to causes for which we are responsible through the distributor from which you purchased the Product or our service provider. However, we will charge the actual cost of dispatching our engineer for an on-site repair work on request by customer in Japan or overseas countries. We are not responsible for any on-site readjustment and/or trial run that may be required after a defective unit are repaired or replaced.

[Term]

The term of warranty for Product is twelve months after your purchase or delivery of the Product to a place designated by you or eighteen months from the date of manufacture whichever comes first ("Warranty Period"). Warranty period for repaired Product cannot exceed beyond the original warranty period before any repair work.

[Limitations]

- (1) You are requested to conduct an initial failure diagnosis by yourself, as a general rule. It can also be carried out by us or our service company upon your request and the actual cost will be charged.
However, it will not be charged if we are responsible for the cause of the failure.
- (2) This limited warranty applies only when the condition, method, environment, etc. of use are in compliance with the terms and conditions and instructions that are set forth in the instruction manual and user manual for the Product and the caution label affixed to the Product.
- (3) Even during the term of warranty, the repair cost will be charged on you in the following cases;
 - 1) a failure caused by your improper storing or handling, carelessness or negligence, etc., and a failure caused by your hardware or software problem
 - 2) a failure caused by any alteration, etc. to the Product made on your side without our approval
 - 3) a failure which may be regarded as avoidable, if your equipment in which the Product is incorporated is equipped with a safety device required by applicable laws and has any function or structure considered to be indispensable according to a common sense in the industry
 - 4) a failure which may be regarded as avoidable if consumable parts designated in the instruction manual, etc. are duly maintained and replaced
 - 5) any replacement of consumable parts (condenser, cooling fan, etc.)
 - 6) a failure caused by external factors such as inevitable accidents, including without limitation fire and abnormal fluctuation of voltage, and acts of God, including without limitation earthquake, lightning and natural disasters
 - 7) a failure generated by an unforeseeable cause with a scientific technology that was not available at the time of the shipment of the Product from our company
 - 8) any other failures which we are not responsible for or which you acknowledge we are not responsible for

2. Term of warranty after the stop of production

- (1) We may accept the repair at charge for another seven (7) years after the production of the product is discontinued. The announcement of the stop of production for each model can be seen in our Sales and Service, etc.
- (2) Please note that the Product (including its spare parts) cannot be ordered after its stop of production.

3. Service in overseas

Our regional FA Center in overseas countries will accept the repair work of the Product; however, the terms and conditions of the repair work may differ depending on each FA Center. Please ask your local FA center for details.

4. Exclusion of loss in opportunity and secondary loss from warranty liability

Regardless of the gratis warranty term, Mitsubishi shall not be liable for compensation to:

- (1) Damages caused by any cause found not to be the responsibility of Mitsubishi.
- (2) Loss in opportunity, lost profits incurred to the user by Failures of Mitsubishi products.
- (3) Special damages and secondary damages whether foreseeable or not, compensation for accidents, and compensation for damages to products other than Mitsubishi products.
- (4) Replacement by the user, maintenance of on-site equipment, start-up test run and other tasks.

5. Change of Product specifications

Specifications listed in our catalogs, manuals or technical documents may be changed without notice.

6. Application and use of the Product

- (1) For the use of our product, its applications should be those that may not result in a serious damage even if any failure or malfunction occurs in product, and a backup or fail-safe function should operate on an external system to product when any failure or malfunction occurs.
- (2) Our product is designed and manufactured as a general purpose product for use at general industries.
Therefore, applications substantially influential on the public interest for such as atomic power plants and other power plants of electric power companies, and also which require a special quality assurance system, including applications for railway companies and government or public offices are not recommended, and we assume no responsibility for any failure caused by these applications when used.
In addition, applications which may be substantially influential to human lives or properties for such as airlines, medical treatments, railway service, incineration and fuel systems, man-operated material handling equipment, entertainment machines, safety machines, etc. are not recommended, and we assume no responsibility for any failure caused by these applications when used.
We will review the acceptability of the abovementioned applications, if you agree not to require a specific quality for a specific application. Please contact us for consultation.

Features

Standard Specifications

Outline Dimension Drawings

Terminal Connection Diagram
Terminal Specification Explanation

Operation panel Parameter unit

Parameter List

Protective Functions

Options

Instructions

FR-D700 Series Specification Difference List

Warranty International FA Center

We visualize our customers' factories to solve problems and troubles.

"Visualization" of production and energy achieves future factories that advance one step forward.

The integrated solution, e-F@ctory, is based on our consolidated know-how, which has been developed through our own experiences as a user of FA products. Our e-F@ctory provides total cost reduction ranging from development to production and maintenance to achieve optimized production. This solution makes it possible to save energy and to optimize production by "visualization" that links upstream information systems and production site information, thus solving various problems on production sites.

Sharing information across production systems

MES Interface

Information sharing is easy and inexpensive because communication gateways, such as personal computers, are not necessary to connect factory equipment to the Manufacturing Execution System (MES).

Optimizing production from a TCO* stand point

iQ Platform

Factory automation components such as controllers, human-machine interfaces, engineering environments, and networks are all seamlessly integrated to reduce TCO across different stages, from development to production and maintenance.

* TCO: Total Cost of Ownership



Visualization of energy consumption

e&eco-F@ctory

It is indispensable for today's factory to be energy conscious and efficient. The e-F@ctory solution enables management of specific energy consumption, which provides the visibility needed to improve productivity. Additionally, this solution takes the total life cycle into account, including factors such as "measurement and diagnosis", "countermeasures", and "operation and management". Backed by several successes and achievements, our know-how will support your energy saving efforts.



Network

CC-Link Family, the open field network of the world standard, and SSCNET III/H, the servo network for achieving high-speed processing and enhancement of instruction synchronization, flexibly expanding the connectivity among equipment and devices in the e-F@ctory environment.

iQ Platform-compatible equipment

The inter-multi-CPU high-speed base unit provides slots for arbitrarily connecting programmable controllers, motion controllers, on-line CNCs, and robot controllers. Data communication speed among devices is enhanced, and their compatibility is extremely improved.

iQ Platform-compatible engineering environments

Design information is integrated and shared at stages from system design to programming, tests and startup, and operation and maintenance. In addition, programming software programs for programmable controllers, motion controllers, on-line CNCs, robots, inverters, and GOTs, which are separately provided in a conventional environment, can be integrated.



e-Factory

Products for achieving e-F@ctory

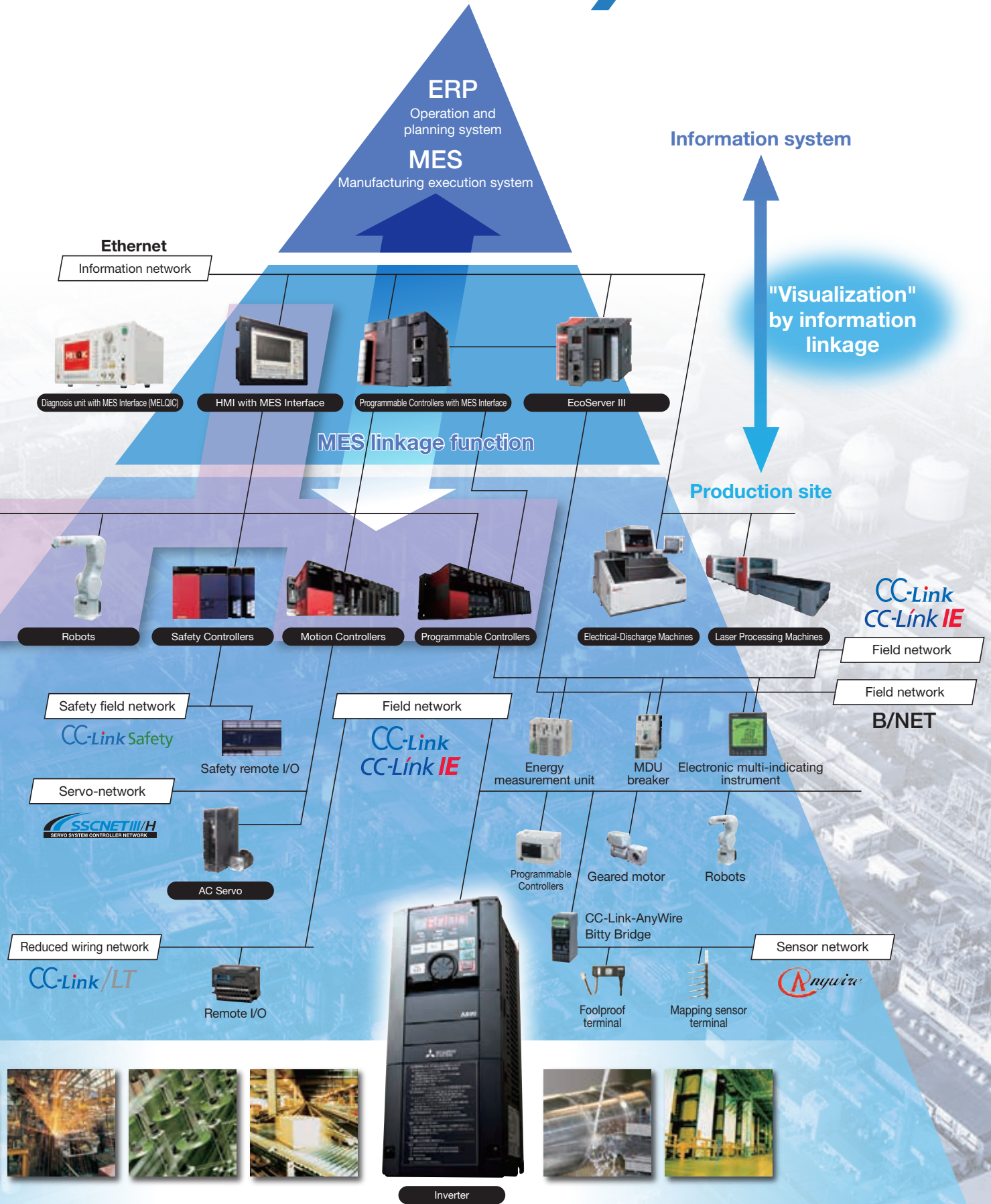

Mitsubishi Electric's global FA network delivers reliable technologies and security around the world.

■ Production base ● Development center ● Global FA Center ▲ Mechatronics showroom ● Mitsubishi Electric sales office

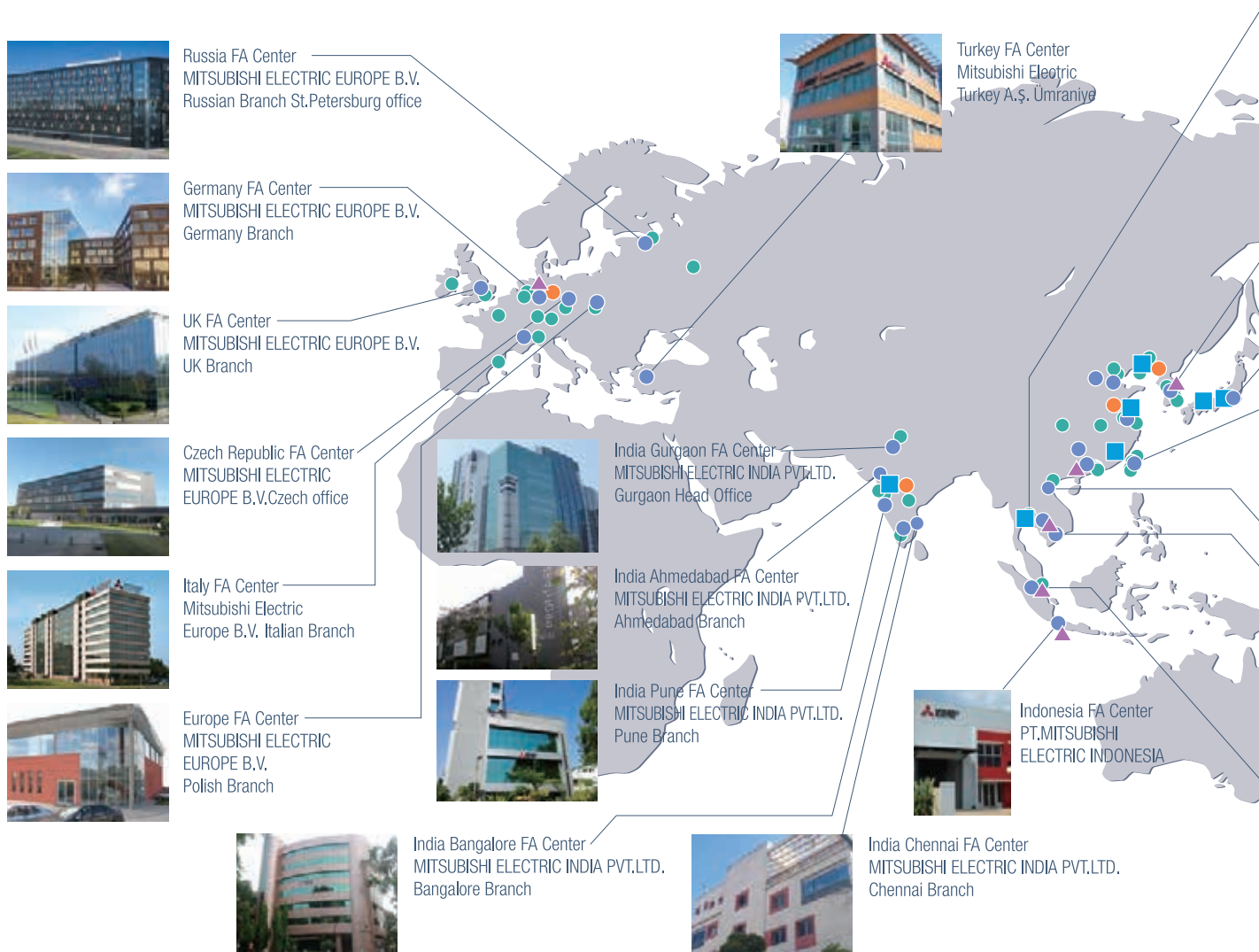

Available services



Technical consultation (engineering)

Our Japanese and/or local staff offer technical advice, and can also propose the best products and systems for a customer's specific application needs.



Showrooms

The latest automation technologies, including programmable controllers, HMI's, inverters, servo systems, and industrial automation machinery such as electrical-discharge machines, laser processing machines, CNCs, and industrial robots can be seen at Mitsubishi Electric showrooms.



Training

From basic operations to applied programming, our training schools offer regular courses that use actual machines. We also offer customized training programs and onsite training sessions.



Technical support

Our FA centers and service shops work together to provide repairs, onsite engineering support, and spare parts.



Repairs

Handle repairs of our FA products.

Thailand FA Center
MITSUBISHI ELECTRIC FACTORY
AUTOMATION (THAILAND) CO.,LTD



Korea FA Center
MITSUBISHI ELECTRIC
AUTOMATION KOREA CO.,LTD.



MITSUBISHI ELECTRIC CORPORATION
Factory Automation Systems Group



Taichung FA Center
MITSUBISHI ELECTRIC
TAIWAN CO.,LTD



Taipei FA Center
SETSUYO ENTERPRISE CO.,LTD



Ho Chi Minh FA Center
MITSUBISHI ELECTRIC
VIETNAM COMPANY
LIMITED



Hanoi FA center
Mitsubishi Electric
Vietnam
Company Limited
Hanoi Branch



ASEAN FA Center
MITSUBISHI ELECTRIC ASIA PTE.LTD.



North America FA Center
MITSUBISHI ELECTRIC
AUTOMATION, INC.



Mexico Monterrey FA Center
Monterrey Office, Mitsubishi
Electric Automation, Inc.



Mexico FA Center
Querétaro Office, Mitsubishi
Electric Automation, Inc.



Mexico City FA Center
Mexico FA Center
Mexico Branch, Mitsubishi
Electric Automation, Inc.



Brazil FA Center
Mitsubishi Electric do Brasil
Comércio e Serviços Ltda.



Brazil Votorantim FA Center
MELCO CNC do Brasil
Comércio e Serviços S.A.



China

Beijing FA Center
MITSUBISHI ELECTRIC
AUTOMATION (CHINA)LTD.



Tianjin FA Center
MITSUBISHI ELECTRIC
AUTOMATION (CHINA)LTD.



Guangzhou FA Center
MITSUBISHI ELECTRIC
AUTOMATION (CHINA)LTD.



Shanghai FA Center
MITSUBISHI ELECTRIC
AUTOMATION (CHINA) LTD.



Service bases are established around the world to provide the same services as in Japan globally. Overseas bases are opening one after another to support our customers' business expansion.

Area	Our overseas	FA centers
EMEA	26	7
China	17	4
Asia	31	13
Americas	15	6
Others	1	0
Total	90	30

·As of July 2017

MEMO

•Trademarks

MODBUS is a registered trademark of SCHNEIDER ELECTRIC USA, INC.

Ethernet is a registered trademark of Fuji Xerox Corporation in Japan.

Windows and Windows Vista are registered trademarks of Microsoft Corporation in the United States and other countries.

Other company and product names herein are the trademarks and registered trademarks of their respective owners.

 **Safety Warning**

To ensure proper use of the products listed in this catalog, please be sure to read the instruction manual prior to use.

YOUR SOLUTION PARTNER

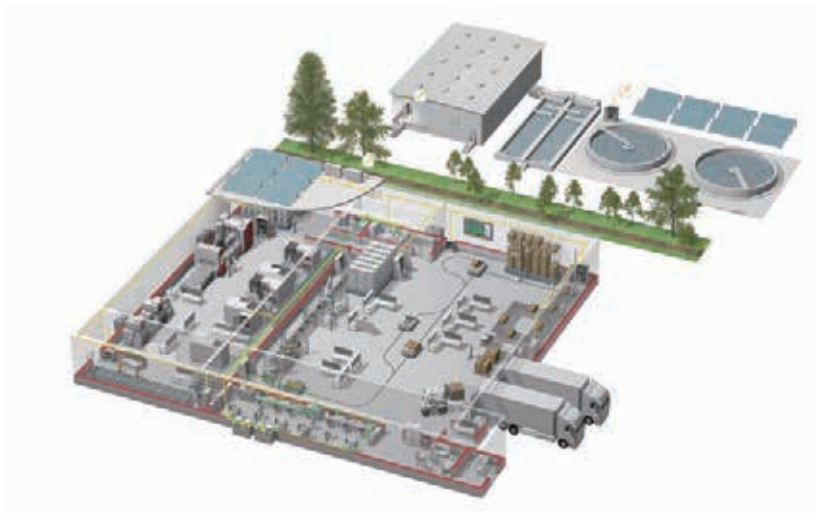

Mitsubishi Electric offers a wide range of automation equipment from PLCs and HMIs to CNC and EDM machines.

A NAME TO TRUST

Since its beginnings in 1870, some 45 companies use the Mitsubishi name, covering a spectrum of finance, commerce and industry.

The Mitsubishi brand name is recognized around the world as a symbol of premium quality.

Mitsubishi Electric Corporation is active in space development, transportation, semi-conductors, energy systems, communications and information processing, audio visual equipment and home electronics, building and energy management and automation systems, and has 237 factories and laboratories worldwide in over 121 countries.

This is why you can rely on Mitsubishi Electric automation solution - because we know first hand about the need for reliable, efficient, easy-to-use automation and control in our own factories.

As one of the world's leading companies with a global turnover of over 4 trillion Yen (over \$40 billion), employing over 100,000 people, Mitsubishi Electric has the resource and the commitment to deliver the ultimate in service and support as well as the best products.



Low voltage: MCCB, MCB, ACB



Medium voltage: VCB, VCC



Power monitoring, energy management



Compact and Modular Controllers



Inverters, Servos and Motors



Visualisation: HMIs



Numerical Control (NC)



Robots: SCARA, Articulated arm



Processing machines: EDM, Lasers, IDS



Transformers, Air conditioning, Photovoltaic systems

* Not all products are available in all countries.

Mitsubishi Electric Corporation Nagoya Works is a factory certified for ISO14001 (standards for environmental management systems) and ISO9001 (standards for quality assurance management systems)

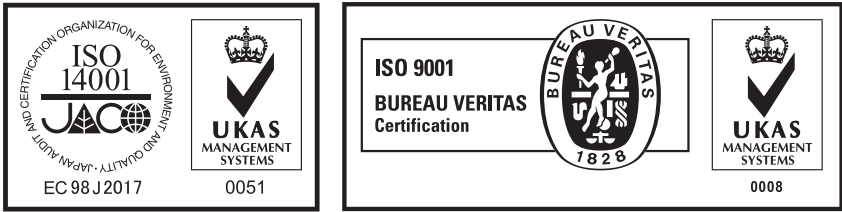

MITSUBISHI ELECTRIC CORPORATION

HEAD OFFICE: TOKYO BLDG., 2-7-3, MARUNOUCHI, CHIYODA-KU, TOKYO 100-8310, JAPAN